

AXOR®

hansgrohe

DE	Gebrauchsanleitung / Montageanleitung	2
FR	Mode d'emploi / Instructions de montage	3
EN	Instructions for use / assembly instructions	4
IT	Istruzioni per l'uso / Istruzioni per Installazione	5
ES	Modo de empleo / Instrucciones de montaje	6
NL	Gebruiksaanwijzing / Handleiding	7
DK	Brugsanvisning / Monteringsvejledning	8
PT	Instruções para uso / Manual de Instalação	9
PL	Instrukcja obsługi / Instrukcja montażu	10
CS	Návod k použití / Montážní návod	11
SK	Návod na použitie / Montážny návod	12
ZH	用户手册 / 组装说明	13
RU	Руководство пользователя / Инструкция по монтажу	14
HU	Használati útmutató / Szerelési útmutató	15
FI	Käyttöohje / Asennusohje	16
SV	Bruksanvisning / Monteringsanvisning	17
LT	Vartotojo instrukcija / Montavimo instrukcijos	18
HR	Upute za uporabu / Uputstva za instalaciju	19
TR	Kullanım kılavuzu / Montaj kılavuzu	20
RO	Manual de utilizare / Instrucțiuni de montare	21
EL	Οδηγίες χρήσης / Οδηγία συναρμολόγησης	22
SL	Navodilo za uporabo / Navodila za montažo	23
ET	Kasutusjuhend / Paigaldusjuhend	24
LV	Lietošanas pamācība / Montāžas instrukcija	25
SR	Uputstvo za upotrebu / Uputstvo za montažu	26
NO	Bruksanvisning / Montasjeveiledning	27
BG	Инструкция за употреба / Инструкция за употреба	28
SQ	Udhëzuesi i përdorimit / Udhëzime rreth montimit	29
AR	دليل الاستخدام / تعليمات التجميع	30

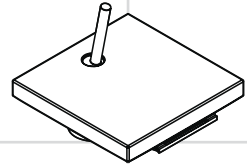

Starck X
10205000

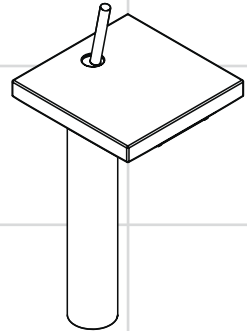

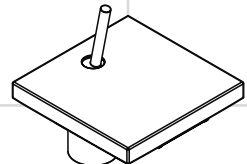

Starck X
10080000 / 10071000 /
10084000



Starck X
10070000 / 10072000 /
10077000



Sicherheitshinweise

-  Bei der Montage müssen zur Vermeidung von Quetsch- und Schnittverletzungen Handschuhe getragen werden.
-  Das Produkt darf nur zu Bade-, Hygiene- und Körperreinigungszwecken eingesetzt werden.
-  Große Druckunterschiede zwischen den Kalt- und Warmwasseranschlüssen müssen ausgeglichen werden.

Montagehinweise

- Die Armatur muss nach den gültigen Normen montiert, gespült und geprüft werden.
- Bei Problemen mit dem Durchlauferhitzer oder wenn mehr Wasserdurchsatz gewünscht wird, kann der EcoSmart® (Durchflussbegrenzer), der hinter dem Luftsprudler sitzt, entfernt werden.
- Hansgrohe Armaturen können in Verbindung mit hydraulisch und thermisch gesteuerten Durchlauferhitzern eingesetzt werden, wenn der Fließdruck mindestens 0,15 MPa beträgt.
- Diese Armatur ist mit einem Schwallstrahl ausgerüstet, der die natürliche Seite des Leberelements Wasser unterstreicht. Da es sich bei einem Schwallstrahl um einen Strahl ohne Luftbeimischung handelt, empfehlen wir zur Vermeidung von Spritzwasser die Verwendung von extra tiefen Waschbecken.
- Die Armaturen werden serienmäßig mit einem Strahlformer mit breitem Schwallstrahl ausgeliefert. Für ein alternatives Strahlbild ist ein Luftsprudler mit einem runden Laminarstrahl beigelegt, der leicht vor Ort umgerüstet werden kann (siehe Seite 33).

Technische Daten

Armatur serienmäßig mit EcoSmart®

(Durchflussbegrenzer)

Betriebsdruck: max. 1 MPa

Empfohlener Betriebsdruck: 0,1 – 0,5 MPa

Prüfdruck: 1,6 MPa

(1 MPa = 10 bar = 147 PSI)

Heißwassertemperatur: max. 80 °C

Empfohlene Heißwassertemperatur: 65 °C

Symbolerklärung



Kein essigsäurehaltiges Silikon verwenden!



Maße (siehe Seite 34)



Durchflussdiagramm
(siehe Seite 34)

① mit EcoSmart®

② ohne EcoSmart®



Serviceteile (siehe Seite 36)



Sonderzubehör

Montageschlüssel (58085000) nicht im Lieferumfang enthalten



Installationskit nicht im Lieferumfang enthalten



Bedienung (siehe Seite 38)



Reinigung (siehe Seite 37) und beiliegende Broschüre





Prüfzeichen (siehe Seite 38)



Montage siehe Seite 31



Consignes de sécurité

-  Lors du montage, porter des gants de protection pour éviter toute blessure par écrasement ou coupure.
-  Le système de douche ne doit servir qu'à se laver et à assurer l'hygiène corporelle.
-  Il est conseillé d'équilibrer les pressions de l'eau chaude et froide.

Instructions pour le montage

- La robinetterie doit être installée, rincée et contrôlée conformément aux normes valables.
- En cas de problèmes avec le chauffe-eau, ou bien si le débit d'eau doit être plus important, il est possible d'enlever l'EcoSmart® (limiteur de débit) se trouvant derrière l'aérateur.
- Les mitigeurs Hansgrohe fonctionnent également en association à des chauffe-eau à commande hydraulique ou thermique à condition que la pression soit au minimum de 0,15 MPa.
- Cette robinetterie est pourvue d'un jet d'eau soulignant le côté naturel de cet élément vital qu'est l'eau. Ce jet d'eau n'étant pas additionné d'air, nous recommandons son utilisation pour les lavabos particulièrement profonds, afin d'éviter toute éclaboussure.
- Les robinetteries sont équipées d'origine d'une lame d'eau orientable. Pour une autre alternative de forme de jet, il est joint un aérateur rond avec jet standard qui peut être changé facilement sur place (voir page 33).

Informations techniques

Robinetterie équipée en série d'un EcoSmart® (limiteur de débit)

Pression de service autorisée:	max. 1 MPa
Pression de service conseillée:	0,1 - 0,5 MPa
Pression maximum de contrôle: (1 MPa = 10 bar = 147 PSI)	1,6 MPa
Température d'eau chaude:	max. 80 °C
Température recommandée:	65 °C

Description du symbole



Ne pas utiliser de silicone contenant de l'acide acétique!



Dimensions (voir page 34)



Diagramme du débit
(voir page 34)

- ① avec EcoSmart®
- ② sans EcoSmart®



Pièces détachées (voir pages 36)



Special accessories

clé de montage (58085000) ne fait pas partie de la fourniture



Mastic d'installation ne fait pas partie de la fourniture



Instructions de service (voir page 38)



Nettoyage (voir page 37) et brochure ci-jointe





Classification acoustique et débit (voir page 38)



Montage voir page 31



Safety Notes

-  Gloves should be worn during installation to prevent crushing and cutting injuries.
-  The shower system may only be used for bathing, hygienic and body cleansing purposes.
-  The hot and cold supplies must be of equal pressures.

Installation Instructions

- The fitting must be installed, flushed and tested after the valid norms.
- If the instantaneous water heater causes problems or if you wish to increase the water flow, the EcoSmart® (flow limiter) located behind the aerator can be removed.
- Hansgrohe mixers can be used together with hydraulically and thermally controlled continuous flow heaters if the flow pressure is at least 0,15 MPa.
- This mixer is equipped with a flush stream, which enhances the natural side of the life element water. As this flush stream does not contain any air, we recommend the use of very deep basins to prevent water spray.
- This mixer series is produced with the following spray pattern - with the spray former with a waterfall. For an alternative spray, an aerator with a round monospray, that can be changed easily on the spot, is enclosed (see page 33).

Technical Data

This mixer series-produced with EcoSmart® (flow limiter)

Operating pressure:	max. 1 MPa
Recommended operating pressure:	0,1 - 0,5 MPa
Test pressure:	1,6 MPa
(1 MPa = 10 bar = 147 PSI)	
Hot water temperature:	max. 80 °C
Recommended hot water temp.:	65 °C

Symbol description



Do not use silicone containing acetic acid!



Dimensions (see page 34)



Flow diagram
(see page 34)

- ① with EcoSmart®
- ② without EcoSmart®



Spare parts (see page 36)



Special accessories

special tool (58085000) order as an extra



Installation kit order as an extra

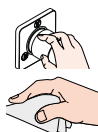

Operation (see page 38)



Cleaning (see page 37) and enclosed brochure



Test certificate (see page 38)



Assembly see page 31



Indicazioni sulla sicurezza

-  Durante il montaggio, per pevitare ferite da schiacciamento e da taglio bisogna indossare guanti protettivi.
-  Il sistema doccia deve essere utilizzato esclusivamente per l'igiene del corpo.
-  Attenzione! Compensare le differenze di pressione tra i collegamenti dell'acqua fredda e dell'acqua calda.

Istruzioni per il montaggio

- La rubinetteria deve essere installata, pulita e testata secondo le istruzioni riportate!
- Nel caso di problemi con lo scalda-acqua oppure nel caso si desiderasse più erogazione, si può eliminare il EcoSmart® (limitatore di flusso) che si trova dietro la valvola di aerazione.
- I miscelatori Hansgrohe possono venire usati con caldaie a "bassa pressione" se la pressione di flusso è almeno di 0,15 MPa.
- Questa rubinetteria è dotata con un getto d'acqua a cascata, il quale evidenzia il lato naturale dell'elemento vitale acqua. Siccome si tratta di un getto d'acqua a cascata senza aggiunta di aria, per evitare spruzzi d'acqua raccomandiamo l'impiego di lavandini extra profondi.
- La rubinetteria viene consegnata in serie con un diffusore con getto d'acqua a cascata larga. Per ottenere un getto d'acqua alternativo è incluso un rompigetto con un getto d'acqua con forma laminare e rotonda che può essere cambiato in modo semplice direttamente sul posto (vedi pagg. 33).

Dati tecnici

Questo miscelatore è dotato di serie del EcoSmart® (limitatore di flusso)

Pressione d'uso:	max. 1 MPa
Pressione d'uso consigliata:	0,1 - 0,5 MPa
Pressione di prova:	1,6 MPa
(1 MPa = 10 bar = 147 PSI)	
Temperatura dell'acqua calda:	max. 80 °C
Temp. dell'acqua calda consigliata:	65 °C

Descrizione simbolo



Non utilizzare silicone contenente acido acetico!



Ingombri (vedi pagg. 34)



Diagramma flusso
(vedi pagg. 34)

- ① con EcoSmart®
- ② senza EcoSmart®



Parti di ricambio (vedi pagg. 36)



Accessori speciali

chiave per montaggio (58085000) non contenuto nel volume di fornitura



Mastice d'installazione non contenuto nel volume di fornitura

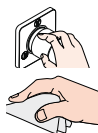

Procedura (vedi pagg. 38)



Pulitura (vedi pagg. 37) e brochure allegata



Segno di verifica (vedi pagg. 38)



Montaggio vedi pagg. 31



Indicaciones de seguridad

- ⚠ Durante el montaje deben utilizarse guantes para evitar heridas por aplastamiento o corte.
- ⚠ La grifería solo debe ser utilizada para fines de baño, higiene y limpieza corporal.
- ⚠ Grandes diferencias de presión en servicio entre agua fría y agua caliente deben equilibrarse.

Indicaciones para el montaje

- El grifo tiene que ser instalado, probado y testado, según las normas en vigor.
- En caso de problemas con el calentador instantáneo o cuando se desee más caudal de agua puede quitarse el EcoSmart® (limitador de caudal), situado detrás del aireador.
- Los mezcladores Hansgrohe pueden ser utilizados junto con calentadores continuos de agua que sean manejados de manera hidráulica o térmica, siempre que la presión en servicio ascienda a un mínimo de 0,15 MPa.
- Esta grifería está equipada con un chorro suave que resalta el aspecto natural del agua como elemento vital. Como un chorro suave es un chorro sin mezcla de aire, para evitar salpicaduras de agua recomendamos el uso de lavabos profundos.
- Las guarniciones se suministran en serie con un dispositivo moldeador con un amplio chorro. Si se desea otra forma de chorro se ha incluido un dispositivo burbujeador de aire con un chorro laminar y circular que se puede montar fácilmente en el mismo lugar de la instalación (ver página 33).

Datos técnicos

Grifo, desde fábrica equipado con EcoSmart®

(limitador de caudal)

Presión en servicio: max. 1 MPa

Presión recomendada en servicio: 0,1 - 0,5 MPa

Presión de prueba: 1,6 MPa

(1 MPa = 10 bar = 147 PSI)

Temperatura del agua caliente: max. 80 °C

Temp. recomendado del agua caliente: 65 °C

Descripción de símbolos



No utilizar silicona que contiene ácido acético!



Dimensiones (ver página 34)



Diagrama de circulación (ver página 34)

① con EcoSmart®

② sin EcoSmart®



Repuestos (ver página 36)



Opcional

Llave de montaje (58085000) no incluido en el suministro



Masilla no incluido en el suministro



Manejo (ver página 38)



Limpiar (ver página 37) y folleto anexo





Marca de verificación (ver página 38)





Veiligheidsinstructies

-  Bij de montage moeten ter voorkoming van kniel- en snijwonden handschoenen worden gedragen.
-  Het douchesysteem mag alleen voor het wassen, hygiënische doeleinden en voor de lichaamreiniging worden gebruikt.
-  Grote drukverschillen tussen de kouden warm wateraansluitingen dienen vermeden te worden.

Montage-instructies

- Leidingen doorspoelen volgens Norm. De mengkraan vervolgens monteren en controleren.
- Wanneer problemen optreden bij doorloopgeisers of wanneer een grotere waterdoorvoer gewenst is, kan de EcoSmart® (doorstroombegrenzer) die achter de perlator is gemonteerd, makkelijk verwijderd worden.
- Hansgrohe kranen kunnen samen met hydraulisch en thermisch gestuurde geisers gebruikt worden indien de uitstroomdruk min. 0,15 MPa bedraagt.
- Deze kraan is uitgerust met een watervalstraal die het natuurlijke aspect van het levenselement water benadrukt. Aangezien het bij een watervalstraal gaat om een straal waaraan geen lucht wordt toegevoegd, bevelen wij het gebruik van extra diepe wastafels aan om spatwater te vermijden.
- De kranen worden seriematig met een straalvormer met een brede Schwallstraal uitgeleverd. Voor een alternatief straalbeeld is een perlator meegeleverd die een ronde met lucht verrijkte waterstraal geeft. Deze kan eenvoudig ter plekke worden omgewisseld (zie blz. 33).

Technische gegevens

Armatuur standaard met EcoSmart®

(doorstroombegrenzer)

Werkdruk: max.	max. 1 MPa
Aanbevolen werkdruk:	0,1 - 0,5 MPa
Getest bij:	1,6 MPa
(1 MPa = 10 bar = 147 PSI)	
Temperatuur warm water:	max. 80 °C
Aanbevolen warm water temp.:	65 °C

Symboolbeschrijving



Gebruik geen zuurhoudende silicone!



Maten (zie blz. 34)



Doorstroombegrenzer
(zie blz. 34)

- ① met EcoSmart®
- ② zonder EcoSmart®



Service onderdelen (zie blz. 36)



Toebehoren

montagesleutel (58085000) behoort niet tot het leveringspakket



Kit behoort niet tot het leveringspakket



Bediening (zie blz. 38)



Reinigen (zie blz. 37) en
bijgevoegde brochure



Keurmerk (zie blz. 38)



Montage zie blz. 31



Sikkerhedsanvisninger

- △ Ved monteringen skal der bruges handsker for at undgå kvæstelser og snitsår.
- △ Brusersystemet må kun bruges til bade-, hygiejne og rengøringsformål.
- △ Større trykforskelle mellem koldt og varmt vand bør udjævnes.

Monteringsanvisninger

- Ifølge gældende regler, skal armaturet monteres, skylles igennem og afprøves.
- Ved problemer med gennemløbsvandvarmer eller hvis der ønskes mere vandgennemstrømning, kan EcoSmart® (gennemstrømningsbegrænseren), der sidder i perlatoren, fjernes.
- Hansgrohe armaturer kan anvendes i forbindelse med hydraulisk- og termiskstyrede gennemstrømningsvandarmere ved et vandtryk på 0,15 MPa.
- Armaturet er udstyret med en vandfalds-stråle, som understreger den naturlige side af anvende som livselement. Fordi en vandfalds-stråle er en stråle uden tilsætning af luft, anbefaler vi at anvende særlig dybe vandfade, for at undgå stænkevand.
- Armaturerne leveres som standard med en perlator med den brede vandfalds-stråle. Som alternativ medfølger en perlator med almindelig stråle, der enkelt kan udskiftes (se s. 33).

Tekniske data

Armaturet er forsynet med EcoSmart® (gennemstrømningsbegrænsere)

Driftstryk:	max. 1 MPa
Anbefalet driftstryk:	0,1 – 0,5 MPa
Prøvetryk:	1,6 MPa
(1 MPa = 10 bar = 147 PSI)	
Varmtvandstemperatur:	max. 80 °C
Anbefalet varmtvandstemperatur:	65 °C

Symbolbeskrivelse



Der må ikke benyttes eddikesyreholdig silikone!



Målene (se s. 34)



Gennemstrømningsdiagram (se s. 34)

- ① med EcoSmart®
- ② uden EcoSmart®



Reserve dele (se s. 36)



Specialtilbehør

Monteringsnøgle (58085000) ikke med i leveringsomfang



Kitt ikke med i leveringsomfang



Bediening (se s. 38)





Rengøring (se s. 37) og vedlagt brochure

Godkendelse (se s. 38)





Avisos de segurança

-  Durante a montagem devem ser utilizadas luvas de protecção, de modo a evitar ferimentos resultantes de entalamentos e de cortes.
-  O sistema de duche só pode ser utilizado para fins de higiene pessoal.
-  Grandes diferenças entre as pressões das águas quente e fria devem ser compensadas.

Avisos de montagem

- A misturadora deve ser instalada, purgada e testada de acordo com as normas em vigor.
- Em caso de problemas com o esquentador de água ou se desejar maior débito de água, é possível retirar o EcoSmart® (limitador de caudal), situado por trás do emulsor.
- As misturadoras Hansgrohe podem ser utilizadas com esquentadores (de controlo térmico ou hidráulico) desde que a pressão de utilização seja, no mínimo, de 0,15 MPa.
- Esta misturadora está equipada com um emulsor de spray de cascata que sublinha a característica natural do elemento vital, a água. Visto tratar-se de um emulsor de spray em cascata, sem adição de ar, recomendamos a utilização de lavatórios especialmente fundos, de modo a evitar salpicos de água.
- Esta linha de misturadoras é produzida de série com um emulsor de spray de cascata. Para um spray alternativo, incluso está um emulsor com um spray monocircular que pode ser facilmente trocado na bica (ver página 33).

Dados Técnicos

Misturadoras produzidas em série com EcoSmart® (limitador de caudal)

Pressão de funcionamento:	max. 1 MPa
Pressão de func. recomendada:	0,1 – 0,5 MPa
Pressão testada:	1,6 MPa
(1 MPa = 10 bar = 147 PSI)	
Temperatura da água quente:	max. 80 °C
Temp. água quente recomendada:	65 °C

Descrição do símbolo



Não utilizar silicone que contenha ácido acético!



Medidas (ver página 34)



Fluxograma
(ver página 34)

- ① com EcoSmart®
- ② sem EcoSmart®



Peças de substituição (ver página 36)



Acessórios especiais

Chave especial (58085000) não incluído no volume de fornecimento



Mástique não incluído no volume de fornecimento



Funcionamento (ver página 38)



Limpeza (ver página 37) e brochura em anexo





Marca de controlo (ver página 38)





Wskazówki bezpieczeństwa

-  Aby uniknąć zranień, takich jak zgniecenia czy przecięcia, podczas montażu należy nosić rękawice.
-  Pysznic może być używany tylko do kąpieli, higieny i czyszczenia ciała.
-  Znaczne różnice ciśnień na dopływach ciepłej i zimnej wody muszą zostać wyrównane.

Wskazówki montażowe

- Armatura musi być zamontowana, przepłukana i wypróbowana według obowiązujących norm.
- W przypadku problemów z przepływowymi podgrzewaczami wody lub jeśli chce się uzyskać większy przepływ wody, można usunąć EcoSmart® (ogranicznik przepływu) znajdujący się za napowietrzaczem.
- Armatura Hansgrohe może być stosowana z przepływowymi podgrzewaczami wody sterowanymi hydraulicznie i termicznie w przypadku, gdy ciśnienie przepływu wynosi co najmniej 0,15 MPa.
- Armatura ta wyposażona jest w strumień wachlarzowy, który podkreśla naturalną stronę wody jako elementu życia. Ze względu na to, iż w przypadku strumienia wachlarzowego chodzi o strumień bez domieszki powietrza, zaleca się do uniknięcia wody rozpryskowej używanie wyjątkowo głębokiej umywalki.
- Armatura jest seryjnie wyposażona w kształtownik strumienia o szerokim strumieniu wachlarzowym. Jako rozwiązanie alternatywne w komplecie dostarczony jest napowietrzacz o strumieniu okrągłym, który może zostać łatwo wymieniony po montażu (patrz strona 33).

Dane techniczne

Armatura produkowana seryjnie z funkcją EcoSmart® (ogranicznik przepływu)

Ciśnienie robocze:	maks. 1 MPa
Zalecane ciśnienie robocze:	0,1 - 0,5 MPa
Ciśnienie próbne:	1,6 MPa
(1 MPa = 10 bary = 147 PSI)	
Temperatura wody gorącej:	maks. 80 °C
Zalecana temperatura wody gorącej:	65 °C

Opis symbolu



Nie stosować silikonów zawierających kwas octowy!



Wymiary (patrz strona 34)



Schemat przepływu (patrz strona 34)

- ① z EcoSmart®
- ② bez EcoSmart®



Części serwisowe (patrz strona 36)



Wyposażenie specjalne

Klucz montażowy (58085000) Nie jest częścią dostawy



Kit instalatorski Nie jest częścią dostawy



Obsługa (patrz strona 38)



Czyszczenie (patrz strona 37) i dołączona broszura





Znak jakości (patrz strona 38)



Montaż patrz strona 31



Bezpečnostní pokyny

-  Pro zabránění řezným zraněním a pohmožděninám je nutné při montáži nosit rukavice.
-  Produkt smí být používán pouze ke koupání a za účelem tělesné hygieny.
-  Je nutné vyrovnat velké rozdíly tlaku mezi přípoji studené a teplé vody.

Pokyny k montáži

- Armatura se musí montovat, proplachovat a testovat podle platných norem.
- Při problémech s průtokovým ohřivačem, nebo když je požadován větší průtok, může být odstraněno zařízení EcoSmart® (omezovač průtoku), které je umístěno za perlátorem.
- Armatury Hansgrohe je možno používat v kombinaci s hydraulicky a tepelně řízenými průtokovými ohřivači v případě, že tlak činí minimálně 0,15 MPa.
- Tato armatura je vybavena usměrněným proudem vody, který podtrhuje přírodní podstatu životně důležitého elementu - vody. Protože se u tohoto usměrněného proudu vody jedná o proud bez obsahu vzduchu, doporučujeme pro zabránění rozstříkávání vody používání extra hlubokého umyvadla.
- Armatury jsou sériově dodávány s tvarovačem proudu s širokým přivalovým proudem. Pro alternativní tvar proudu je přiložen perlátor s okrouhlým laminárním proudem, který je možno snadno vyměnit na místě (viz strana 33).

Technické údaje

Armatura je sériově vybavena zařízením

EcoSmart® (omezovač průtoku)

Provozní tlak:	max. 1 MPa
Doporučený provozní tlak:	0,1 – 0,5 MPa
Zkušební tlak:	1,6 MPa
(1 MPa = 10 bar = 147 PSI)	
Teplota horké vody:	max. 80 °C
Doporučená teplota horké vody:	65 °C

Popis symbolů



Nepoužívat silikon s obsahem kyseliny octové!



Rozměry (viz strana 34)



Diagram průtoku
(viz strana 34)

- ① se zařízením EcoSmart®
- ② bez zařízení EcoSmart®



Servisní díly (viz strana 36)



Zvláštní příslušenství

montážní klíč (58085000) není součástí dodávky



Instalační kit není součástí dodávky



Ovládání (viz strana 38)



Čištění (viz strana 37) a přiložená brožura





Zkušební značka (viz strana 38)





Bezpečnostné pokyny

-  Pri montáži musíte nosiť rukavice, aby ste predišli pomliaždeninám a rezným poraneniam.
-  Produkt sa smie používať len na kúpanie a telesnú hygienu.
-  Veľké rozdiely v tlaku medzi prípojkami studenej a teplej vody musia byť vyrovnané.

Pokyny pre montáž

- Armatúra sa musí montovať, preplachovať a testovať podľa platných noriem.
- Pri problémoch s prietokovým ohrievačom alebo ak je požadovaný väčší prietok vody, môže sa demontovať zariadenie EcoSmart® (obmedzovač prietoku), ktoré je umiestnené za perlátorom.
- Batérie Hansgrohe môžete používať v spojení s hydraulickými a tepelne ovládanými prietokovými ohrievačmi, ak je tlak minimálne 0,15 MPa.
- Táto armatúra je vybavená príválovým prúdom, ktorý zdôrazňuje prirodzenú stránku prírodného živlu, vody. Keďže sa pri tomto príválovom prúde jedná o prúd bez primiešania vzduchu, odporúčame použiť extra hlboké umývadlo, aby ste zabránili špliechaniu vody.
- Batérie budú sériovo dodané s tvarovačom prúdu so širokým prúdom vody. Pre alternatívny tvar prúdu je určený perlátor s kruhovým laminárnym prúdom, ktorý sa môže jednoducho namontovať na mieste (viď strana 33).

Technické údaje

Armatúra je sériovo vybavená zariadením

EcoSmart® (obmedzovač prietoku)

Prevádzkový tlak:	max. 1 MPa
Doporučený prevádzkový tlak:	0,1 – 0,5 MPa
Skúšobný tlak:	1,6 MPa
(1 MPa = 10 bar = 147 PSI)	
Teplota teplej vody:	max. 80 °C
Doporučená teplota teplej vody:	65 °C

Popis symbolov



Nepoužívať silikón s obsahom kyseliny octovej!



Rozmery (viď strana 34)



Diagram prietoku
(viď strana 34)

- ① so zariadením EcoSmart®
- ② bez zariadenia EcoSmart®



Servisné diely (viď strana 36)



Zvláštne príslušenstvo

montážny kľúč (58085000) nie je súčasťou dodávky



Inštalčná súprava nie je súčasťou dodávky



Obsluha (viď strana 38)



Čistenie (viď strana 37) a priložená brožúra



Osvedčenie o skúške (viď strana 38)



Montáž vid' strana 31



⚠️ 安全技巧

- △ 装配时为避免挤压和切割受伤，必须戴上手套。
- △ 淋浴系统只允许作为洗浴、卫生和洁身之用。
- △ 冷热水管间过大的压力差必须予以平衡。

安装提示

- 必须按照现行的规定安装，冲洗和测试产品。
- 如果使用即热式热水器时出现问题，或要求更大的水流量，可以把位于水波器后面的 EcoSmart® (流量限制器) 拆除。
- 如果水压达到0,15 MPa以上，汉斯格雅双手柄龙头可以和液压式或热控式连续流热水器一起使用。
- 该阀门配备了一个扁平式喷水装置，这个扁平式喷水装置着重强调了水是生命元素的自然形态。由于扁平式喷水装置的水流中没有混合空气，为了避免喷水，我们建议使用特别的深水盆。
- 龙头系列采用下列喷口图案—带有喷雾形成器及瀑布。对于可选择的喷头，附带一个带有圆形单喷头的水波器，其可以很容易地在现场更换。(参见第 33 页)

技术参数

本龙头配有 EcoSmart® (流量限制器)

工作压强:	最大 1 MPa
推荐工作压强:	0,1 0,5 MPa
测试压强:	1,6 MPa
(1 MPa = 10 bar = 147 PSI)	
热水温度:	最大 80° C
推荐热水温度:	65° C

符号说明



请勿使用含有乙酸的硅!



大小 (参见第 34 页)



流量示意图
(参见第 34 页)

- ① 带有 EcoSmart®
- ② 无 EcoSmart®



备用零件 (参见第 36 页)



选装附件

专用工具 (58085000) 不在供货范围内



水管胶泥 不在供货范围内



操作 (参见第 38 页)



清洗 (参见第 37 页) 并附有小手册





检验标记 (参见第 38 页)



安装 参见第 31 页



Указания по технике безопасности

-  Во время монтажа следует надеть перчатки во избежание прищемления и порезов.
-  Изделие разрешается использовать только в гигиенических целях: для принятия ванны и личной гигиены.
-  донного клапа. Перед установкой смесителя необходимо регулировочными кранами выровнять давление холодной и горячей воды при помощи вентилей регулирующих подачу воды в квартиру.

Указания по монтажу

- Смеситель должен быть смонтирован по действующим нормам и в соответствии с настоящей инструкцией, проверен на герметичность и безупречность работы.
- Если возникнут проблемы с проточным бойлером или потребуется увеличить расход воды, то можно удалить EcoSmart® (ограничитель потока воды), который установлен за воздушным рассекателем.
- Арматуры Hansgrohe могут использоваться в комбинации с проточными нагревателями с гидравлическим и термическим управлением, если давление истечения составляет не менее 0,15 МПа.
- Эта арматура оснащена специальной распылительной насадкой, которая подчеркивает естественные стороны воды как одного из природных элементов. В распылительной насадке не происходит примешивания воздуха, поэтому во избежание брызг воды рекомендуется использовать раковину увеличенной глубины.
- Арматуры серийно выпускаются с формирователем широкой струи. Для получения альтернативного типа струи прилагается аэратор с круглой ламинарной струей, который с легкостью можно заменить на месте (см. стр. 33).

Технические данные

Смесители этой серии серийно оснащаются EcoSmart® (ограничителем потока воды)

Рабочее давление:	не более. 1 МПа
Рекомендуемое рабочее давление:	0,1 – 0,5 МПа
Давление:	1,6 МПа
(1 МПа = 10 bar = 147 PSI)	
Температура горячей воды:	не более. 80 °С
Рекомендуемая темп. гор. воды:	65 °С

Описание символов



Не применяйте силикон, содержащий искусственную кислоту.



Размеры (см. стр. 34)



Схема потока
(см. стр. 34)

- ① С EcoSmart®
- ② Без EcoSmart®



Комплект (см. стр. 36)



Специальные принадлежности

Монтажный ключ (58085000) не включено в объем поставки!



Монтаж подводки не включено в объем поставки!



Эксплуатация (см. стр. 38)



Очистка (см. стр. 37) и прилагаемая брошюра





Знак технического контроля
(см. стр. 38)



Монтаж см. стр. 31



Biztonsági utasítások

-  A szerelésnél a zúzódások és vágási sérülések elkerülése érdekében kesztyűt kell viselni.
-  A terméket csak fürdéshez, mosakodáshoz, és egészségügyi tisztálkodáshoz szabad használni.
-  A hidegvíz- és a melegvíz-csatlakozások közötti nagy nyomáskülönbséget kikell egyenlíteni!

Szerelési utasítások

- A csaptelepet az érvényben lévő előírásoknak megfelelően kell felszerelni, átöblíteni és ellenőrizni.
- Ha problémák adódnak az átfolyós vízmelegítővel vagy nagyobb átfolyó vízmennyiségre van szükség, akkor az EcoSmart® (átfolyáskorlátozó) eltávolítható a perlátor mögül.
- A Hansgrohe csaptelepek hidraulikus és termikus vezérlésű átfolyós melegítőkkel kapcsolatban is használhatóak, ha az átfolyó nyomás legalább 0,15 MPa.
- Ez a csaptelep szélesen ömlő vízszaggárral van ellátva, amely kiemeli a víz lételelem természetes oldalát. Mivel a szélesen ömlő vízszaggár levegő hozzákeverés nélküli vízszagat jelent ajánljuk, hogy a fröccsenővíz elkerülése érdekében extra mély mosdót használjon.
- A csaptelepeket gyárilag széles vízszaggárt adó szaggárformálóval szállítják. Alternatív szaggárképhez kerek áramlósugarat adó perlátort mellékelünk, ami a helyszínen könnyedén átszerelhető (lásd a 33. oldalon).

Műszaki adatok

A csaptelep szériakivitelben el van látva EcoSmart® (átfolyáskorlátozó) berendezéssel

Üzemi nyomás:	max. 1 MPa
Ajánlott üzemi nyomás:	0,1 – 0,5 MPa
Nyomáspróba:	1,6 MPa
(1 MPa = 10 bar = 147 PSI)	
Forróvíz hőmérséklet:	max. 80 °C
Forróvíz javasolt hőmérséklete:	65 °C

Szimbólumok leírása



Ne használjon ecetsavtartalmú szilikon!



Méretet (lásd a 34. oldalon)



Átfolyási diagramm (lásd a 34. oldalon)

- ① EcoSmart® berendezéssel
- ② EcoSmart® nélkül



Tartozékok (lásd a 36. oldalon)



Egyéb tartozék

Szerelőkulcs (58085000) a szállítási egység nem tartalmazza



szaniter szilikon a szállítási egység nem tartalmazza



Használat (lásd a 38. oldalon)



Tisztítás (lásd a 37. oldalon) és mellékelt brossúrával



Vizsgajel (lásd a 38. oldalon)



Szerelés lásd a 31. oldalon



Turvallisuusohjeet

- ⚠ Asennuksessa on käytettävä käsineitä puristumien ja viiltojen aiheuttamien tapaturmien estämiseksi.
- ⚠ Suihkujärjestelmää saa käyttää ainoastaan kylpy-, hygienia- ja puhdistustarkoituksiin.
- ⚠ Suuret paine-erot kylmä- ja kuumavesiliitäntöjen välillä on tasattava.

Asennusohjeet

- Kaluste on asennettava, huuhdeltava ja tarkastettava voimassa olevien määräysten mukaisesti.
- Jos läpivirtauskuumentimen kanssa on ongelmia tai jos halutaan suurempaa veden virtausmäärää, voidaan poreenmuodostajan takana oleva EcoSmart® (virtauksenrajoitin) poistaa.
- Hansgrohe kalusteita voi käyttää hydraulisesti tai termisesti ohjattujen läpivirtauskuumentimien yhteydessä, jos virtauspaine on vähintään 0,15 MPa.
- Tämä armatuuri on varustettu putousmaisella vesisuihkulla, joka korostaa elintärkeän elementin, veden luonnollista ominaisuutta. Koska putousmaisessa vesisuihkussa on kyse vesisuihkusta, johon ei ole sekoitettu ilmaa, suosittelemme suosittelemme roiskeveden estämiseksi erityisen syviä pesuallaita.
- Kalusteet toimitetaan vakiona vesisuihkun muotoilijalla, joka tuottaa yhden leveän vesivirran. Vaihtoehtoista vesisuihkun muotoa varten mukaan on liitetty pyöreän, pyörteettömän suihkukuvion tuottava poresuutin, joka on helppo paikan päällä laittaa paikalleen (katso sivu 33).

Tekniset tiedot

Kaluste on vakiona varustettu EcoSmart®

(virtauksenrajoittimella)

Käyttöpaine:	maks. 1 MPa
Suosittelut käyttöpaine:	0,1 – 0,5 MPa
Koestuspaine:	1,6 MPa (1 MPa = 10 bar = 147 PSI)
Kuuman veden lämpötila:	maks. 80 °C
Kuuman veden suosituslämpötila:	65 °C

Merkin kuvaus



Älä käytä etikkahappopitoista silikonia!



Mitat (katso sivu 34)



Virtausdiagrammi
(katso sivu 34)

- ① sisältää EcoSmart®
- ② ilman EcoSmart®



Varaosat (katso sivu 36)



Erytisvaruste

Asennusavain (58085000) ei kuulu toimitukseen



Asennussarja ei kuulu toimitukseen



Käyttö (katso sivu 38)



Puhdistus (katso sivu 37) ja oheinen esite





Koestusmerkki (katso sivu 38)





Säkerhetsanvisningar

-  Handskar ska bäras under monteringsarbetet så att man kan undvika kläm- och skärskadorgen werden.
-  Produkten får bara användas till kroppshygien med bad och dusch.
-  Stora tryckskillnader mellan anslutningarna för varmt och kallt vatten måste utjämnas.

Monteringsanvisningar

- Armaturen måste installeras, genomspolas och testas enligt gällande föreskrifter.
- Om det är problem med vattenberedaren eller om större vattenflöde önskas kan EcoSmart® (flödeskontroll) som sitter bakom perlatorn tas bort.
- Hansgrohe blandare kan användas tillsammans med hydrauliskt och termiskt styrda varmvattenberedare när flödestrycket uppgår till minst 0,15 MPa.
- Blandaren är utrustad med en svallstråle som understryker naturligheten hos livselementet vatten. Eftersom en svallstråle är en stråle utan lufttillsats rekommenderar vi att extra djupa tvättställ används så att stänkvatten kan undvikas.
- Blandarna levereras seriemässigt med bred svallstråle. En areator, enkel att montera på plats, med rund laminarstråle medföljer för att göra det möjligt att få en alternativ strålbild (se sidan 33).

Tekniska data

Blandare seriemässigt med EcoSmart® (flödeskontroll)

Driftstryck:	max. 1 MPa
Rek. driftstryck:	0,1 – 0,5 MPa
Tryck vid provtryckning: (1 MPa = 10 bar = 147 PSI)	1,6 MPa
Varmvattentemperatur:	max. 80 °C
Rek. varmvattentemp.:	65 °C

Simbolio aprašymas



Använd inte silikon som innehåller ättiksyra!



Måtten (se sidan 34)



Pralaidumo diagrama
(se sidan 34)

- ① med EcoSmart®
- ② utan EcoSmart®



Reservdelar (se sidan 36)



Specialtillbehör

Monteringsnyckel (58085000) medföljer ej leveransen



Installationskit medföljer ej leveransen

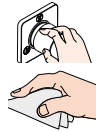

Hantering (se sidan 38)





Rengöring (se sidan 37) och medföljande broschyr

Testsgill (se sidan 38)





Saugumo technikos nurodymai

-  Apsaugai nuo užspaudimo ir įsijpavimo montavimo metu mūvėkite pirštines.
-  Gaminys turi būti naudojamas tik maudymuisi, kūno higienai ir švarai palaikyti.
-  Turi būti išlyginti šalto ir karšto slėgio nelygumai.

Montavimo instrukcija

- Maišytuvas privalo būti montuojamas ir išbandomas pagal veikiančias normas ir šią instrukciją.
- Jei yra problemų su momentiniu vandens šildytuvu ar neužtenka vandens srauto, galima pašalinti už aeratoriaus esantį „EcoSmart®“ (vandens srauto ribotuvą).
- „Hansgrohe“ maišytuvai gali būti naudojami su hidrauliškai ir termiškai reguliuojamais momentiniais šildikliais, kai vandens slėgis mažesnis kaip 0,15 MPa.
- Šioje įrangoje yra įrengta srautinė vandens srovė, kuri pabrėžia vandens kaip gyvybės elemento natūraliąją pusę. Kadangi srautinė vandens srovė yra srovė be oro, rekomenduojame naudoti itin gilius vandens kriaukles, kad būtų išvengta tikštančio vandens.
- Maišytuvai yra siūlomi su plačia srove (kriokliai). Alternatyviam srovės tipui yra siūlomas oro kompresorius su apvalia srove (žr. psl. 33).

Techniniai duomenys

Šios serijos maišytuvai turi EcoSmart® (vandens srauto ribotuvą)

Darbinis slėgis: ne daugiau kaip 1 MPa

Rekomenduojamas slėgis: 0,1 – 0,5 MPa

Bandomasis slėgis: 1,6 MPa

(1 MPa = 10 barų = 147 PSI)

Karšto vandens temperatūra: ne daugiau kaip 80 °C

Rekomenduojama karšto vandens temperatūra: 65 °C

Simbolio aprašymas



Nenaudokite silikono, kurio sudėtyje yra acto rūgšties!



Išmatavimai (žr. psl. 34)



Pralaidumo diagrama (žr. psl. 34)

- ① su EcoSmart®
- ② be EcoSmart®



Atsarginės dalys (žr. psl. 36)



Specialūs priedai

Montavimo raktas (58085000) nėra pridedama



Montavimo rinkinys nėra pridedama

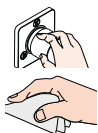

Eksplotacija (žr. psl. 38)

Valymas (žr. psl. 37) ir pridedama brošiūra





Bandyimo pažyma (žr. psl. 38)





Sigurnosne upute

-  Prilikom montaže se radi sprječavanja prignječenja i posjekotina moraju nositi rukavice.
-  Proizvod se smije primjenjivati samo za kupanje, tuširanje i osobnu higijenu.
-  Velika razlika u pritisku između vruće i hladne vode mora biti izbalansirana.

Upute za montažu

- Cijevi moraju biti postavljene, isprane i testirane prema važećim normama.
- Ako dolazi do problema s protočnim bojlerom ili se želi veći protok vode, može se ukloniti EcoSmart® (limitator protoka) lociran iza aeratora.
- Hansgrohe armature mogu se koristiti u kombinaciji sa hidraulički i termički kontroliranim protočnim bojlerima ukoliko tlak iznosi najmanje 0,15 MPa
- Ova je armatura opremljena mlazom za zapljuskivanje koji naglašava prirodnu stranu vode kao životnog elementa. Budući da je kod mlaza za zapljuskivanje radi riječ o mlazu kojemu se ne pridodaju mjehurići vode, preporučujemo ga za primjenu u osobito dubokim umivaonicima, kako bi se voda što manje raspršivala naokolo.
- Armature se serijski isporučuju s mjenjačem mlaza sa širokim vodenim mlazom. Za alternativni izgled mlaza priložen je aerator s okruglim laminarnim mlazom koji se lako može postaviti na licu mjesta (pogledaj stranicu 33).

Tehnički podatci

Armatura ima serijski ugrađen EcoSmart®

(limitator protoka)

Najveći dopušteni tlak: tlak 1 MPa

Preporučeni tlak: 0,1 – 0,5 MPa

Probni tlak: 1,6 MPa

(1 MPa = 10 bar = 147 PSI)

Temperatura vruće vode: tlak 80 °C

Preporučena temperatura vruće vode: 65 °C

Opis simbola



Nemojte koristiti silikon koji sadrži octenu kiselinu!



Mjere (pogledaj stranicu 34)



Dijagram protoka
(pogledaj stranicu 34)

① s limitatorom EcoSmart®

② bez limitatora EcoSmart®



Rezervni dijelovi (pogledaj stranicu 36)



Posebni pribor

ključ za montažu (58085000) Nije sadržano u isporuci!



Instalaterski kit Nije sadržano u isporuci!



Upotreba (pogledaj stranicu 38)



Čišćenje (pogledaj stranicu 37) i priložena brošura



Oznaka testiranja (pogledaj stranicu 38)



Sastavljanje pogledaj stranicu 31



! Güvenlik uyarıları

- ⚠ Montaj esnasında ezilme ve kesilme gibi yaralanmaları önlemek için eldiven kullanılmalıdır.
- ⚠ Duş sistemi yalnızca banyo, hijyen ve beden temizliği amaçları doğrultusunda kullanılabilir.
- ⚠ Sıcak ve soğuk su bağlantıları arasında büyük basınç farklılıkları varsa, bu basınç farklılıklarının dengelenmesi gerekir.

Montaj açıklamaları

- Batarya monte edilmeli, geçerli normlardan sonra akis testi yapılmalıdır.
- Sürekli akışlı su ısıtıcıları ile birlikte kullanımında problemler söz konusu ise veya akan su miktarının daha fazla olması isteniyorsa, perlatörün arka tarafındaki EcoSmart® (akış sınırlayıcısı) sökülüp çıkarılabilir.
- Hansgrohe bataryaları, akış basıncı en az 0,15 MPa olursa hidrolik ve termik kumandalı şofbenlerle bağlantılı olarak kullanılabilir.
- Bu armatür, yaşam kaynağı olan suyun doğal yönünün altını çizen bir havasız püskürtücü ile donatılmıştır. Havasız püskürtme ucunda hava karışımı olmayan bir püskürtme işlemi söz konusu olduğu için, su sıçramasını önlemek amacıyla ekstra derin lavabo kullanılmasını öneriyoruz.
- Bataryalar standart olarak geniş dalga su akışlı bir sprej modülle birlikte teslim edilir. Alternatif bir duş görünümü için, kurulum yerinde kolayca değiştirilebilen yuvarlak laminar su akışlı bir perlatör eklenmiştir (Bakınız sayfa 33).

Teknik bilgiler

Batarya EcoSmart® (akış sınırlayıcısı) ile birlikte seri olarak

İşletme basıncı:	azami 1 MPa
Tavsiye edilen işletme basıncı:	0,1 - 0,5 MPa
Kontrol basıncı:	1,6 MPa
(1 MPa = 10 bar = 147 PSI)	
Sıcak su sıcaklığı:	azami 80 °C
Tavsiye edilen su ısısı:	65 °C

Simge açıklaması



Asetik asit içeren silikon kullanmayın!



Ölçüleri (Bakınız sayfa 34)



Akış diyagramı
(Bakınız sayfa 34)

- ① EcoSmart® dahil
- ② EcoSmart® hariç



Yedek Parçalar (Bakınız sayfa 36)



Özel aksesuarlar

Montaj anahtar (58085000) Teslimat kapsamına dahil değildir



Montaj silikonu Teslimat kapsamına dahil değildir



Kullanımı (Bakınız sayfa 38)



Temizleme (Bakınız sayfa 37) ve birlikte verilen broşür





Kontrol işareti (Bakınız sayfa 38)





Instrucțiuni de siguranță

-  La montare utilizați mănuși pentru evitarea contuziunilor și tăierii mâinilor.
-  Sistemul de duș poate fi utilizat doar pentru spălarea, menținerea igienei și curățarea corpului.
-  Diferențele de presiune mari între alimentarea cu apă rece și apă caldă trebuie echilibrate.

Instrucțiuni de montare

- Bateria trebuie montată, clătită și verificată conform normelor în vigoare.
- Dacă apar probleme cu boilerul instant sau dacă doriți un debit de apă mai mare, puteți să demontați unitatea EcoSmart® (limitatorul de debit), care se află în spatele suflătorului de aer.
- Bateriile Hansgrohe pot fi utilizate cu boiler instant cu comandă termică sau hidraulică dacă presiunea apei de alimentare este de min. 0,15 MPa.
- Armătura este dotată cu un jet cu efect de ploaie, care subliniază caracteristicile naturale ale elementului de viață, apa. Deoarece la jetul de apă cu efect de ploaie nu se adaugă aer, se recomandă utilizarea unei chiuvete extra adânci pentru evitarea stropirii.
- Bateriile sunt livrate în serie cu un capăt de duș cu duză pentru jet lat. Pentru obținerea unui jet diferit, pachetul conține un pulverizator de aer cu un jet laminar rotund, care poate fi montat ușor (vezi pag. 33).

Date tehnice

Bateria este dotată în serie cu EcoSmart®

(limitator de debit)

Presiune de funcționare:	max. 1 MPa
Presiune de funcționare recomandată:	0,1 – 0,5 MPa
Presiune de verificare:	1,6 MPa
(1 MPa = 10 bar = 147 PSI)	
Temperatura apei calde:	max. 80 °C
Temperatura recomandată a apei calde:	65 °C

Descrierea simbolurilor



Nu utilizați silicon cu conținut de acid acetic!



Dimensiuni (vezi pag. 34)



Diagrama de debit
(vezi pag. 34)

- ① cu EcoSmart®
- ② fără EcoSmart®



Piese de schimb (vezi pag. 36)



Accesorii opționale

Cheie pentru montare (58085000) nu este inclus în setul livrat



Chit de instalare nu este inclus în setul livrat

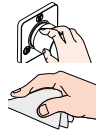

Utilizare (vezi pag. 38)

Curățare (vezi pag. 37) și broșura alăturată



Certificat de testare (vezi pag. 38)



Montare vezi pag. 31



⚠ Υποδείξεις ασφαλείας

- ⚠ Για να αποφύγετε τραυματισμούς κατά τη συναρμολόγηση πρέπει να φοράτε γάντια.
- ⚠ Το προϊόν επιτρέπεται να χρησιμοποιείται μόνο σαν μέσο λουτρού, υγιεινής και καθαρισμού του σώματος.
- ⚠ Οι διαφορές της πίεσης μεταξύ της σύνδεσης κρύου και ζεστού νερού θα πρέπει να αντισταθμίζονται.

Οδηγίες συναρμολόγησης

- Η μπαταρία πρέπει να τοποθετηθεί, να πλυθεί και να ελεγχθεί με βάση τους ισχύοντες κανόνες υδραυλικής τέχνης
- Εάν παρουσιαστεί πρόβλημα με τον ταχυθερμοσίφωνα ή όταν απαιτείται περισσότερο νερό, μπορεί να απομακρυνθεί ο EcoSmart® (μειωτής ροής), ο οποίος βρίσκεται πίσω από το φίλτρο του ρουζουνιού.
- Οι βάνες Hansgrohe μπορούν να συνδυαστούν με ταχυθερμοσίφωνα υδραυλικού και θερμικού ελέγχου, όταν η πίεση ροής αριθμεί τουλάχιστον 0,15 MPa.
- Η μπαταρία αυτή εκτοξεύει το νερό με τη μορφή καταρράκτη, τονίζοντας έτσι τη ζωντάνια του φυσικού στοιχείου του νερού. Η δέση νερού που εκτοξεύεται σαν καταρράκτης δεν περιέχει αέρα και για να μην πιτσιλά συνιστούμε τη χρήση νιπτήρων με μεγάλο βάθος.
- Οι βάνες παραδίδονται τυποποιημένες με μία διάταξη καναλιών καταιονισμού με ευρεία ακτίνα εκροής. Για ένα εναλλακτικό αποτέλεσμα, επισυνάπτεται ένα φίλτρο με στρογγυλή, γραμμική ροή το οποίο μπορεί να ανανεωθεί επιτόπου (βλ. σελίδα 33).

Τεχνικά Χαρακτηριστικά

Μπαταρία μόνιμα εξοπλισμένη με EcoSmart®

(μειωτής ροής)

Λειτουργία πίεσης: έως 1 MPa

Συνιστώμενη λειτουργία πίεσης: 0,1 - 0,5 MPa

Πίεση ελέγχου: 1,6 MPa

(1 MPa = 10 bar = 147 PSI)

Θερμοκρασία ζεστού νερού: έως 80 °C

Συνιστώμενη θερμοκρασία ζεστού νερού: 65 °C

Περιγραφή συμβόλων



Μην χρησιμοποιείτε σιλικόνη που περιέχει οξικό οξύ!



Διαστάσεις (βλ. σελίδα 34)



Διάγραμμα ροής
(βλ. σελίδα 34)

① με EcoSmart®

② χωρίς EcoSmart®



Ανταλλακτικά (βλ. σελίδα 36)



Ειδικά αξεσουάρ

Κλειδί συναρμολόγησης (58085000) δεν περιλαμβάνεται στον παραδοτέο εξοπλισμό



Κιτ εγκατάστασης δεν περιλαμβάνεται στον παραδοτέο εξοπλισμό



Χειρισμός (βλ. σελίδα 38)



Καθαρισμός (βλ. σελίδα 37) και συνημμένο φυλλάδιο





Σήμα ελέγχου (βλ. σελίδα 38)





Varnostna opozorila

-  Pri montaži je treba nositi rokavice, da se preprečijo poškodbe zaradi zmečkanja ali urezov.
-  Ta izdelek se sme uporabljati le z namenom umivanja, vzdrževanja higiene in telesne nege.
-  Velike razlike v tlaku med priključkom za mrzlo in priključkom za toplo vodo je potrebno izravnati.

Instructions pour le montage

- Armatura je potrebno montirati, splakniti in testirati v skladu z veljavnimi predpisi.
- Če imate probleme s pretočnim grelnikom, ali če želite večji pretok vode, lahko odstranite EcoSmart® (omejevalnik pretoka), ki se nahaja za perlatorjem.
- Armature Hansgrohe lahko uporabljate v povezavi s hidravlično in termično uravnavanimi pretočnimi grelniki, če je pretočni tlak najmanj 0,15 MPa.
- Ta armatura je opremljena s poplavnim curkom, ki poudarja naravno stran življenjskega elementa vode. Ker gre pri poplavnem curku za curek brez primešavanja zraka, priporočamo, da se izognete škropitvi tako, da uporabite posebej globok umivalnik.
- Armature se serijsko dobavljajo z usmerjevalnikom curka s širokim curkom. Za alternativno obliko curka je priložen perlator z okroglim laminarnim curkom, ki se po potrebi z lahkoto namesti (glejte stran 33).

Tehnični podatki

Armatura je serijsko opremljena z EcoSmart®
(omejevalnikom pretoka)

Delovni tlak:	maks. 1 MPa
Priporočeni delovni tlak:	0,1 – 0,5 MPa
Preskusni tlak:	1,6 MPa
(1 MPa = 10 bar = 147 PSI)	
Temperatura tople vode:	maks. 80 °C
Priporočena temperatura tople vode:	65 °C

Opis simbola



Ne smete uporabiti silikona, ki vsebuje očetno kislino!



Mere (glejte stran 34)



Diagram pretoka
(glejte stran 34)

- ① z omejevalnikom pretoka EcoSmart®
- ② brez omejevalnika pretoka EcoSmart®



Rezervni deli (glejte stran 36)



Poseben pribor

Montažni ključ (58085000) Ni vključeno



Komplet za montažo Ni vključeno



Upravljanje (glejte stran 38)



Čiščenje (glejte stran 37) in priložena brošura



Preskusni znak (glejte stran 38)



Montaža Glejte stran 31.



⚠ Ohutusjuhised

- ⚠ Kandke paigaldamisel muljumis- ja löikevigastuste vältimiseks kindaid.
- ⚠ Toodet tohib kasutada ainult pesemis-, hügieeni- ja kehapihustamiseks.
- ⚠ Kui külma ja kuuma vee ühenduste surve on väga erinev, tuleb need tasakaalustada.

Paigaldamisjuhised

- Seadmestiku paigaldamine, läbipesu ja kontrollimine peab toimuma vastavalt kehtivatele normidele.
- Kui esineb probleeme läbivooluhooleiga või kui soovitakse, et vee läbivool oleks suurem, tuleks sõela taga asuv EcoSmart® (veehulgapiiraja) eemaldada.
- Hansgrohe segisteid võib kasutada koos hüdrauliliselt ja termiliselt juhitavate boileritega, kui vee surve on vähemalt 0,15 MPa.
- See segisti on varustatud survejoaga, mis rõhutab vee kui põhielemendi loomuliku külge. Kuna survejoa puhul on tegemist joaga, millele ei ole õhku juurde segatud, soovitame veepritsmete vältimiseks kasutada eriti sügavat valamut.
- See segistiseeria on toodetud järgnevatele pihustamis mudelitele - pihusti koos veeseinaga. Alternatiivseks pihustuseks on komplektis ka monopihusti, mis on kergelt vahetatav! (vt lk 33).

Tehnilised andmed

Segistisari on toodetud koos EcoSmart®
(veehulgapiirajaga)

Töörõhk	maks. 1 MPa
Soovitav tööõhk:	0,1 – 0,5 MPa
Kontrollsurve:	1,6 MPa
(1 MPa = 10 baari = 147 PSI)	
Kuuma vee temperatuur:	maks. 80 °C
Soovitav kuuma vee temperatuur:	65 °C

Sümbolite kirjeldus



Ärge kasutage äädikhapet sisaldavat silikooni!



Mõõtude (vt lk 34)



Läbivooludiagramm
(vt lk 34)

- ① EcoSmart® olemas
- ② EcoSmart® puudub



Varuosad (vt lk 36)



Spetsiaalne lisavarustus

Montaaživõti (58085000) ei sisaldu komplektis



Paigalduskomplekt ei sisaldu komplektis

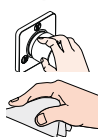

Kasutamine (vt lk 38)

Puhastamine (vt lk 37) ja kaasasolev brošüür



Kontrollsertifikaat (vt lk 38)





Drošības norādes

- ⚠ Montāžas laikā, lai izvairītos no spaspiedumiem un iegriezumiem, nepieciešams nēsāt cimdus.
- ⚠ Šo produktu drīkst izmantot tikai, lai mazgātos, higiēnai un ķermeņa tīrīšanai.
- ⚠ Jāizlīdzina spiediena atšķirības starp aukstā un karstā ūdens pievadiem.

Norādījumi montāžai

- Jaucējkrāns jāmontē, jāskalo un jāpārbauda atbilstoši spēkā esošajām normām.
- Ja rodas problēmas ar caurteces sildītāju vai ja ūdens plūsma nav pietiekami spēcīga, EcoSmart® (caurteces ierobežotāju), kas atrodas aiz aeratora, drīkst noņemt.
- Hansgrohe jaucējkrānus var izmantot kombinācijā ar hidrauliski un termiski vadāmiem caurteces sildītājiem, ja plūsmas spiediens ir vismaz 0,15 MPa.
- Šai armatūrai ir iespējama kaskādes strūkļa, kas pasvīturo ūdens kā dzīvības elementa dabisko pusi. Tā kā kaskādes strūklā nav gaisa, lai izvairītos no ūdens šļakatām, iesakām izmantot īpaši dziļas izlietnes.
- Jaucējkrānus sērijveidā piegādā ar strūklas veidotāju ar platu strūkļu. Lai iegūtu alternatīvu strūklas formu, ir pievienots aerators ar apaļu lamināro strūkļu, kuru viegli iespējams pārveidot uz vietas (skat. 33. lpp.).

Tehniskie dati

Jaucējkrāns tiek ražots kopā ar EcoSmart®

(caurteces ierobežotāju)

Darba spiediens:	maks. 1 MPa
Ieteicamais darba spiediens:	0,1 – 0,5 MPa
Pārbaudes spiediens:	1,6 MPa
(1 MPa = 10 bar = 147 PSI)	
Karstā ūdens temperatūra:	maks. 80 °C
Ieteicamā karstā ūdens temperatūra:	65 °C

Simbolu nozīme



Neizmantojiet silikonu, kas satur etiķskābi!



Izmērus (skat. 34. lpp.)



Caurplūdes diagramma
(skat. 34. lpp.)

- ① ar EcoSmart®
- ② bez EcoSmart®



Rezerves daļas (skat. 36. lpp.)



Speciāli aksesuāri

Montāžas atslēga (58085000) komplektā netiek piegādāta



Instalācijas piederumi komplektā netiek piegādāti

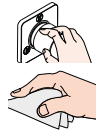

Lietošana (skat. 38. lpp.)

Tīrīšana (skat. 37. lpp.) un klāt pievienotais buklets



Pārbaudes zīme (skat. 38. lpp.)





Sigurnosne napomene

- ⚠ Prilikom montaže se radi sprečavanja prignječenja i posekotina moraju nositi rukavice.
- ⚠ Proizvod sme da se koristi samo za kupanje, tuširanje i ličnu higijenu.
- ⚠ Velika razlika u pritisku između vruće i hladne vode mora biti izbalansirana.

Instrukcije za montažu

- Armatura mora biti postavljena, isprana i testirana prema važećim normama.
- Ukoliko se pojave problemi sa protočnim bojlerom ili se želi veći protok vode, onda EcoSmart® (ograničavač protoka vode), koji je smešten iza aeratora, može da se ukloni.
- Hansgrohe armature se mogu koristiti u kombinaciji s hidraulički i termički kontrolisanim protočnim bojlerima ukoliko pritisak iznosi najmanje 0,15 MPa.
- Ova armatura je opremljena mlazom za zapljuskivanje, koji naglašava prirodnu stranu vode kao životnog elementa. Budući da se kod mlaza za zapljuskivanje radi o mlazu kome se ne dodaju mehurići vode, preporučujemo ga za primenu u posebno dubokim umivaonicima, kako bi voda što manje prskala okolo.
- Armature se serijski isporučuju s uobličavačem mlaza sa širokim vodenim mlazom. Za alternativni izgled mlaza priložen je aerator s okruglim laminarnim mlazom koji se lako može postaviti na licu mesta (vidi stranu 33).

Tehnički podaci

Ove armature imaju serijski ugrađen

EcoSmart® (ograničavač protoka vode)

Radni pritisak: maks. 1 MPa

Preporučeni radni pritisak: 0,1 – 0,5 MPa

Probni pritisak: 1,6 MPa

(1 MPa = 10 bar = 147 PSI)

Temperatura vruće vode: maks. 80 °C

Preporučena temperatura vruće vode: 65 °C

Opis simbola



Nemojte koristiti silikon koji sadrži sirćetnu kiselinu!



Mere (vidi stranu 34)



Dijagram protoka
(vidi stranu 34)

- ① sa ograničavačem EcoSmart®
- ② bez ograničavača EcoSmart®



Rezervni delovi (vidi stranu 36)



Poseban pribor

ključ za montažu (58085000) Nije sadržano u isporuci



Instalaterski komplet Nije sadržano u isporuci



Rukovanje (vidi stranu 38)



Čišćenje (vidi stranu 37) i priložena brošura





Ispitni znak (vidi stranu 38)





Sikkerhetshenvisninger

-  Bruk hansker under montasjen for å unngå klem- og kuttskader.
-  Dusjsystemet skal kun brukes for bade-, hygiene- og kroppshygiene.
-  Store trykkdifferanser mellom kaldt- og varmtvannstilkoblinger skal utlignes.

Montagehenvisninger

- Armaturen skal monteres, spyles og sjekkes iht. gyldige standarder.
- Ved problemer med gjennomstrømningsovnen, eller når man ønsker en større vanngjennomstrømning, kan EcoSmart® (gjennomstrømningsbegrenser) fjernes. Den sitter bak luftdysene.
- Armaturer fra Hansgrohe kan brukes sammen med hydraulisk og termisk strypte gjennomstrømningsovner når gjennomstrømningstrykket er på minst 0,15 MPa.
- Denne armaturen er utstyrt med en skyllstråle som fremhever den naturlige siden av livselementet vann. Ved skyllstråle dreier det seg om en stråle uten tilsetning av luft. For å forhindre alt for mye sprut anbefaler vi derfor å bruke en ekstra dyp vask.
- Standardmessig leveres armaturer med en stråleformer som gir en bred stråle. For et alternativt strålebilde leveres også en luftsprudler med en rund laminarstråle. Den kan lett monteres på stedet (se side 33).

Tekniske data

Armatur er standardmessig utstyrt med EcoSmart® (gjennomstrømningsbegrenser)

Driftstrykk	maks. 1 MPa
Anbefalt driftstrykk:	0,1 – 0,5 MPa
Prøvetrykk	1,6 MPa
(1 MPa = 10 bar = 147 PSI)	
Varmtvannstemperatur	maks. 80 °C
Anbefalt temperatur for varmt vann	65 °C

Symbolbeskrivelse



Ikke bruk silikon som inneholder eddiksyre!



Mål (se side 34)



Gjennomstrømningsdiagram
(se side 34)

- ① med EcoSmart®
- ② uten EcoSmart®



Serviceleder (se side 36)



Ekstratilbehør

Montasjenøkkel (58085000) ikke med i leveransen



Installasjonskitt ikke med i leveransen

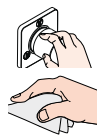

Betjening (se side 38)



Rengjøring (se side 37) og vedlagt brosjyre

Prøvermerke (se side 38)



Montasje se side 31



Указания за безопасност

- ⚠ При монтажа трябва да се носят ръкавици, за да се избегнат наранявания поради притискане или порязване.
- ⚠ Позволено е използването на продукта само за къпане, хигиена и цели на почистване на тялото.
- ⚠ Големите разлики в налягането между изводите за студената и топлата вода трябва да се изравняват.

Указания за монтаж

- Арматурата трябва да се монтира, промие и провери в съответствие с валидните норми.
- При проблеми с проточния нагревател или когато желаете по-голяма пропускателна способност на водата, може да отстраните EcoSmart® (ограничителя на протичане), който се намира зад аератора.
- Арматурите на Hansgrohe могат да се използват във връзка с хидравлично и термично управляеми проточни нагреватели, ако хидравличното налягане е минимум 0,15 МПа.
- Тази арматура е снабдена с преливаща струя, която подчертава естествената страна на живия елемент вода. Тъй като при преливащата струя става въпрос за струя без прибавяне на въздух, за да избегнете пръскането на вода Ви препоръчваме да използвате много дълбок умивалник.
- Арматурите се доставят серийно с приспособление за оформяне на струята с широка преливаща струя. За да се получи алтернативна струя е добавен аератор с кръгла ламинарна струя, който може да се пренастрои лесно на място (вижте стр. 33).

Технически данни

Арматурата е оборудвана серийно с EcoSmart® (ограничител на протичане)

Работно налягане:	макс. 1 МПа
Препоръчително работно налягане:	0,1 – 0,5 МПа
Контролно налягане:	1,6 МПа
(1 МПа = 10 bar = 147 PSI)	
Температура на горещата вода:	макс. 80 °C
Препоръчителна температура на горещата вода:	65 °C

Описание на символите



Не използвайте силикон, съдържащ оцетна киселина!



Размери (вижте стр. 34)



Диаграма на потока (вижте стр. 34)

- ① с EcoSmart®
- ② без EcoSmart®



Сервизни части (вижте стр. 36)



Специални принадлежности

Монтажен ключ (58085000) не се съдържа в обема на доставка



Инсталационен кит не се съдържа в обема на доставка

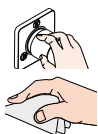

Обслужване (вижте стр. 38)

Почистване (вижте стр. 37) и приложена брошура



Контролен знак (вижте стр. 38)



Монтаж вижте стр. 31



Udhëzime sigurie

- △ Për të evituar lëndimet e pickimeve ose të prerjeve gjatë procesit të montimit duhet që të vishni doreza.
- △ Produkti duhet të përdoret vetëm qëllimet e banjave, të higjienës dhe të larjes së trupit.
- △ Ndryshimet e mëdha të presionit mes lidhjeve të ujit të ftohtë dhe atij të ngrohtë duhen ekuilibruar.

Udhëzime për montimin

- Armatura duhet montuar, shpërlarë dhe kontrolluar në bazë të normave të vlefshme.
- Nëse lindin probleme me ngrohësin e ujit ose nëse dëshironi të keni më shumë qarkullim uji, atëherë EcoSmart® (kufizuesi i qarkullimit të ujit), i cili ndodhet pas ajrosësit, mund të çmontohet.
- Armaturat e Hansgrohe mund të përdoren në kombinim me ngrohës elektrikë të ujit të drejtuar në mënyrë hidraulike ose termike nëse presioni i rrjedhjes është minimumi 0,15 MPa.
- Kjo armaturë është e pajisur me një curri, i cili e nënvizon anën natyrore të elementit jetësor ujë. Meqenëse ky curril nuk përzihet me ajër, atëherë ne ju këshillojmë që për evitimin e spërkatjeve të padëshiruar të përdorni lavamanë shumë të thellë.
- Armaturat dërgohen sipas prodhimit serik me një formues currilash me curril të rrëkeshëm të gjerë. Për alternativa të tjera të currilat kemi bashkëngjitur një perlator me një curril të rumbullakët petëzoz, të cilit mund të zëvendësohet fare lehtë në vend (shih faqen 33).

Të dhëna teknike

Rubineti është i pajisur si standard me EcoSmart® (Kufizues qarkullimi)

Presioni gjatë punës	maks. 1 MPa
Presioni i rekomanduar:	0,1 – 0,5 MPa
Presioni për provë:	1,6 MPa
(1 MPa = 10 bar = 147 PSI)	
Temperatura e ujit të ngrohtë	maks. 80 °C
Temperatura e rekomanduar e ujit të ngrohtë:	65 °C

Përshkrimi i simbolit



Mos përdorni silikon që në përbërje ka acid acetik.



Përmasat (shih faqen 34)



Diagrami i qarkullimit (shih faqen 34)

- ① me EcoSmart®
- ② pa EcoSmart®



Pjesë ndërrimi (shih faqen 36)



Pajisje të posaçme

Çelësi i montimit (58085000) nuk përfshihet në vëllimin e furnizimit



Stuko për instalim nuk përfshihet në vëllimin e furnizimit



Përdorimi (shih faqen 38)



Pastrimi (shih faqen 37) dhe broshura bashkëngjitur



Shenja e kontrollit (shih faqen 38)





وصف الرمز

هام! لا تستخدم السليكون الذي يحتوي على أمحاض!

أبعاد (راجع صفحة 34)

رسم للصراف

(راجع صفحة 34)

① EcoSmart® بـ

② بدون EcoSmart®

قطع الغيار (راجع صفحة 36)

ملحقات خاصة

مفتاح التركيب (58085000) غير مدرج مع المحتويات المسلمة

طقم تركيب غير مدرج مع المحتويات المسلمة

التشغيل (راجع صفحة 38)

التنظيف (راجع صفحة 37) والكتيب المرفق

شهادة اختبار (راجع صفحة 38)



تنبيهات الأمان



- ⚠ يجب ارتداء قفازات لليد أثناء التركيب لتجنب حدوث أضرار الإنحشار أو الجروح.
- ⚠ لا يجب استخدام نظام الدش إلا في أغراض الاستحمام والأغراض الصحية وأغراض تنظيف الجسم.
- ⚠ يجب أن يكون تيار الماء الساخن والماء البارد متعادلين في الضغط.

تعليمات التركيب

- يجب تركيب الوصلة واستخدامها واختبارها وفقاً للمعايير المعمول بها.
- إذا تسبب سخان الماء الجاري في أية مشكلات أو في حالة الرغبة في وجود تدفق أكثر للماء، يجب فك EcoSmart® (محدد تدفق المياه) الموجود خلف تجهيزة التهوية.
- يمكن استخدام خلاطات هانزجروهي مع سخانات تدفق الماء ذات التحكم الهيدروليكي و الحراري، مع ضغط تدفق لا يقل عن 0,15 ميجاباسكال.
- إن خلاط الماء هذا مجهز بخاصية تدفق الماء، وهو ما يظهر الماء كعنصر أساسي للحياة في شكله الطبيعي الرائع. ولأن الماء يخرج هنا بشكل تدفقي وبدون أي خلط للهواء معه، فإننا ننصح بتركيب أحواض ماء عميقة نوعاً ما لتجنب حدوث تناثر الماء أثناء الاستخدام.
- تم إنتاج سلسلة الخلاطات بنمط الرشاش التالي – مع مكون رش ومسقط ماء. للحصول على رشاش بديل، تم إرفاق مهوي برشاش أحادي، يمكن تغييره بسهولة في موقع التركيب. (راجع صفحة 33)

المواصفات الفنية

يتم بشكل قياسي إنتاج الخلاط هذا مع EcoSmart® (محدد تدفق المياه)

الحد الأقصى 1 ميجاباسكال
ضغط التشغيل: 0,5 – 0,1 ميجاباسكال
ضغط الاختبار: 1,6 ميجاباسكال

(1 ميجاباسكال = 10 بار = 147 PSI)

الحد الأقصى 80°C
درجة حرارة الماء الساخن:
الحد الأقصى 65°C
درجة الحرارة الموصى بها للماء الساخن:



التركيب راجع صفحة 31

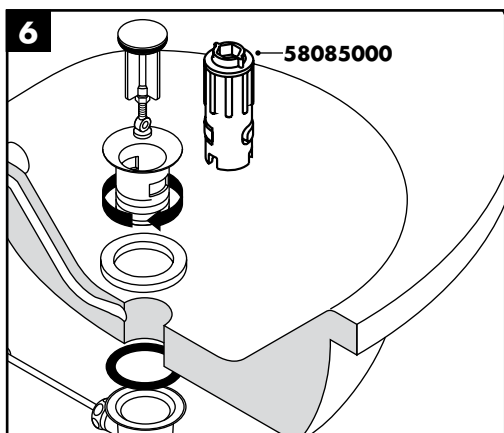
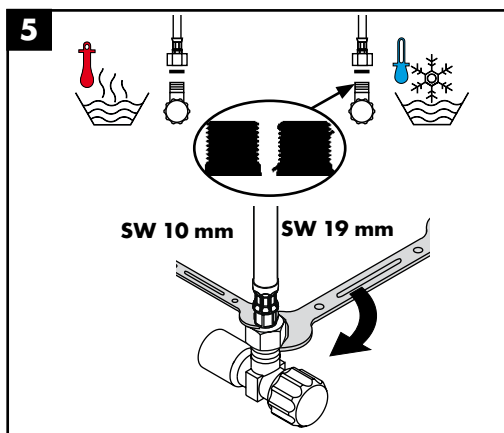
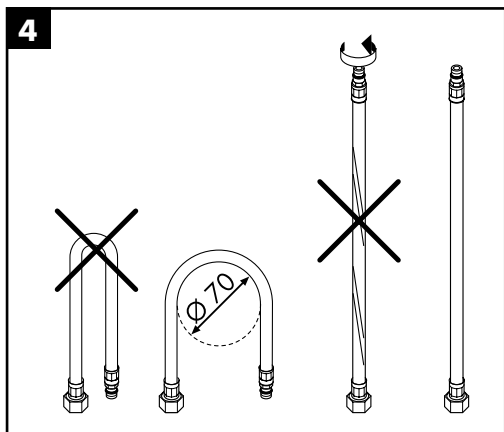
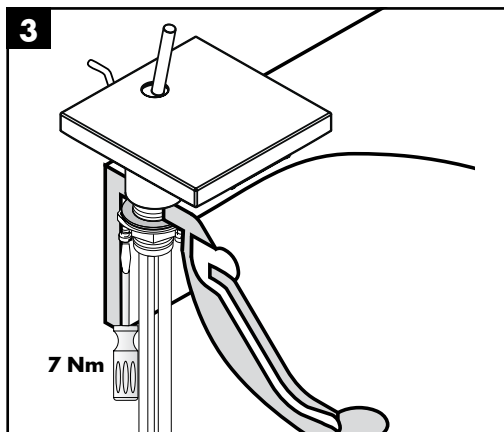
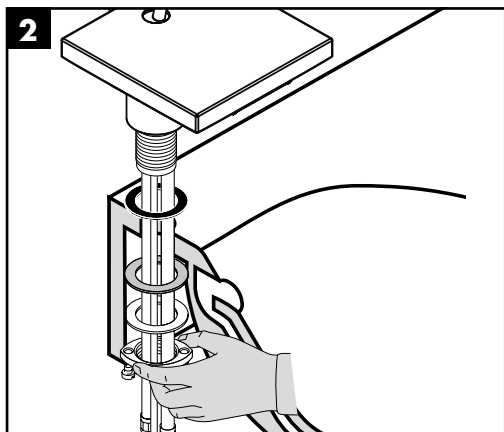
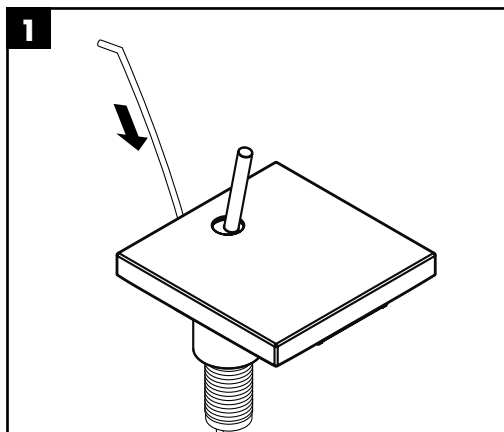

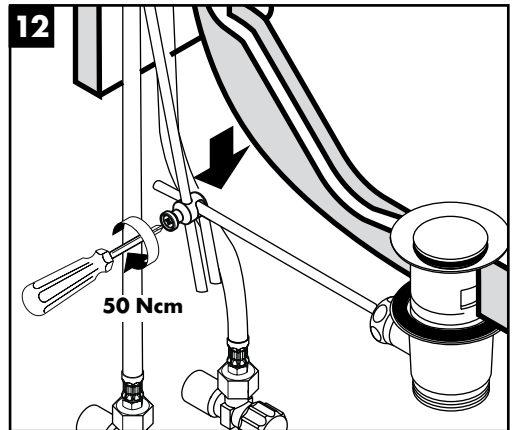
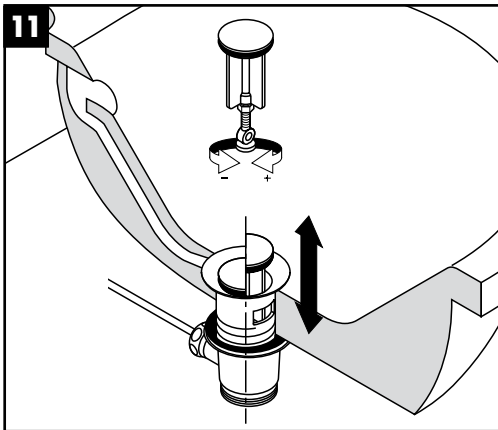
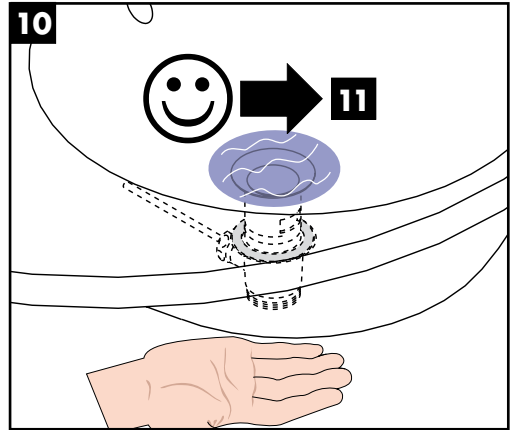
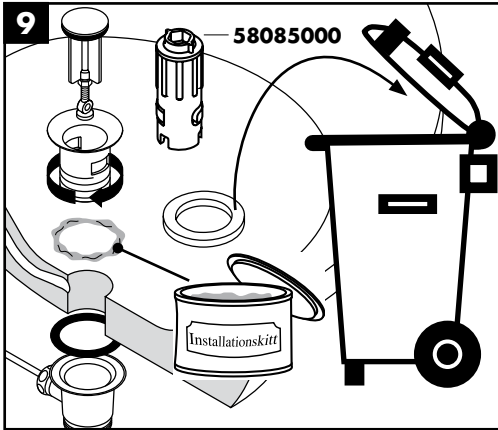
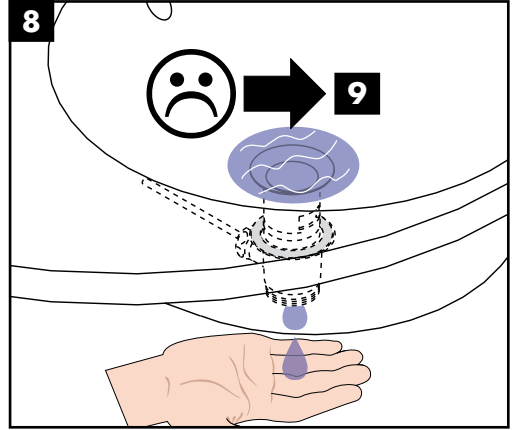
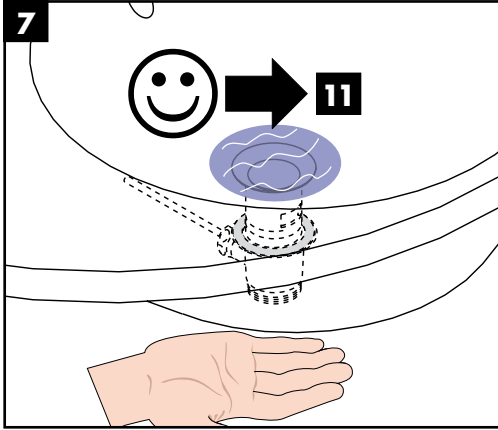

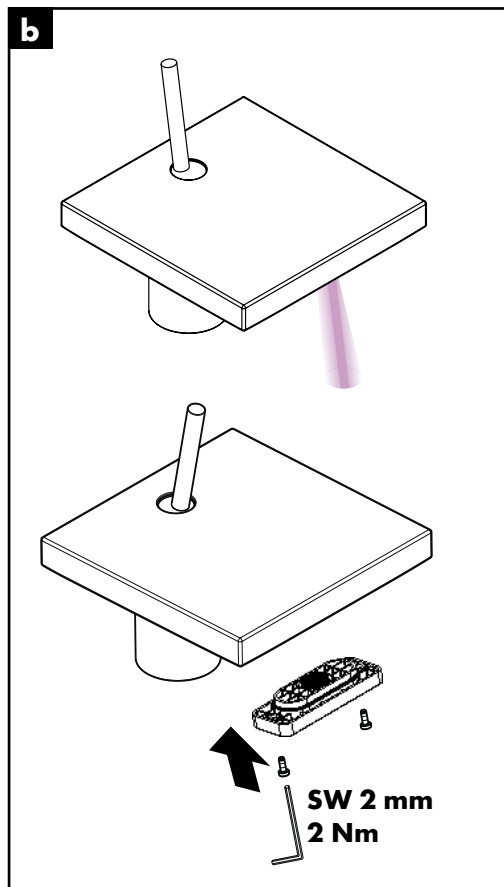
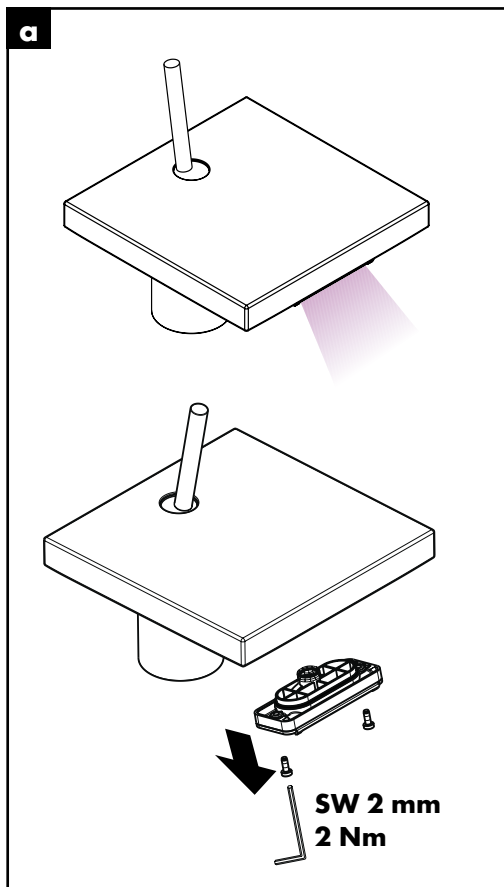



Starck X 10070000

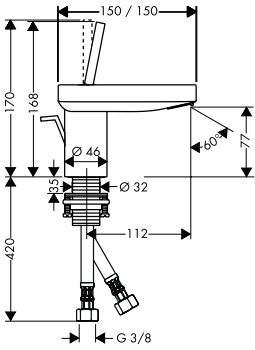

Starck X 10071000

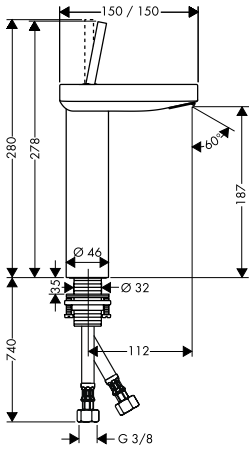

Starck X 10072000

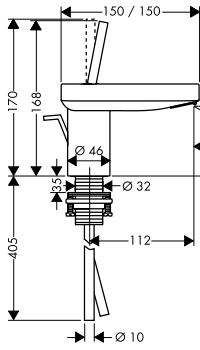

Starck X 10077000

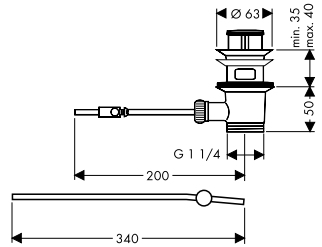
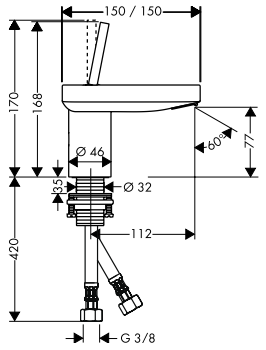

Starck X
10070000 / 10071000 / 10072000 / 10077000

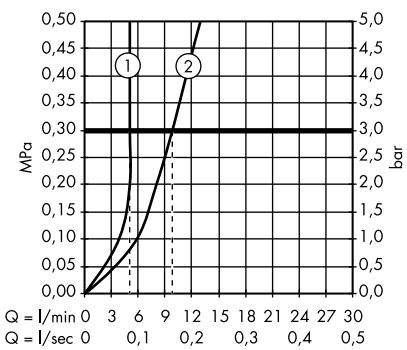

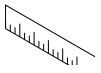

Starck X 10080000

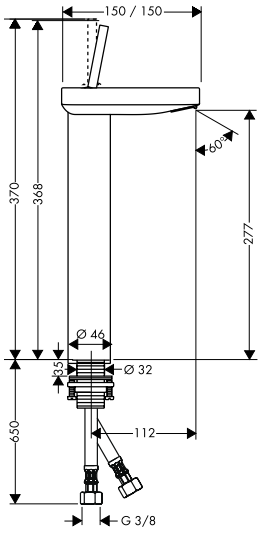

Starck X 10084000

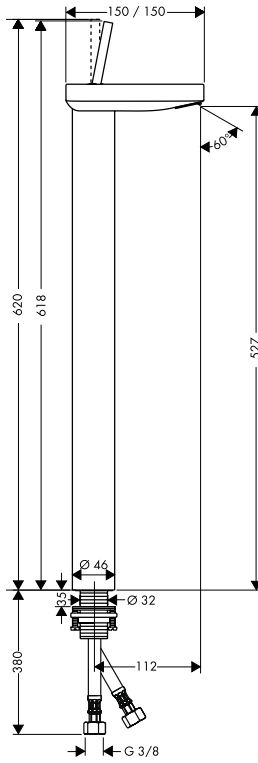

Starck X 10205000

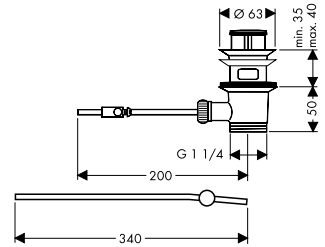
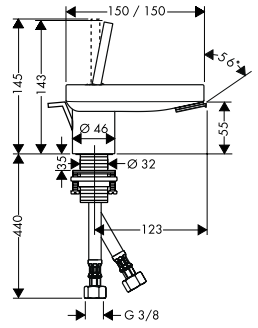

Starck X

10080000 / 10084000 / 10205000

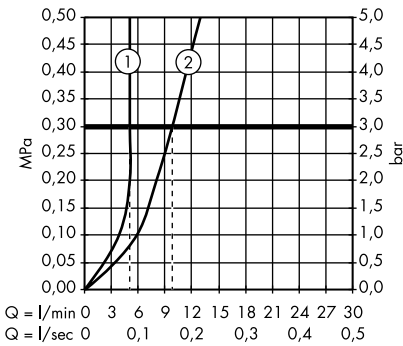

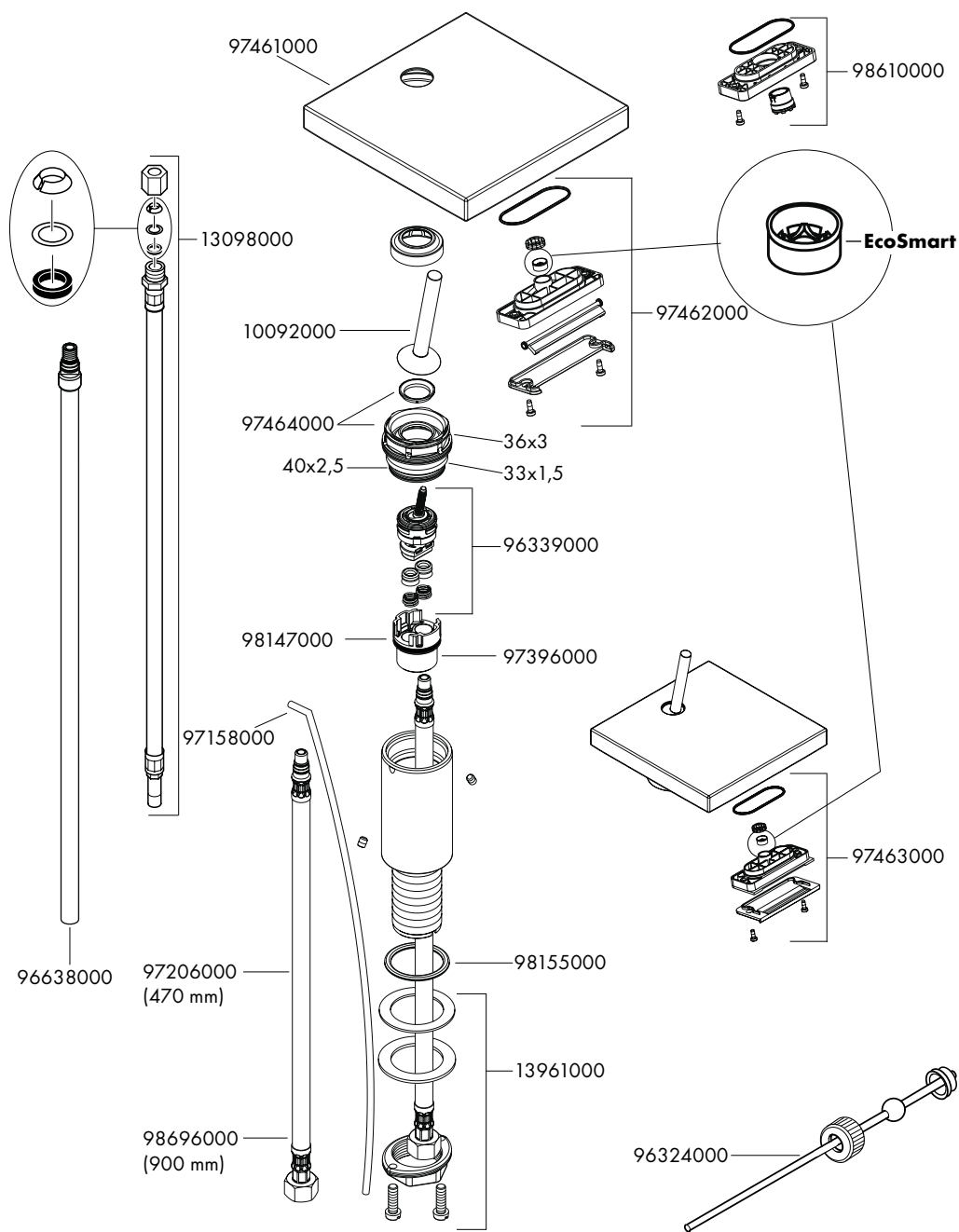

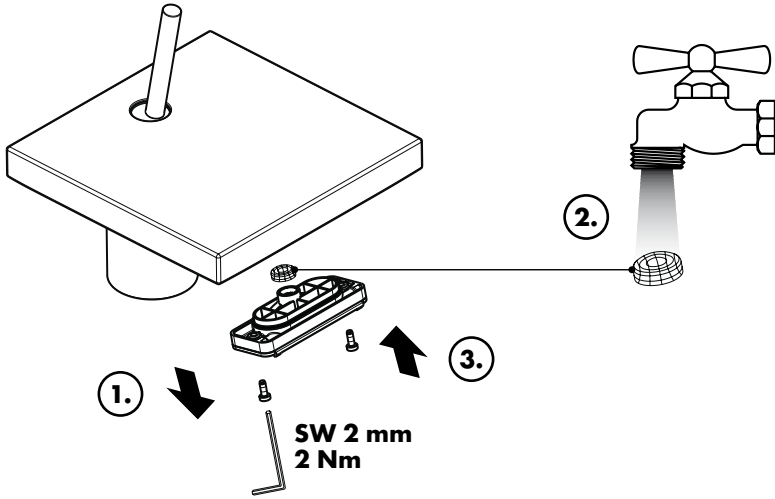

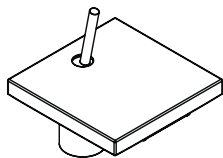

öffnen / ouvert / open / aperto / abierto / open / åbne /
 abrir / otworzyć / otevřít / otvorit / 开 / открьт / nyitás /
 avaaminen / öppna / atidaryti / Отваранье / açmak /
 deschide / ανοικτό / odpreti / avage / atvērt /
 otvoriti / åpne / отварање / hare / فتح

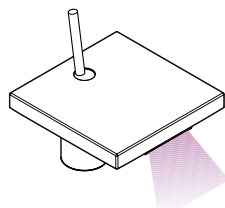

schließen / fermé / close / chiudere / cerrar / sluiten /
 lukke / fechar / zamknąć / zavřít / uzavrieti / 关 /
 закрыть / bezárás / sulkeminen / stänga / uždaryti /
 Zatvaranje / karatmak / închide / κλειστό /
 zapreti / sulgege / aizvērt / zatvori / lukke / затваряне /
 mbylle / إغلاق

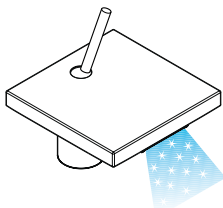

kalt / froid / cold / freddo / frío / koud / koldt / fria /
 zimna / studená / studená / 冷 / холодная / hideg /
 kylmä / kallt / šaltas / Hladno / soğuk / reze / κρύο /
 mrzlo / külm / auksts / hladno / kaldt / студено / i ftohtë /
 بارد

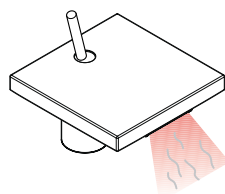

warm / chaud / hot / caldo / caliente / warm / varmt /
 quente / ciepła / teplá / teplá / 热 / горячая / meleg /
 lämmin / varmt / karštas / Vruća voda / sıcak / cald /
 ζεστό / toplo / kuum / karsts / topla / varm / топло /
 i ngrohtë / ساخن



	P-IX	DVGW	SVGW	ACS	WRAS	KIWA	ETA
10070000	P-IX 18080/IO		X	X	X	X	
10071000	P-IX 18080/IO		X	X	X	X	X
10072000	P-IX 18080/IO			X			X
10077000	P-IX 18080/IO		X	X		X	X
10080000	P-IX 18080/IO		X	X	X	X	X
10084000	P-IX 18080/IO		X	X	X	X	X
10205000	P-IX 18080/IO		X	X		X	

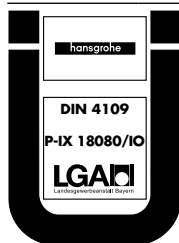

hansgrohe

Hansgrohe - Postfach 1145 · D-77761 Schiltach · Telefon +49 (0) 78 36/51-1282 · Telefax +49 (0) 7836/511440
E-Mail: info@hansgrohe.com · Internet: www.hansgrohe.com

09/2010
9.0531704