

Montageanleitung

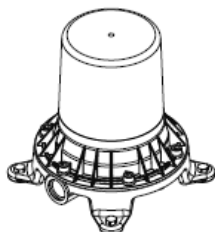

Starck
10452180

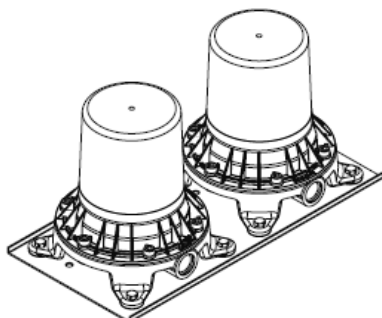

Montreux
16549180

AXOR[®]

hansgrohe

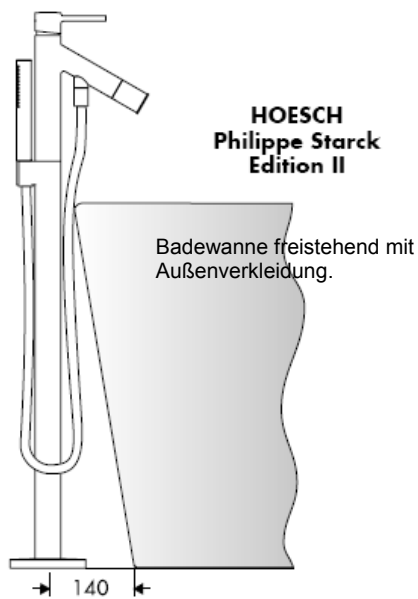
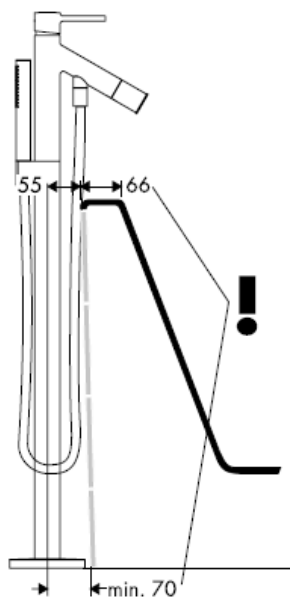

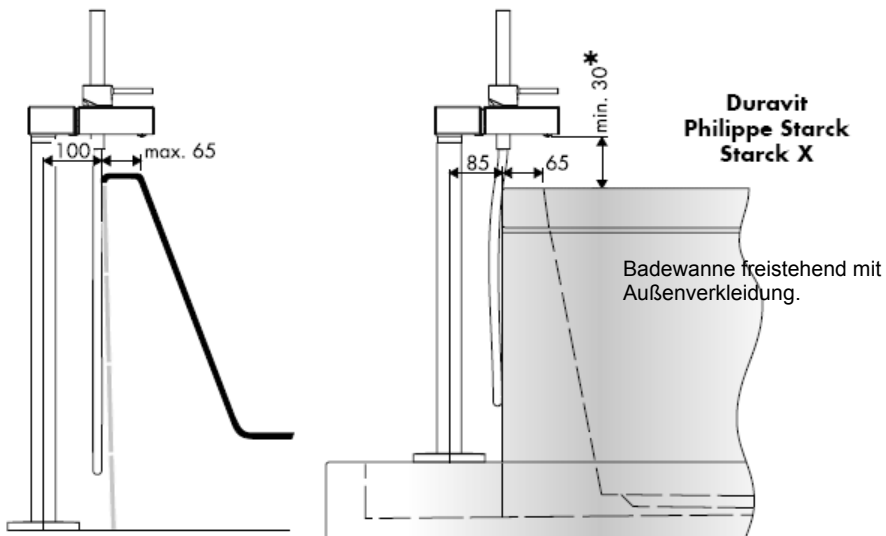

* < 30 min = Verlängerung 60 mm (Artikelnummer 97686000)



Massaud 18450000

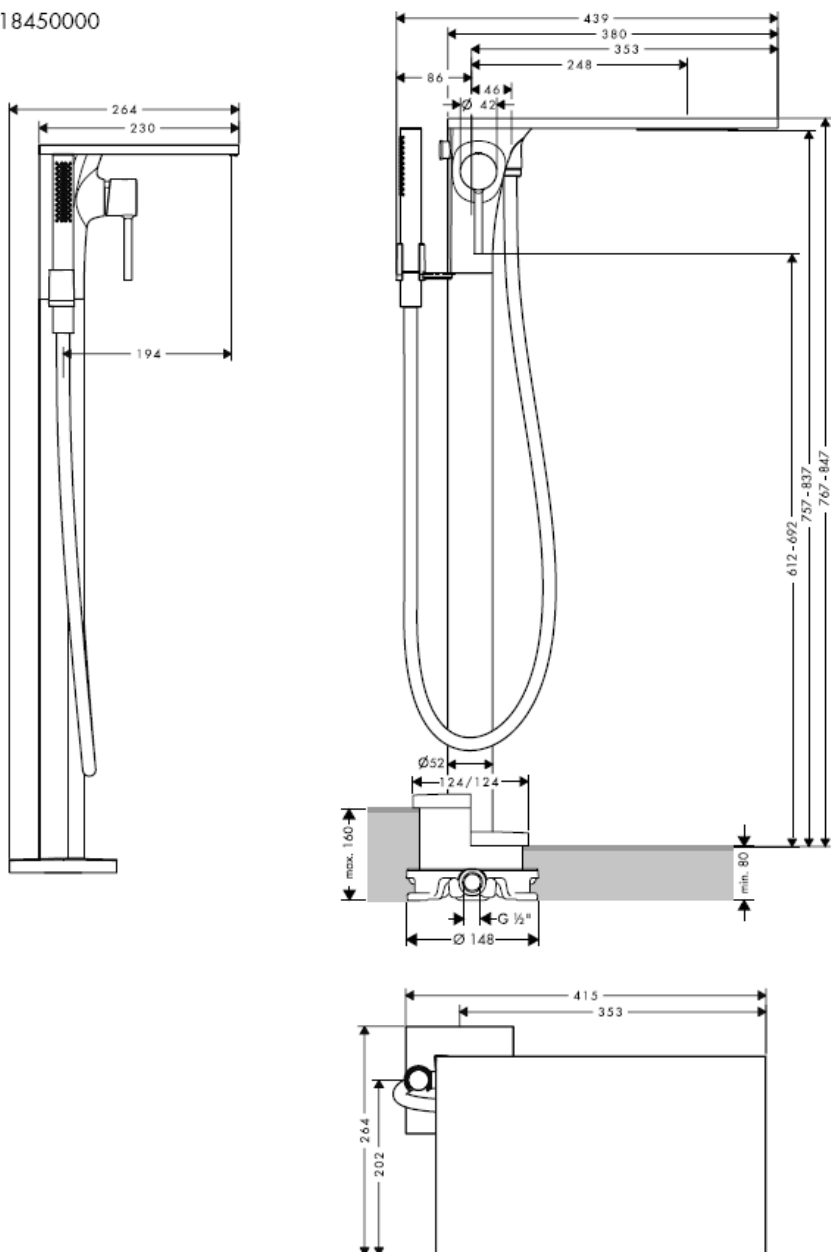

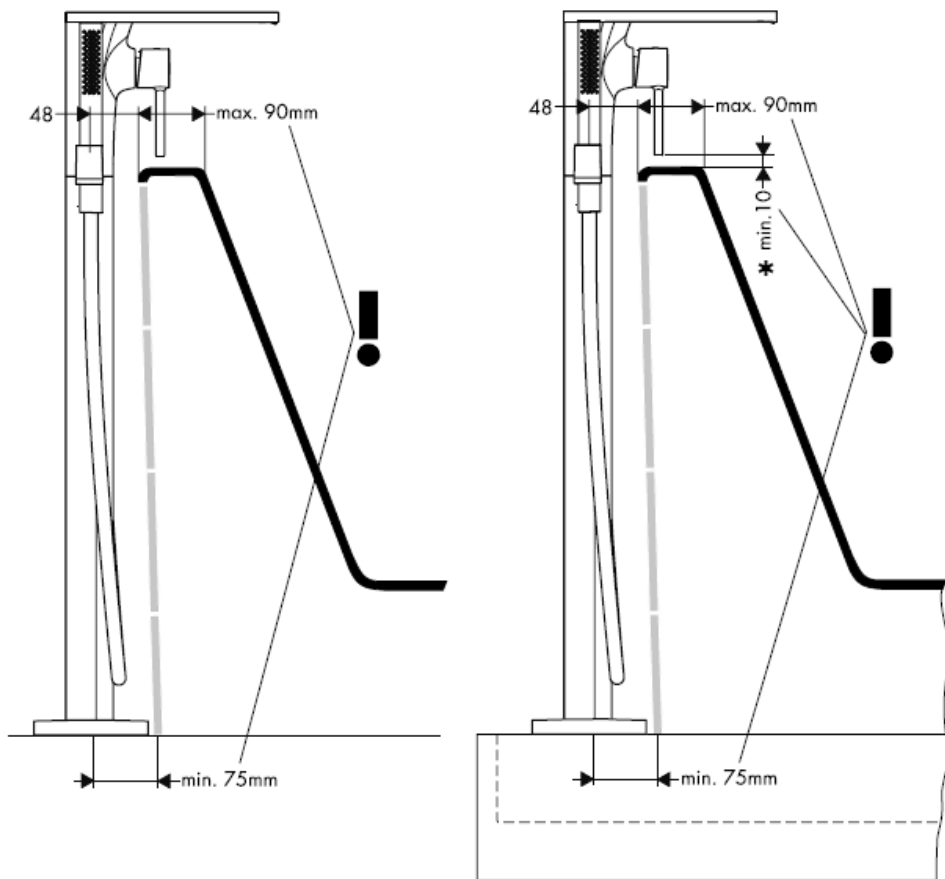

* < 10 min = Verlängerung 60 mm (Artikelnummer 97686000)

Citterio 39451000

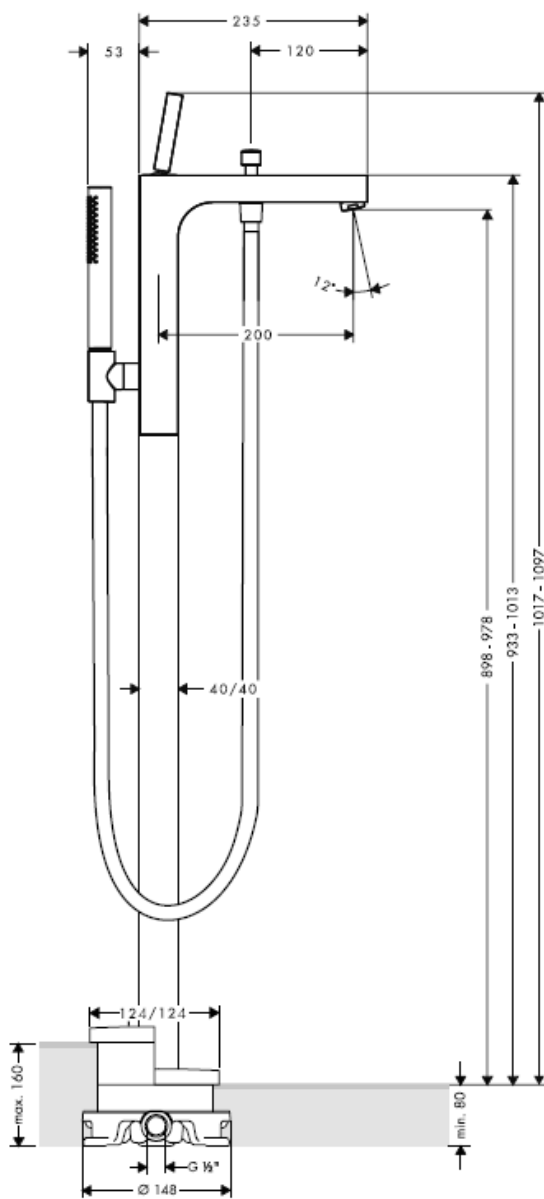

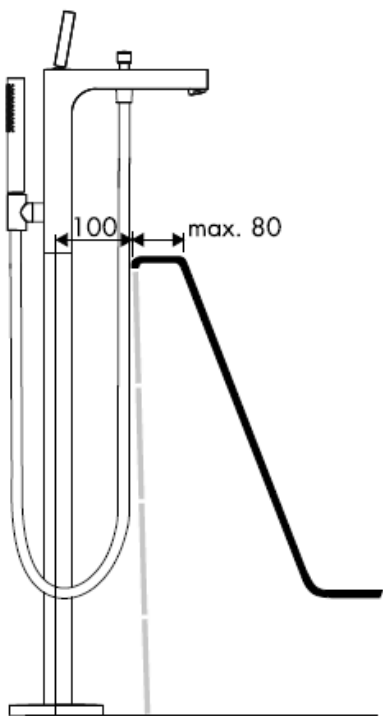

Achtung! Die Armatur muss nach den gültigen Normen montiert, gespült und geprüft werden!

Starck 10452180

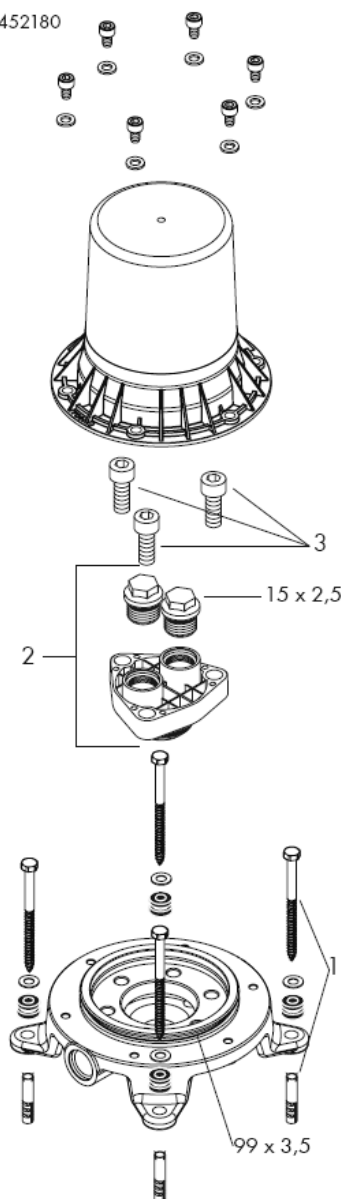

Montreux 16549180

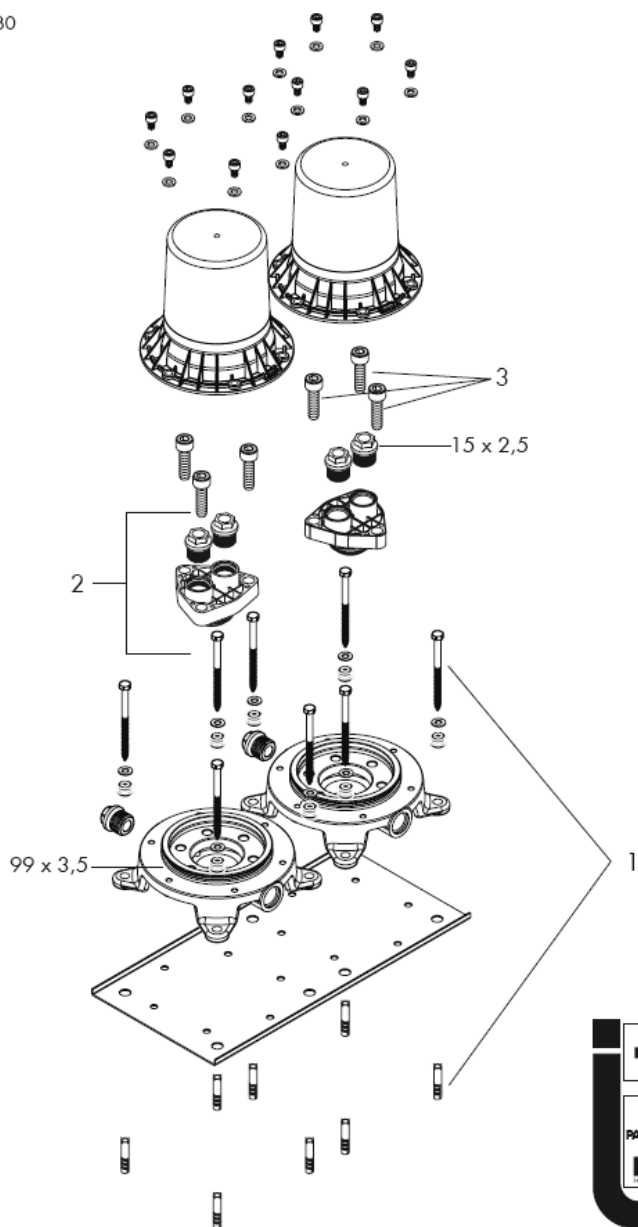

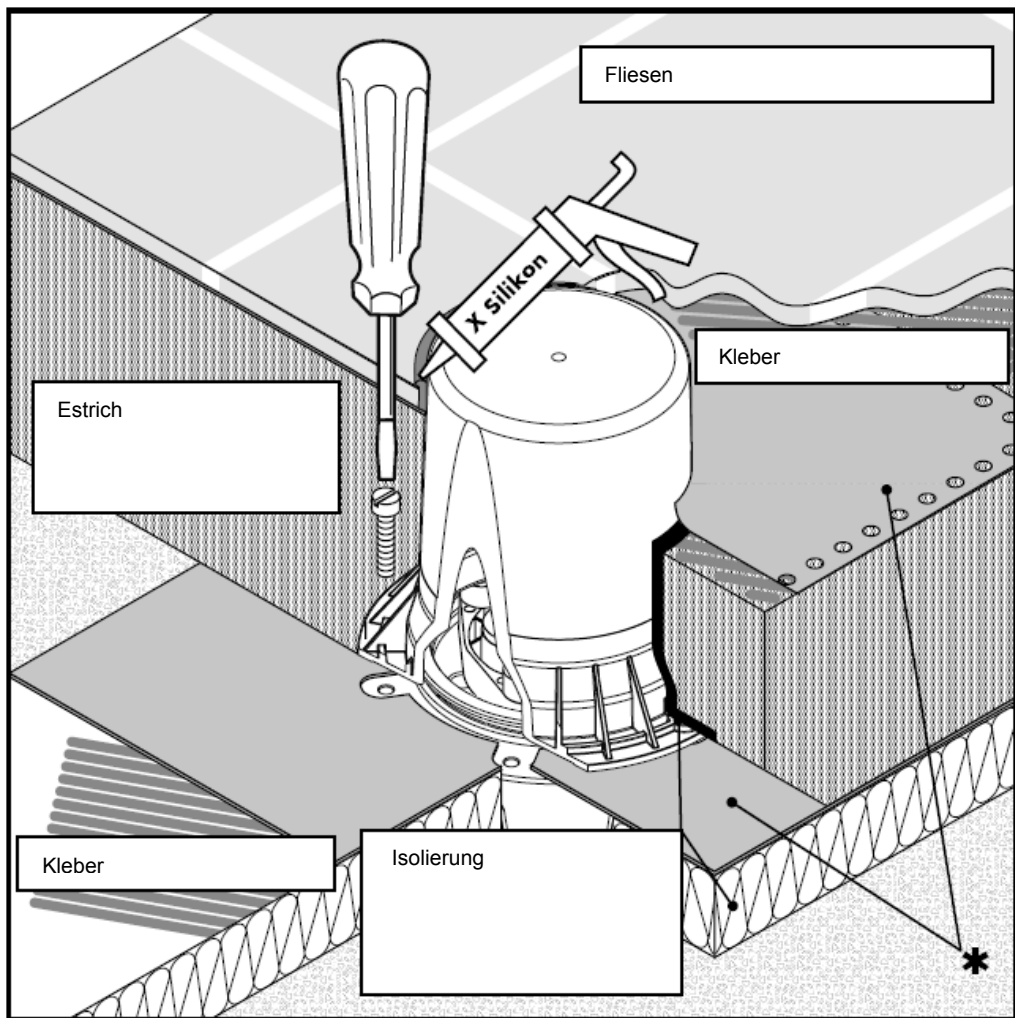

* optional erhältliche Dichtmanschette

X Silikon (essigsäurefrei!)

Montage

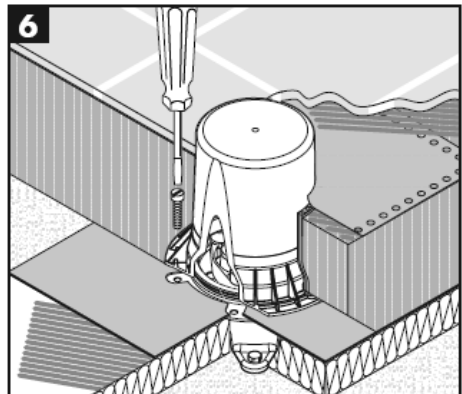
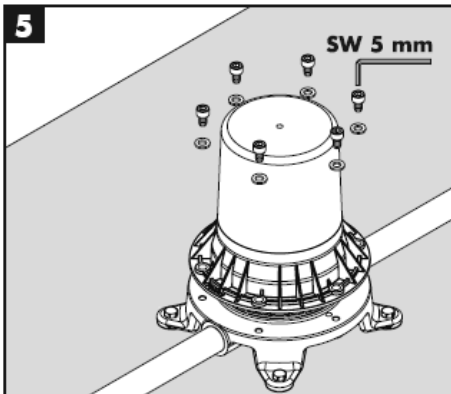
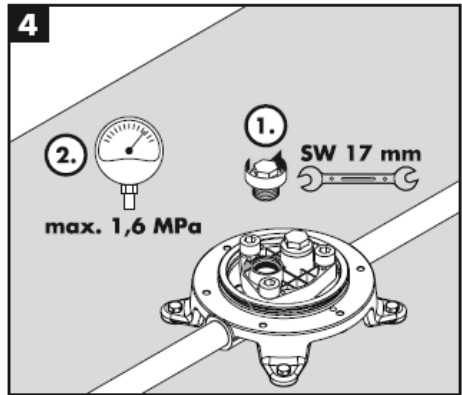
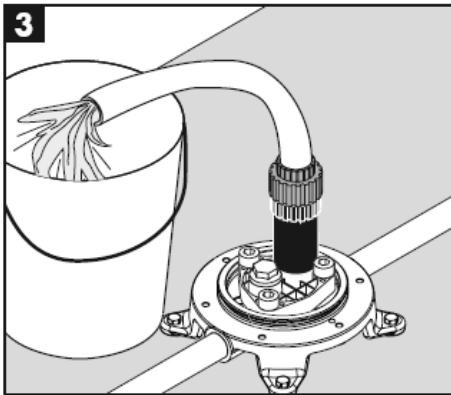
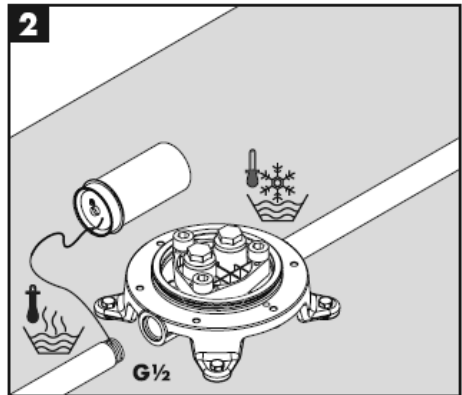
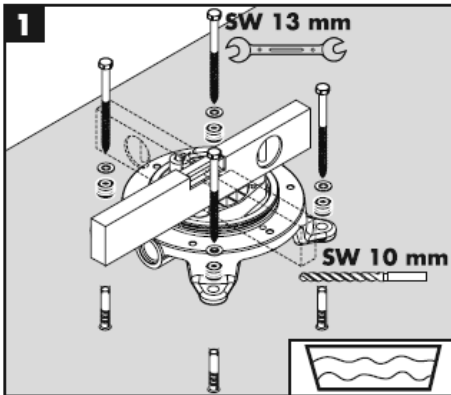

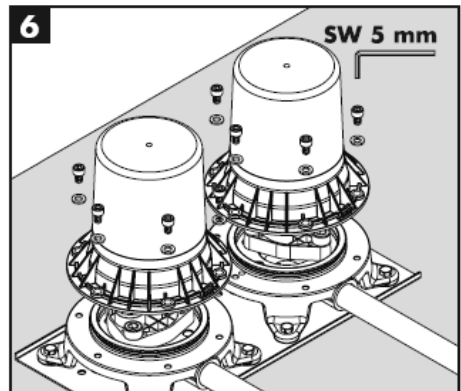
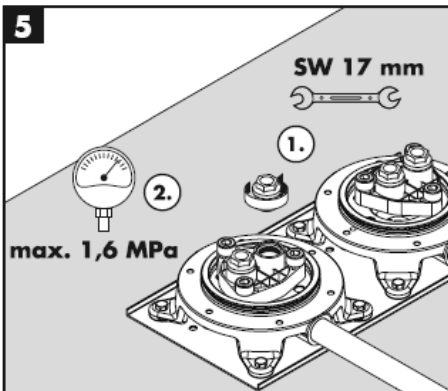
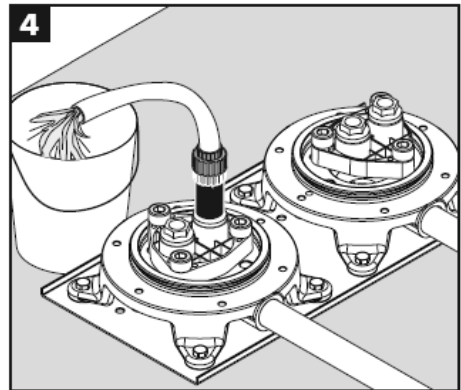
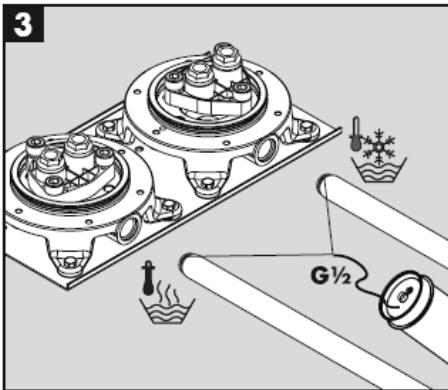
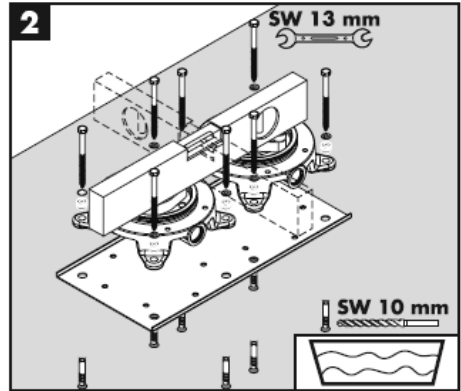
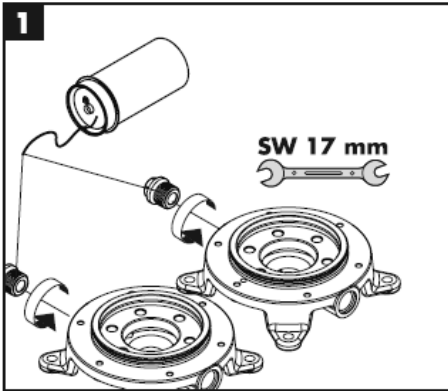

Montage

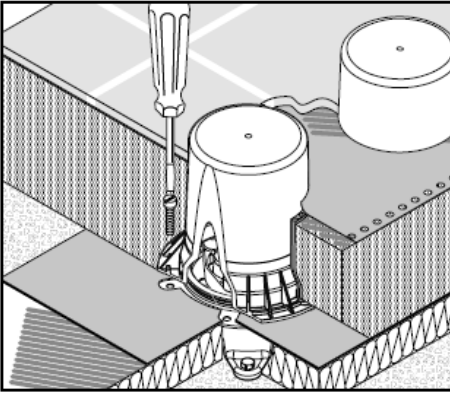

Deutsch

Technische Daten

Betriebsdruck:	max. 1 MPa
Empfohlener Betriebsdruck:	0,1 – 0,5 MPa
Prüfdruck:	1,6 MPa
(1 MPa = 10 bar = 147 PSI)	
Heißwassertemperatur:	max. 80° C
Empfohlene Heißwassertemperatur:	65° C

Service Teile siehe Seite 10 – 11

Befestigungssatz	96260000
Dichtungsset	96459000
Zylinderschraube M 10 x 35	97670000

Sonderzubehör

* Dichtmanschette	96441000
(nicht im Lieferumfang enthalten)	

Prüfzeichen

	DVGW	P-IX	SVGW	ACS	NF	WRAS	KIWA
10452180				x		X	
16549180		PA-IX 18729/ICB					

hansgrohe

Instructions de montage

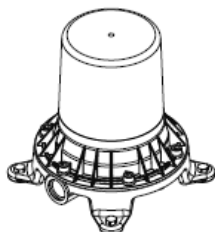

Starck
10452180

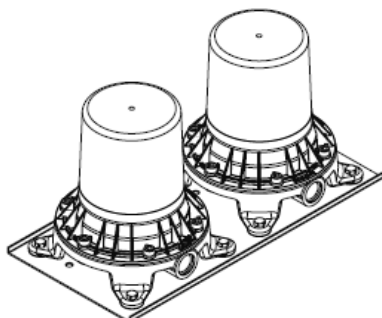

Montreux
16549180

AXOR[®]

hansgrohe

Starck 10458XXX

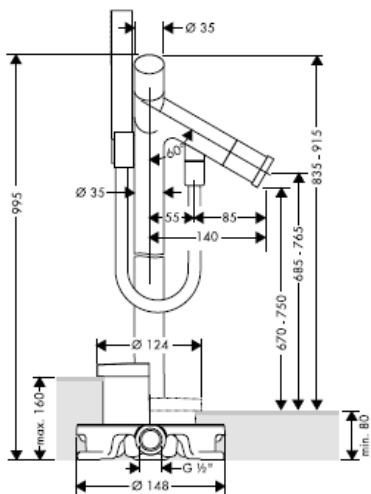

Starck 10060XXX

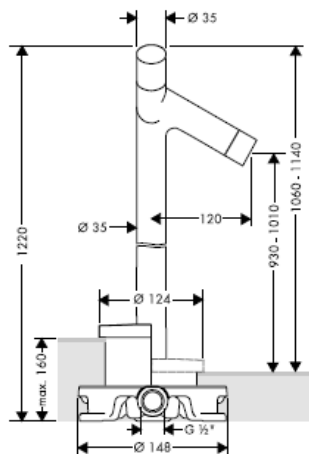

Starck 10456XXX

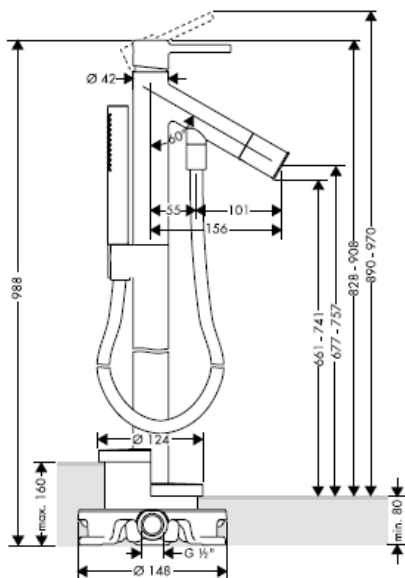

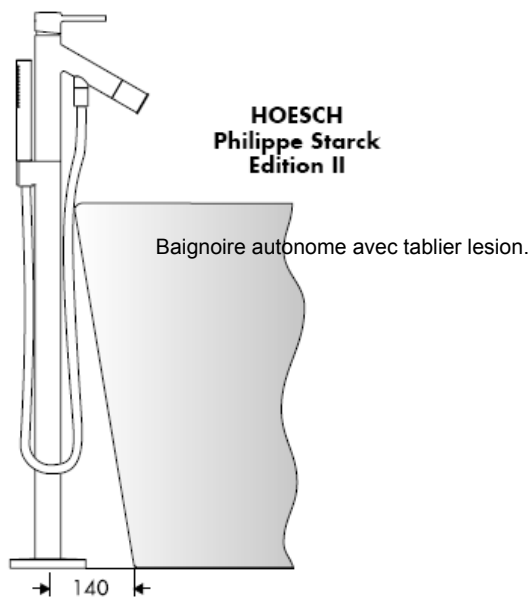
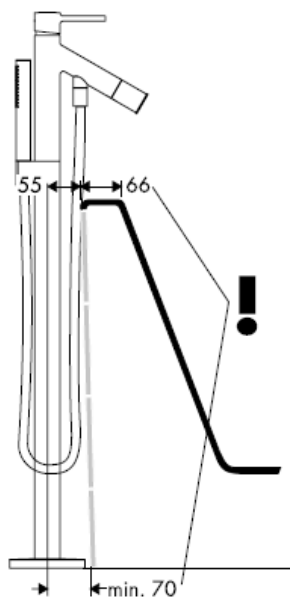
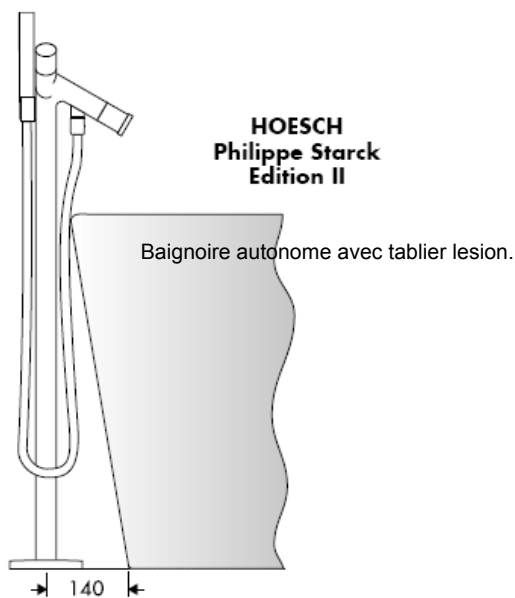

Starck X 10406000

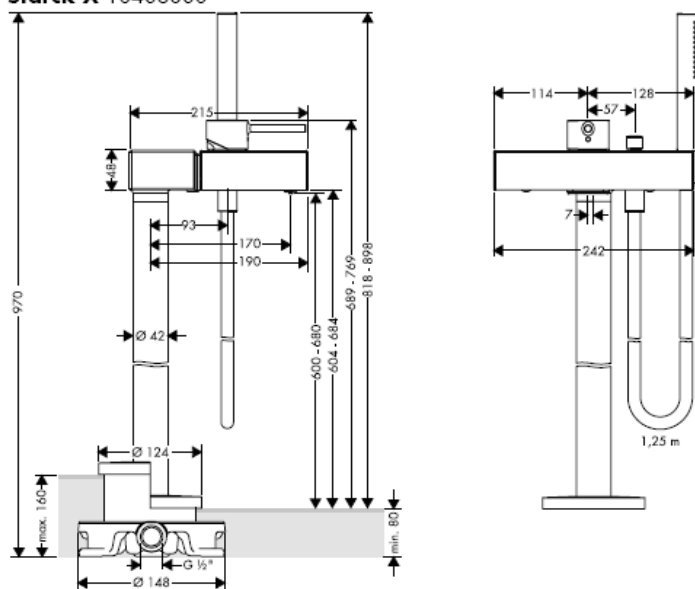

Montreux 16547XXX

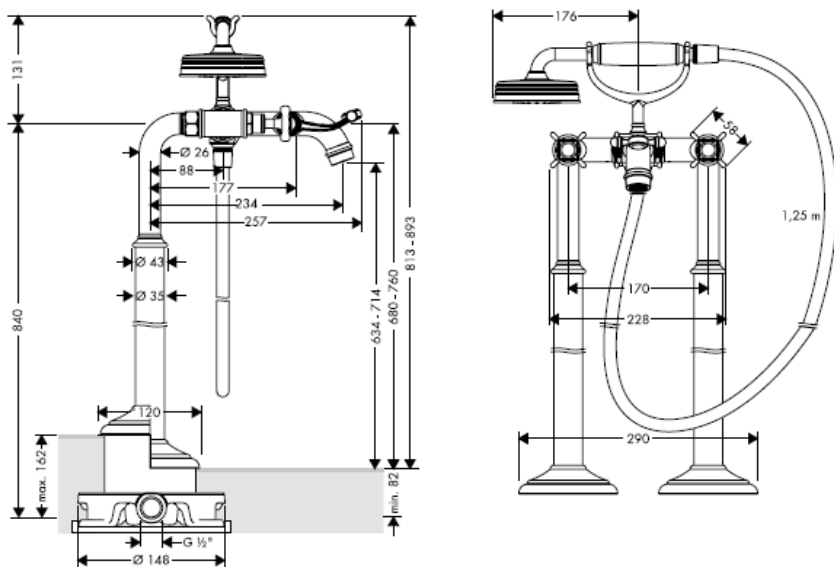

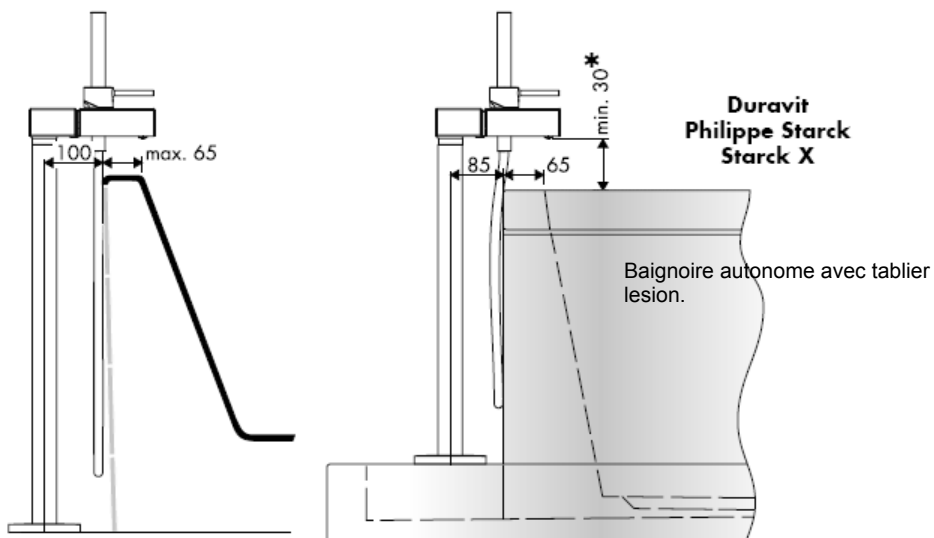

* < 30 min = jeu de rallonge 60 mm (référence 97686000)

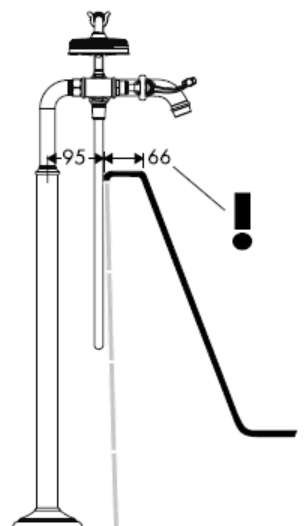

Massaud 18450000

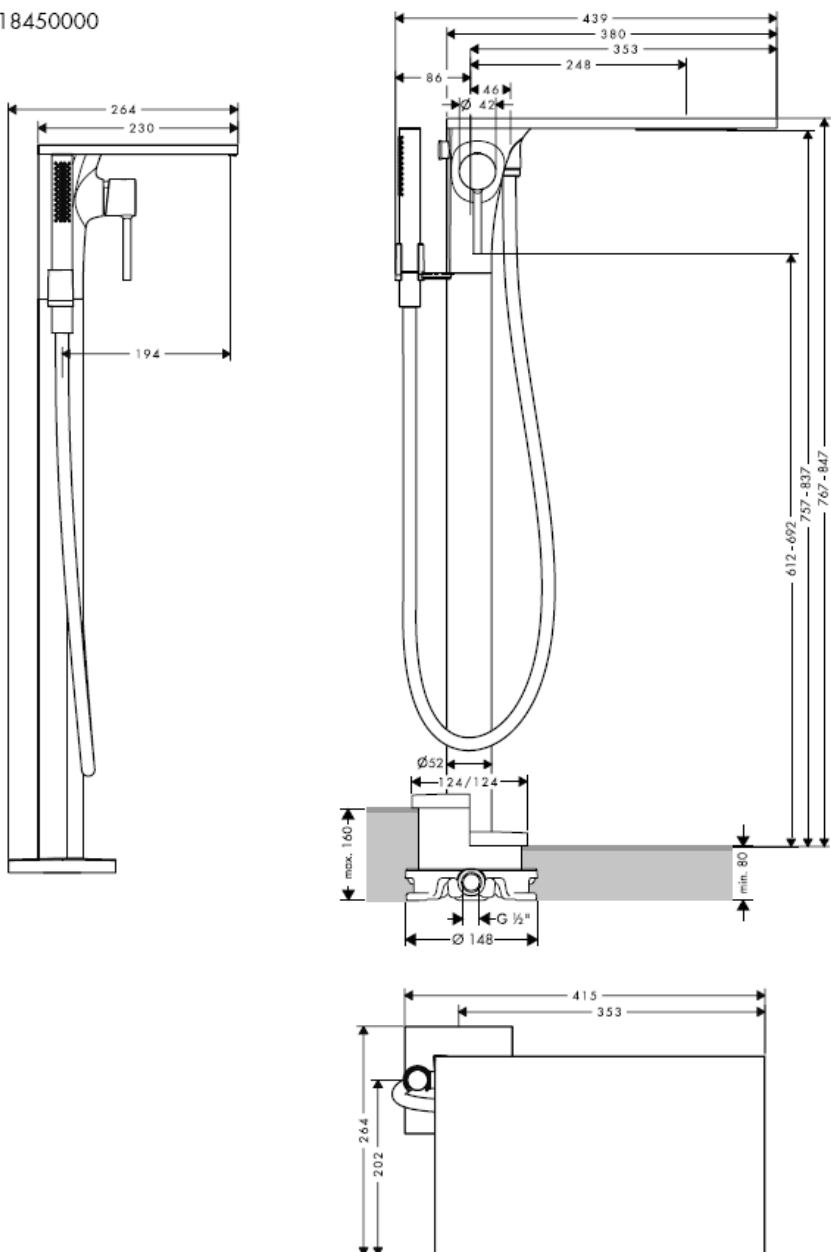

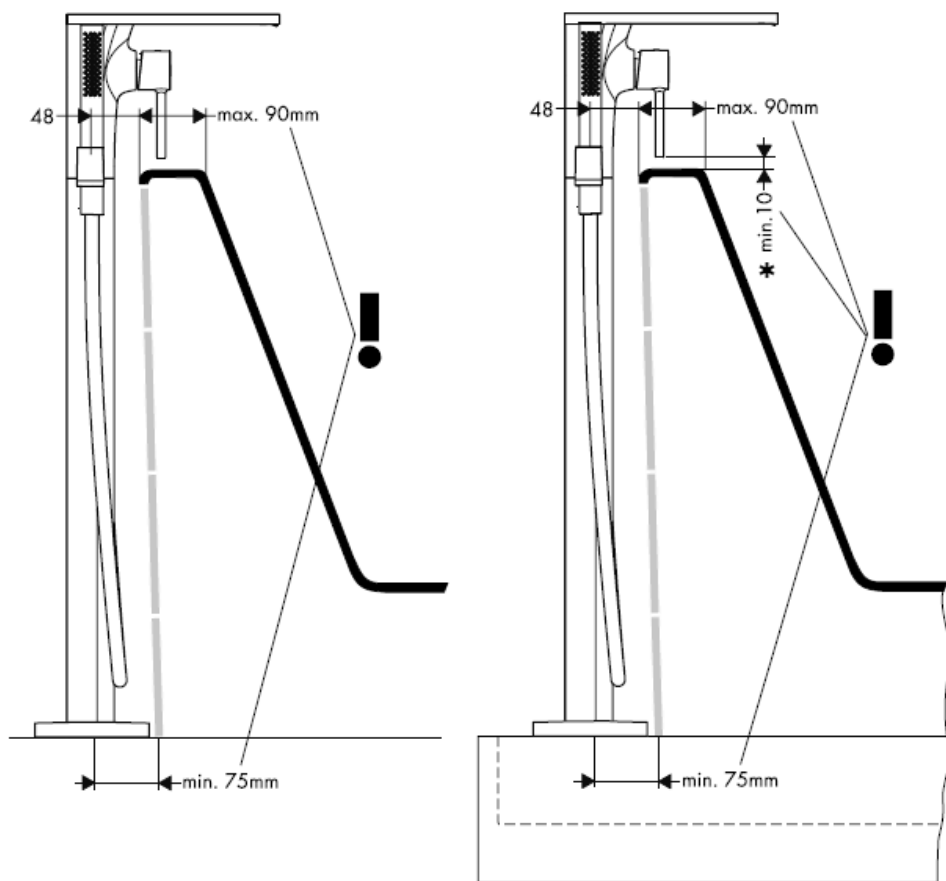

* < 10 min = jeu de rallonge 60 mm (référence 97686000)

Citterio 39451000

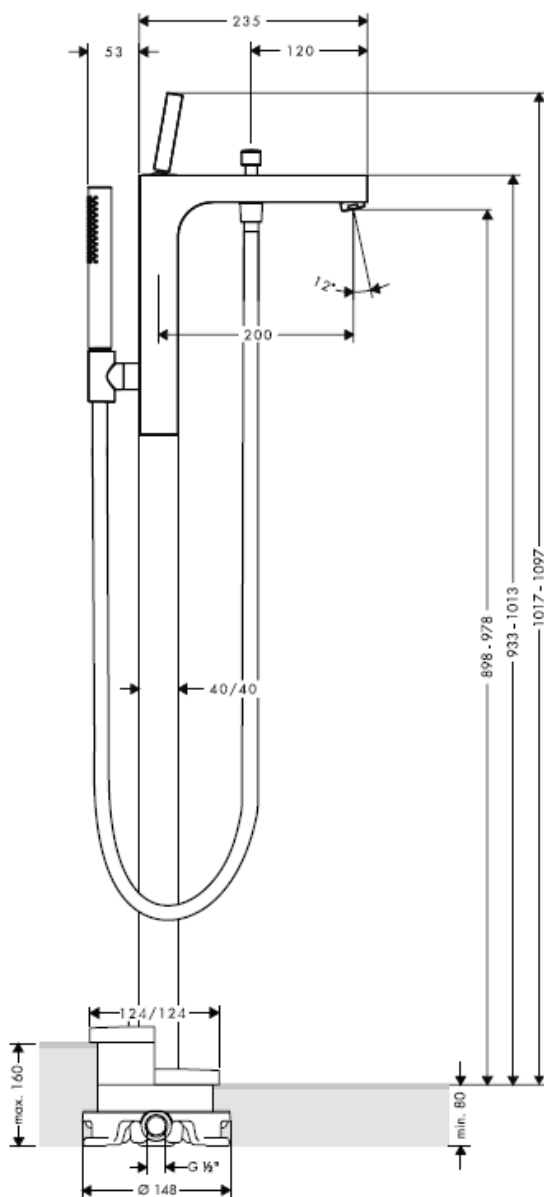

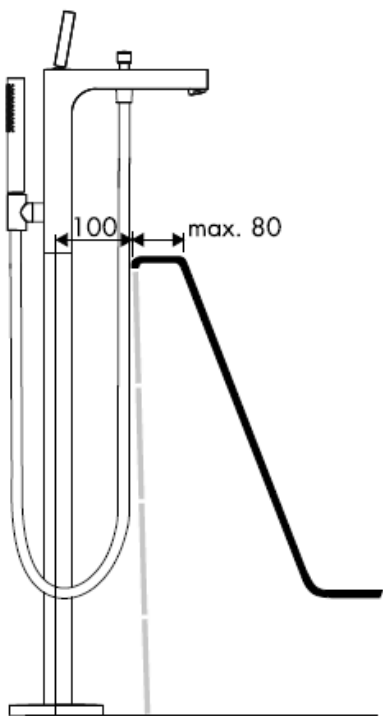

Attention! La robinetterie doit être installée, rincée et contrôlée conformément aux normes valables!

Starck 10452180

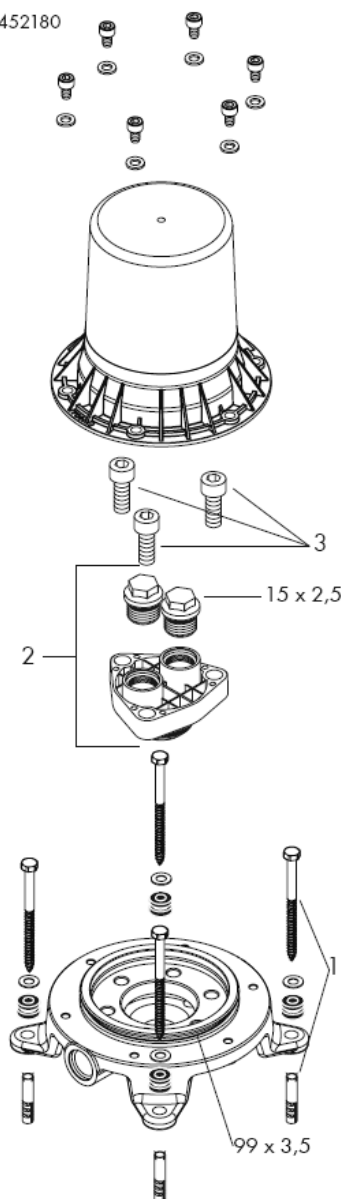

Montreux 16549180

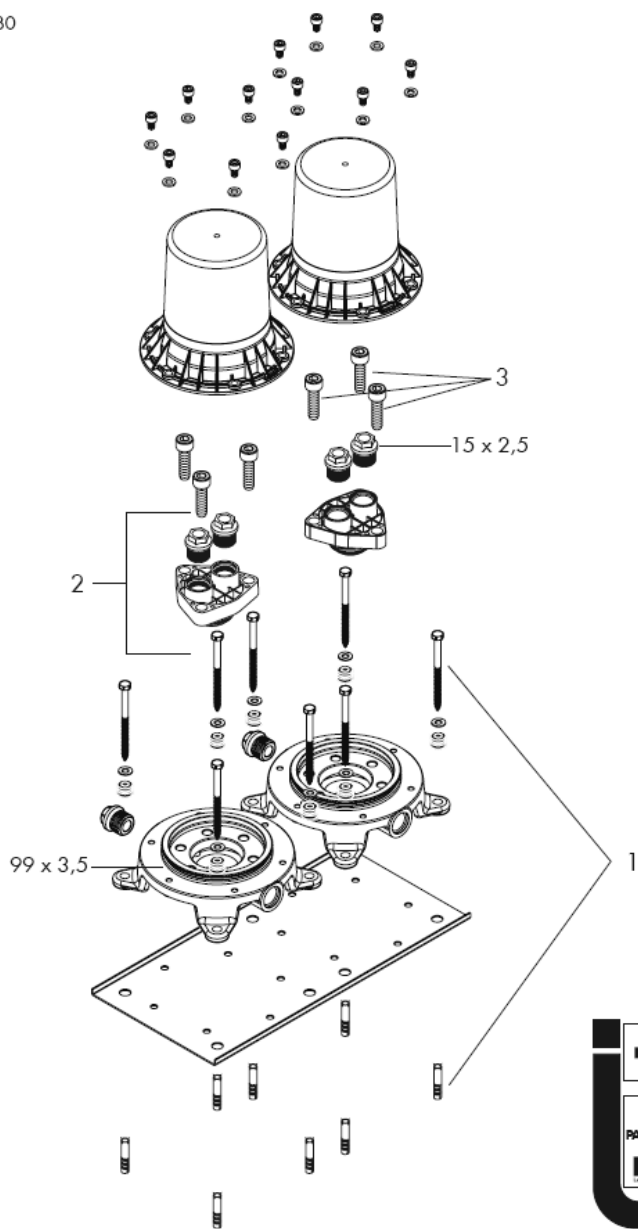

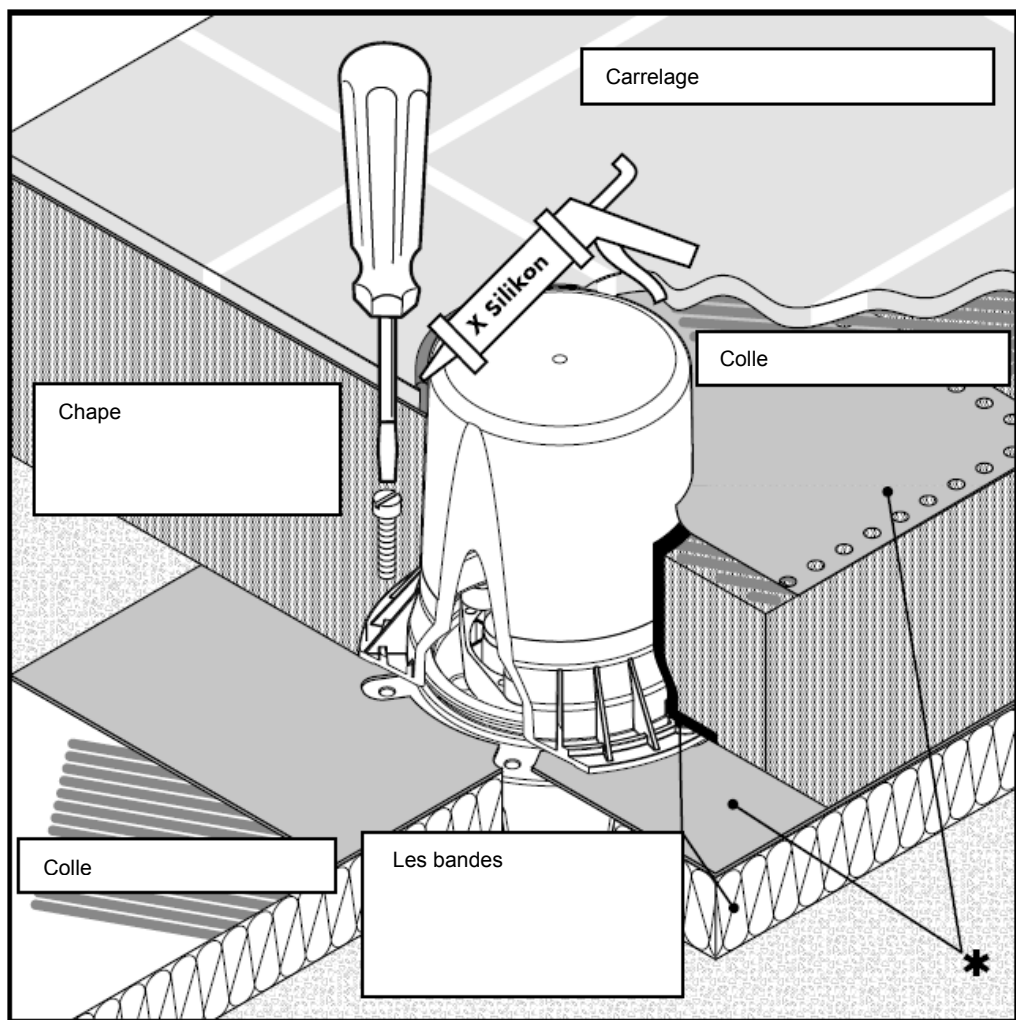

* une lamelle disponible en option

X Silicone (sans acide acétique!)

Montage

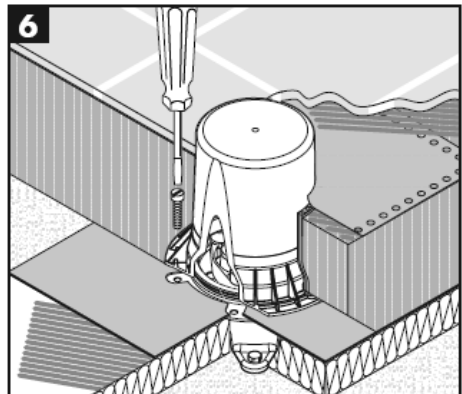
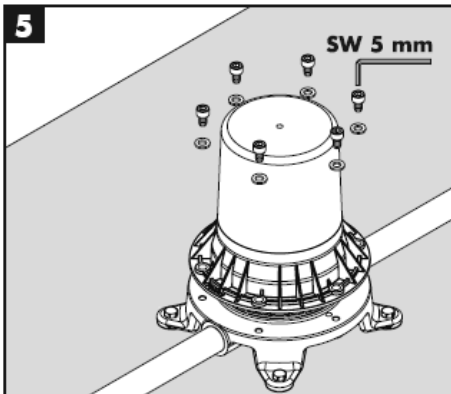
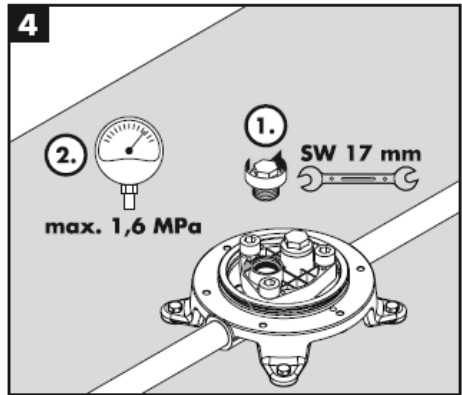
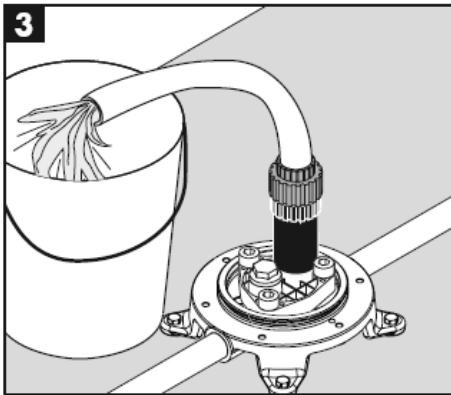
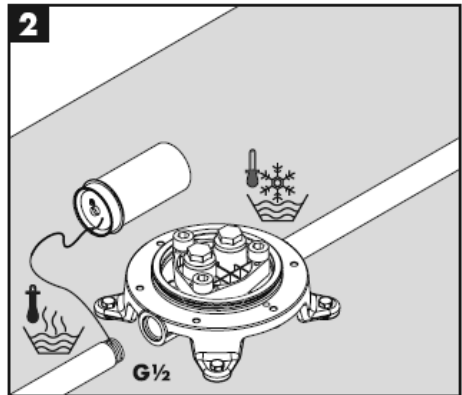
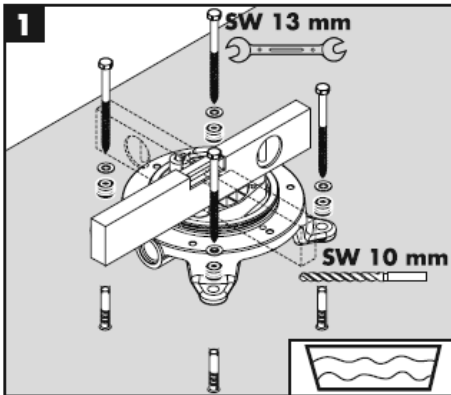

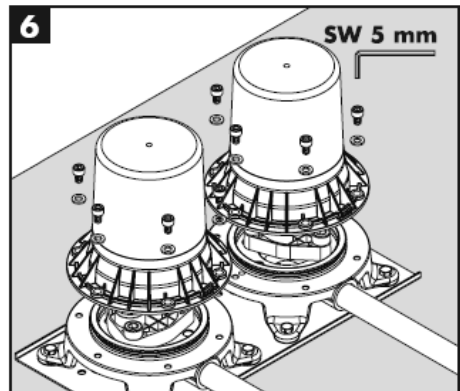
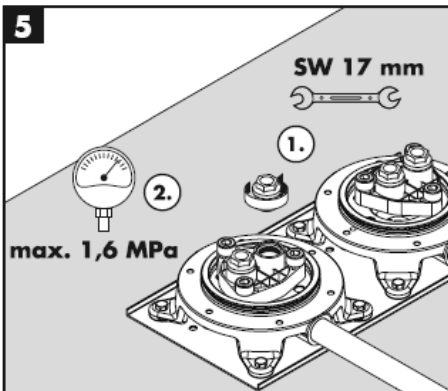
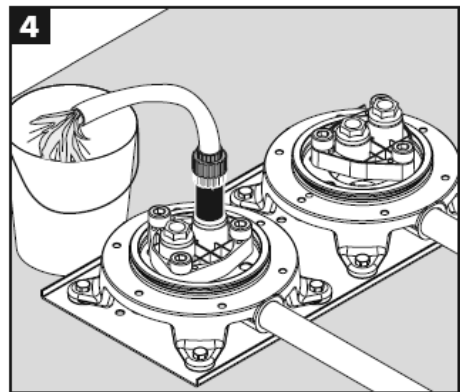
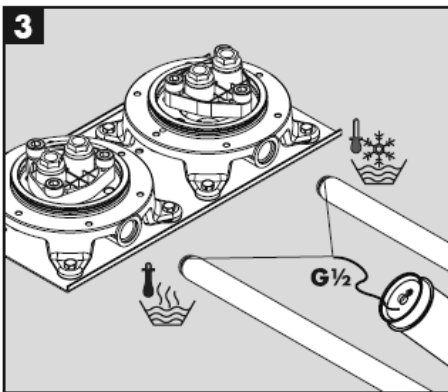
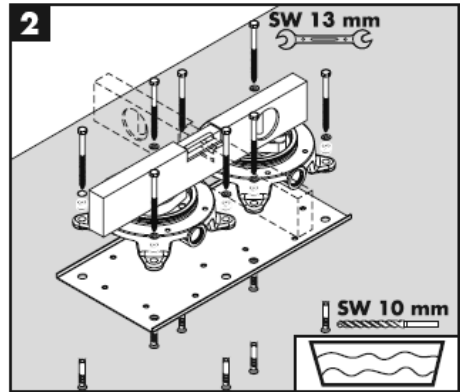
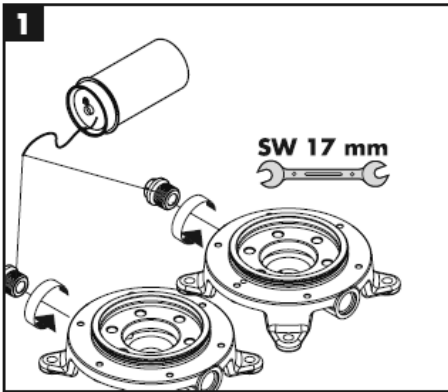

Montage

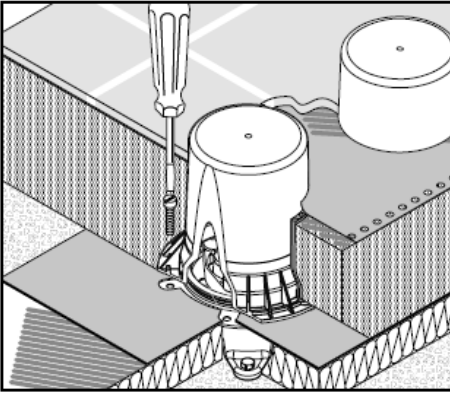

Français

Informations techniques

Pression de service autorisée: max. 1 MPa
Pression de service conseillée: 0,1 – 0,5 MPa
Pression maximum de contrôle: 1,6 MPa
(1 MPa = 10 bar = 147 PSI)
Température max. d'eau chaude: max. 80° C
Température recommandée: 65° C

Pièces détachées voir pages 10 – 11

set de fixation 96260000
set de joint plat 96459000
hexagon socket screw M 10 x 35 97670000

Accessoires en option

* lamelle 96441000
(ne fait pas partie de la fourniture)

Classification acoustique et débit

	DVGW	P-IX	SVGW	ACS	NF	WRAS	KIWA
10452180				x		X	
16549180		PA-IX 18729/ICB					

hansgrohe

assembly instructions

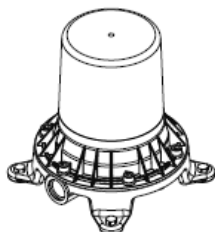

Starck
10452180

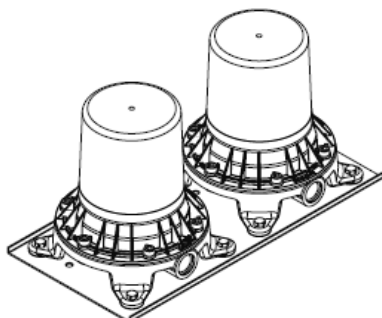

Montreux
16549180

AXOR[®]

hansgrohe

Starck 10458XXX

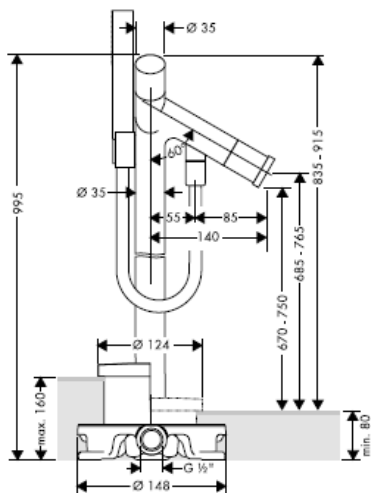

Starck 10060XXX

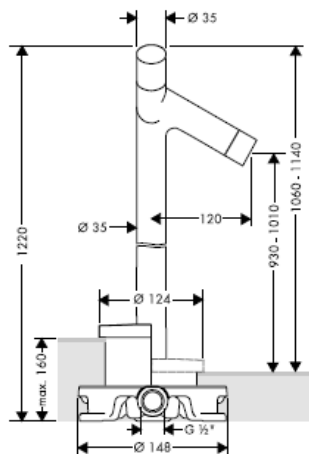

Starck 10456XXX

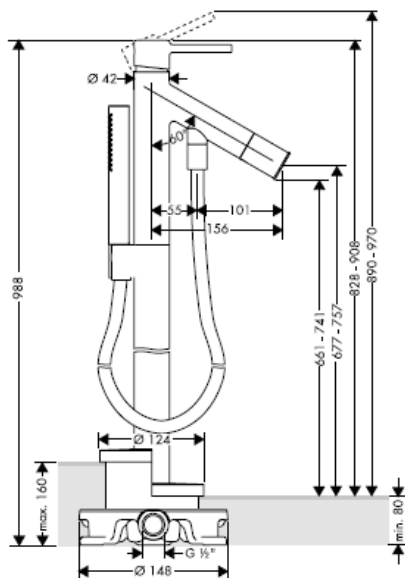

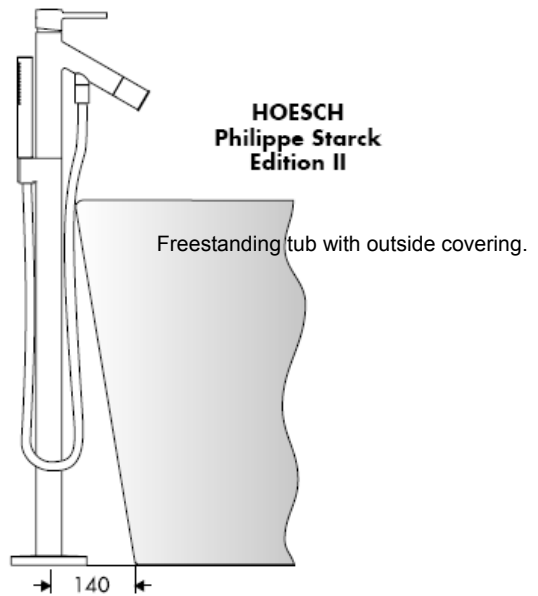
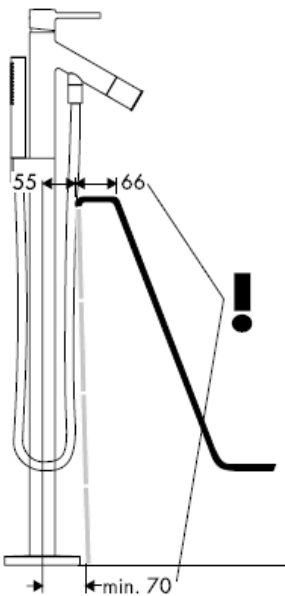
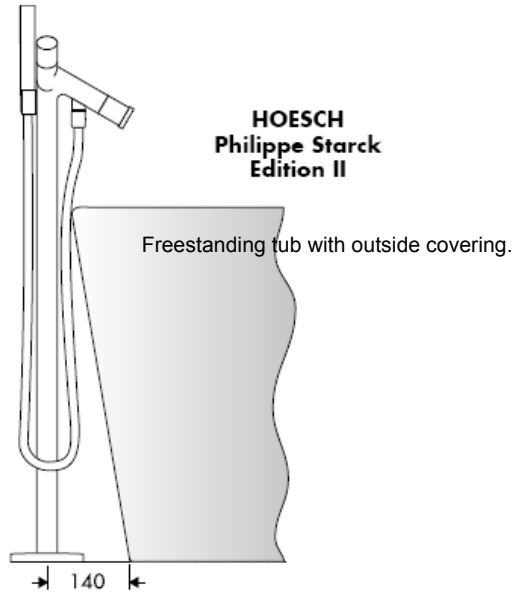
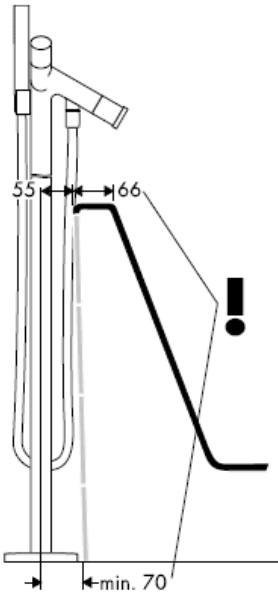

Starck X 10406000

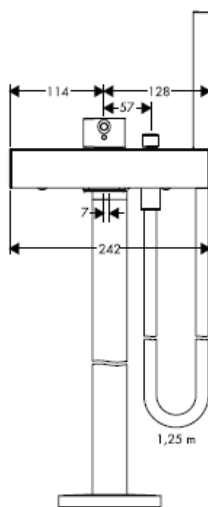
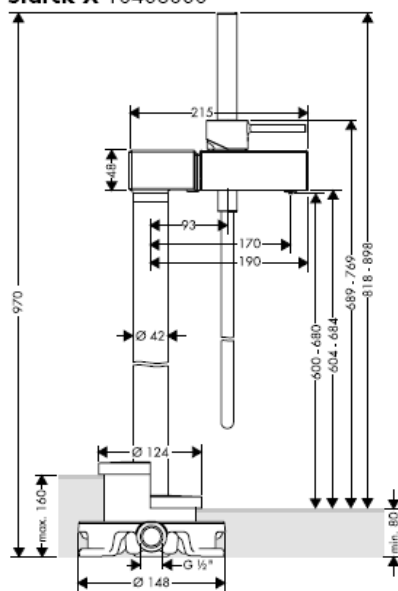

Montreux 16547XXX

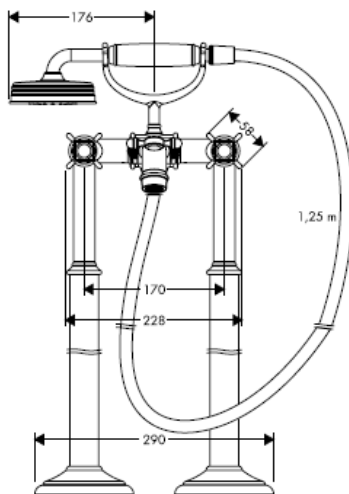
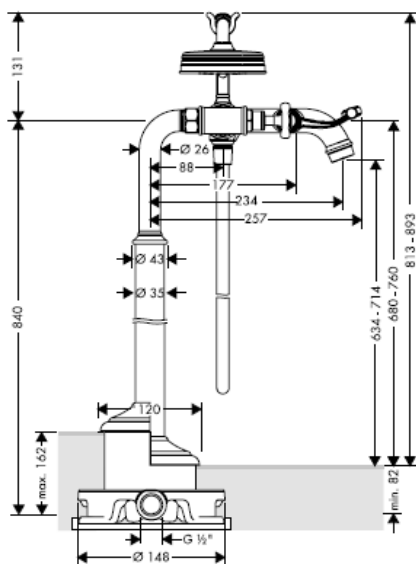

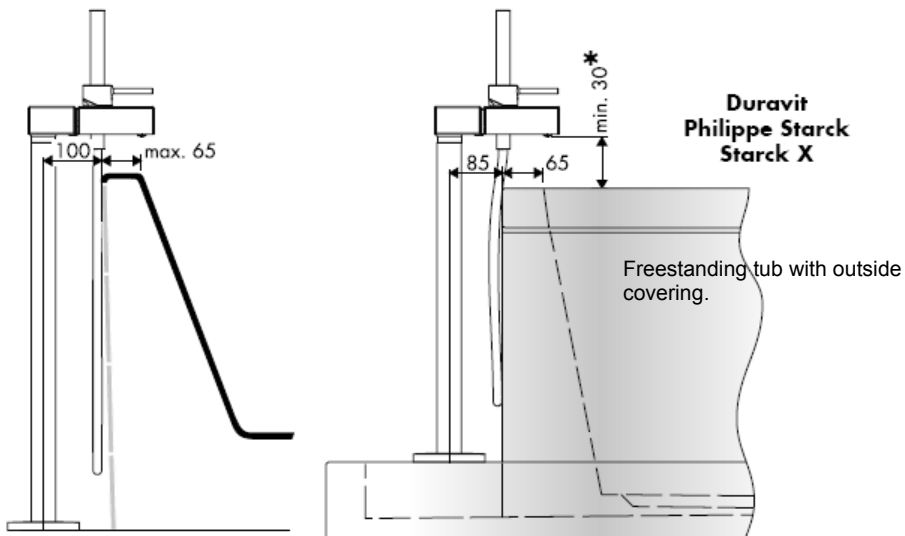

* < 30 min = extension 60 mm (article number 97686000)



Massaud 18450000

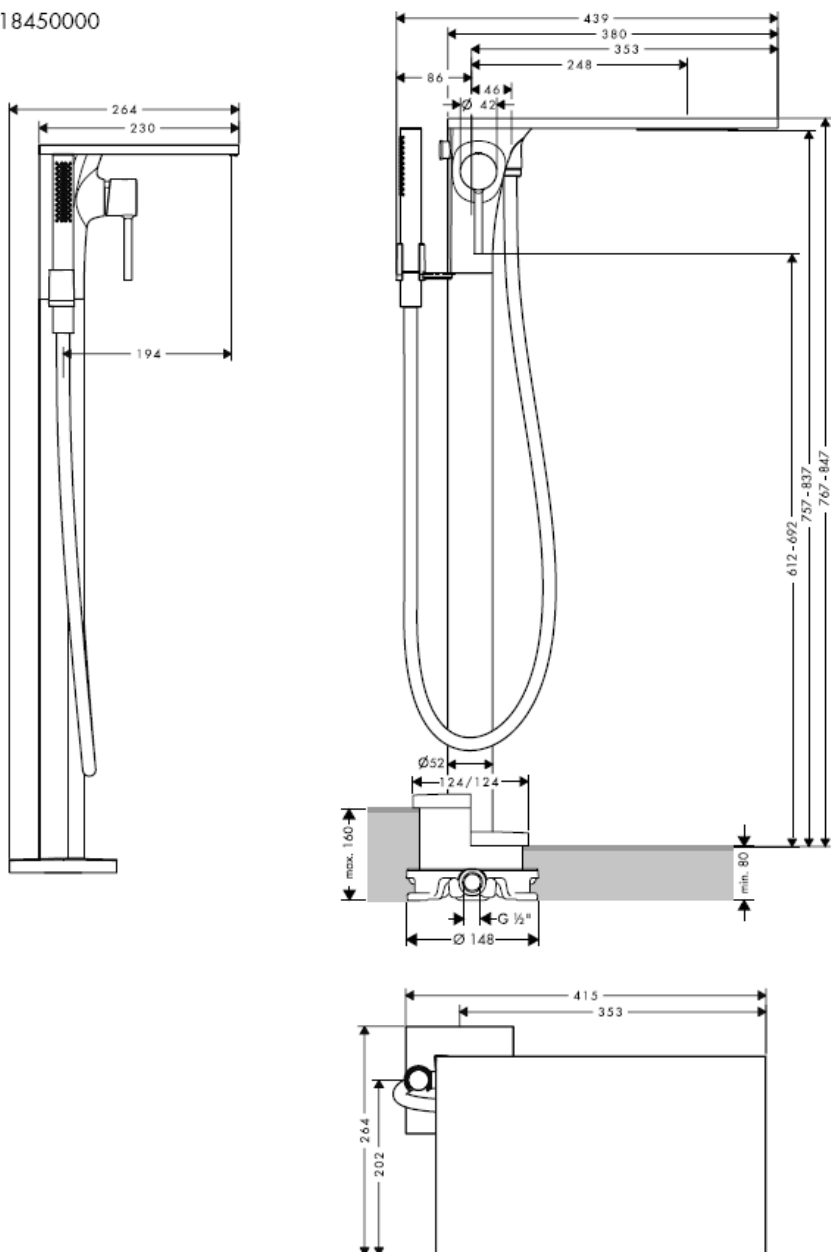

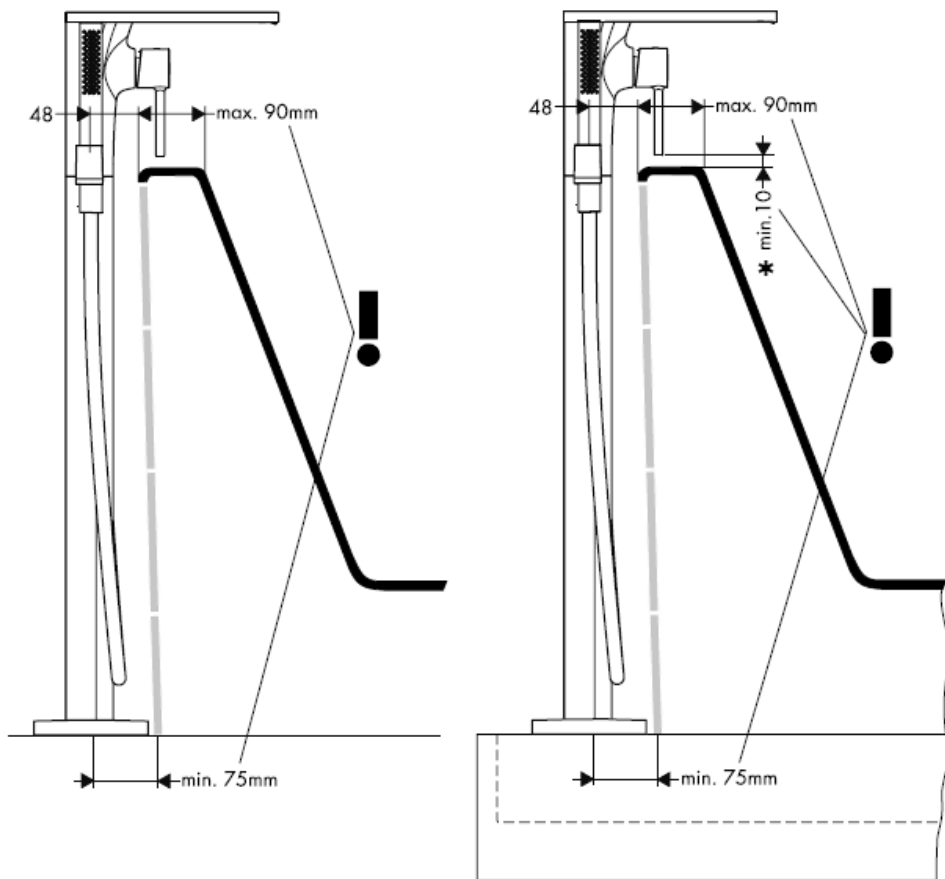

* < 10 min = extension 60 mm (article number 97686000)

Citterio 39451000

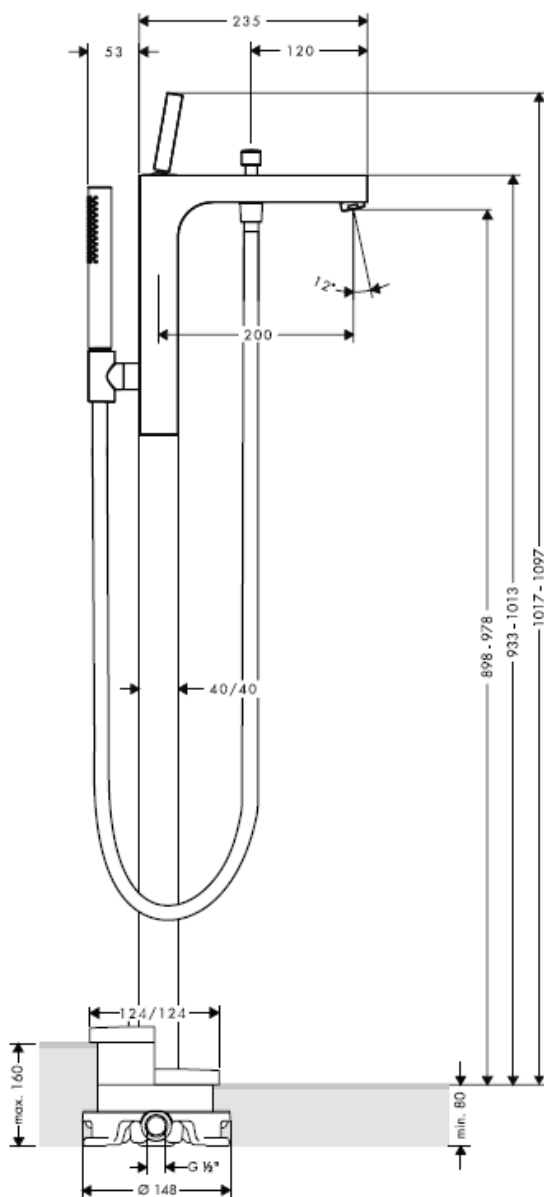

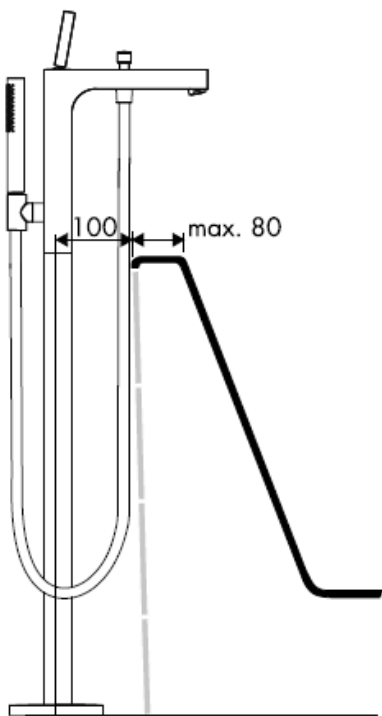

Important! The fitting must be installed, flushed and tested after the valid norms!

Starck 10452180

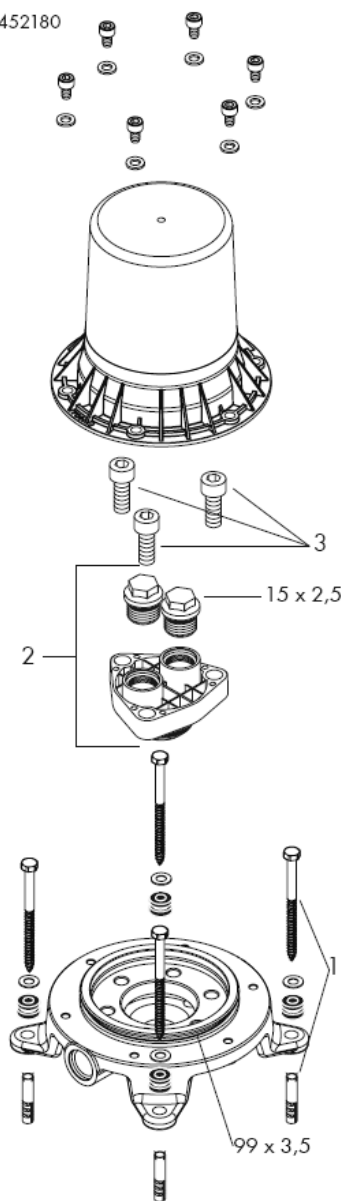

Montreux 16549180

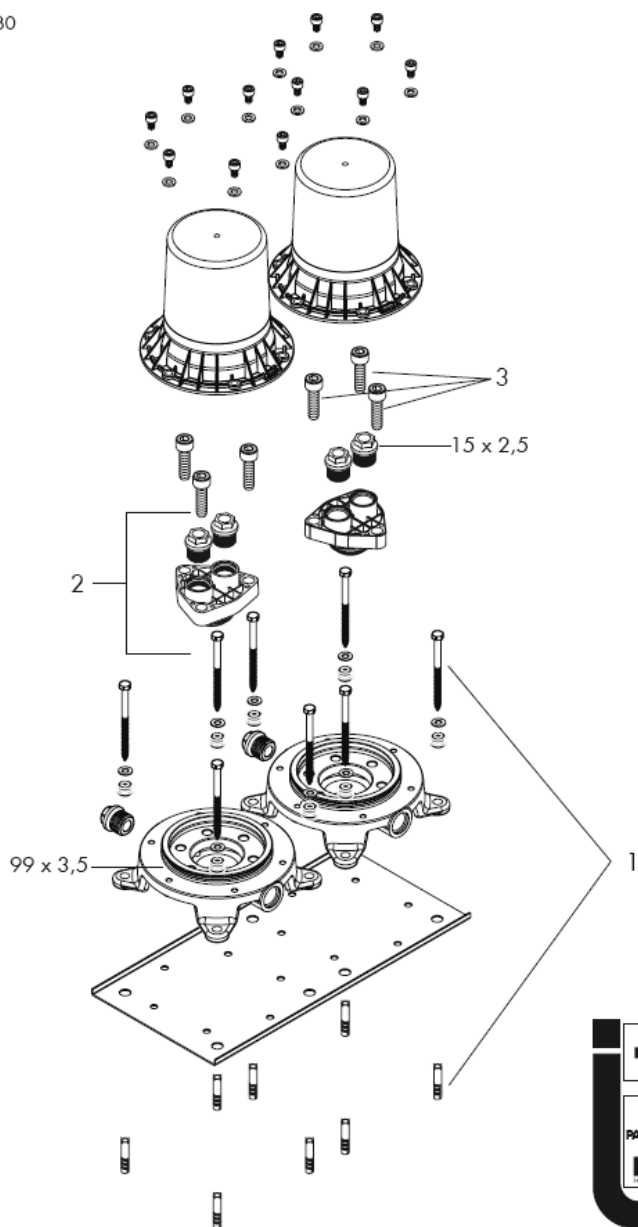

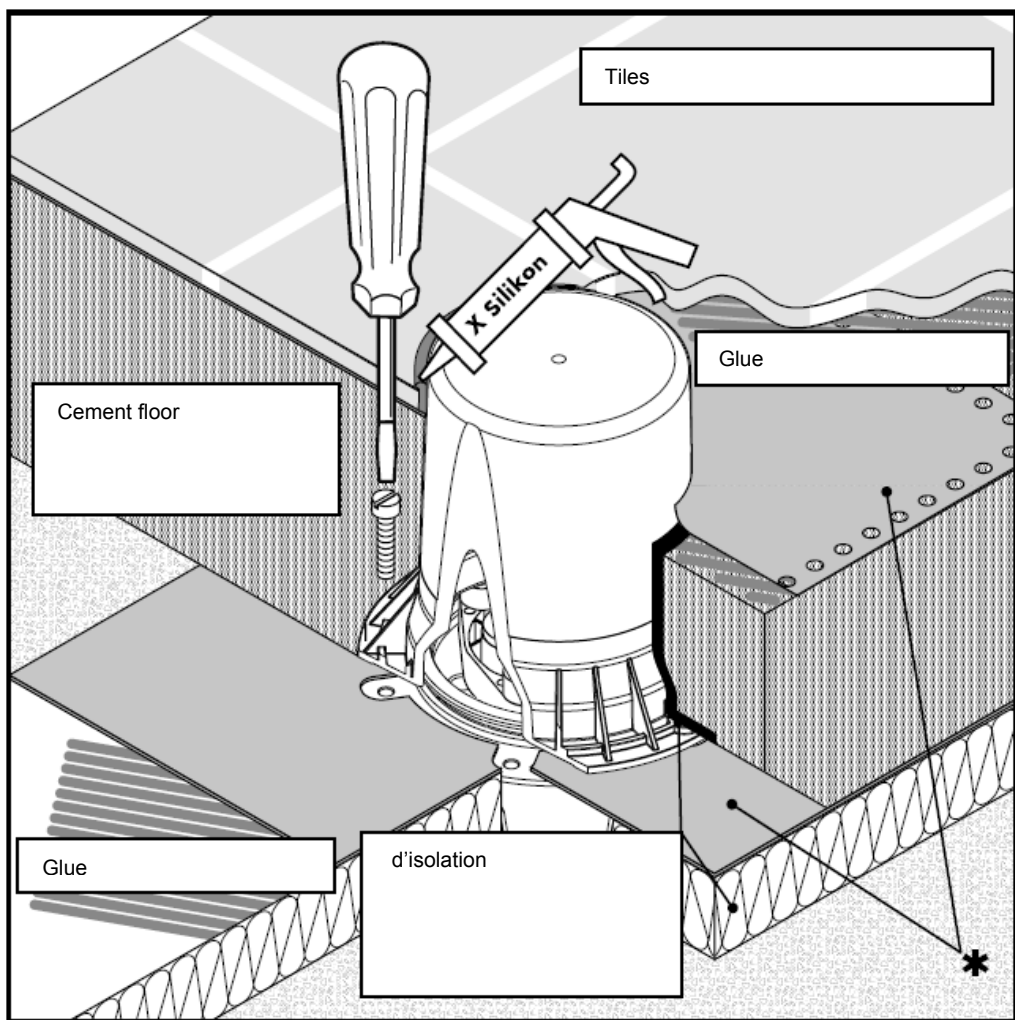

* if necessary, please order sealing foil

X Silicone (free from acetic acid!)

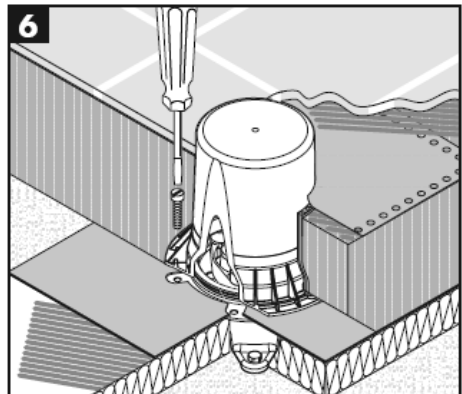
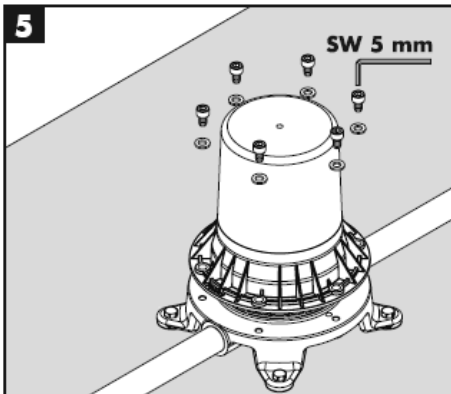
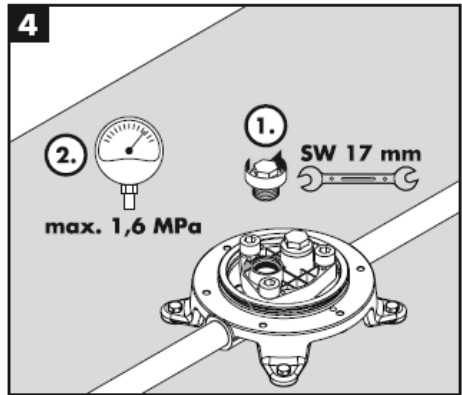
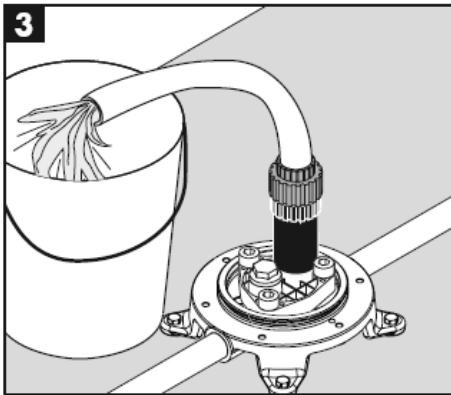
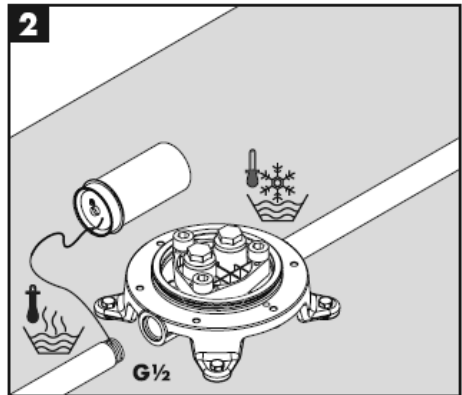
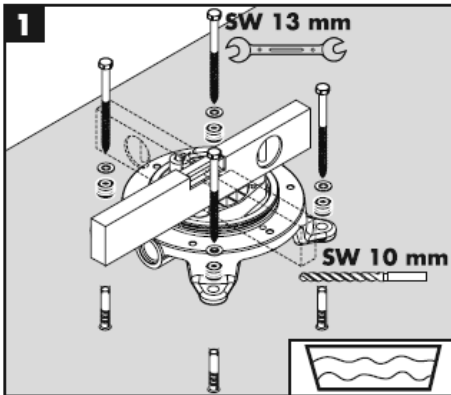

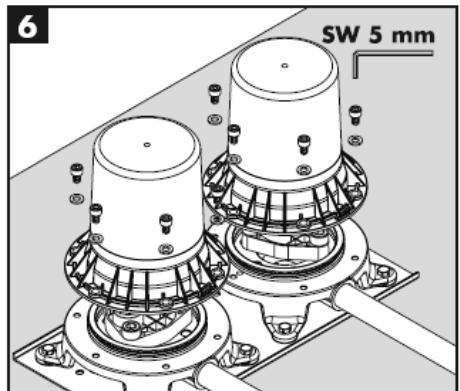
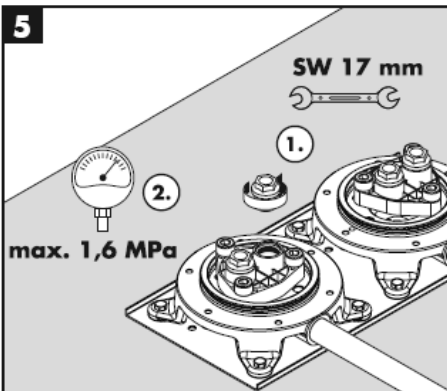
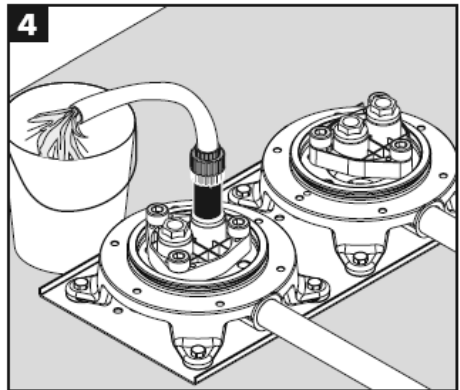
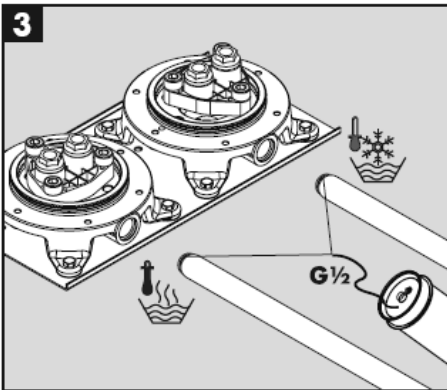
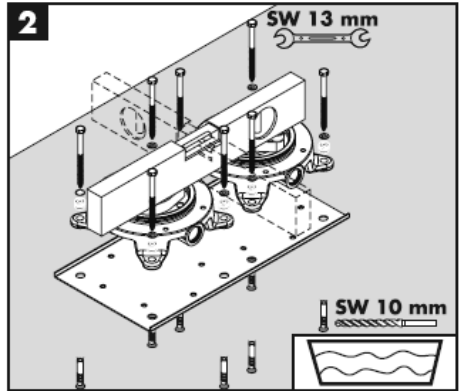
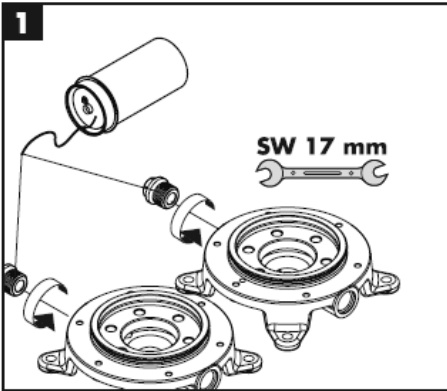

Assembly

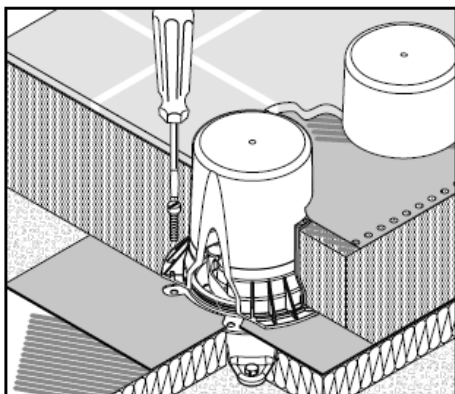

English

Technical Data

Operating pressure:	max. 1 MPa
Recommended operating pressure:	0,1 – 0,5 MPa
Test pressure:	1,6 MPa
(1 MPa = 10 bar = 147 PSI)	
Hot water temperature:	max. 80° C
Recommended hot water temp.:	65° C

Spare parts see page 10 – 11

mounting kit	96260000
sealing set	96459000
hexagon socket screw M 10 x 35	97670000

Special accessories

* sealing foil (order as an extra)	96441000
---------------------------------------	----------

Test certificate

	DVGW	P-IX	SVGW	ACS	NF	WRAS	KIWA
10452180				x		X	
16549180		PA-IX 18729/ICB					

hansgrohe

Istruzioni per Installazione

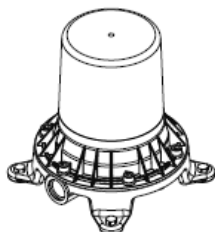

Starck
10452180

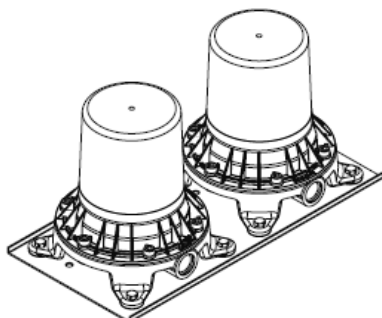

Montreux
16549180

AXOR[®]

hansgrohe

Starck 10458XXX

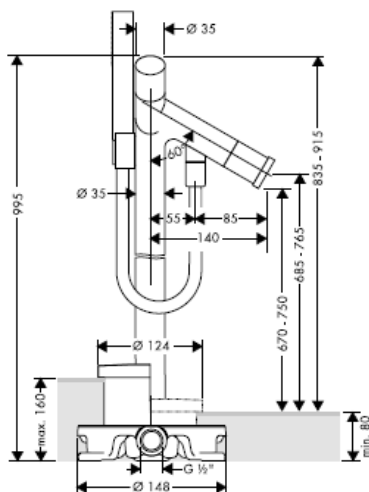

Starck 10060XXX

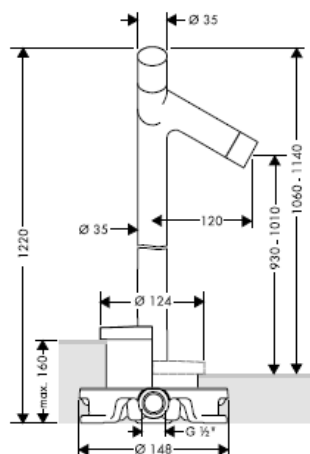

Starck 10456XXX

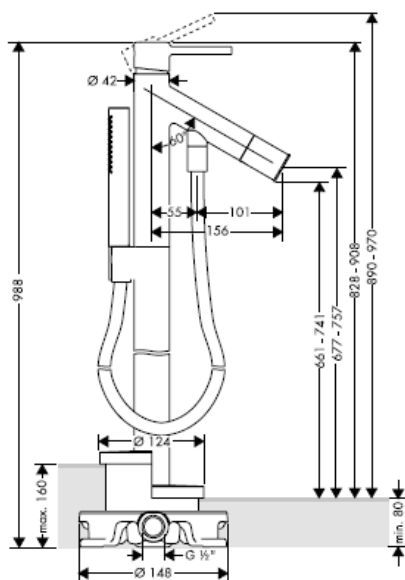

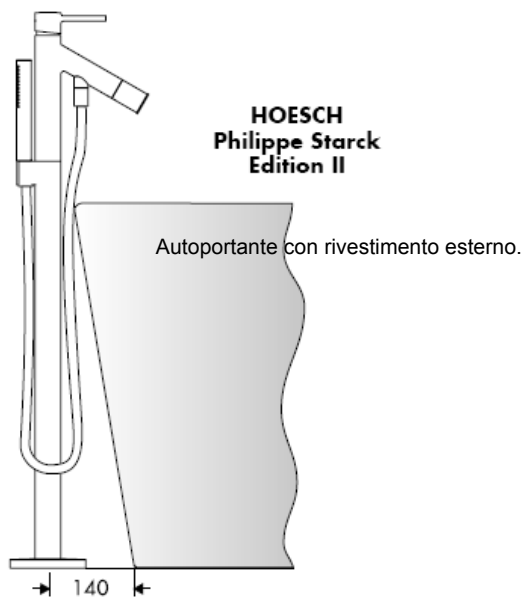
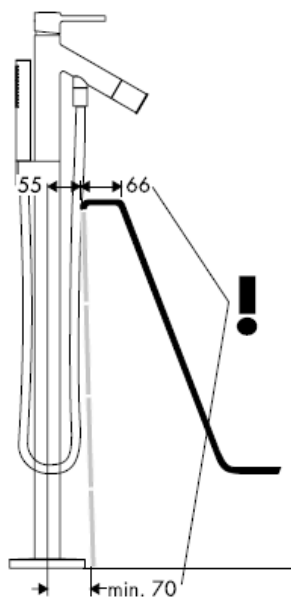
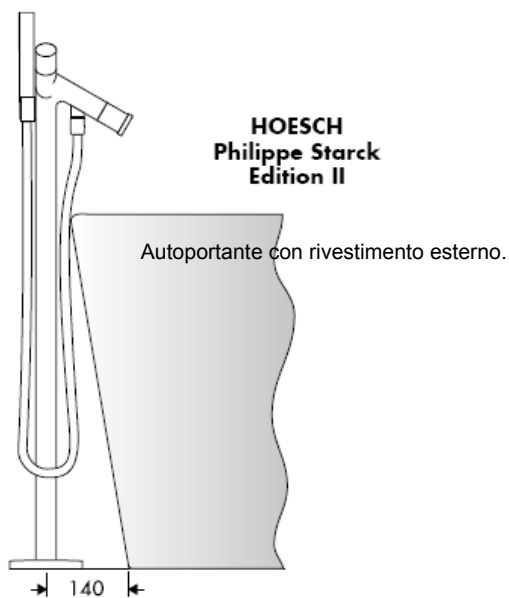

Starck X 10406000

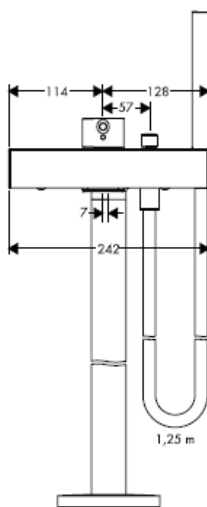
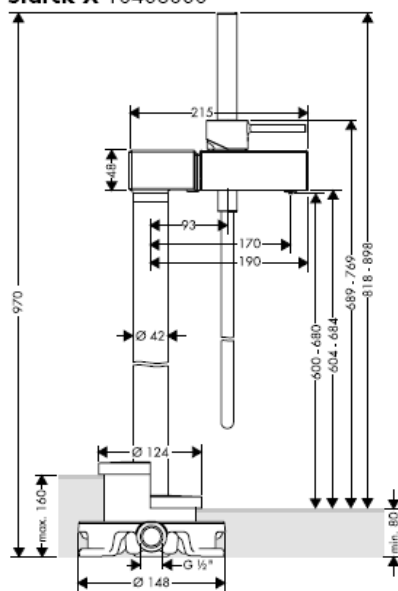

Montreux 16547XXX

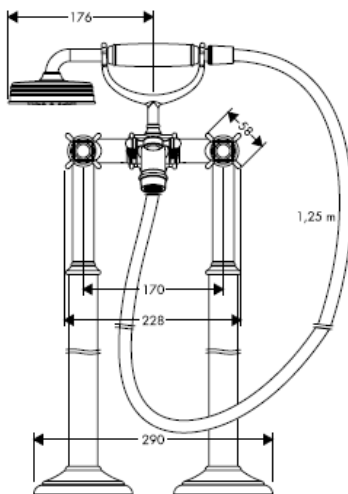
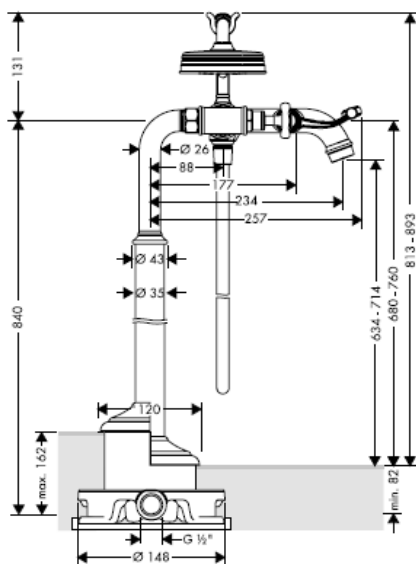

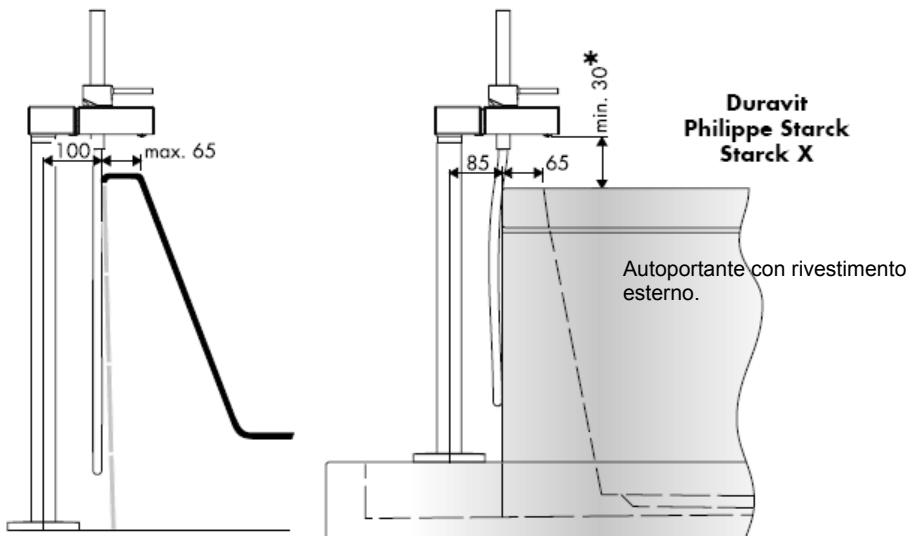

* < 30 min = Prolunga 60 mm (codice articolo 97686000)



Massaud 18450000

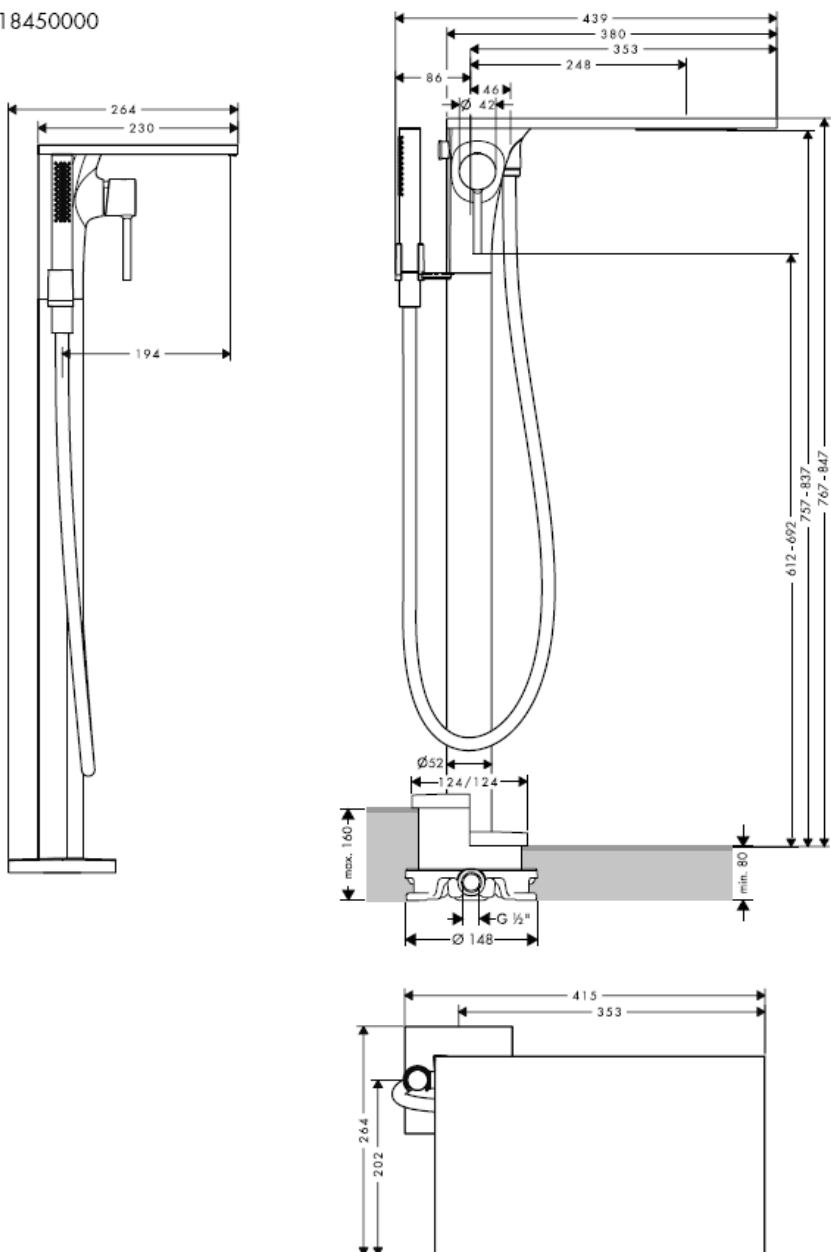

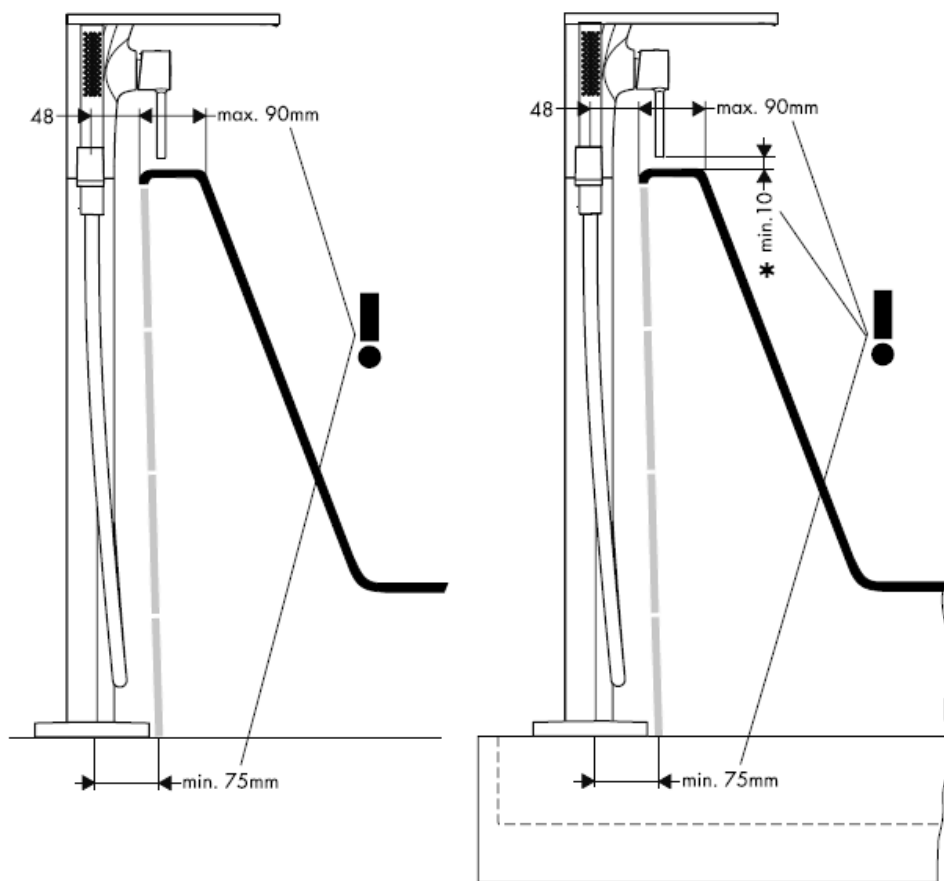

* < 10 min = Prolunga 60 mm (codice articolo 97686000)

Citterio 39451000

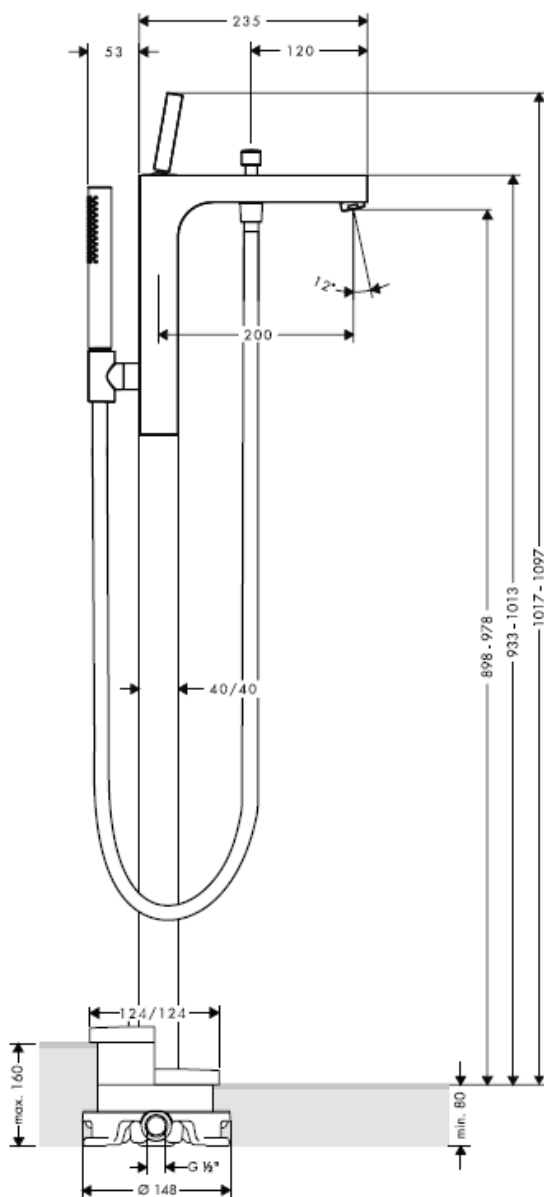

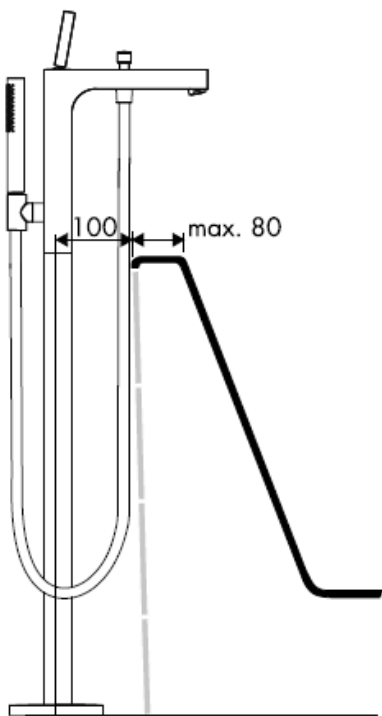

Attenzione! La rubinetteria deve essere installata, pulita e testata secondo le istruzioni riportate!

Starck 10452180

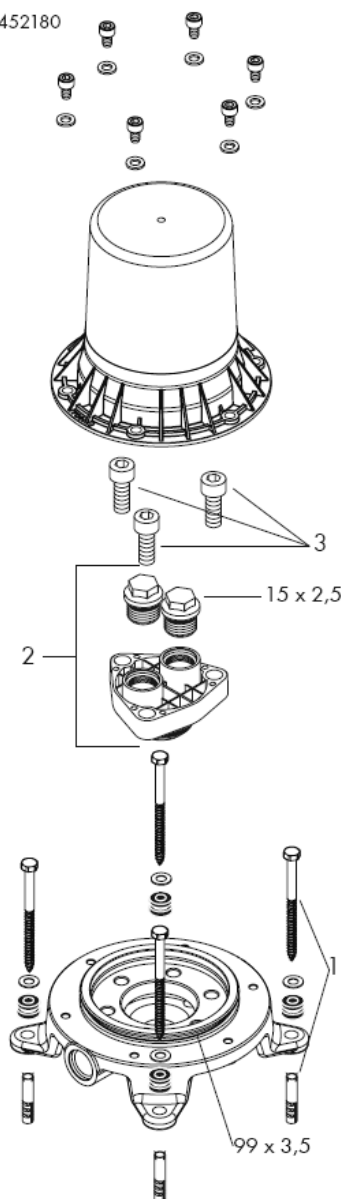

Montreux 16549180

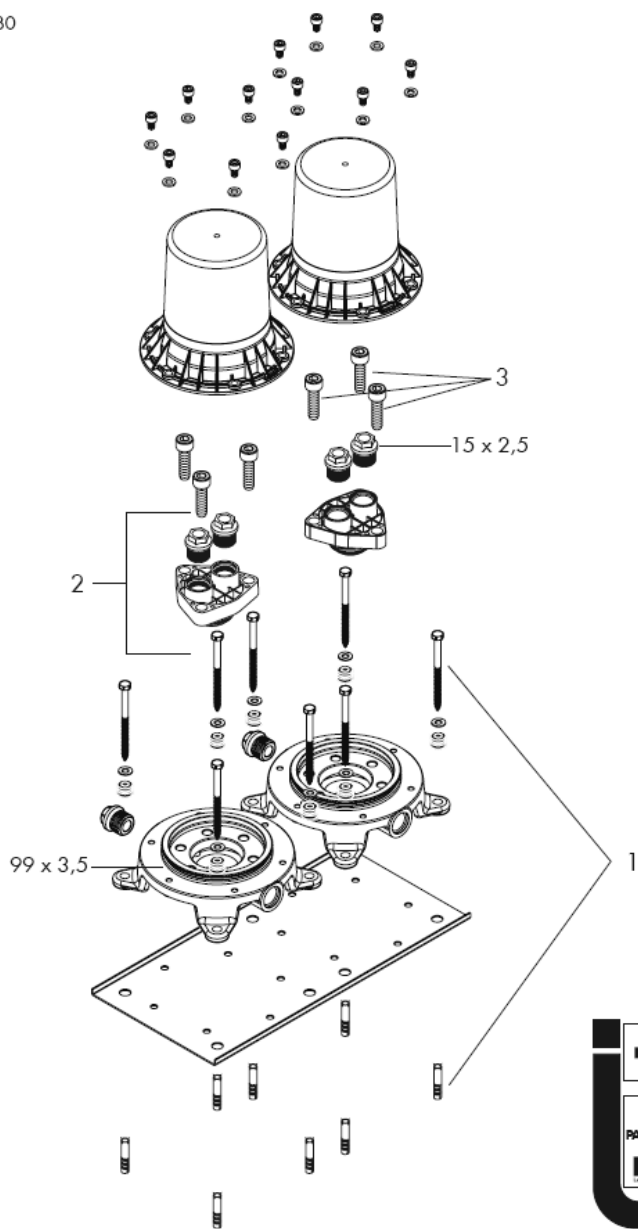

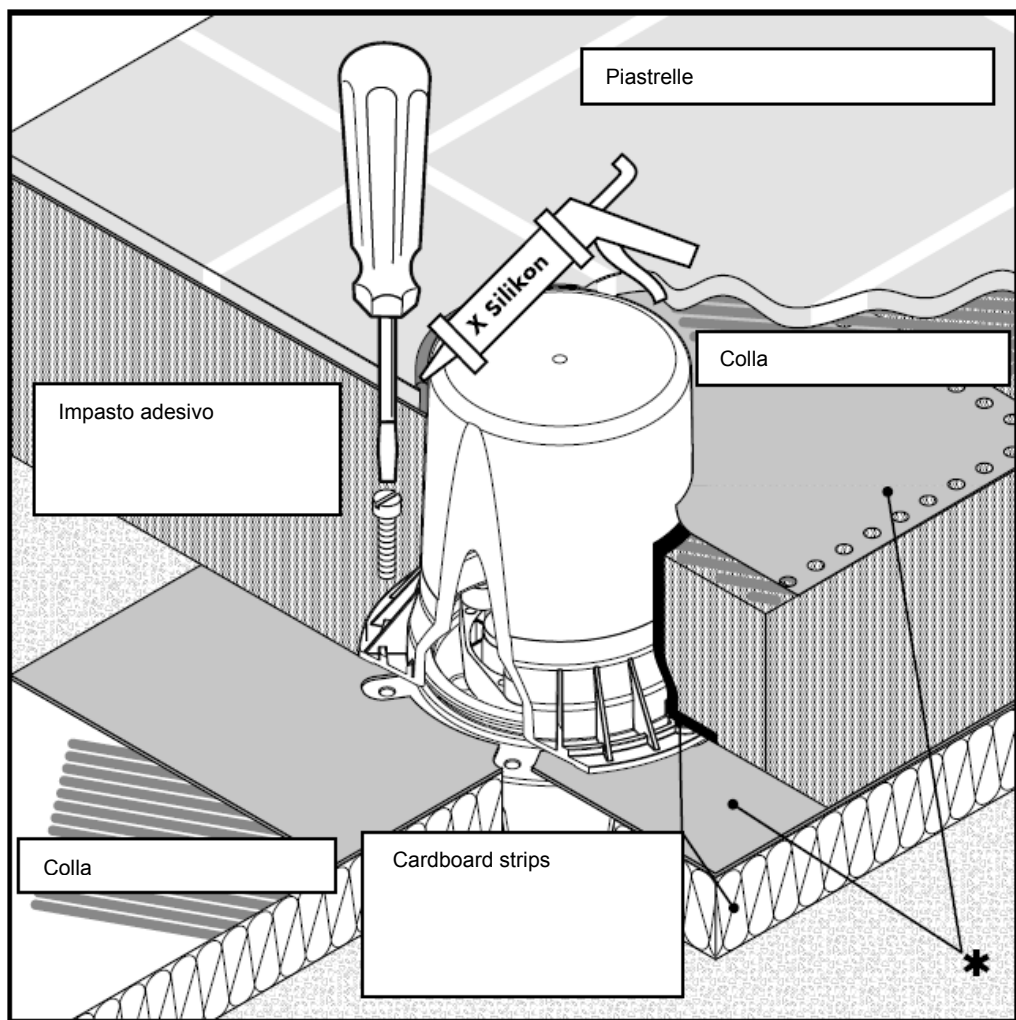

* disponibile in opzione guarnizione a
 fessura

X Silicone (esente da acido acetico!)

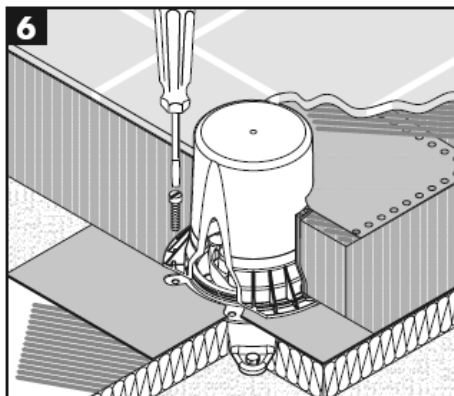
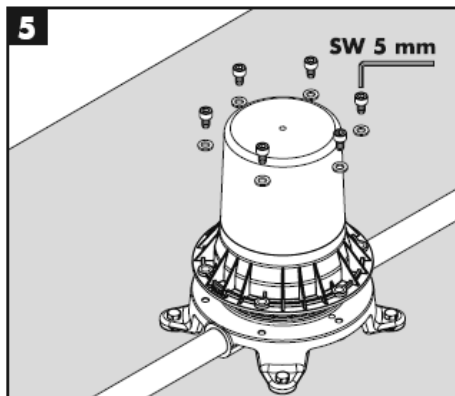
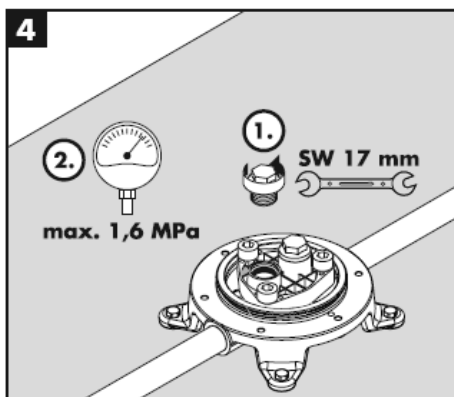
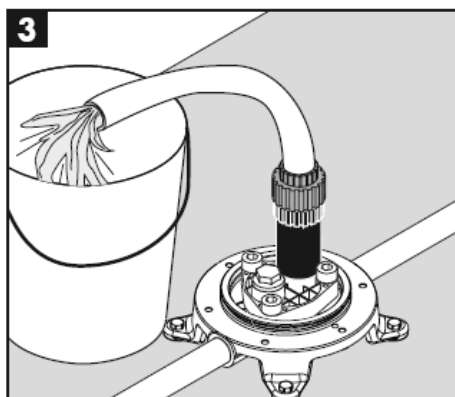
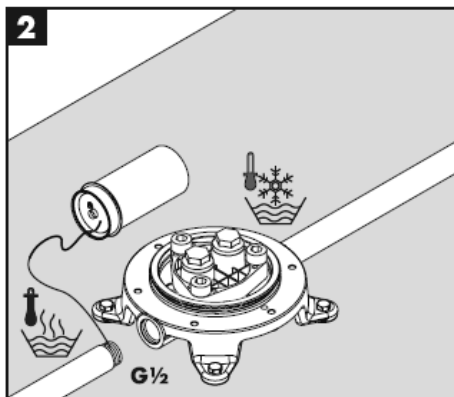
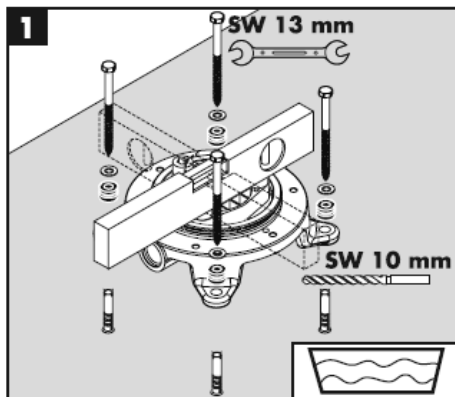

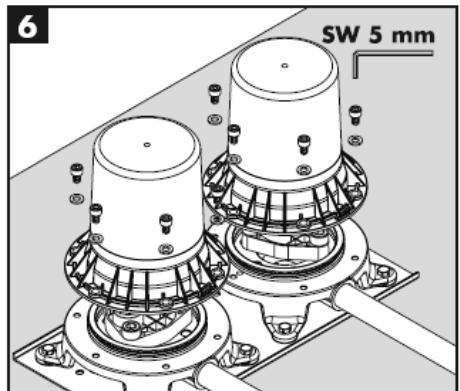
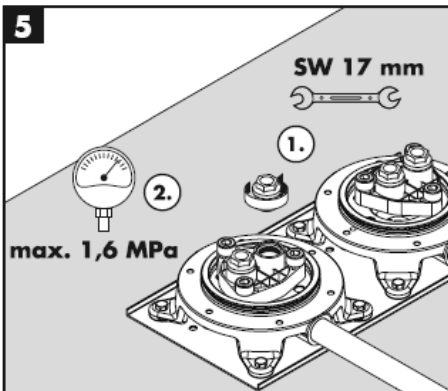
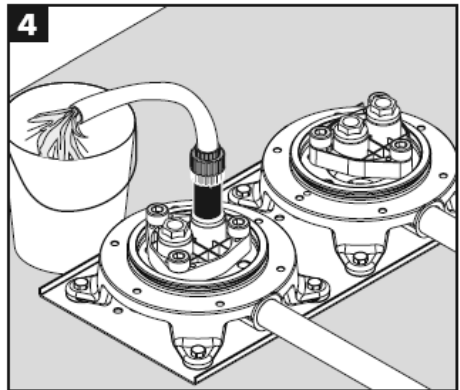
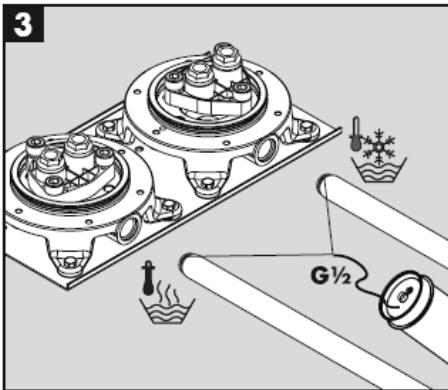
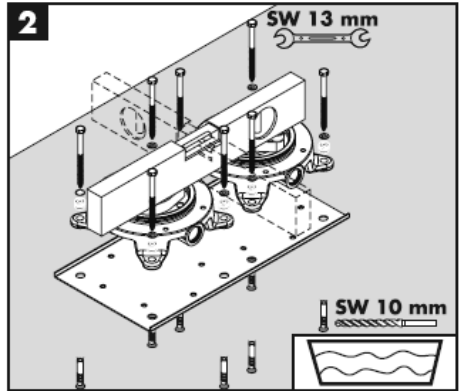
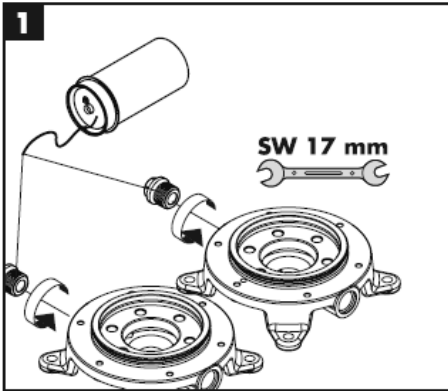

Montaggio

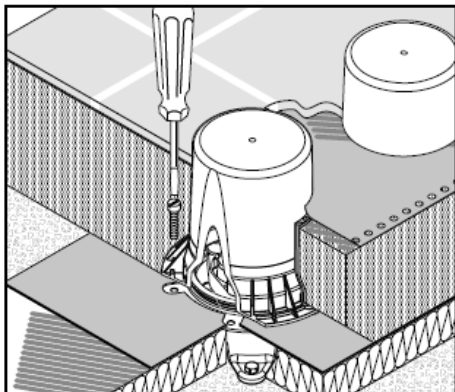

Italiano

Dati tecnici

Pressione d'uso:	max. 1 MPa
Pressione d'uso consigliata:	0,1 – 0,5 MPa
Pressione di prova: (1 MPa = 10 bar = 147 PSI)	1,6 MPa
Temperatura dell'acqua calda:	max. 80° C
Temp. dell'acqua calda consigliata:	65° C

Parti di ricambio vedi pagg. 10 – 11

set di fissaggio	96260000
set di guarnizioni	96459000
vite a testa cilindrica M 10 x 35	97670000

Accessori speciali

* guarnizione a flangia (non contenuto nel volume di fornitura)	96441000
--	----------

Segno di verifica

	DVGW	P-IX	SVGW	ACS	NF	WRAS	KIWA
10452180				x		X	
16549180		PA-IX 18729/ICB					

hansgrohe

Instrucciones de montaje

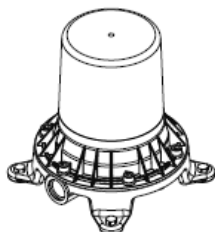

Starck
10452180

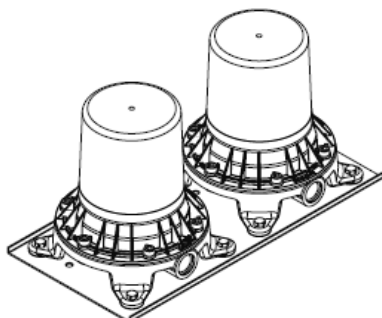

Montreux
16549180

AXOR[®]

hansgrohe

Starck 10458XXX

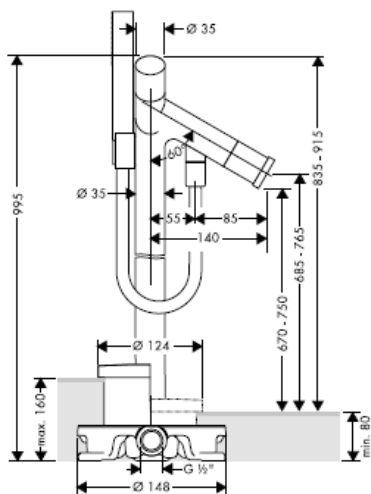

Starck 10060XXX

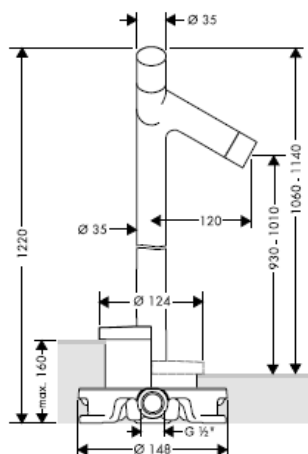

Starck 10456XXX

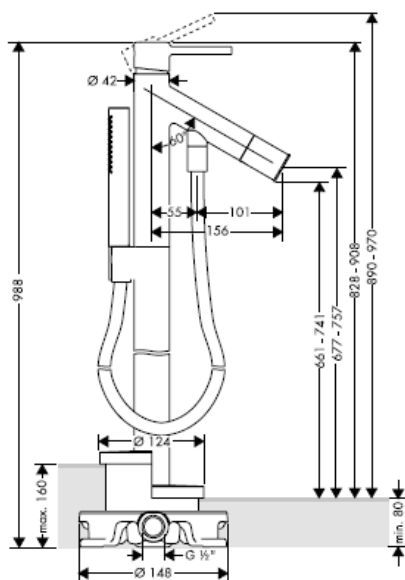

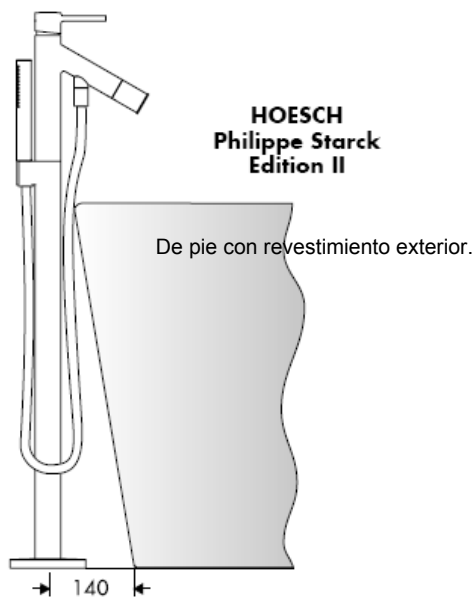
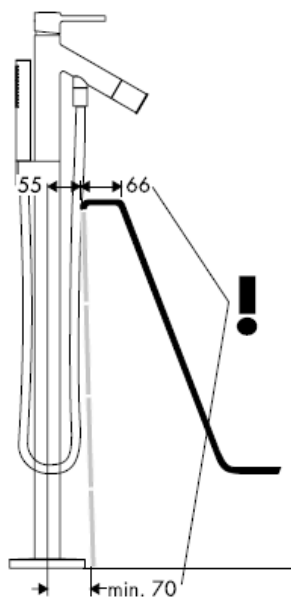
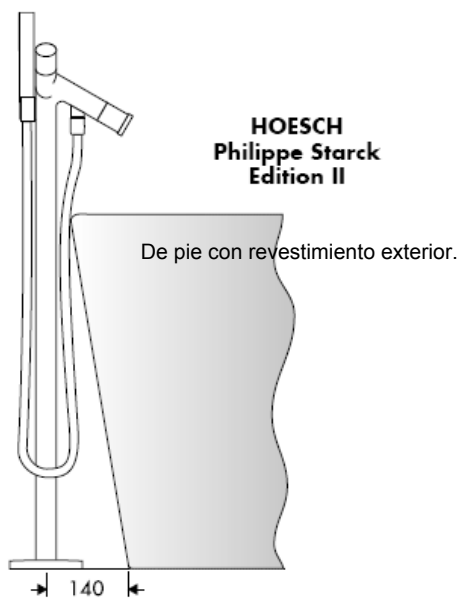

Starck X 10406000

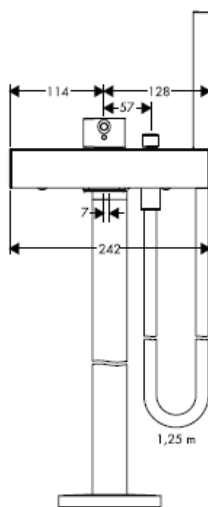
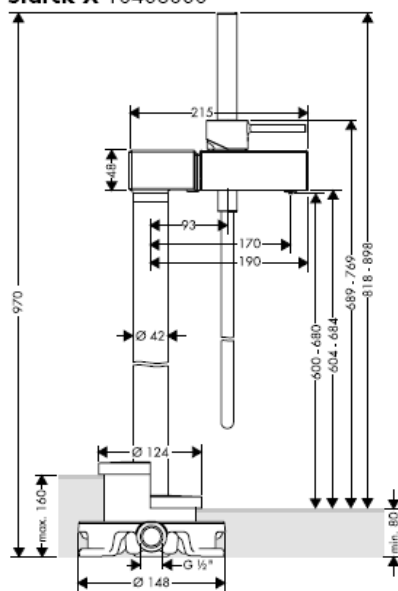

Montreux 16547XXX

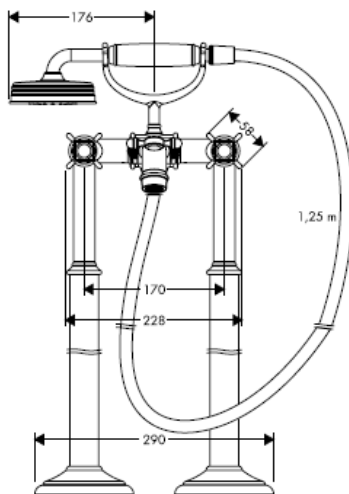
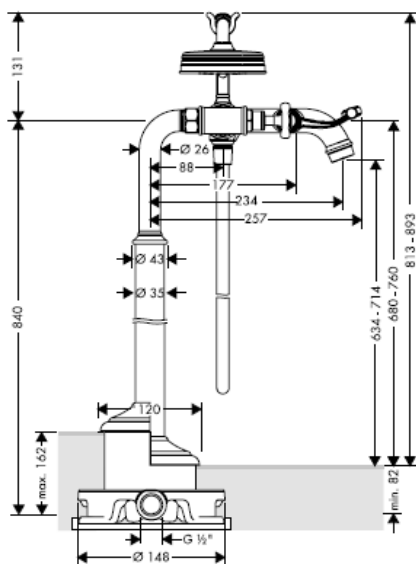

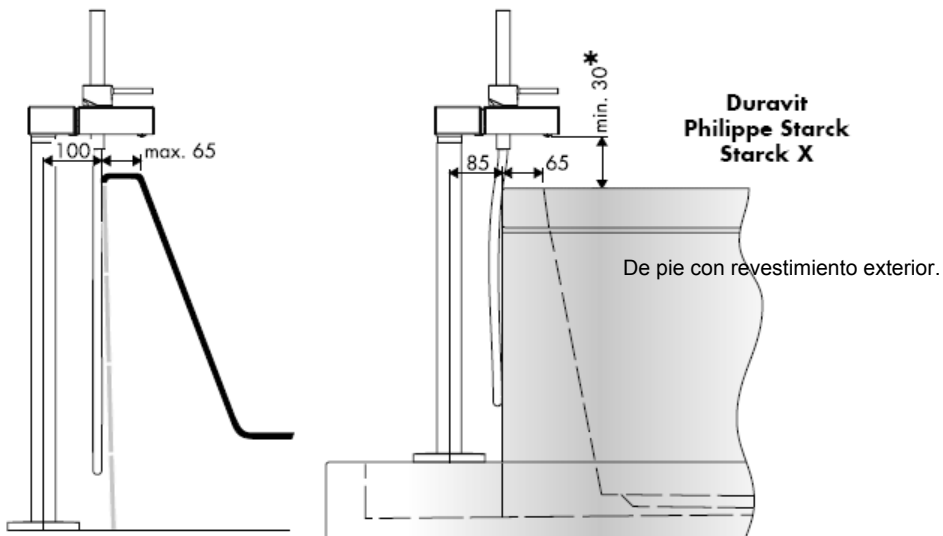

* < 30 min = Prolongación 60 mm (artículo número 97686000)

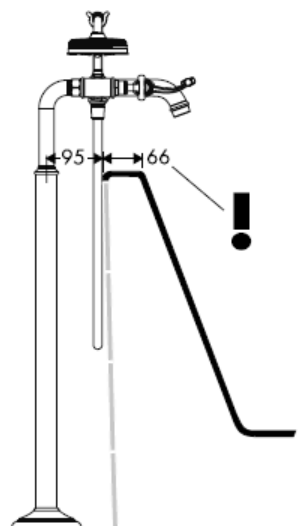

Massaud 18450000

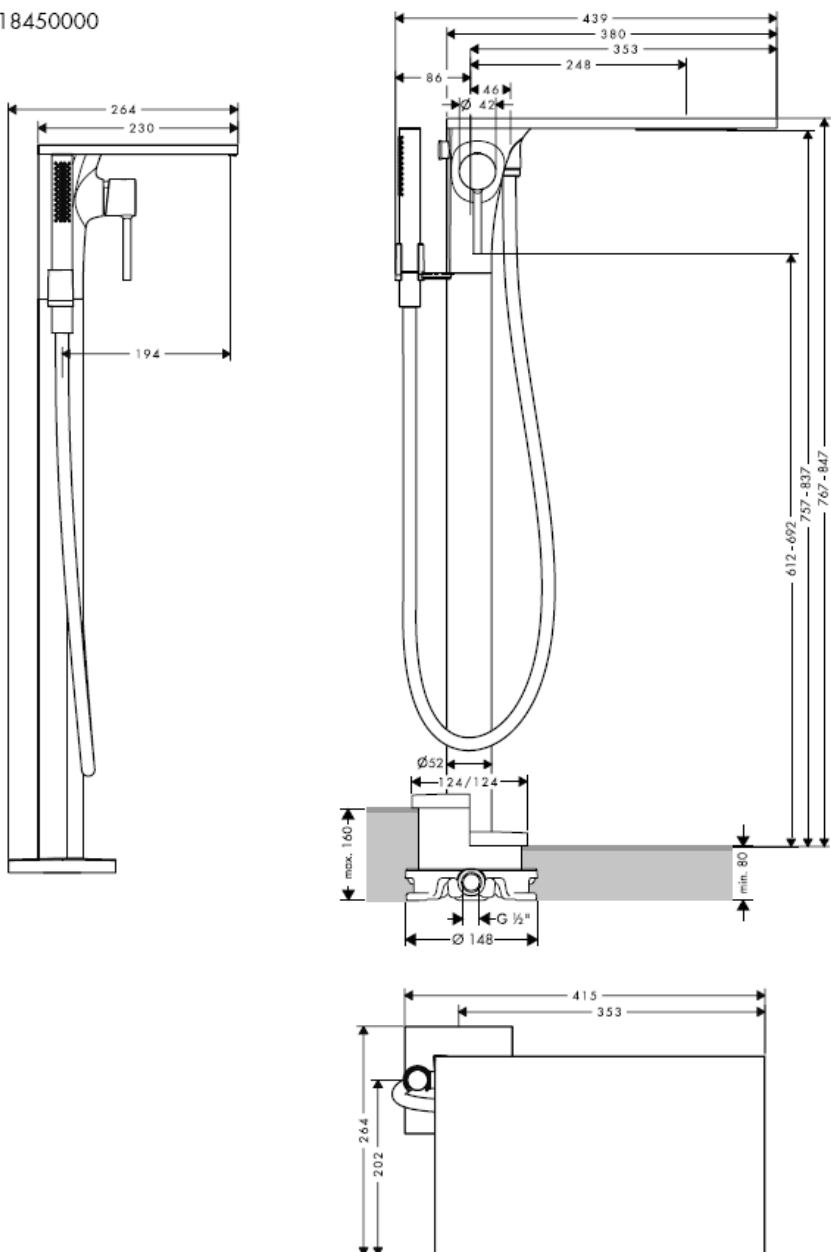

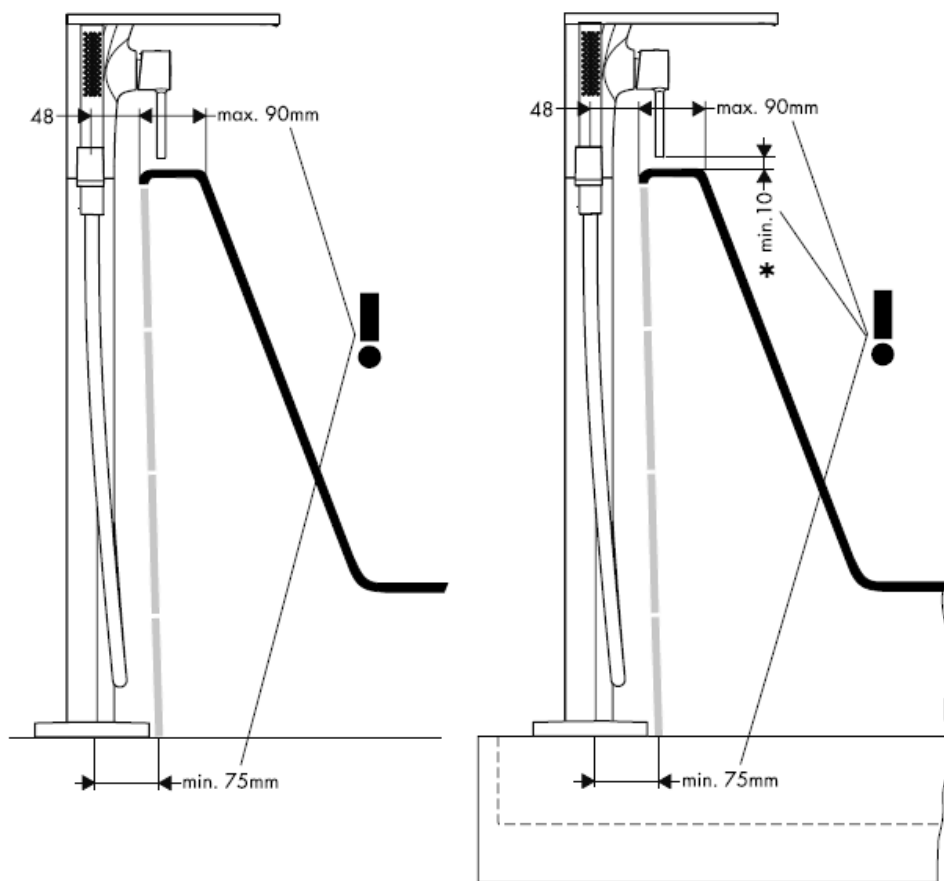

* < 10 min = Prolongación 60 mm (artículo número 97686000)

Citterio 39451000

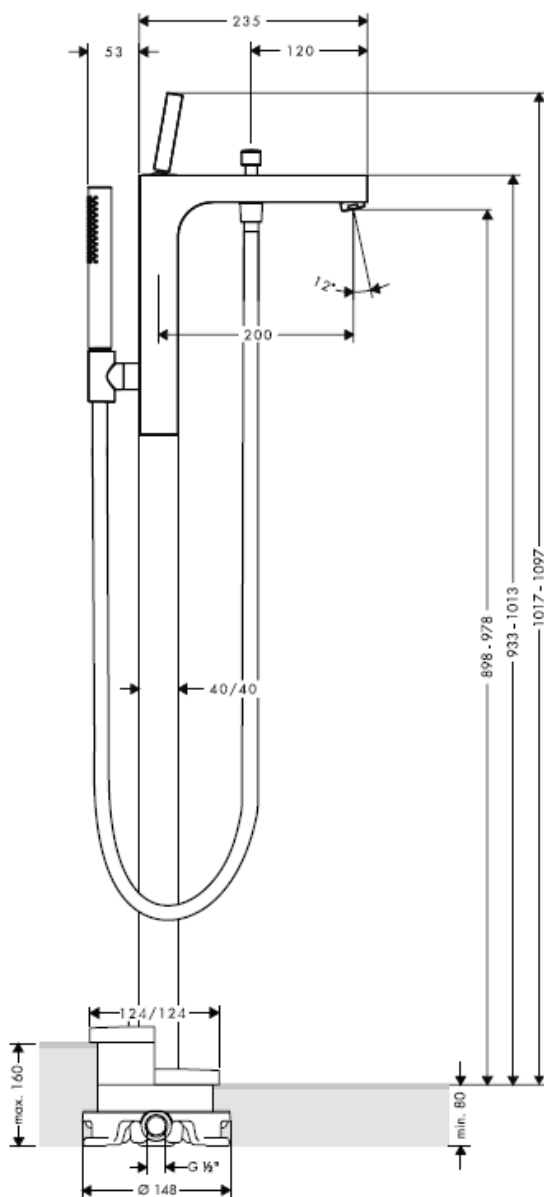

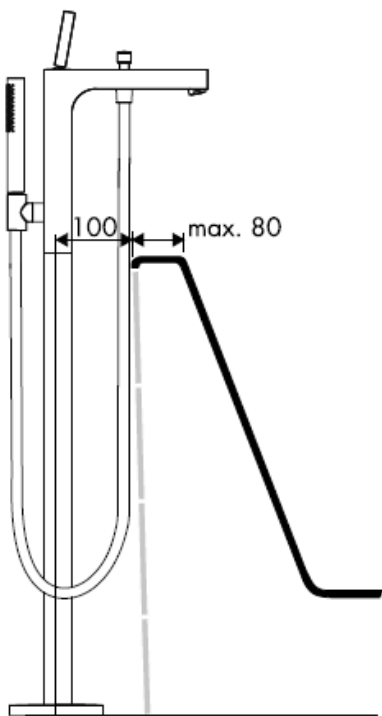

¡Atención! El grifo tiene que ser instalado, probado y testado, según las normas en vigor.

Starck 10452180

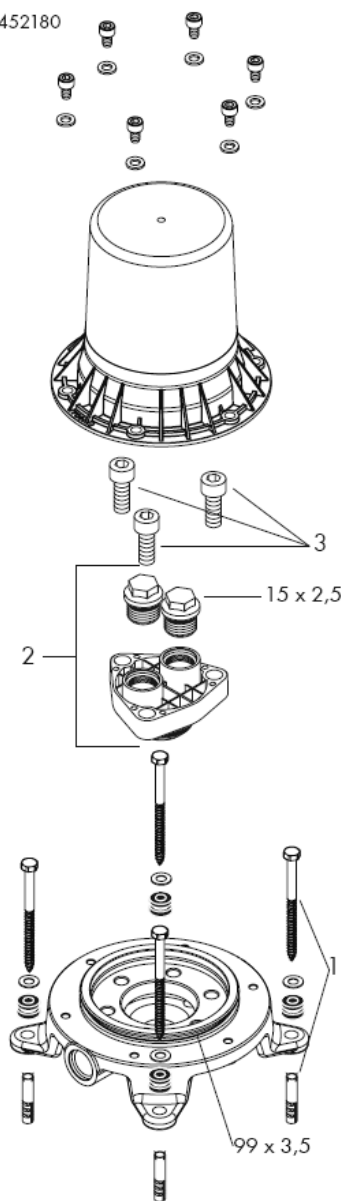

Montreux 16549180

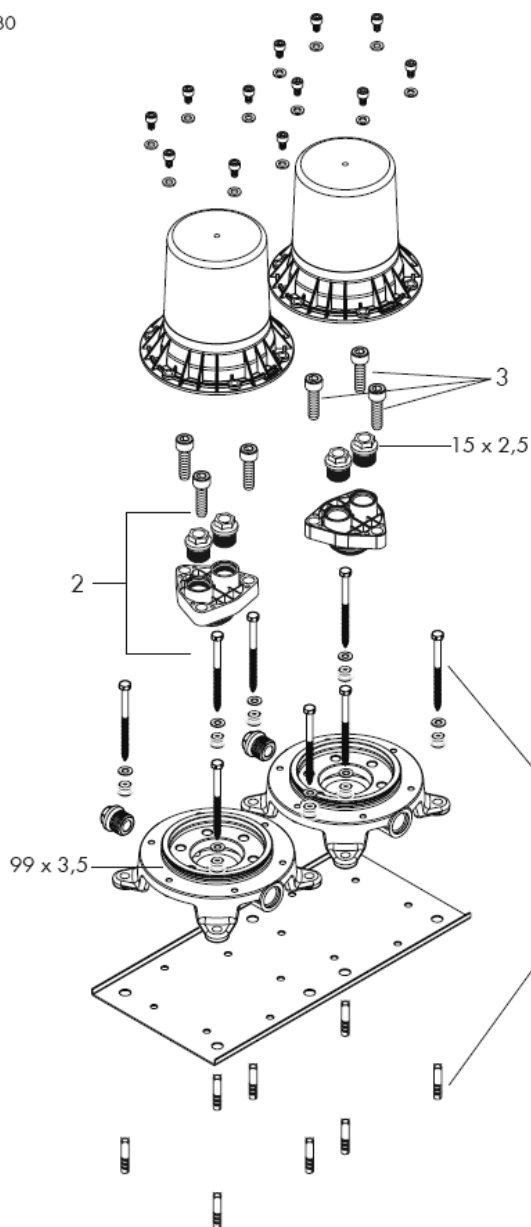

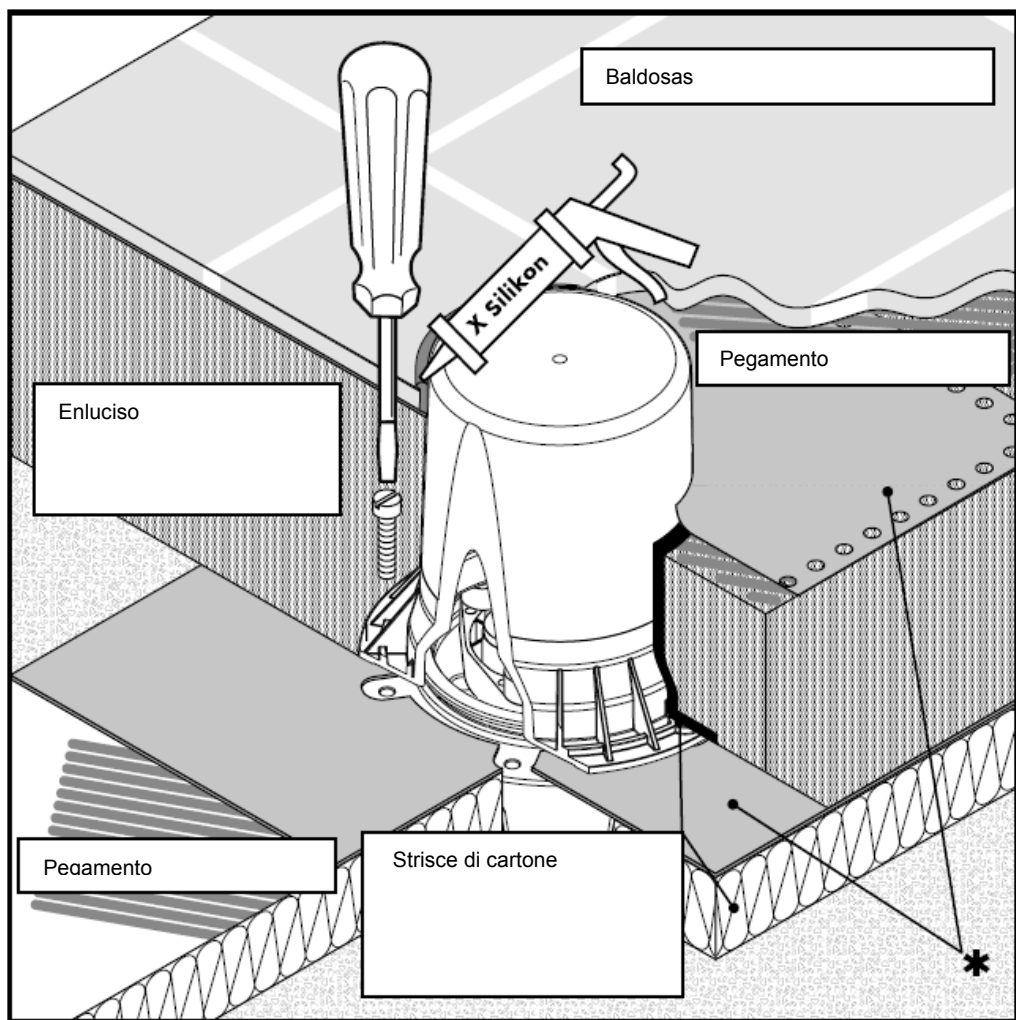

* tira impermeabilizante opzionale

X Silicona (¡libre de ácido acético!)

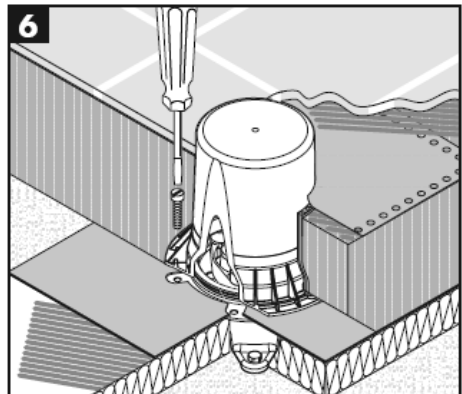
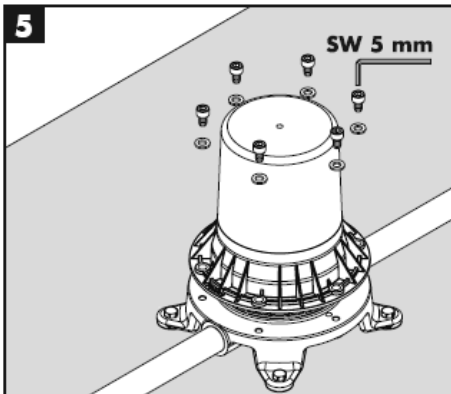
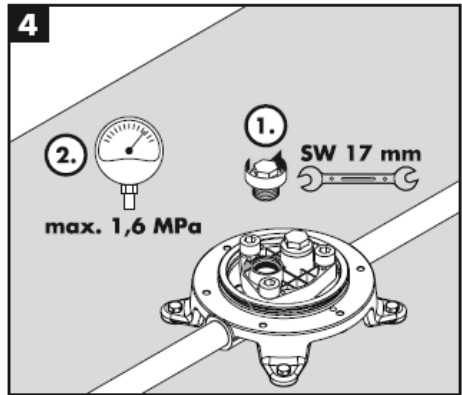
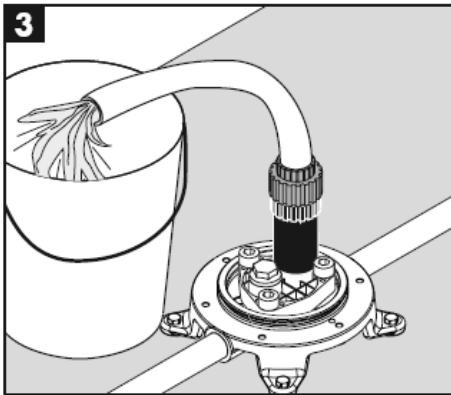
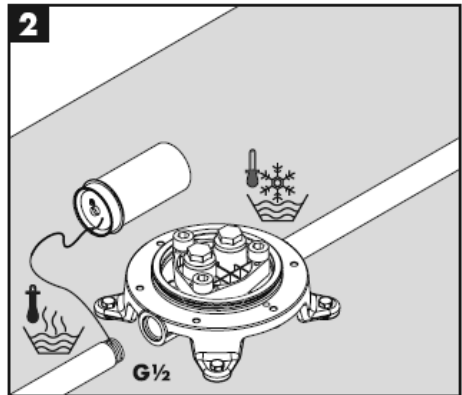
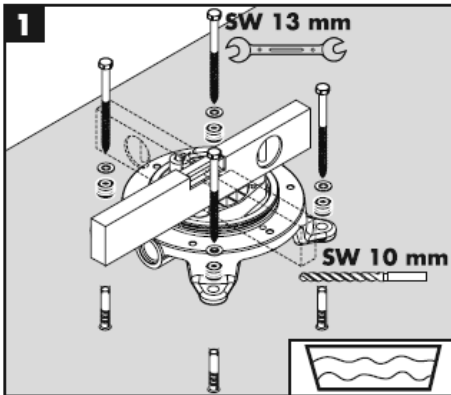

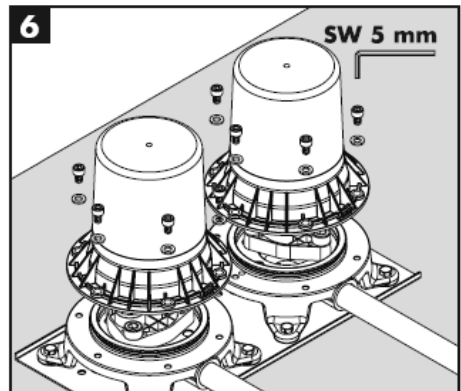
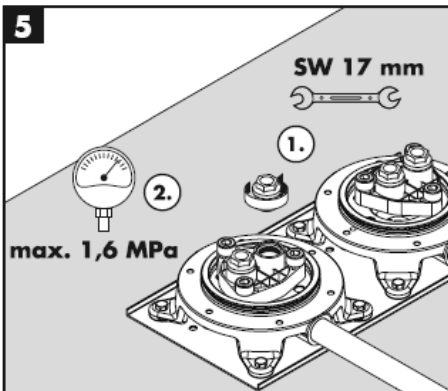
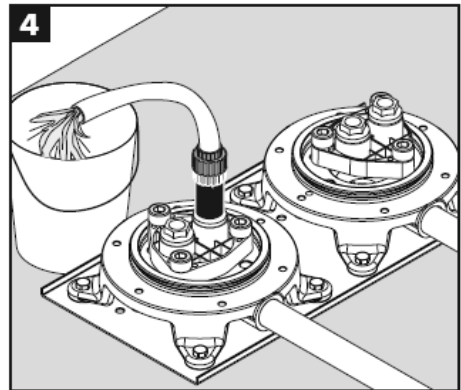
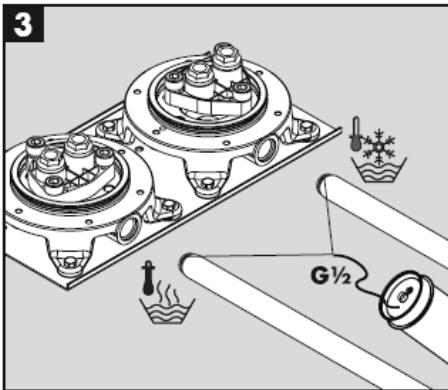
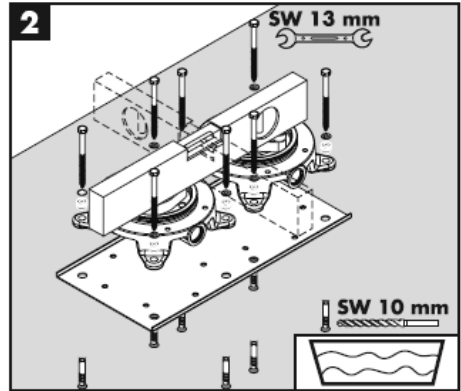
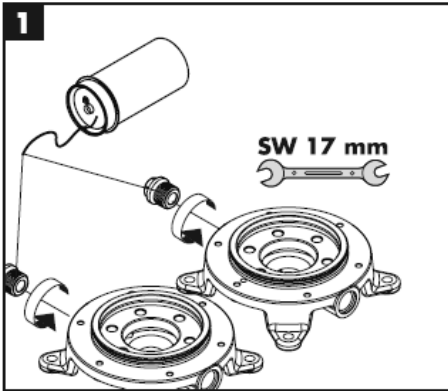

Montaje

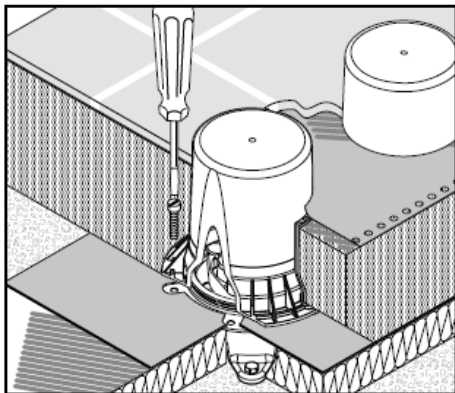

Español

Datos técnicos

Presión en servicio: max. 1 MPa
Presión recomendada en servicio: 0,1 – 0,5 MPa
Presión de prueba: 1,6 MPa
(1 MPa = 10 bar = 147 PSI)
Temperatura del agua caliente: max. 80° C
Temp. recomendada del agua caliente: 65° C

Repuestos ver página 10 – 11

Set de fijación 96260000
Junta 96459000
Tornillo de cabeza cilíndrica M 10 x 35 97670000

Opcional

* Tira impermeabilizante 96441000
(no incluido en el suministro)

Marca de verificación

	DVGW	P-IX	SVGW	ACS	NF	WRAS	KIWA
10452180				x		X	
16549180		PA-IX 18729/ICB					

hansgrohe

Handleiding

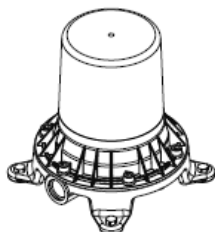

Starck
10452180

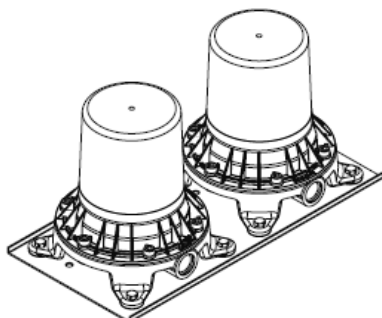

Montreux
16549180

AXOR[®]

hansgrohe

Starck 10458XXX

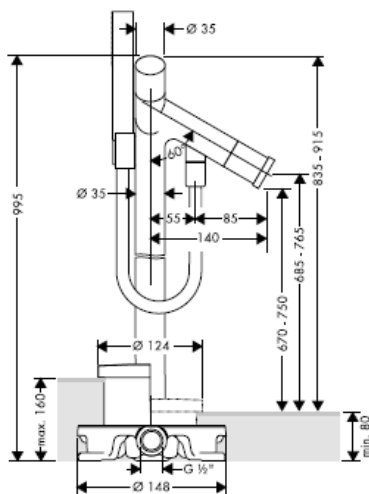

Starck 10060XXX

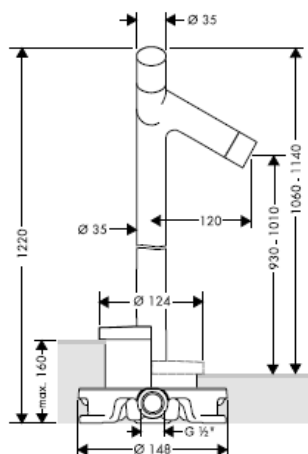

Starck 10456XXX

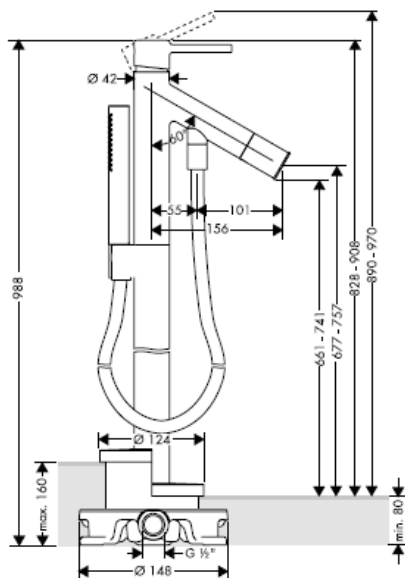

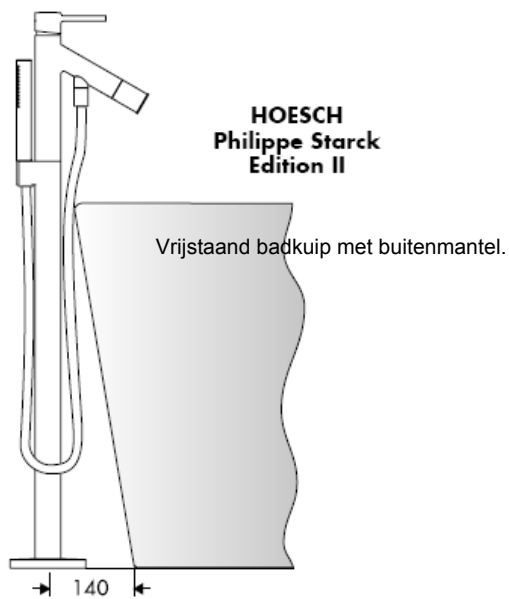
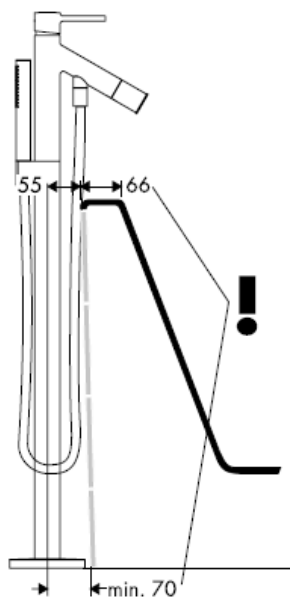
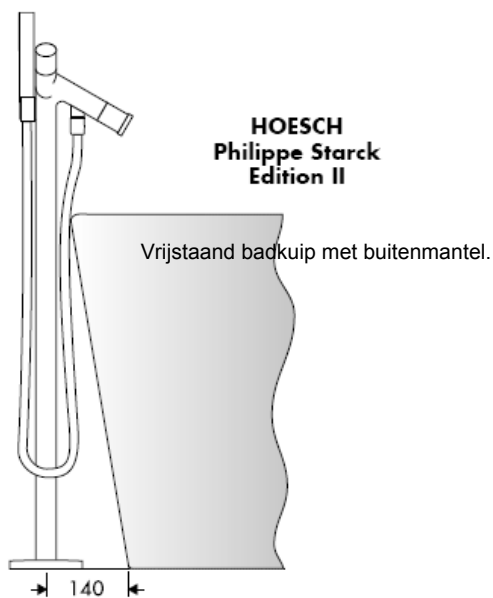

Starck X 10406000

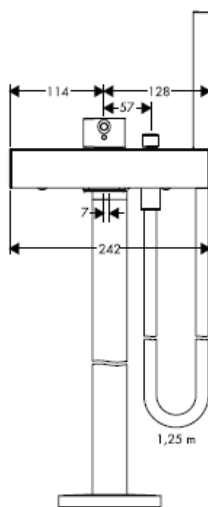
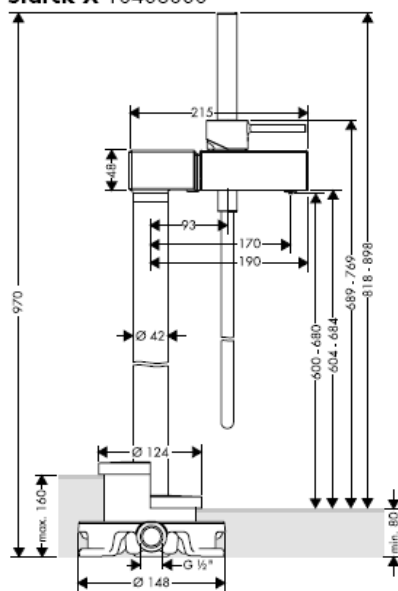

Montreux 16547XXX

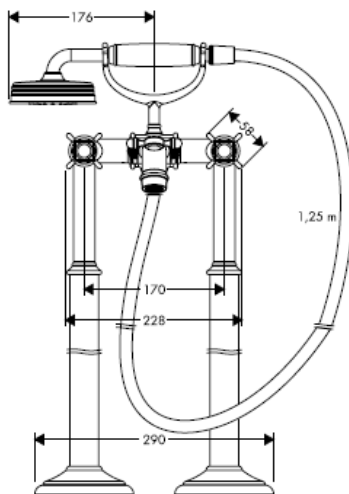
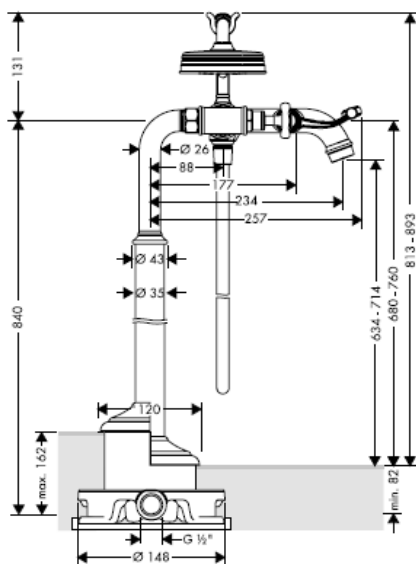

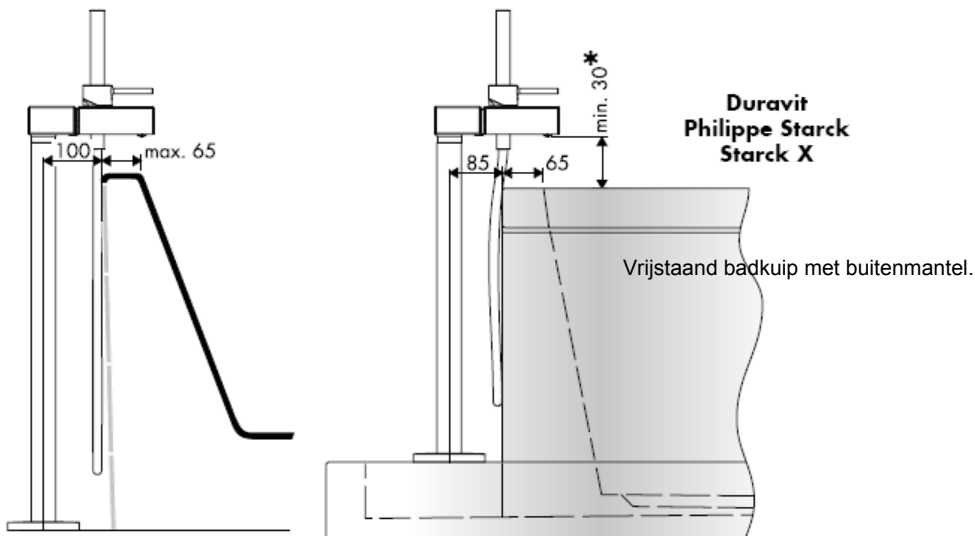

* < 30 min = Verlengstuk 60 mm (Artikelnummer 97686000)



Massaud 18450000

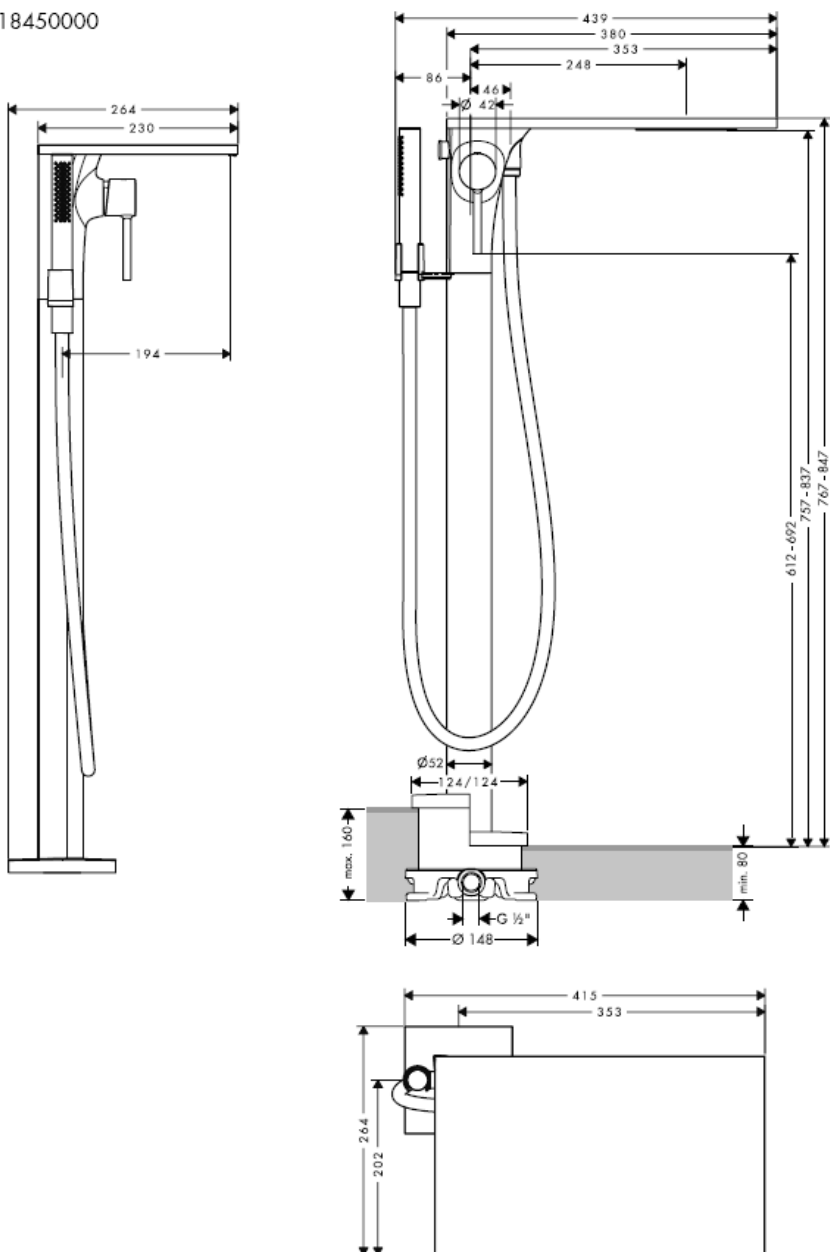

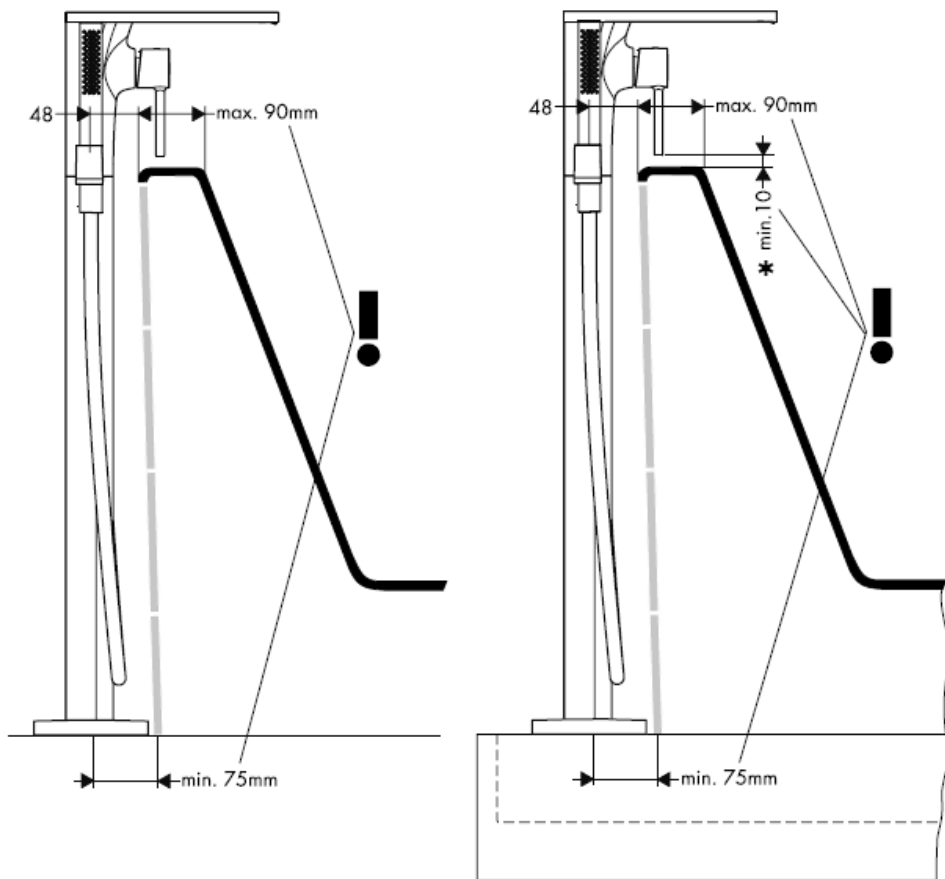

* < 10 min = Verlengstuk 60 mm (Artikelnummer 97686000)

Citterio 39451000

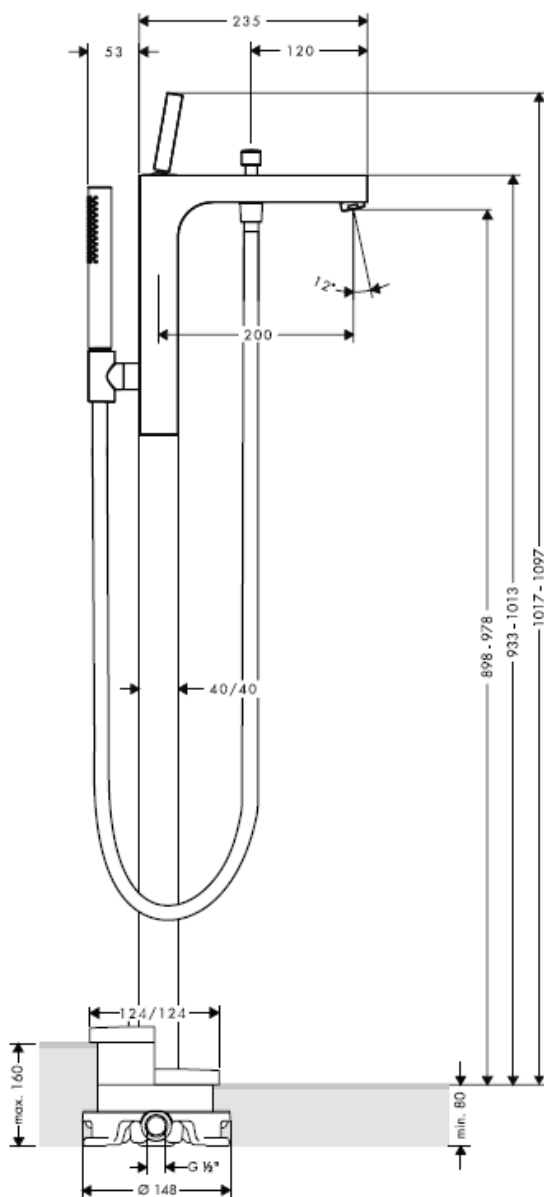

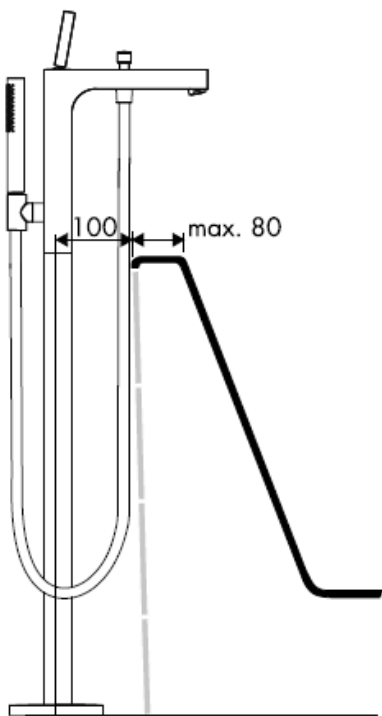

Attentie! Leidingen doorspoelen volgens Norm.
De mengkraan vervolgens monteren en
controleren!

Starck 10452180

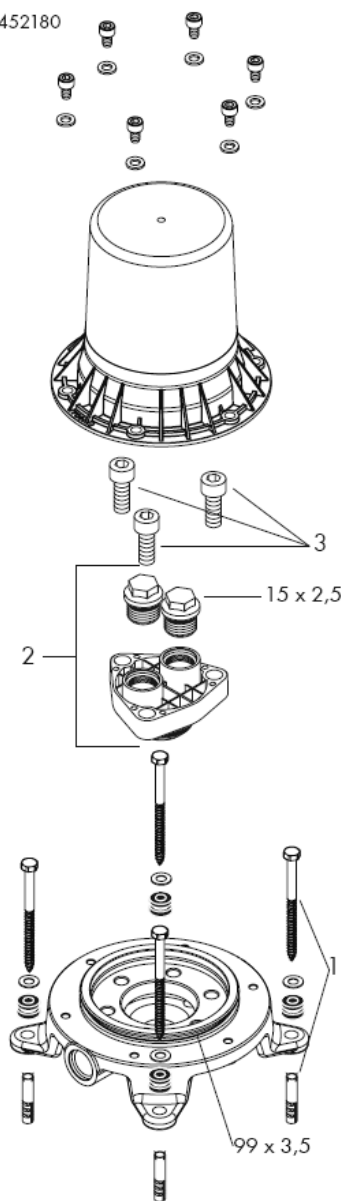

Montreux 16549180

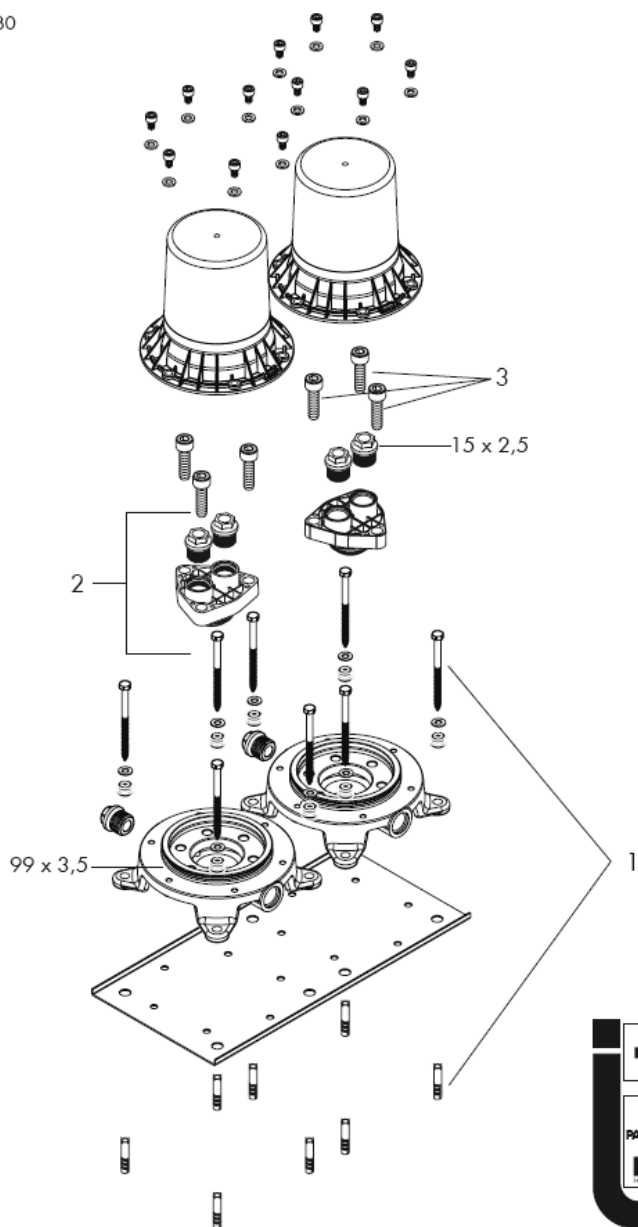

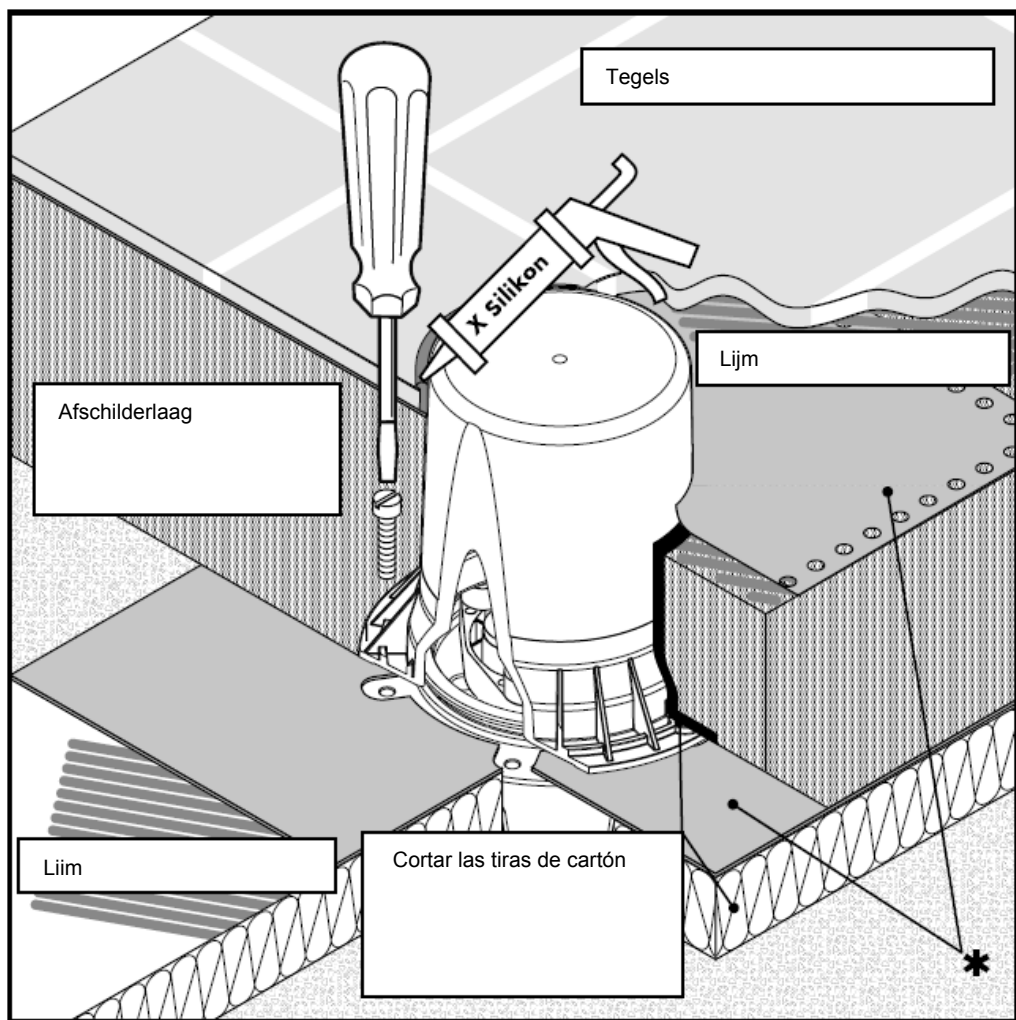

* optioneel verkrijgbare dichtmanchet

X Silicone (azijnzuurvrij!)

Montage

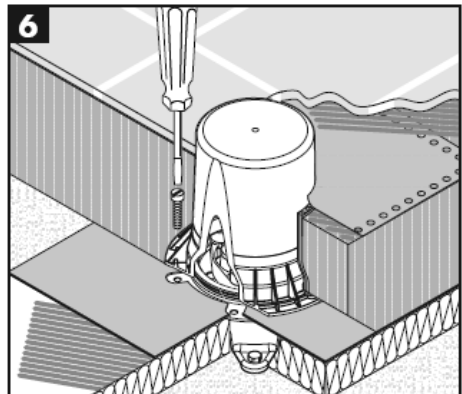
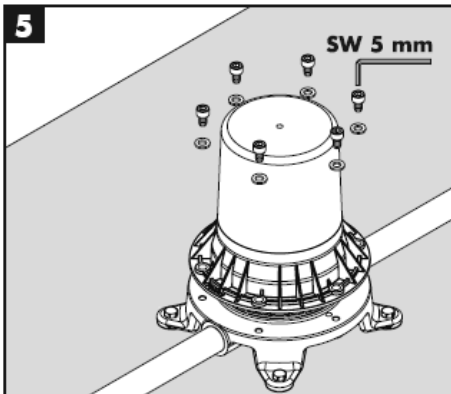
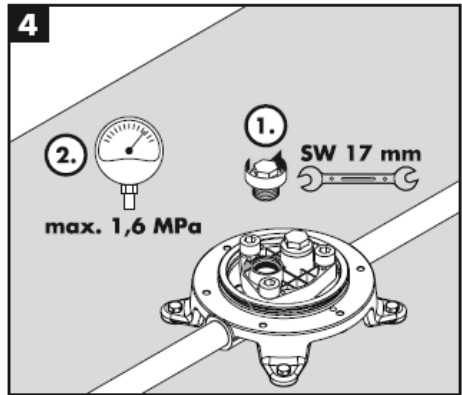
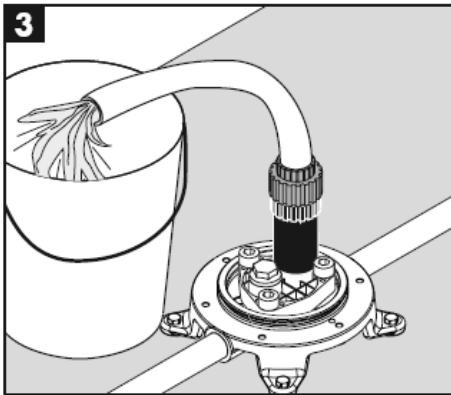
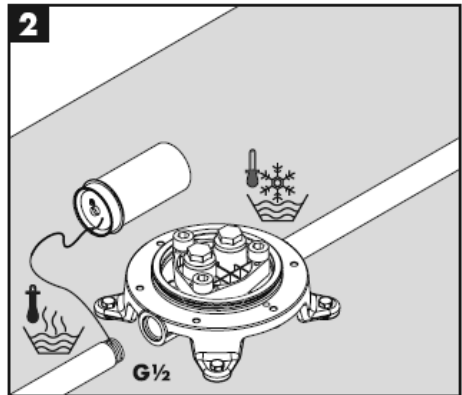
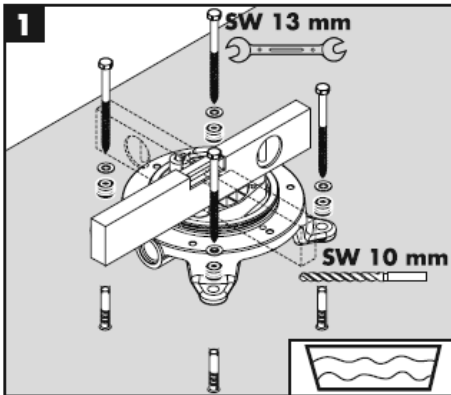

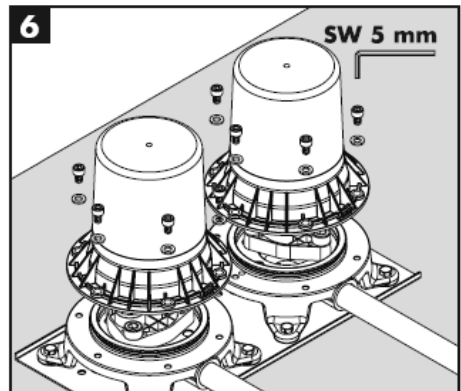
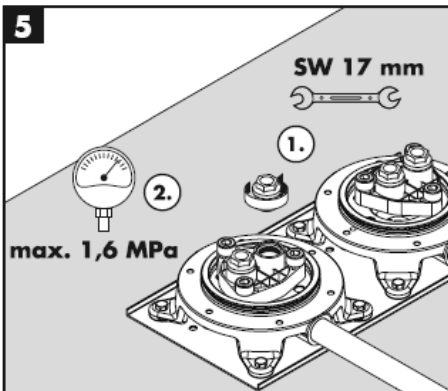
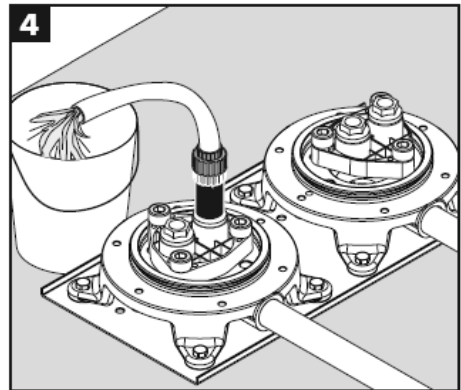
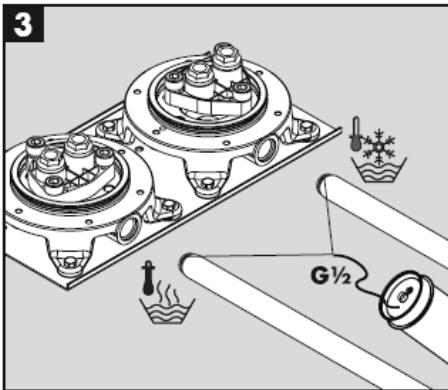
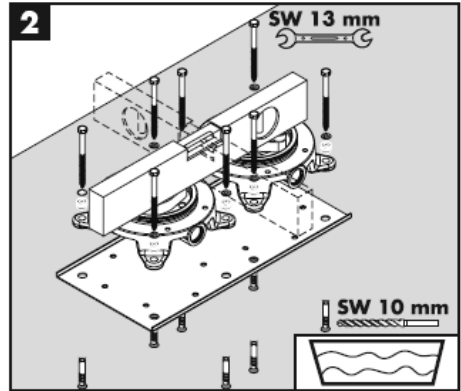
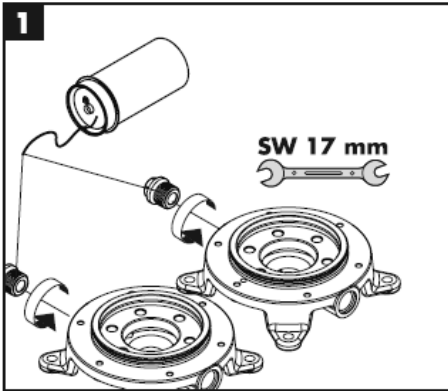

Montage

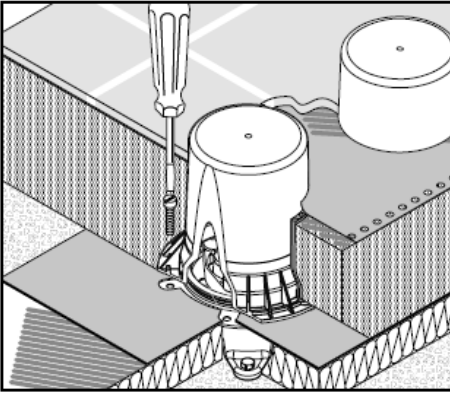

Nederlands

Technische gegevens

Werkdruk: max. max. 1 MPa
Aanbevolen werkdruk: 0,1 – 0,5 MPa
Getest bij: 1,6 MPa
(1 MPa = 10 bar = 147 PSI)
Temperatuur warm water: max. 80° C
Aanbevolen warm water temp.: 65° C

Service onderdelen zie blz. 10 – 11

bevestigingsmateriaal 96260000
dichtingsset 96459000
cilinderkopschroef M 10 x 35 97670000

Toebehoren

* dichtmanchet 96441000
(behoort niet tot het leveringspakket)

Keurmerk

	DVGW	P-IX	SVGW	ACS	NF	WRAS	KIWA
10452180				x		X	
16549180		PA-IX 18729/ICB					

hansgrohe

Monteringsvejledning

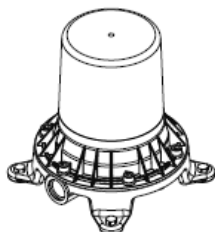

Starck
10452180

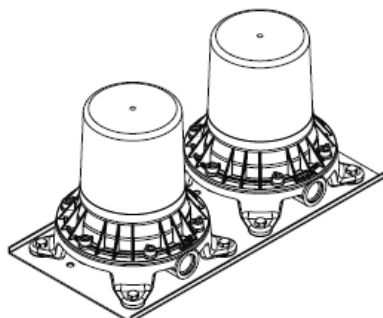

Montreux
16549180

AXOR[®]

hansgrohe

Starck 10458XXX

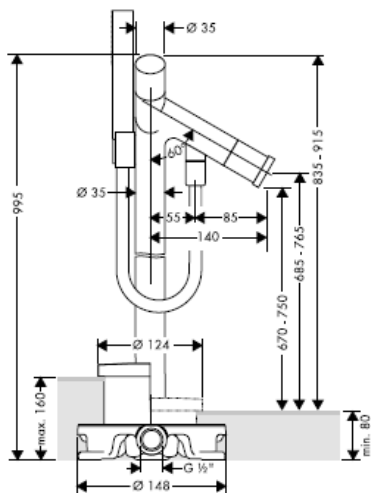

Starck 10060XXX

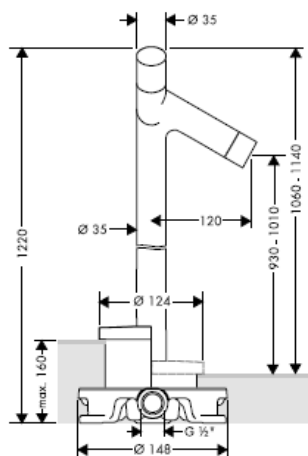

Starck 10456XXX

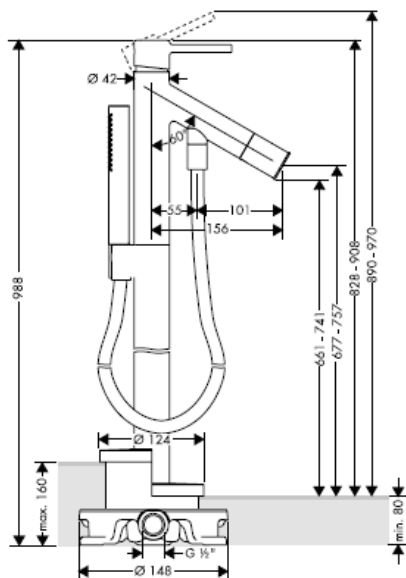

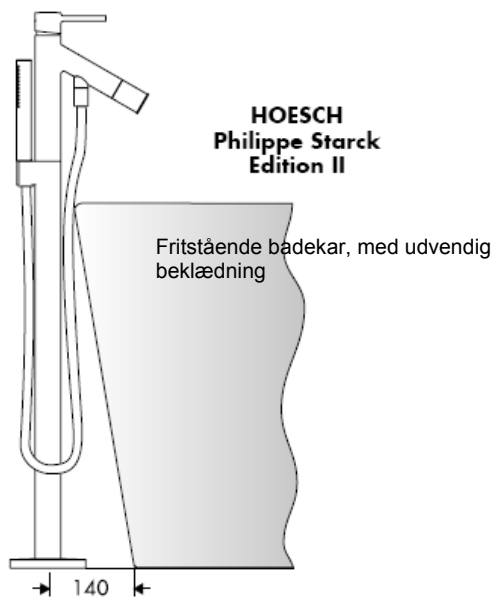
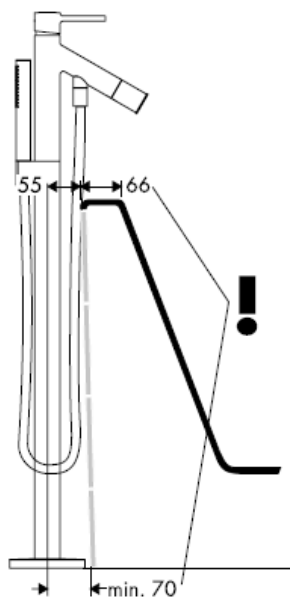
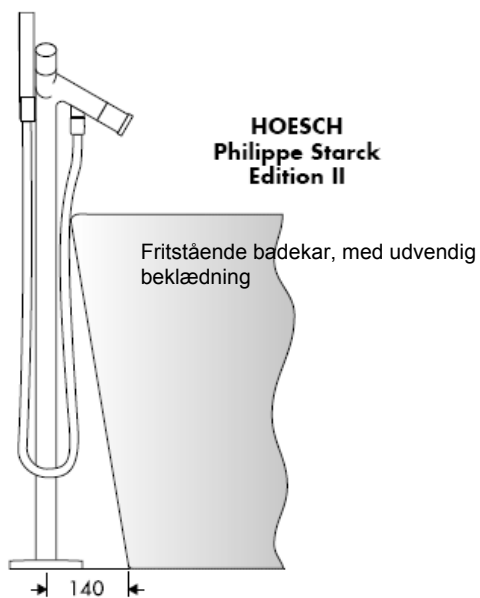

Starck X 10406000

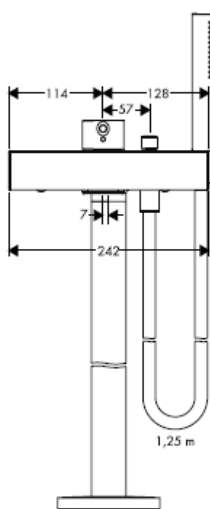
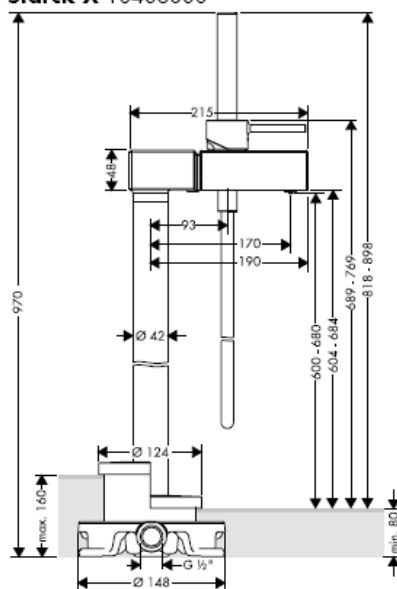

Montreux 16547XXX

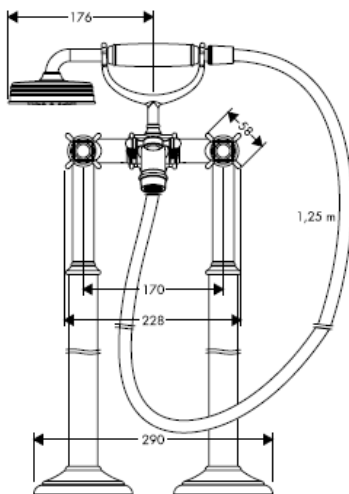
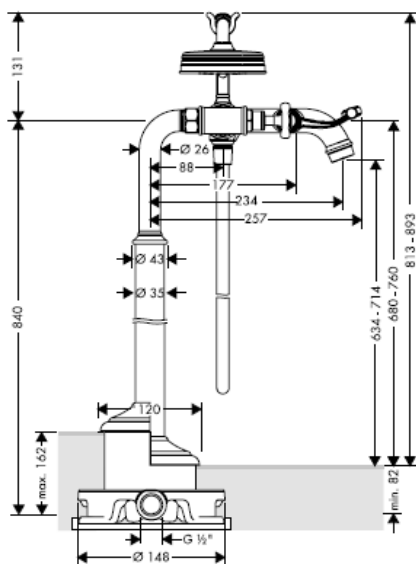

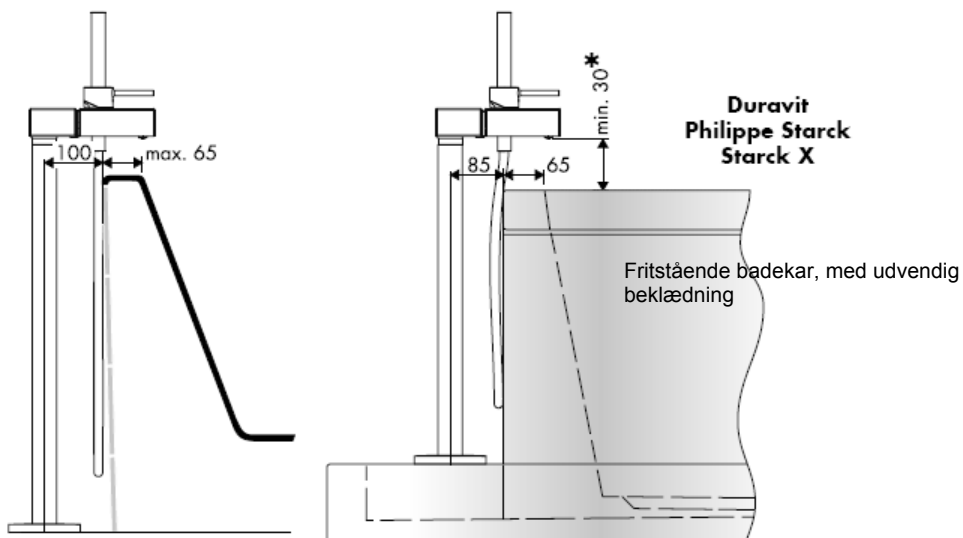

* < 30 min = Forlængersæt 60 mm (art. nr. 97686000)

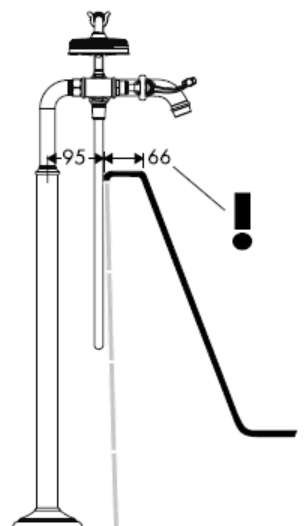

Massaud 18450000

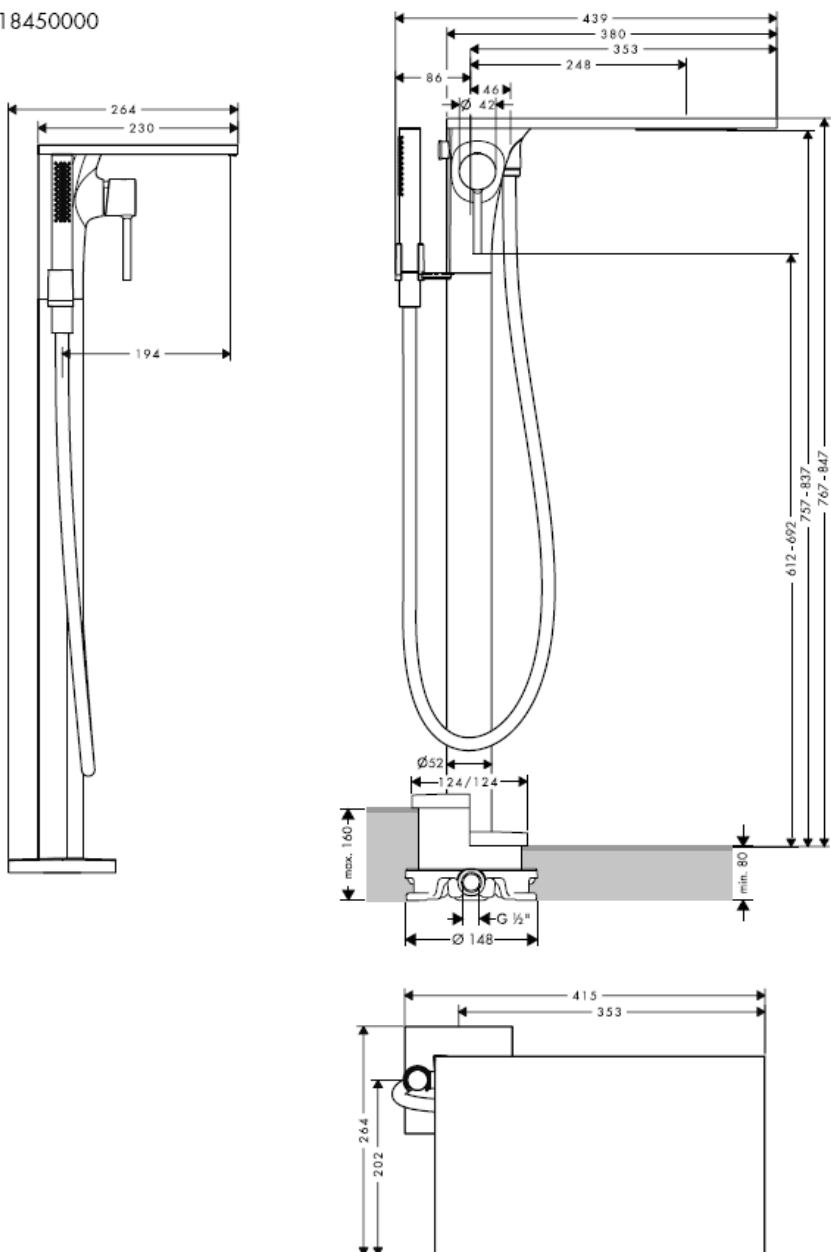

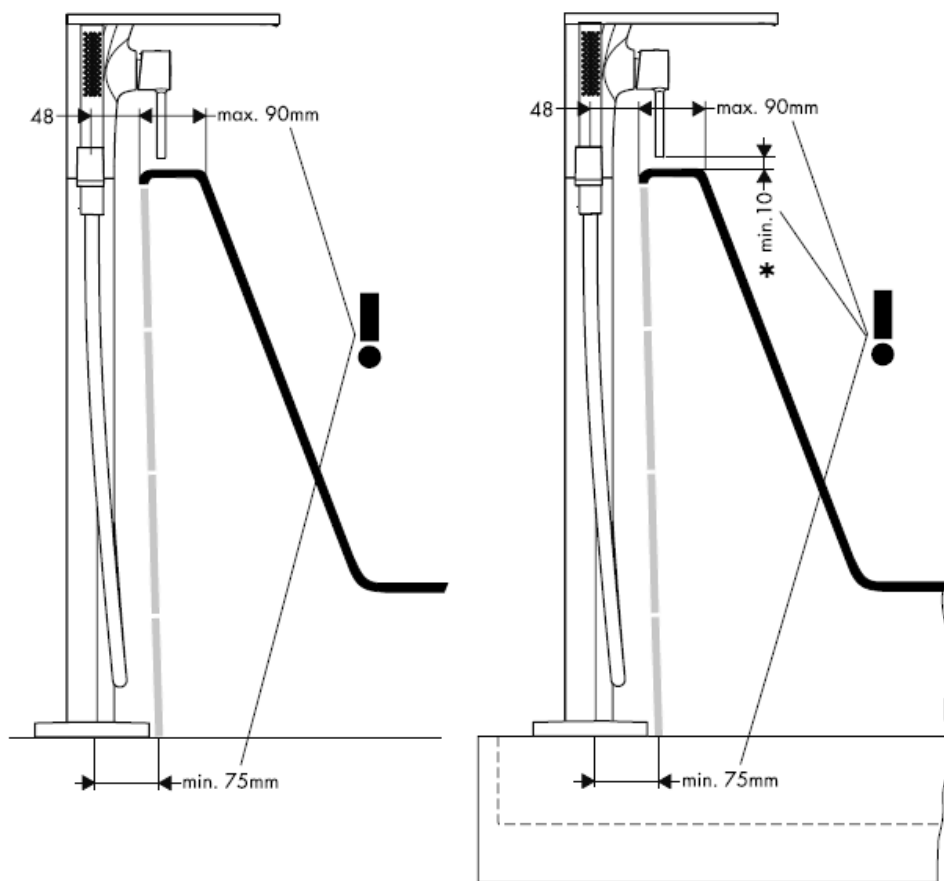

* < 10 min = Forlængersæt 60 mm (art. nr. 97686000)

Citterio 39451000

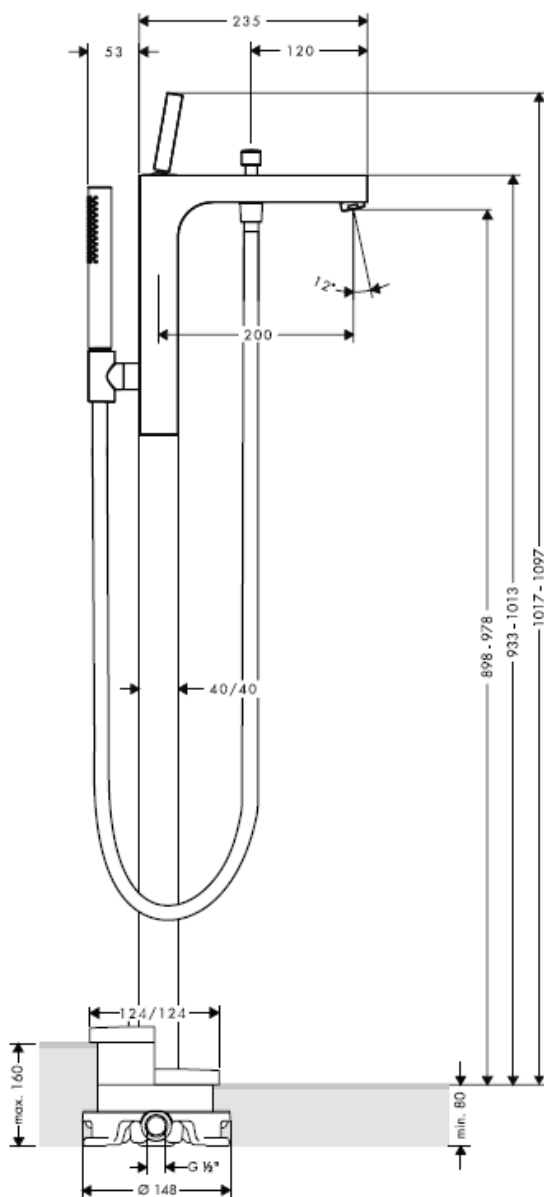

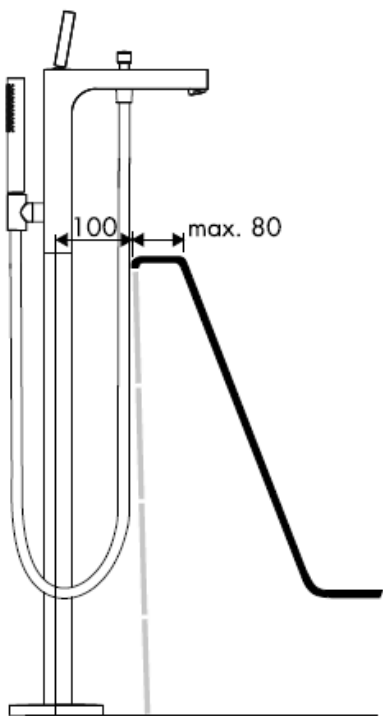

Advarsel! Ifølge gældende regler, skal armaturet monteres, skylles igennem og afprøves.

Starck 10452180

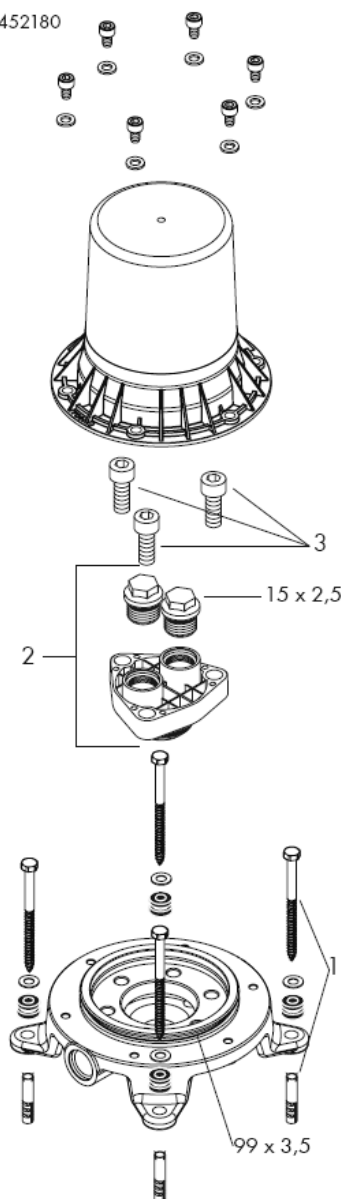

Montreux 16549180

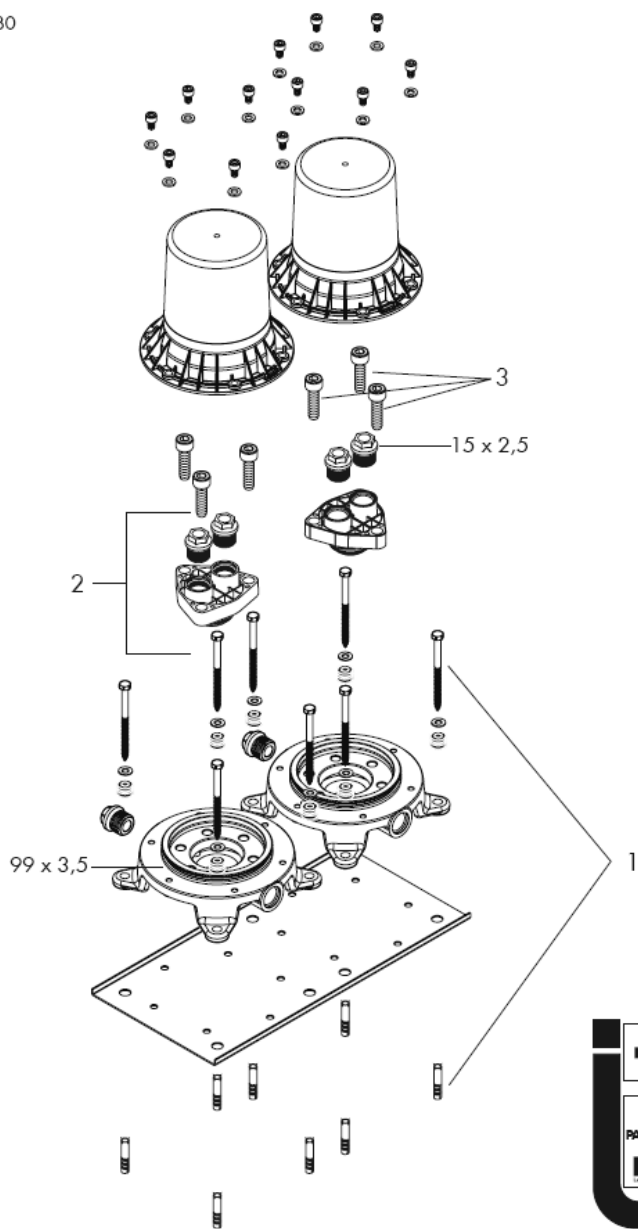

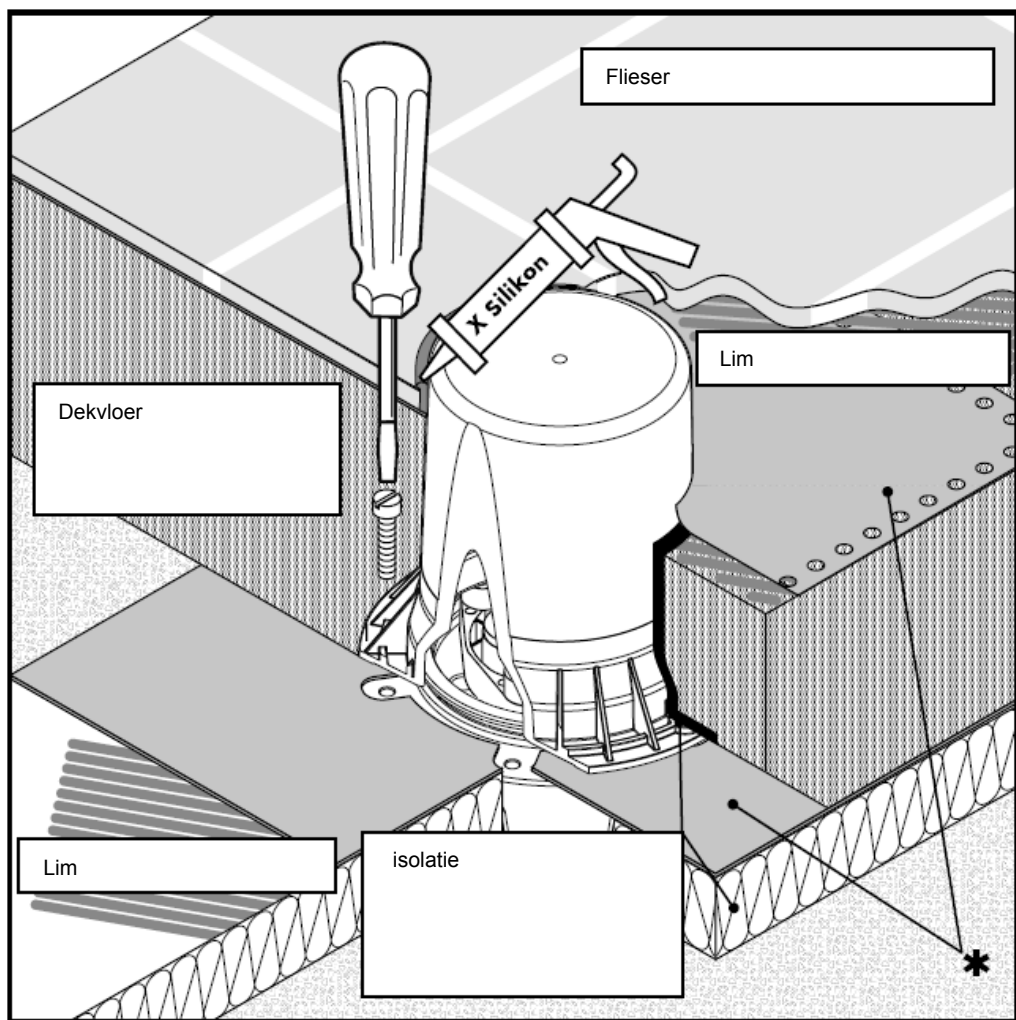

* efter ønske fås en tætningsmanchet

X Silikone (eddikesyre-fri)

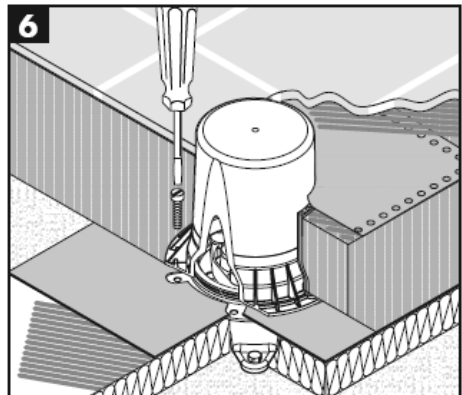
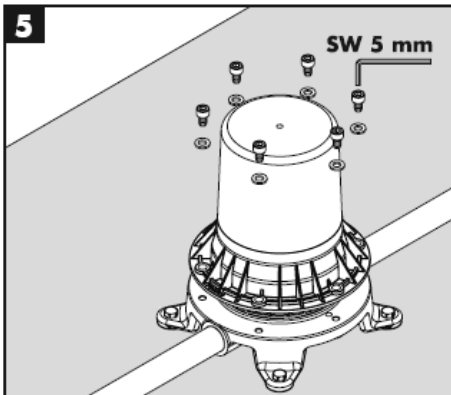
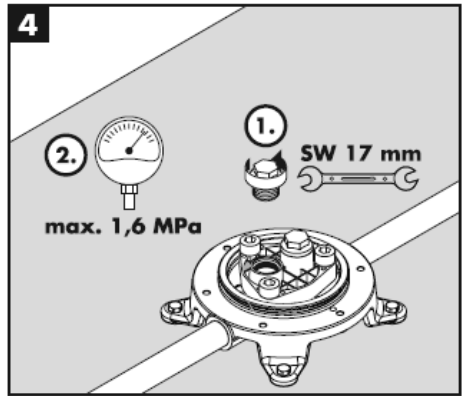
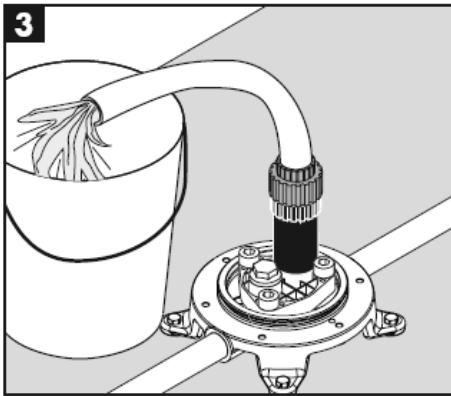
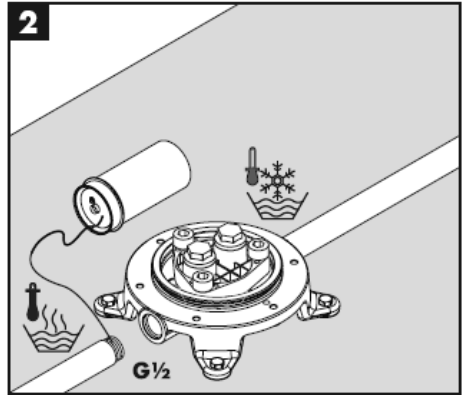
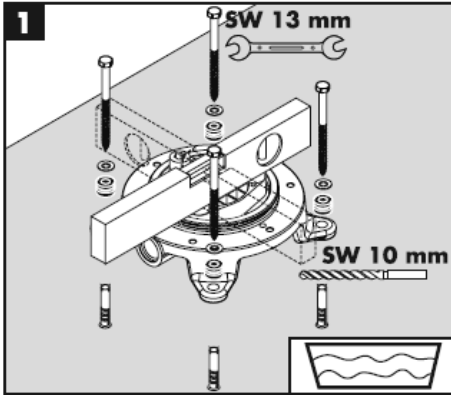

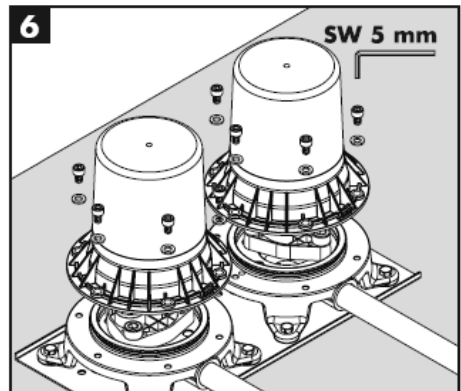
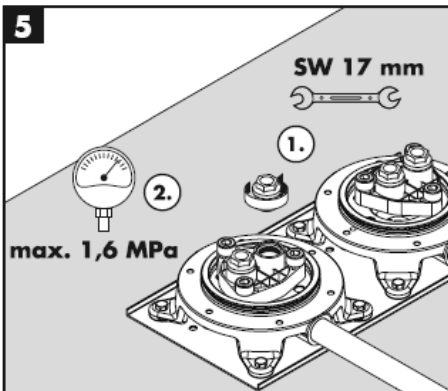
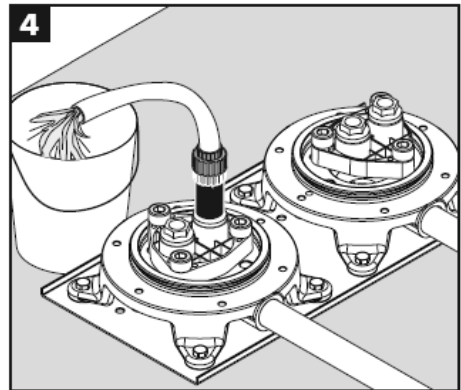
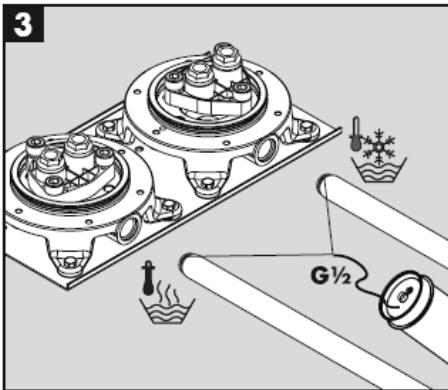
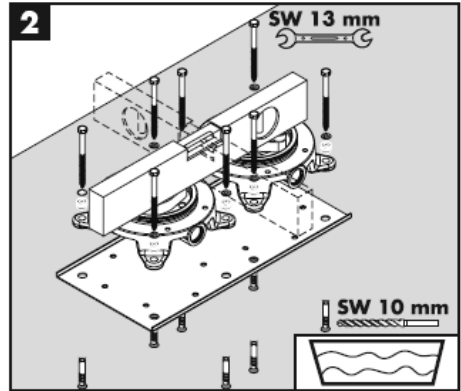
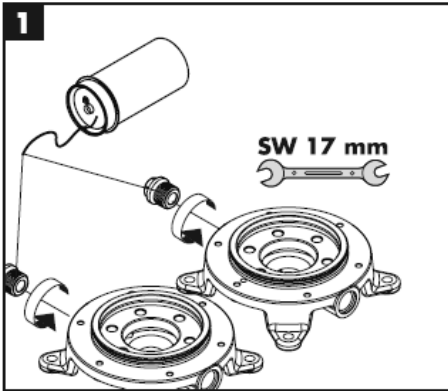

Montering

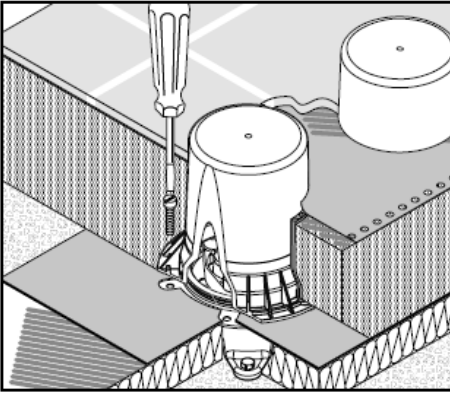

Dansk

Tekniske data

Driftstryk:	max. 1 MPa
Anbefalet driftstryk:	0,1 – 0,5 MPa
Prøvetryk:	1,6 MPa
(1 MPa = 10 bar = 147 PSI)	
Varmtvandstemperatur:	max. 80° C
Anbefalet varmtvandstemperatur:	65° C

Reserve dele se s. 10 – 11

Befæstigelsesdele	96260000
Pakningssæt	96459000
Cylinderskrue M 10 x 35	97670000

Specialtilbehør

* tætningsmanchet (ikke med i leveringsomfang)	96441000
---	----------

Godkendelse

	DVGW	P-IX	SVGW	ACS	NF	WRAS	KIWA
10452180				x		X	
16549180		PA-IX 18729/ICB					

hansgrohe

Manual de Instalación

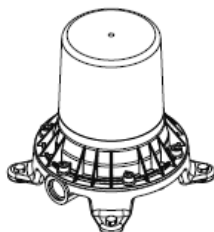

Starck
10452180

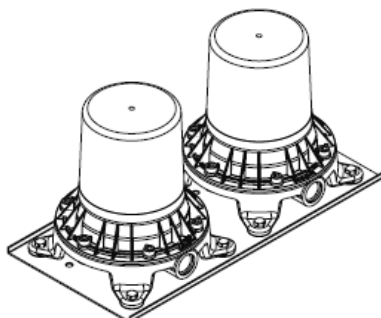

Montreux
16549180

AXOR[®]

hansgrohe

Starck 10458XXX

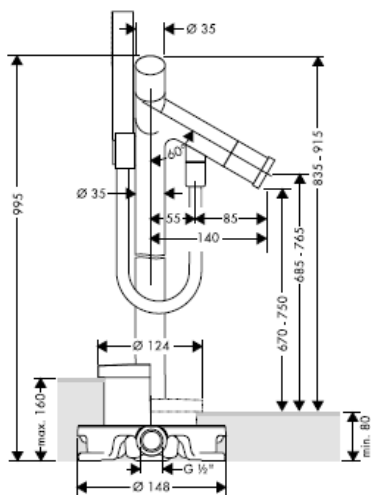

Starck 10060XXX

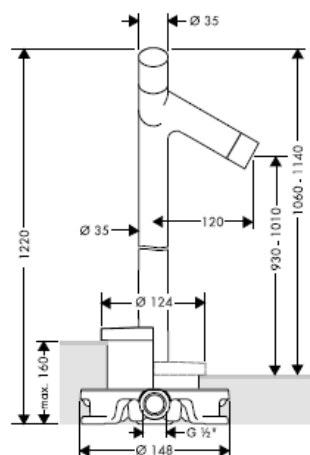

Starck 10456XXX

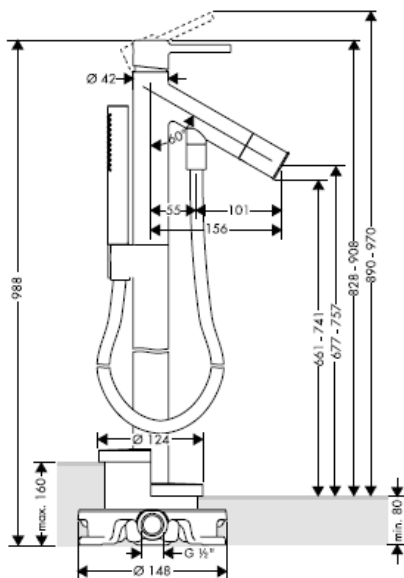

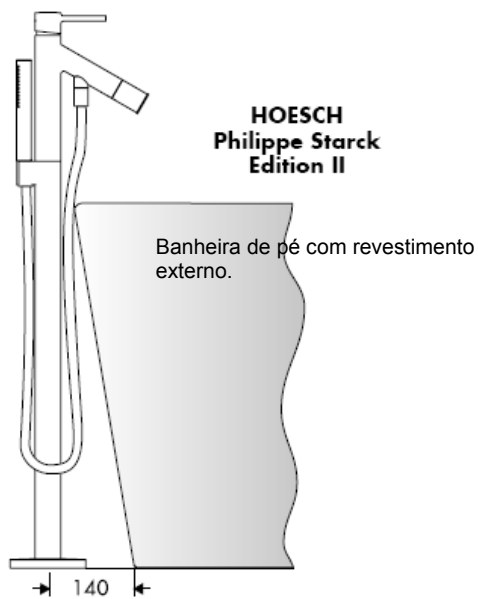
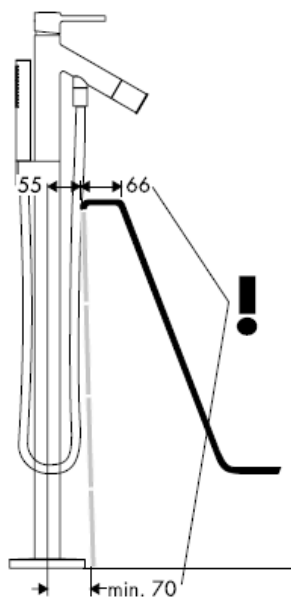
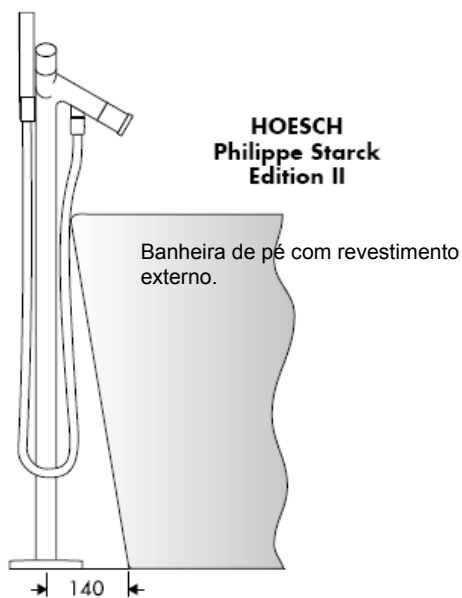

Starck X 10406000

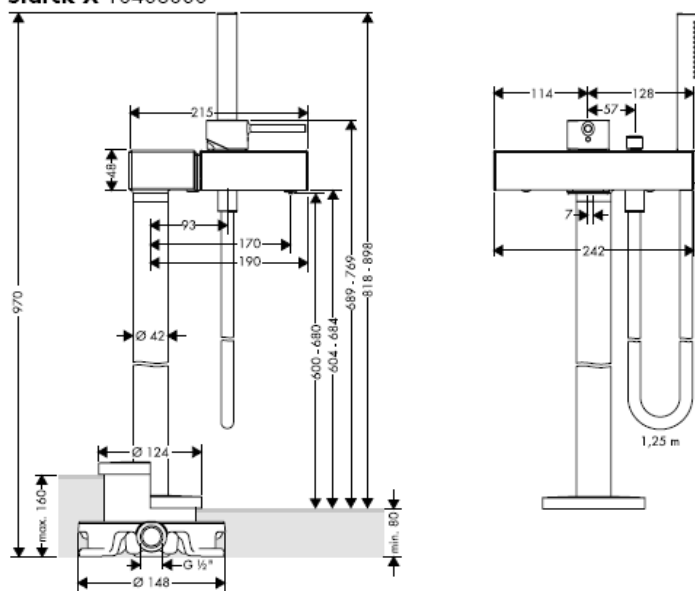

Montreux 16547XXX

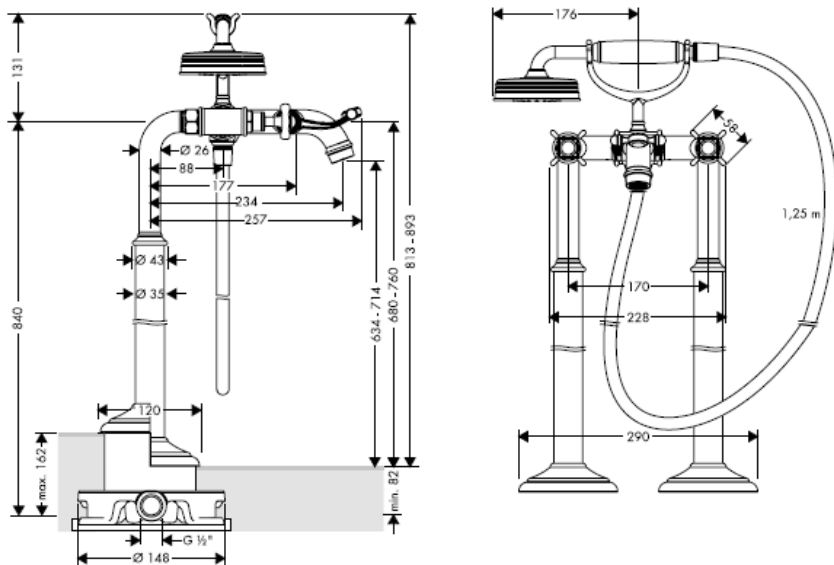

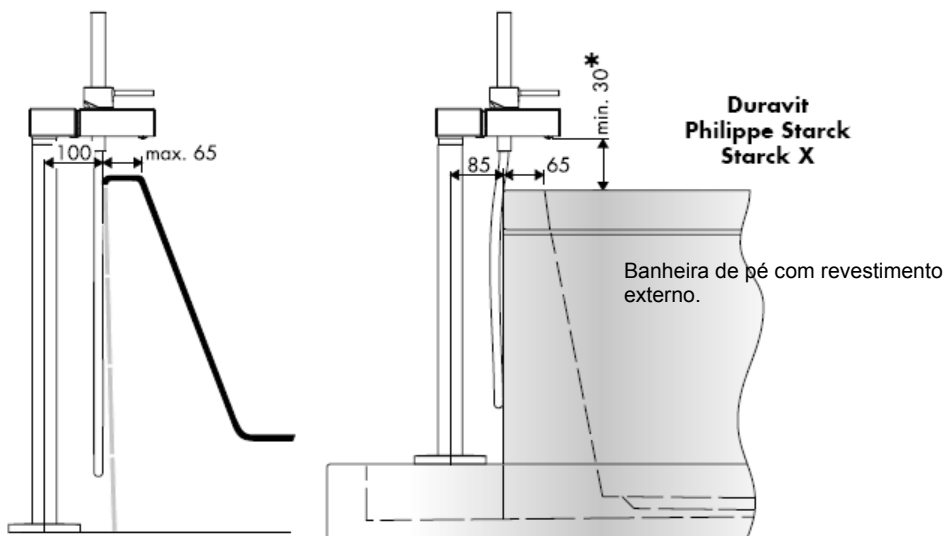

* < 30 min = Crescente 60 mm (referência 97686000)

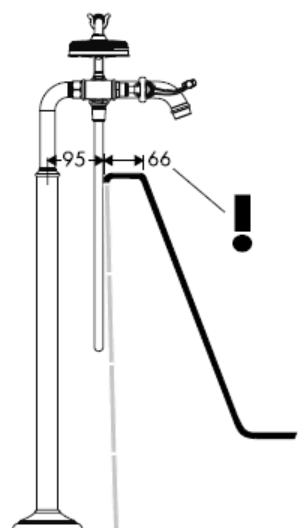

Massaud 18450000

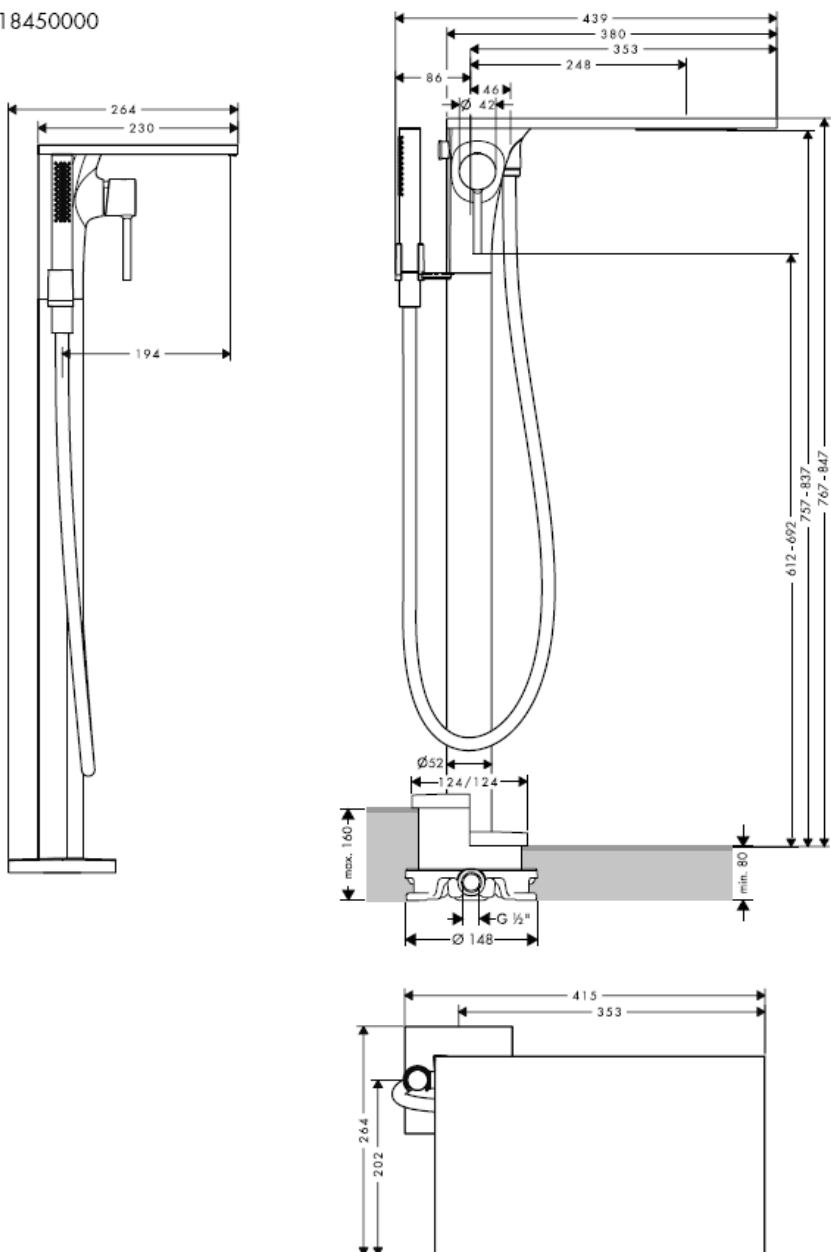

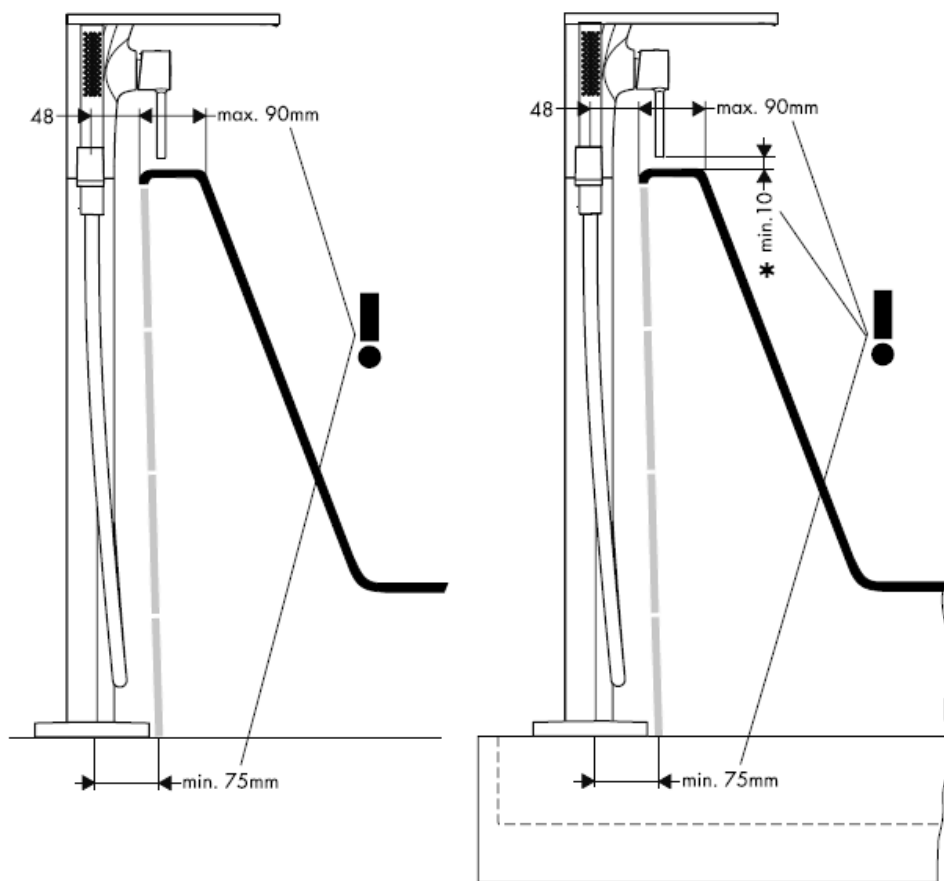

* < 10 min = Crescente 60 mm (referência 97686000)

Citterio 39451000

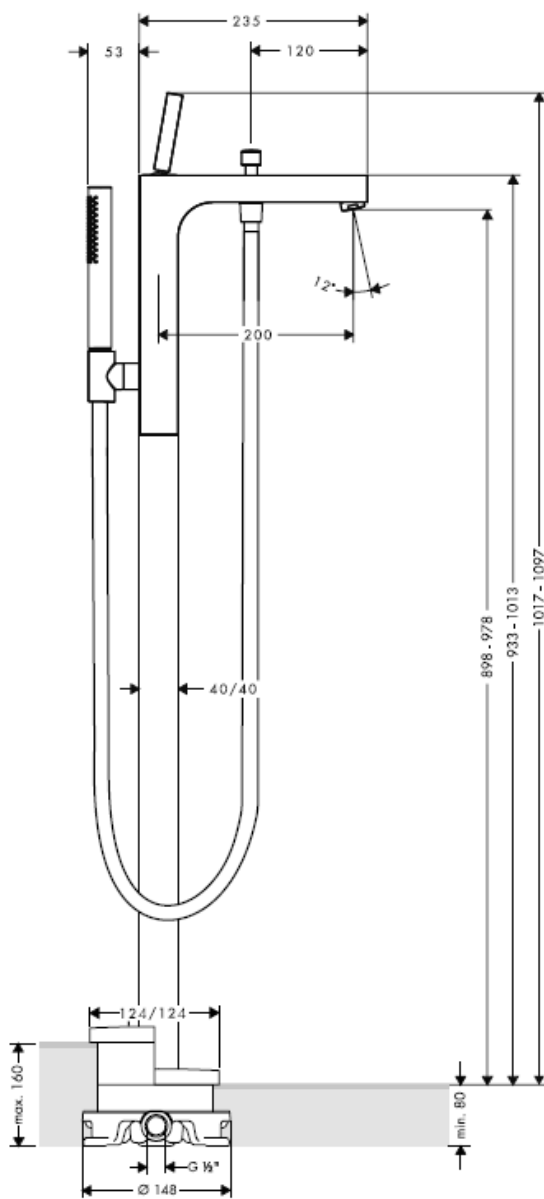

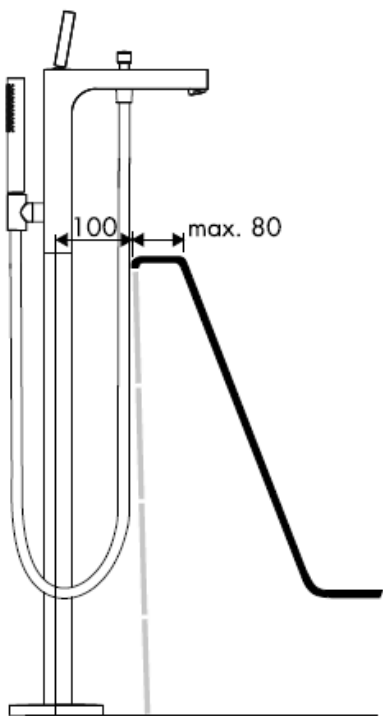

Atenção! A misturadora deve ser instalada, purgada e testada de acordo com as normas em vigor!

Starck 10452180

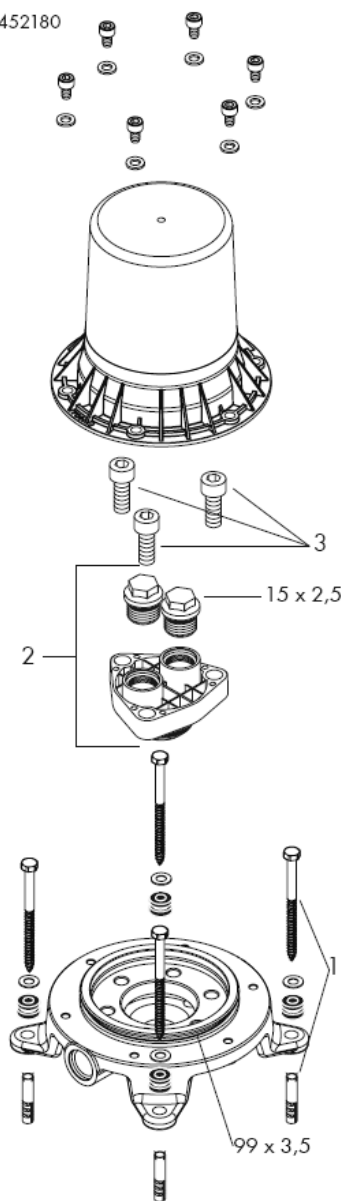

Montreux 16549180

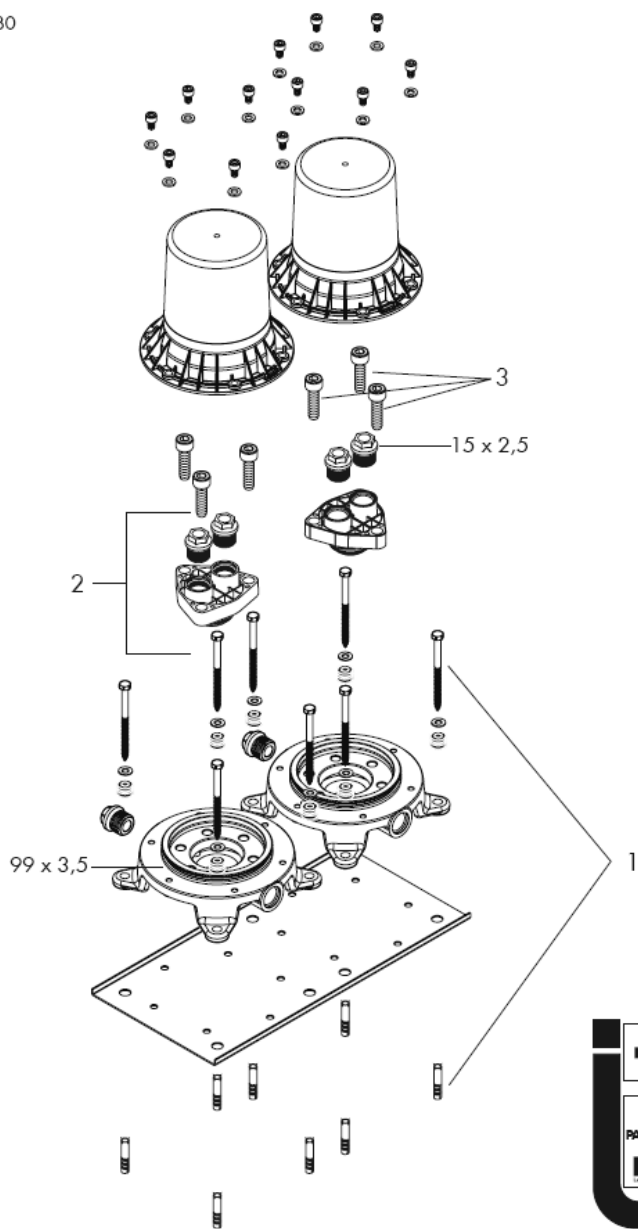

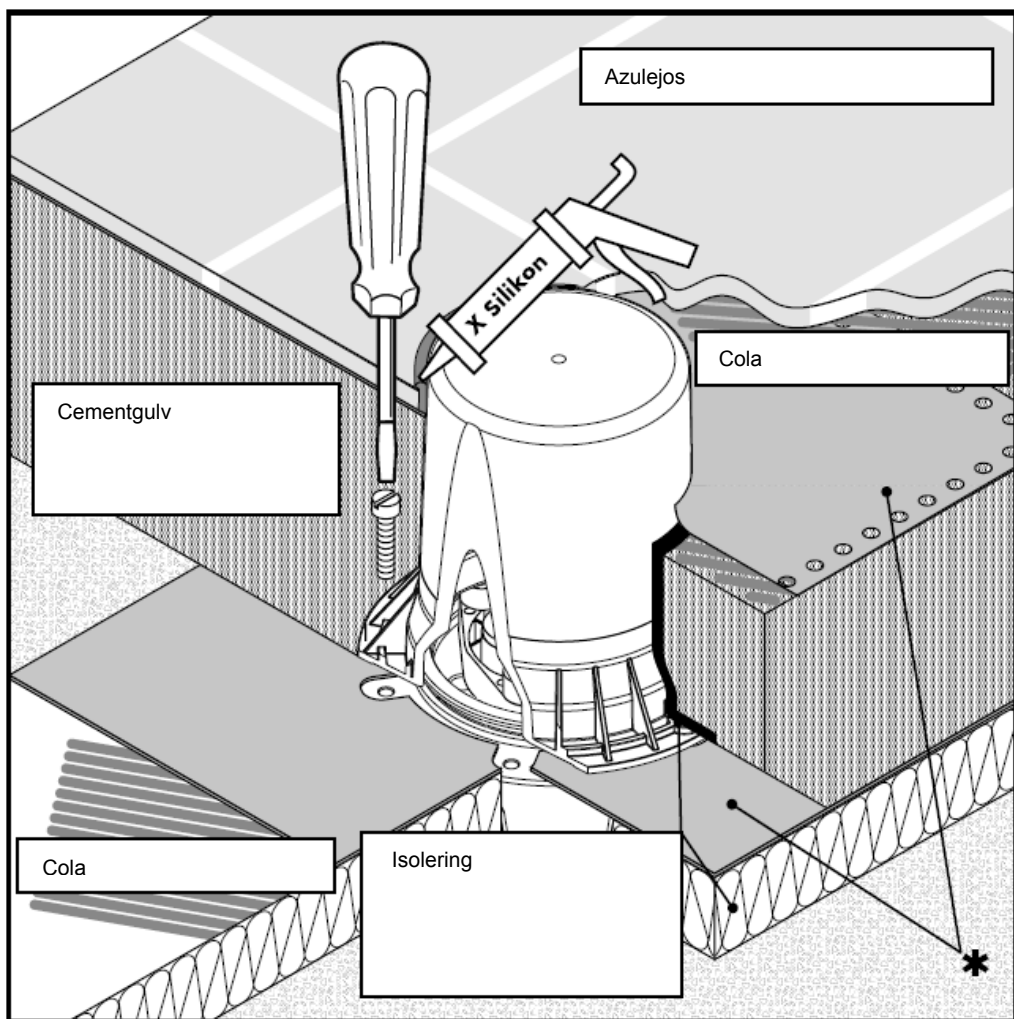

* se necessário, por favor encomende a
 alfarda de vedação correspondente

X Silicone (sem ácido acético)

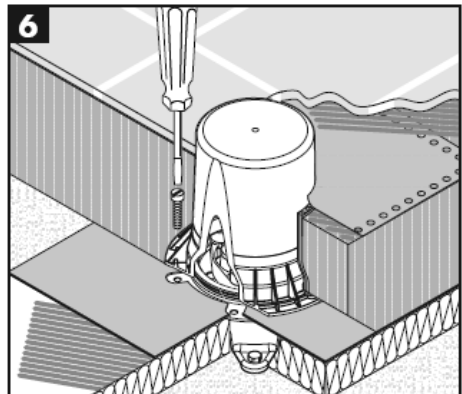
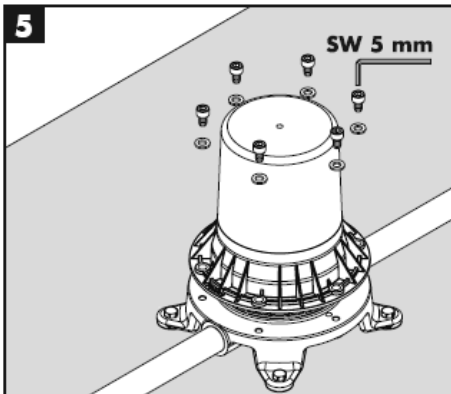
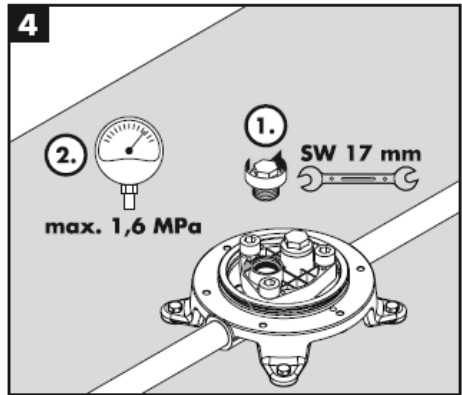
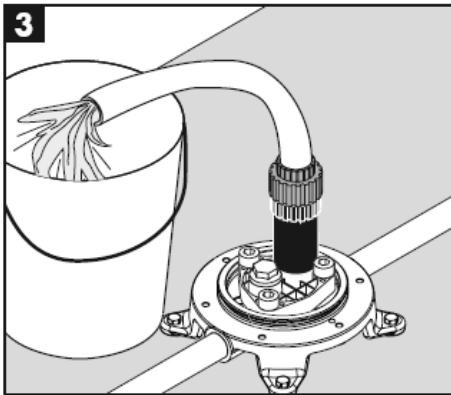
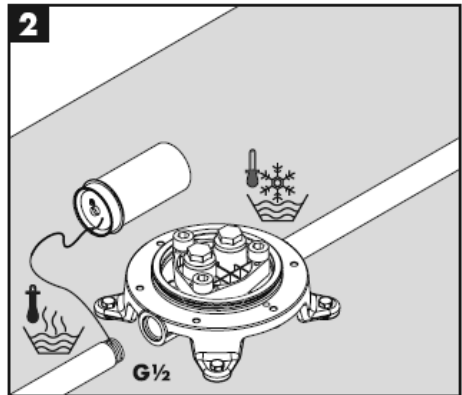
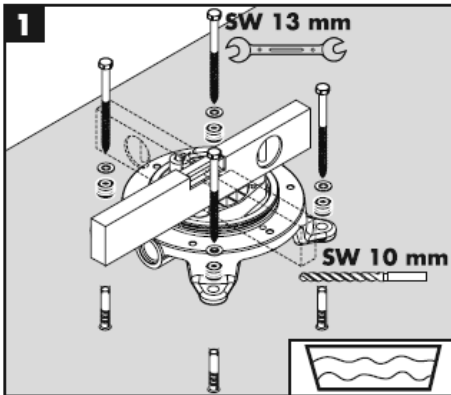

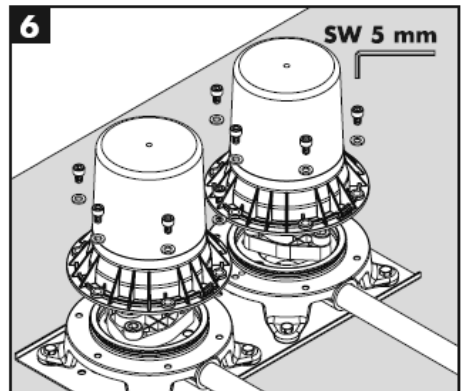
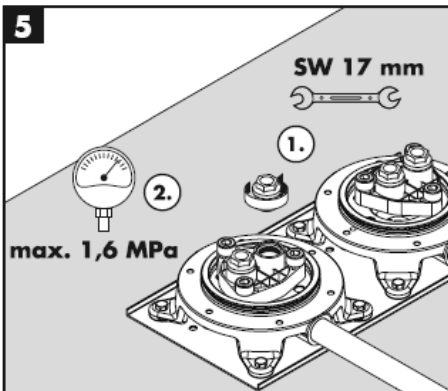
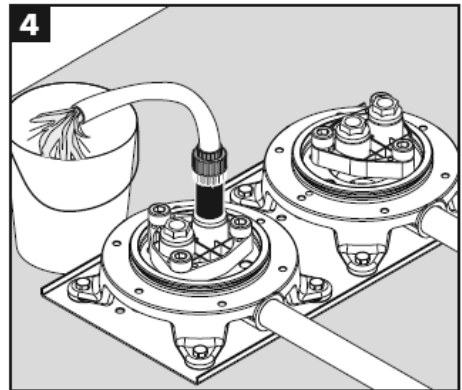
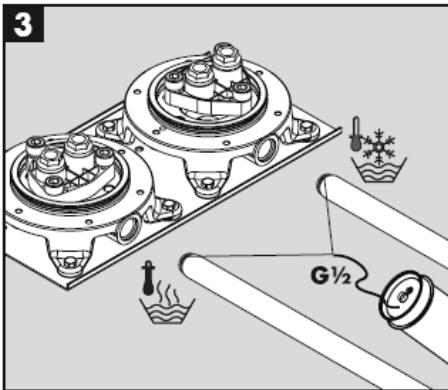
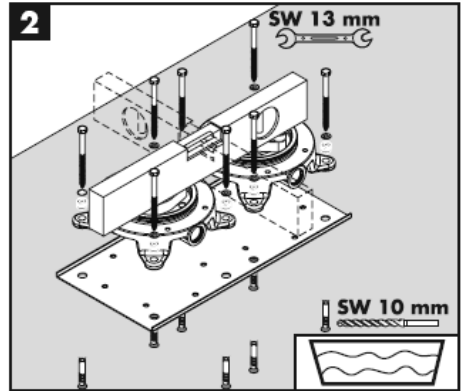
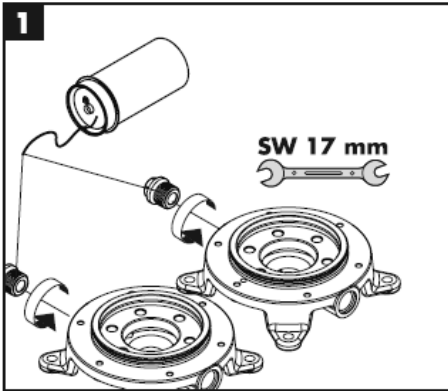

Montagem

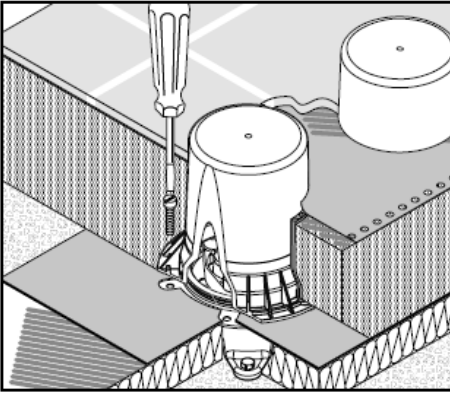

Português

Dados Técnicos

Pressão de funcionamento: max. 1 MPa
Pressão de func. recomendada: 0,1 – 0,5 MPa
Pressão testada: 1,6 MPa
(1 MPa = 10 bar = 147 PSI)
Temperatura da água quente: max. 80° C
Temp. água quente recomendada: 65° C

Peças de substituição ver página 10 – 11

Set de fixação 96260000
Vedante 96459000
Parafuso hexagonal M 10 x 35 97670000

Acessórios especiais

* Disco de borracha 96441000
(não incluído no volume de fornecimento)

Marca de controlo

	DVGW	P-IX	SVGW	ACS	NF	WRAS	KIWA
10452180				x		X	
16549180		PA-IX 18729/ICB					

hansgrohe

Instrukcja montażu

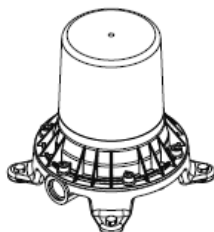

Starck
10452180

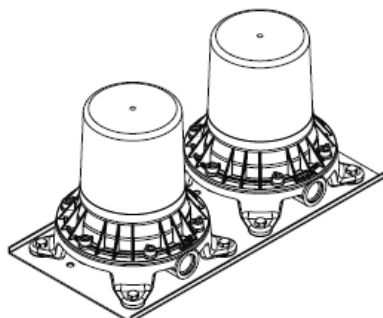

Montreux
16549180

AXOR[®]

hansgrohe

Starck 10458XXX

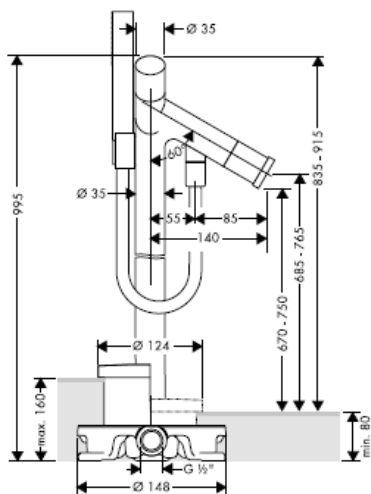

Starck 10060XXX

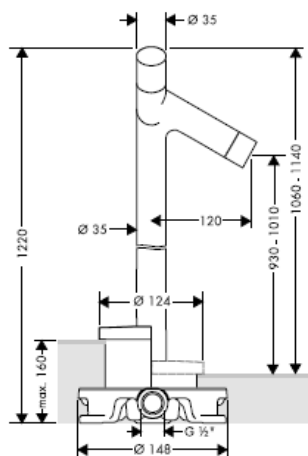

Starck 10456XXX

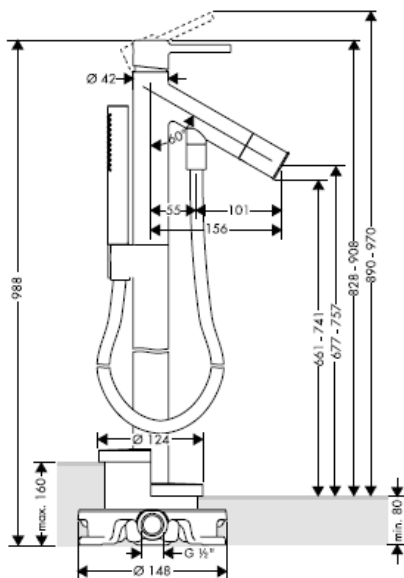

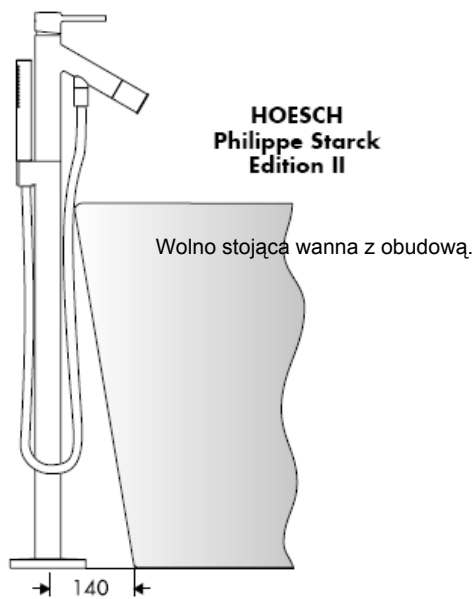
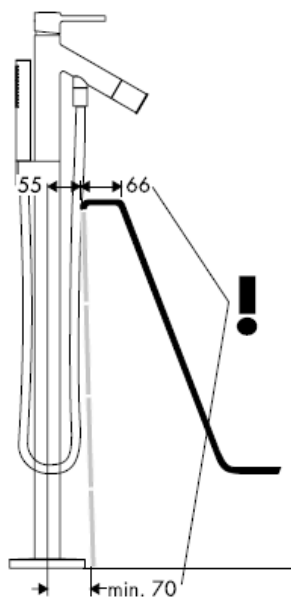
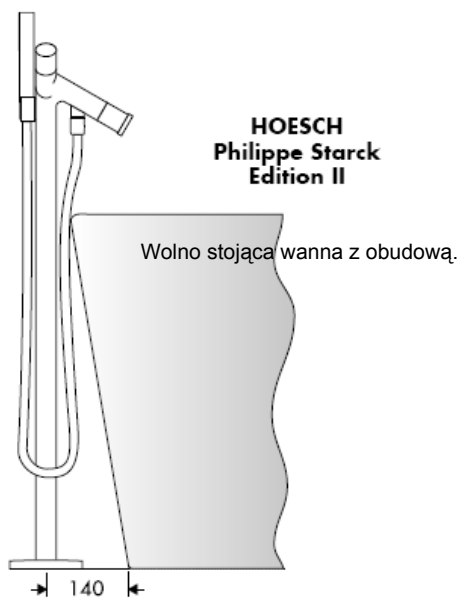

Starck X 10406000

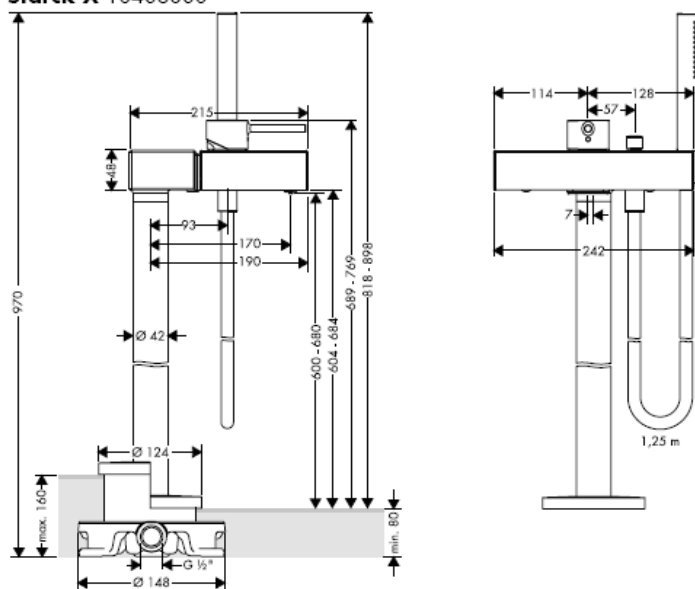

Montreux 16547XXX

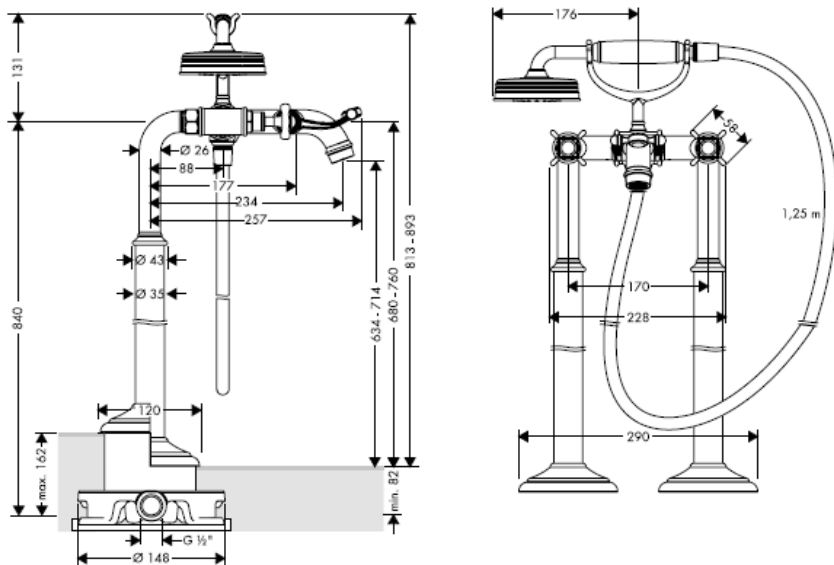

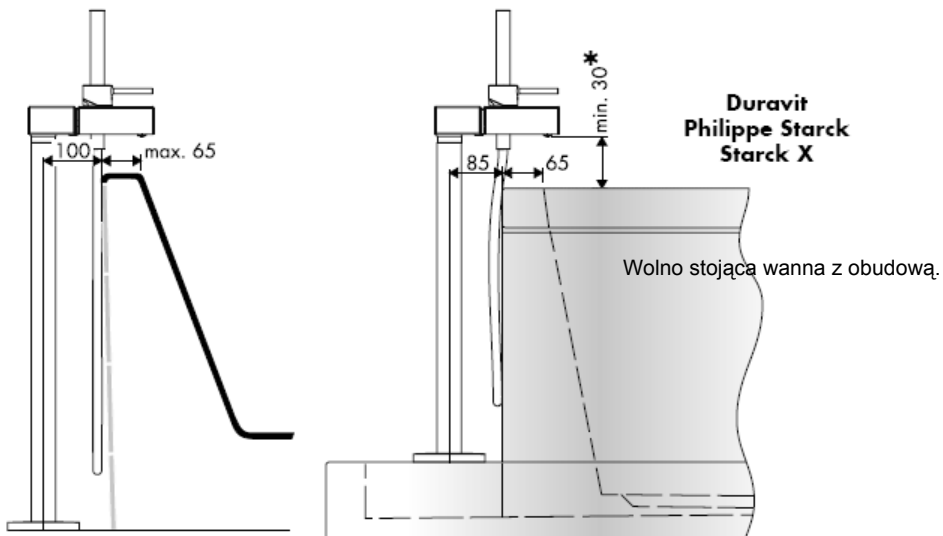

* < 30 min = Przedłużacz 60 mm (nr art. 97686000)



Massaud 18450000

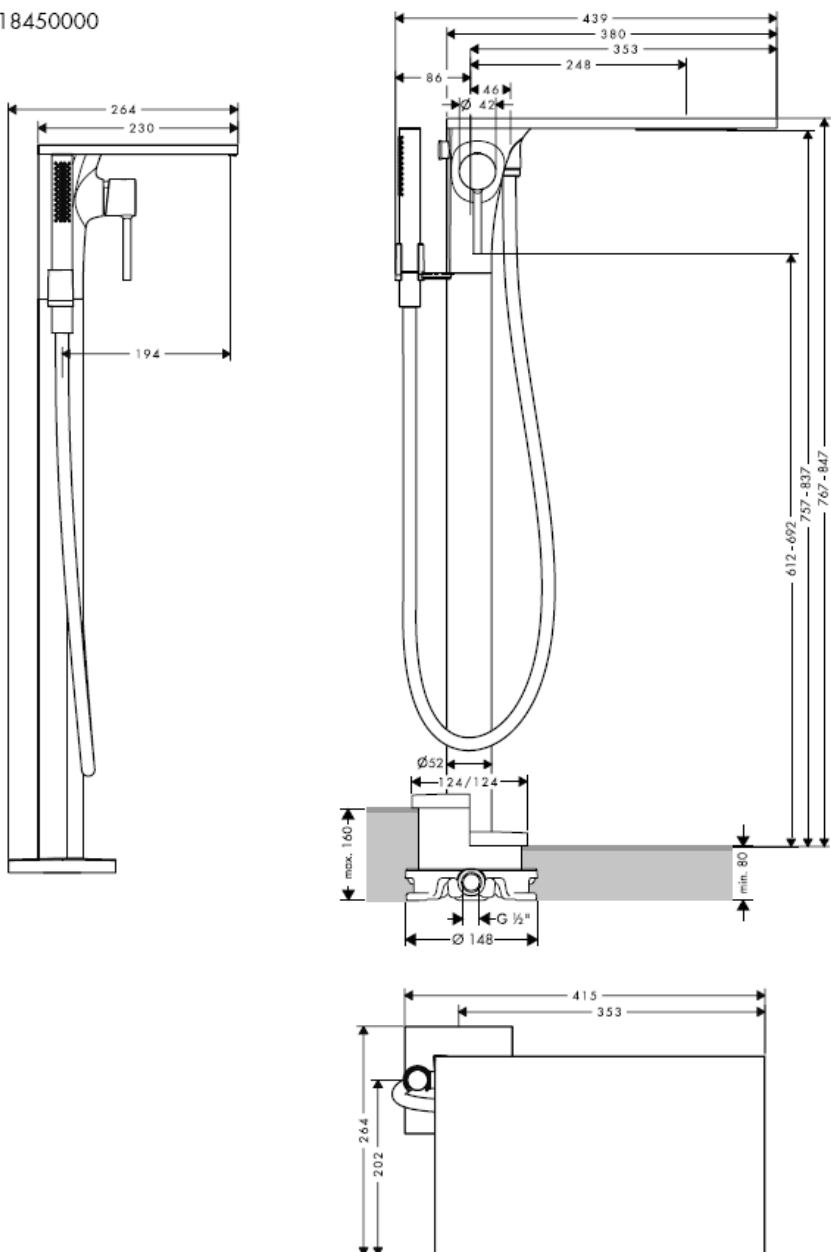

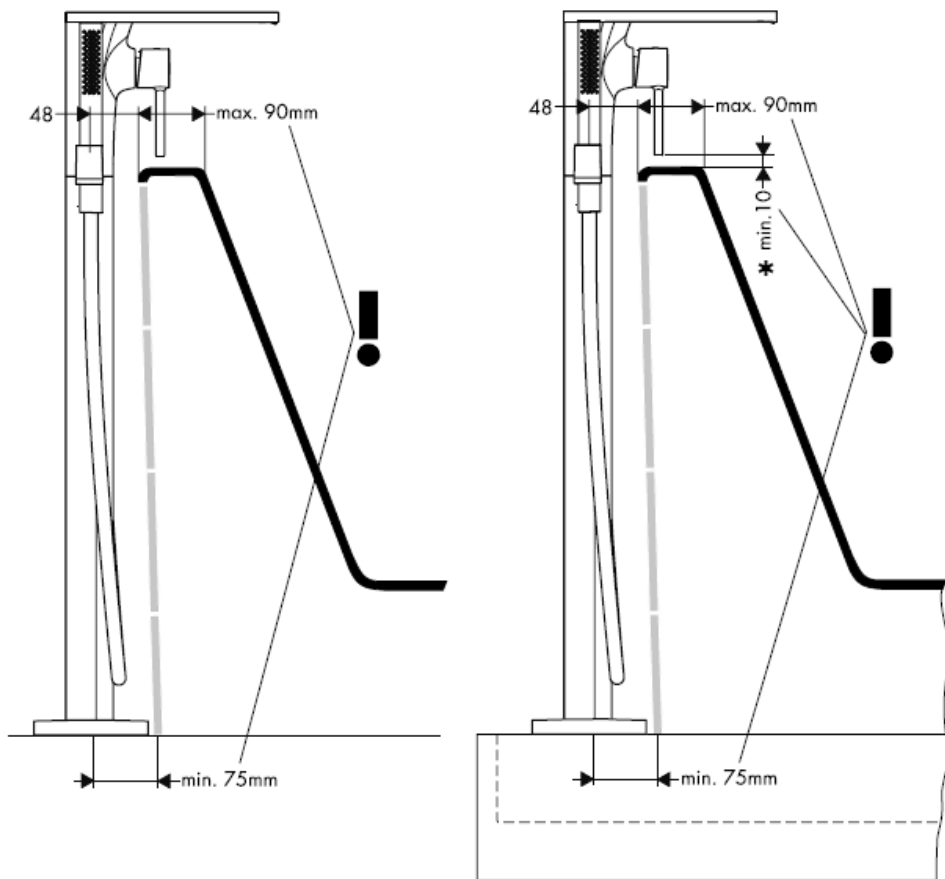

* < 10 min = Przedłużacz 60 mm (nr art. 97686000)

Citterio 39451000

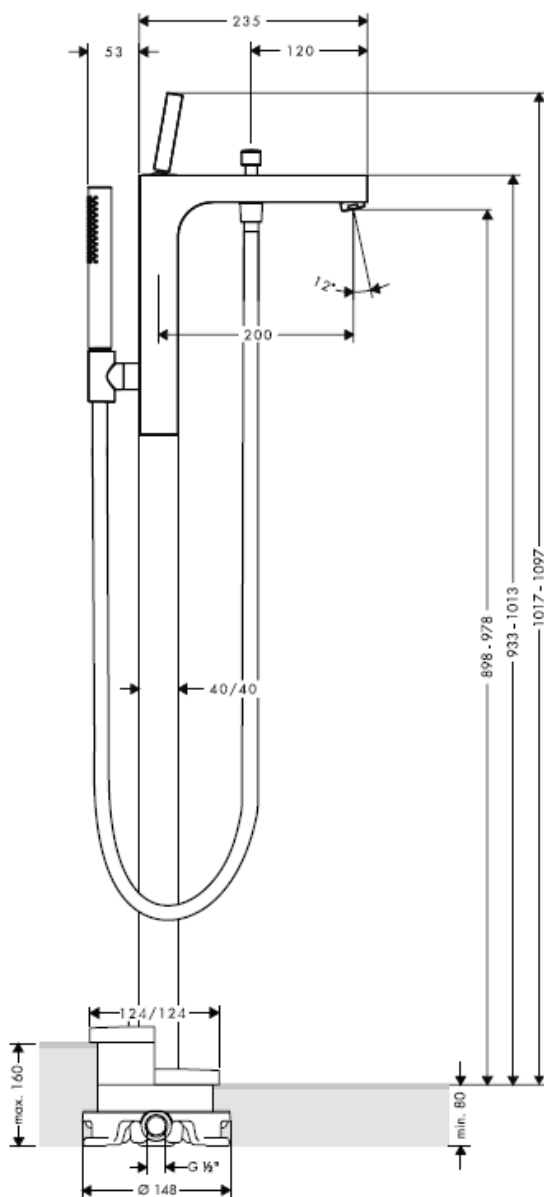

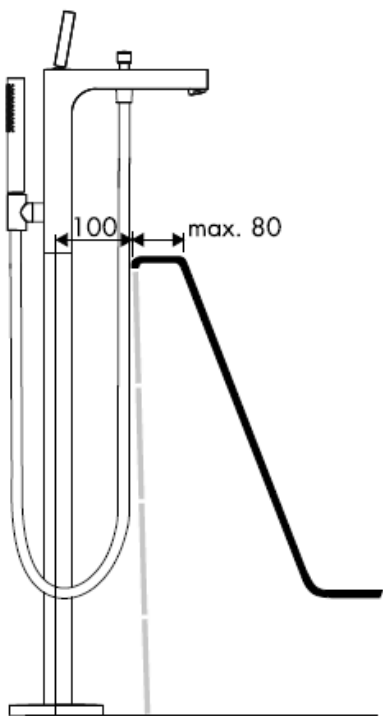

Uwaga! Armatura musi być zamontowana, przepłukana i wypróbowana według obowiązujących norm!

Starck 10452180

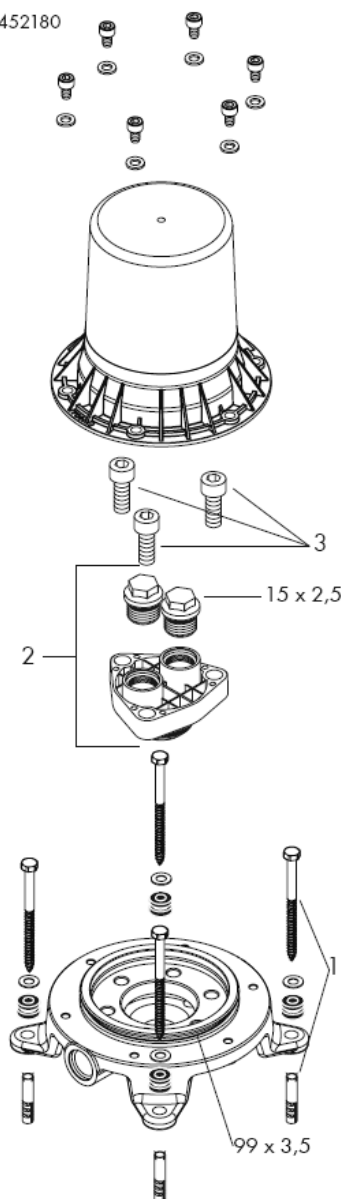

Montreux 16549180

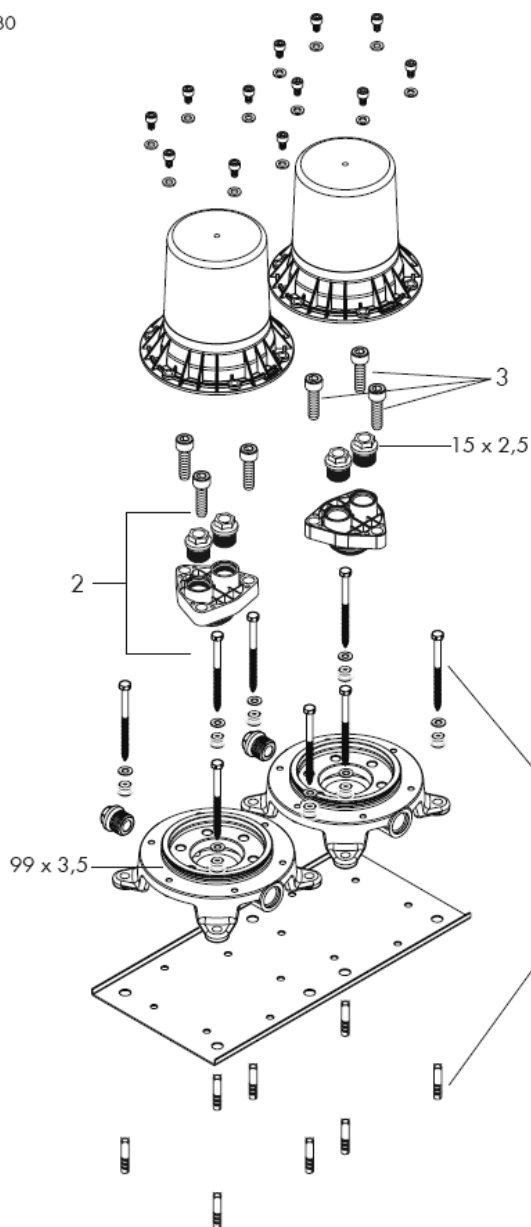

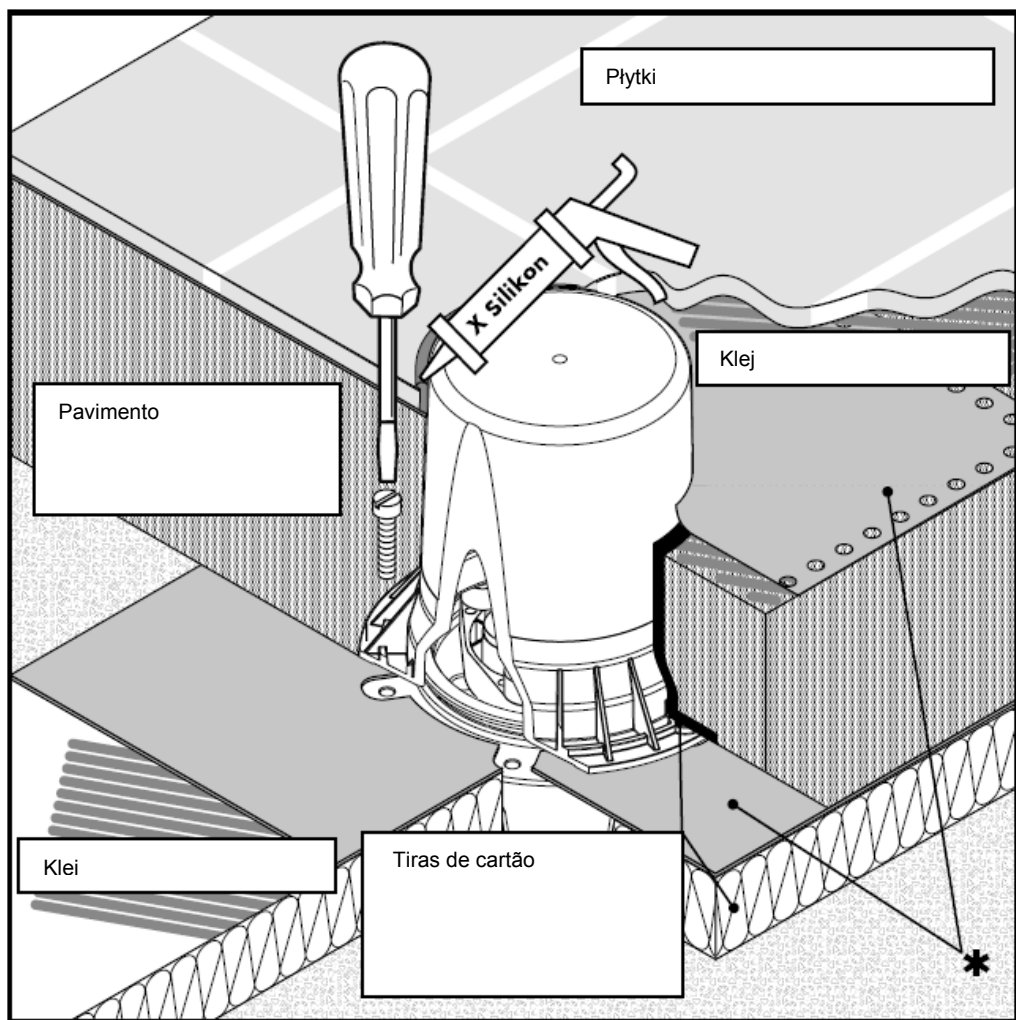

* Opcjonalnie dostępna uszczelka

X Silikon (neutralny)

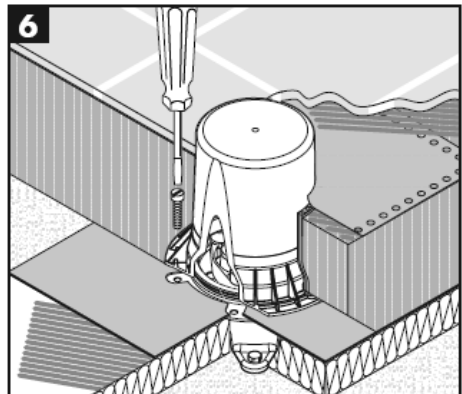
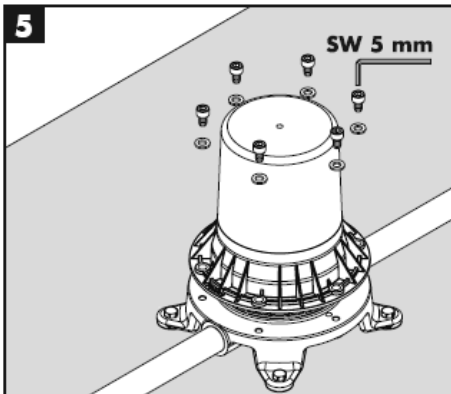
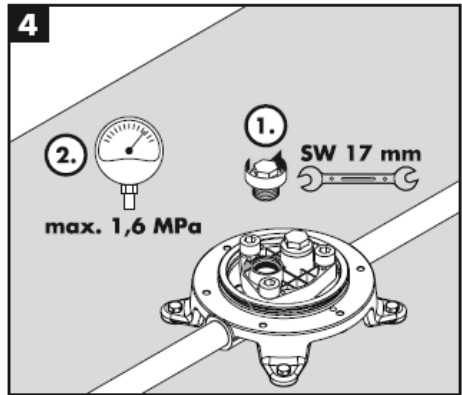
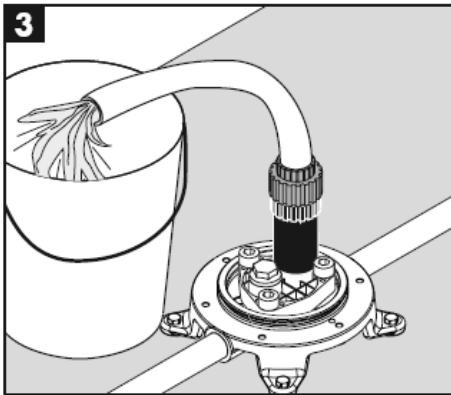
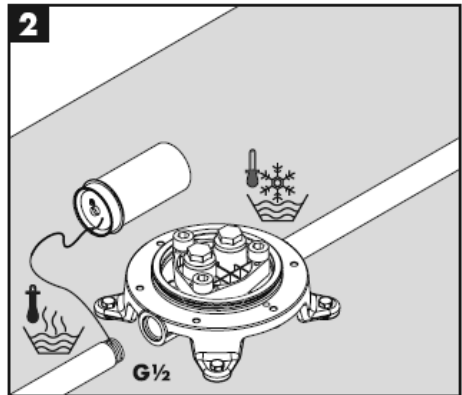
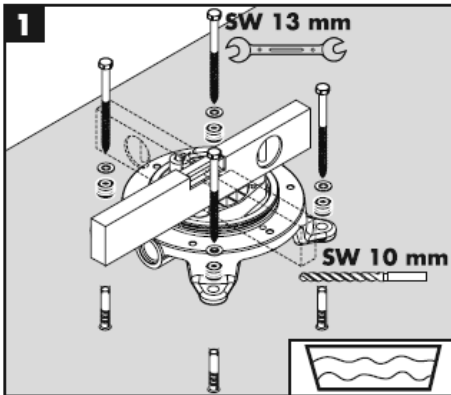

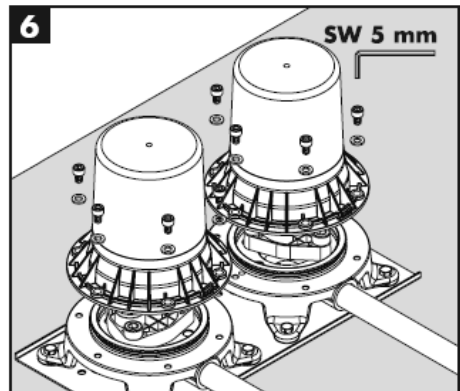
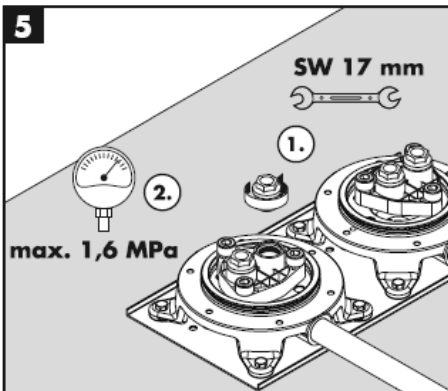
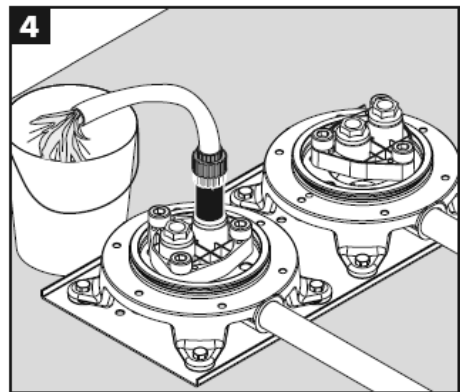
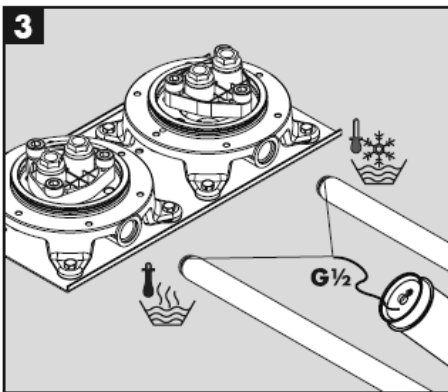
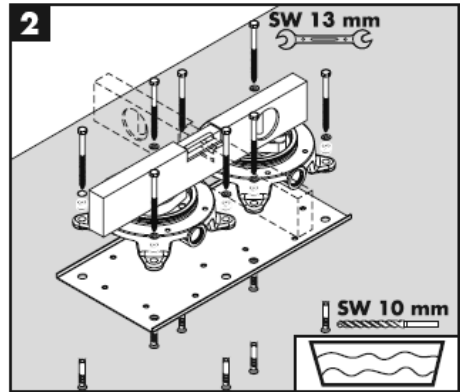
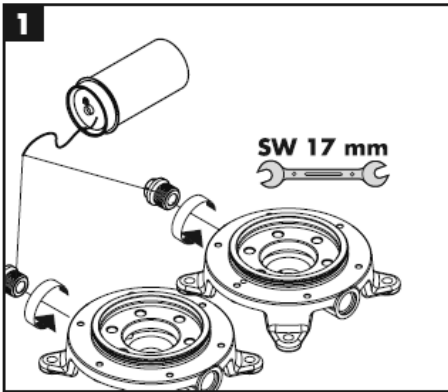

Montaż

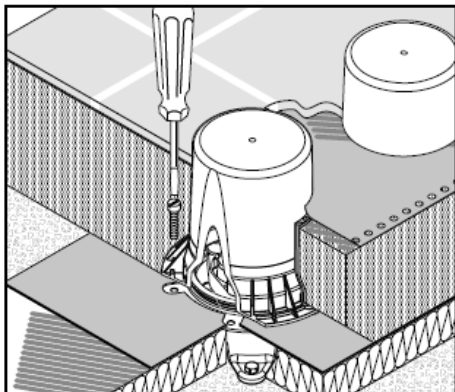

Polski

Dane techniczne

Ciśnienie robocze:	max. 1 MPa
Zalecane ciśnienie robocze:	0,1 – 0,5 MPa
Ciśnienie próbne:	1,6 MPa
(1 MPa = 10 bary = 147 PSI)	
Temperatura wody gorącej:	max. 80° C
Zalecana temperatura wody gorącej:	65° C

Części serwisowe patrz strona 10 – 11

Zestaw mocujący	96260000
Zestaw uszczelek	96459000
Śruba cylindryczna M 10 x 35	97670000

Wyposażenie specjalne

* Uszczelka mocująca (Nie jest częścią dostawy)	96441000
--	----------

Znak jakości

	DVGW	P-IX	SVGW	ACS	NF	WRAS	KIWA
10452180				x		X	
16549180		PA-IX 18729/ICB					

hansgrohe

Montážní návod

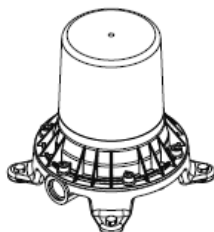

Starck
10452180

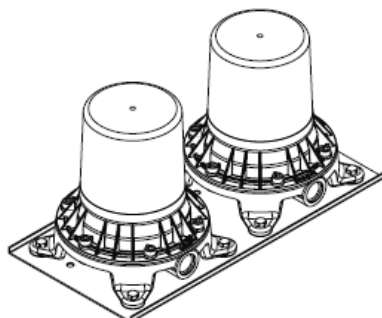

Montreux
16549180

AXOR[®]

hansgrohe

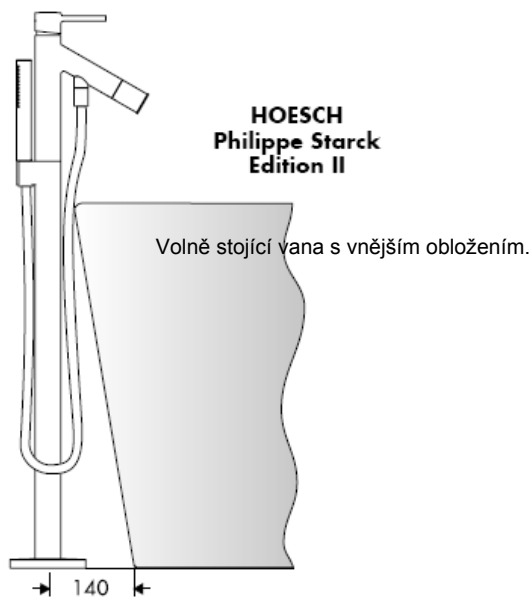
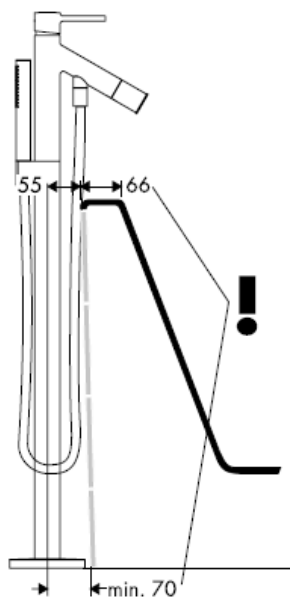
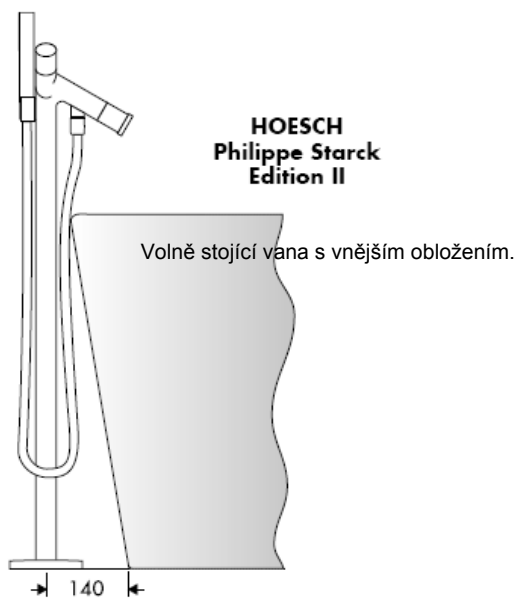

Starck X 10406000

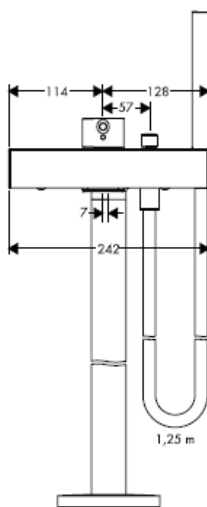
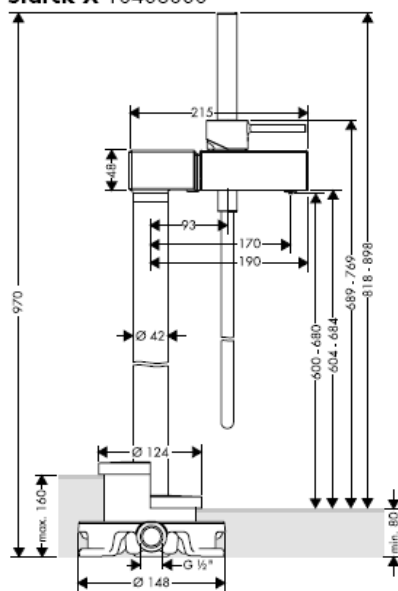

Montreux 16547XXX

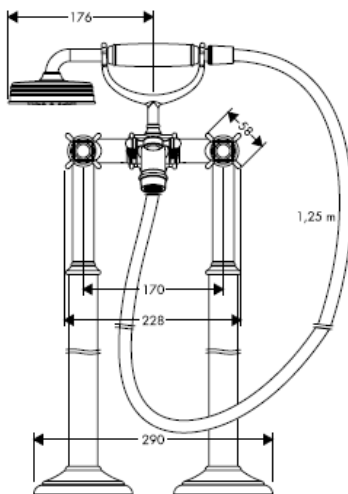
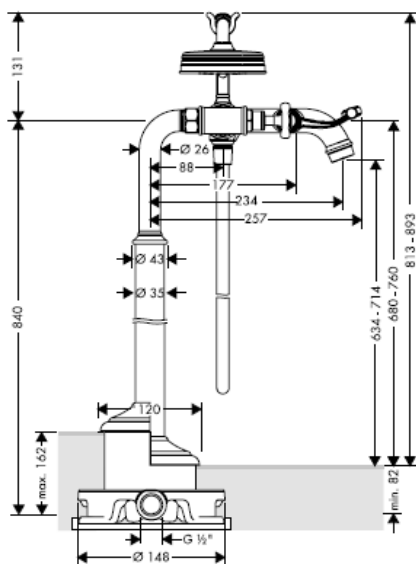

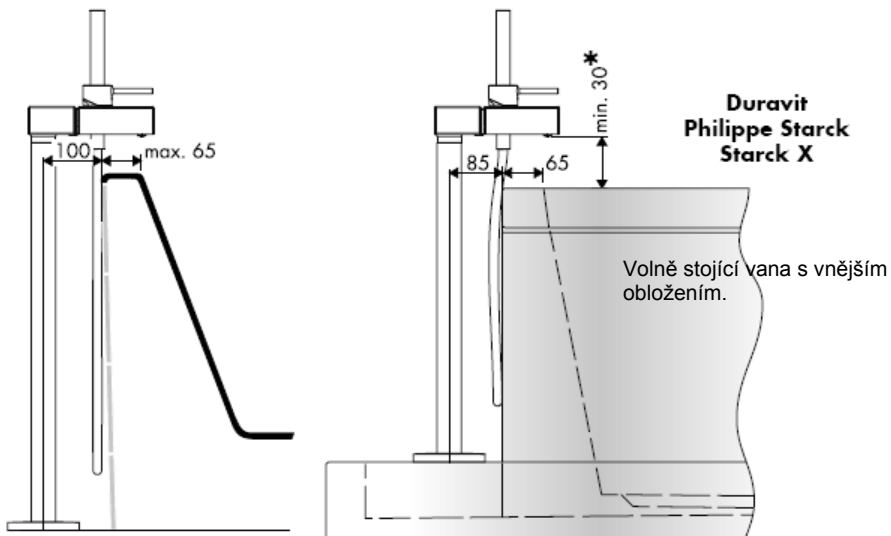

* < 30 min = prodloužení 60 mm (kat.č. 97686000)



Massaud 18450000

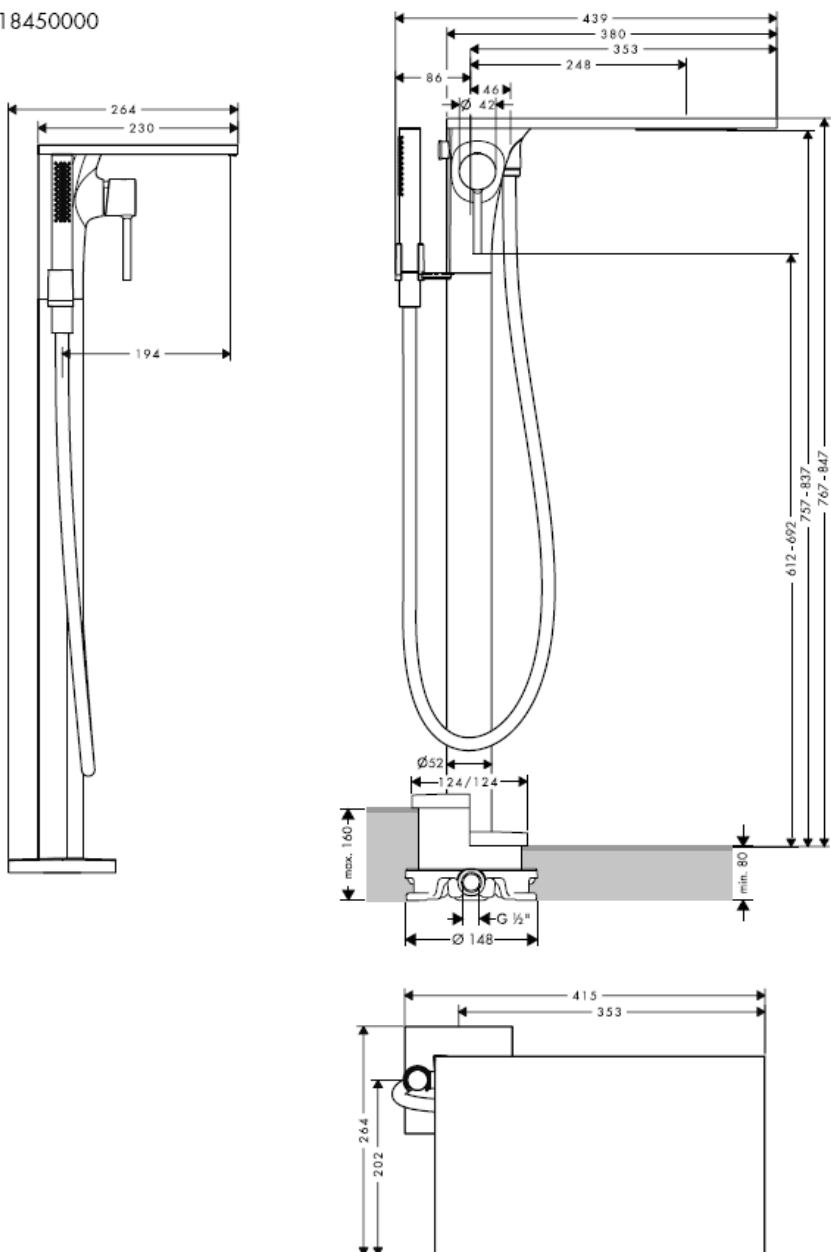

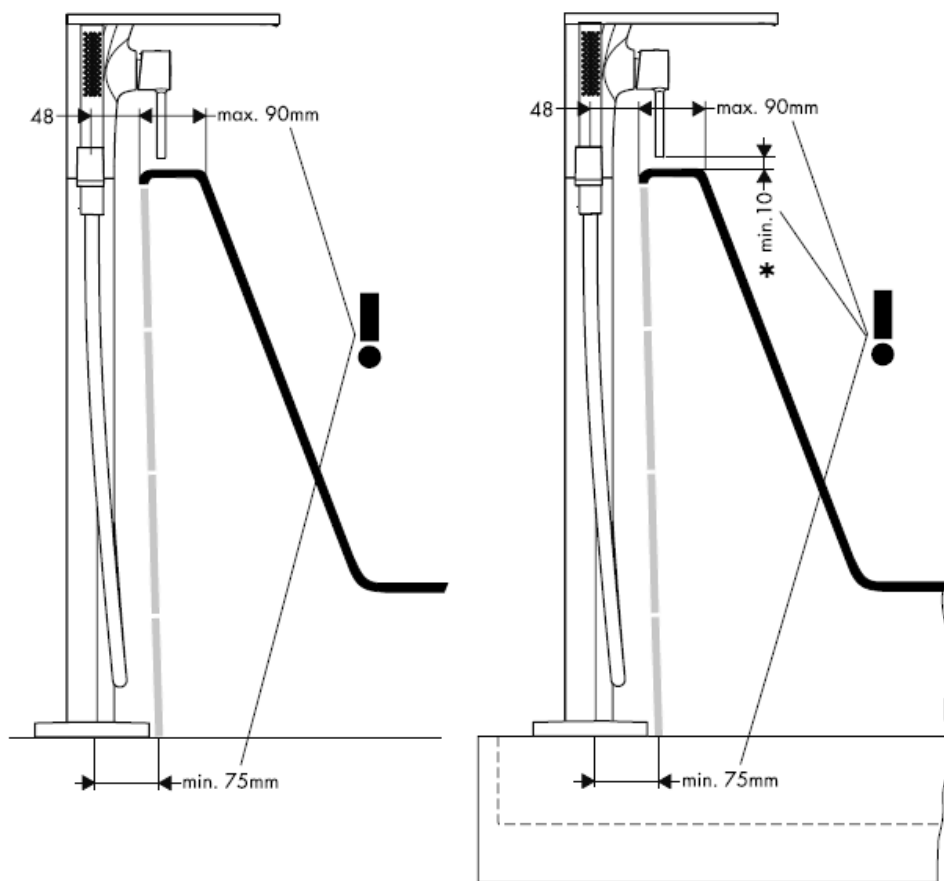

* < 10 min = prodloužení 60 mm (kat.č. 97686000)

Citterio 39451000

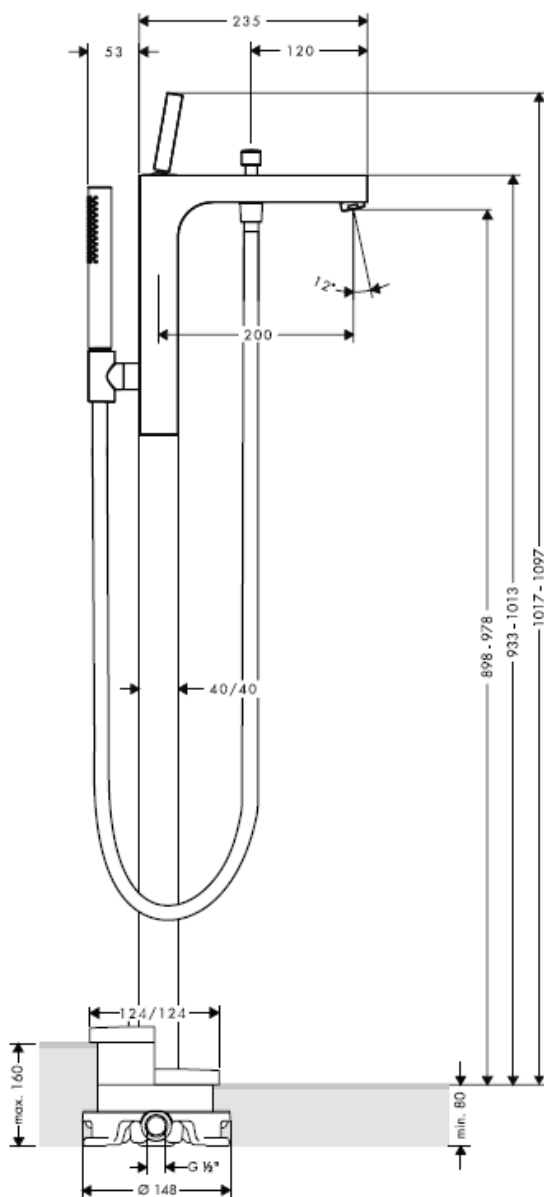

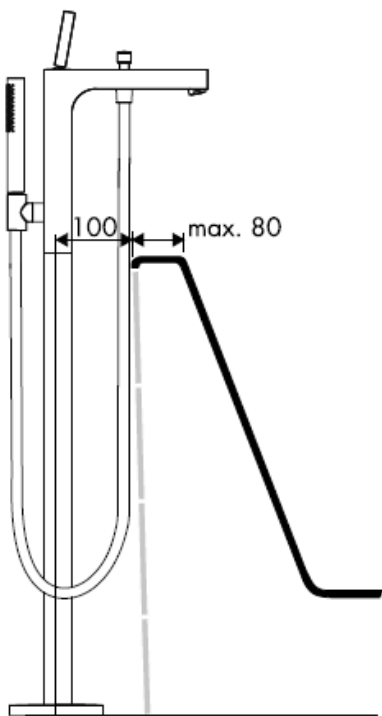

Pozor! Armatura se musí montovat,
proplachovat a testovat podle platných norem!

Starck 10452180

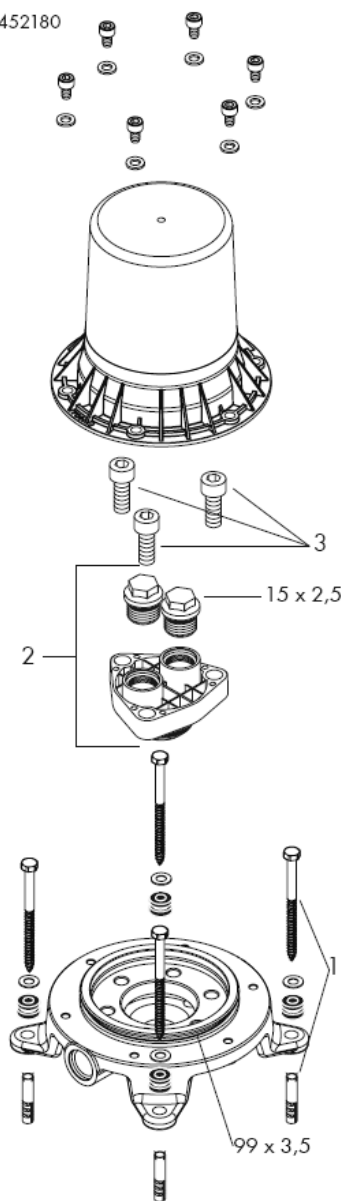

Montreux 16549180

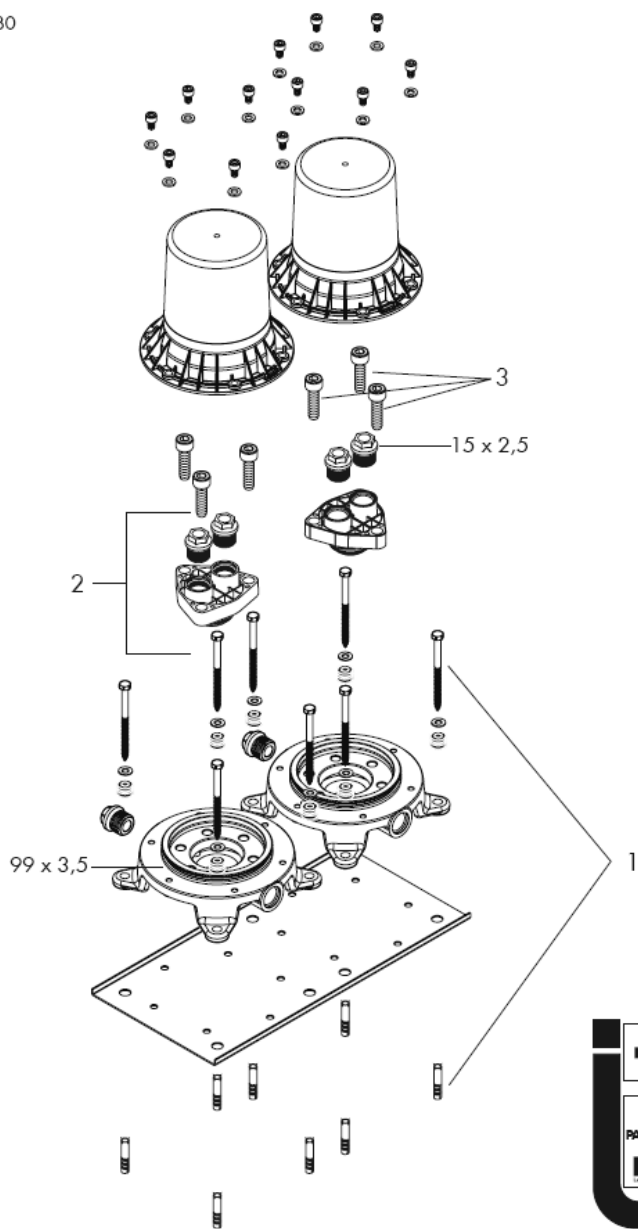

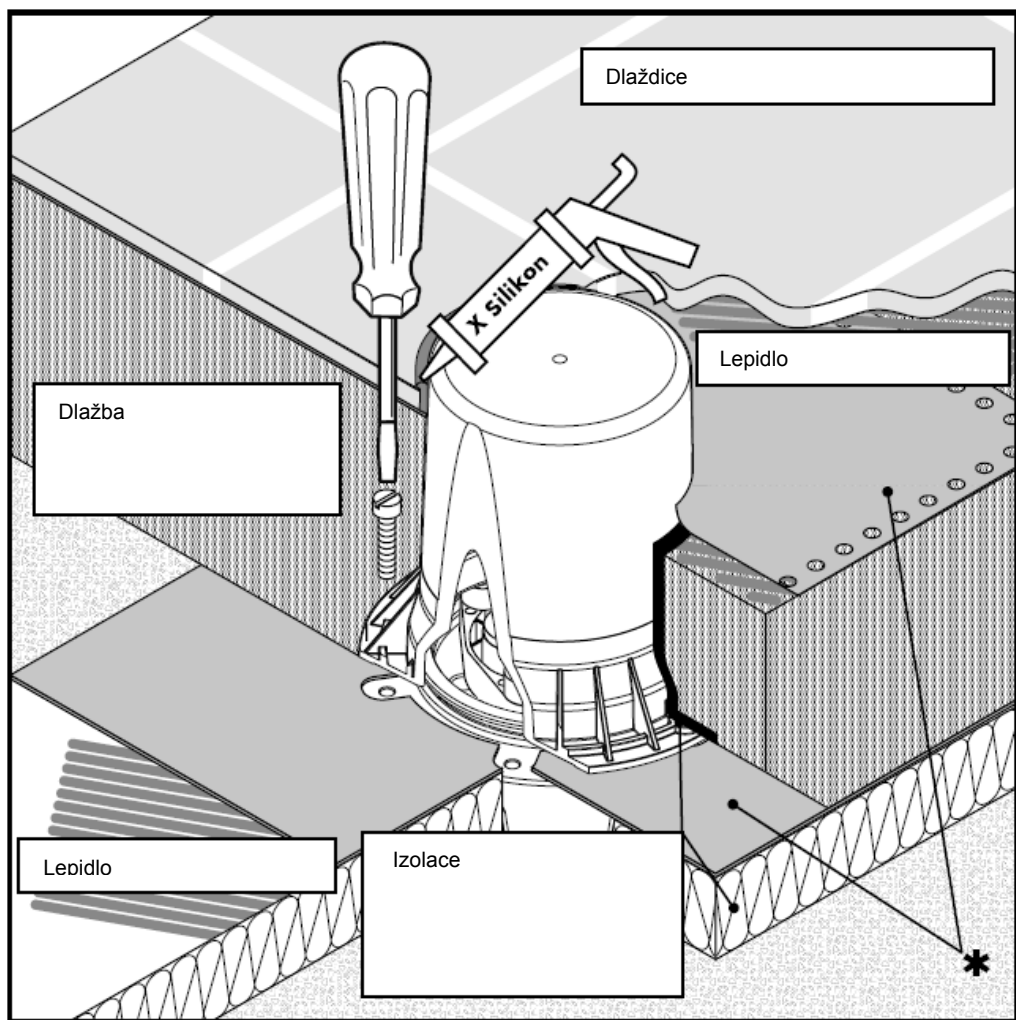

* opčně dostupná těsnicí manžeta

X Silicon (bez kyseliny octové!)

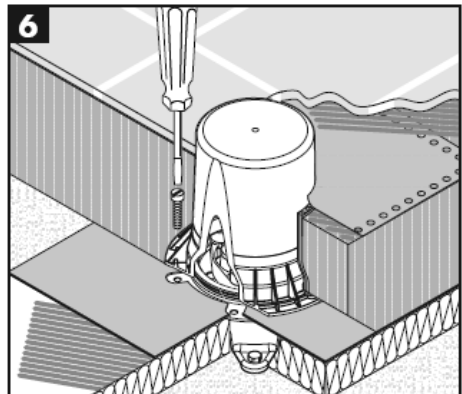
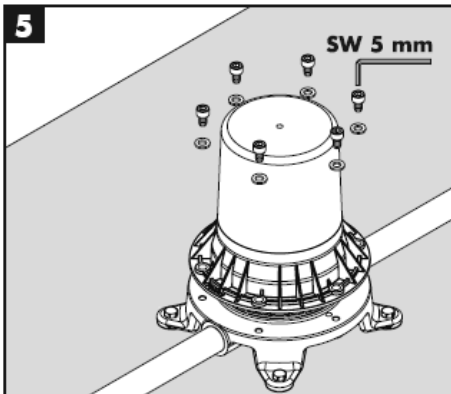
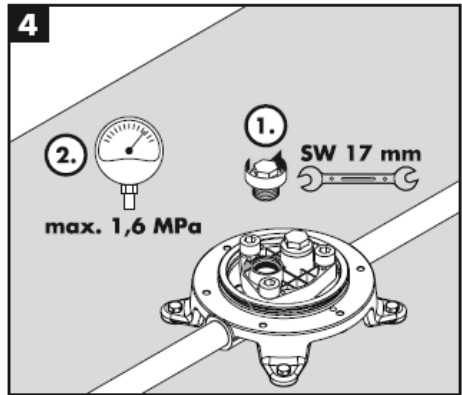
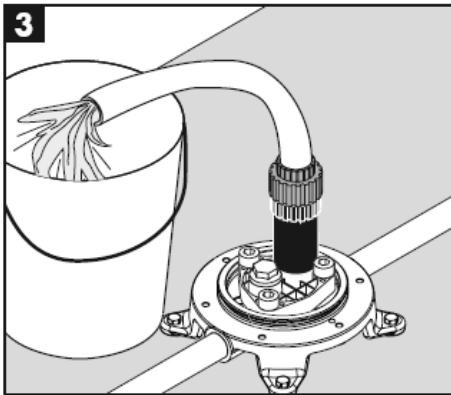
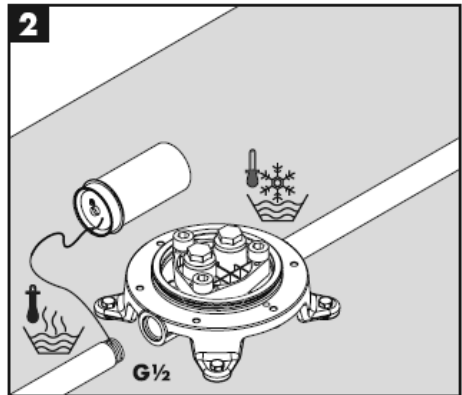
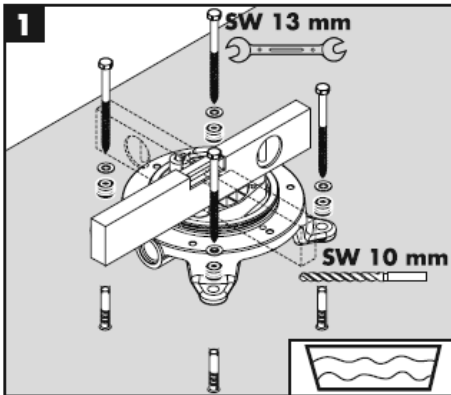

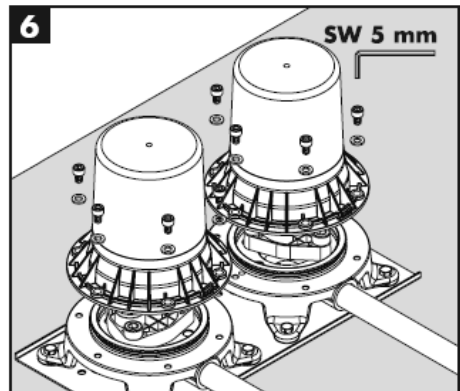
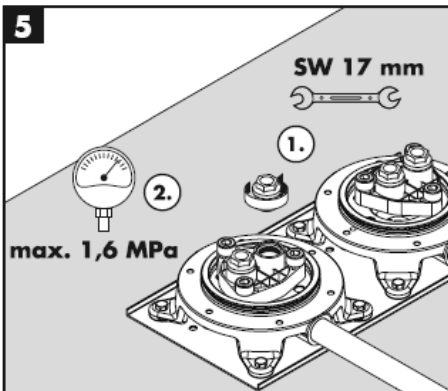
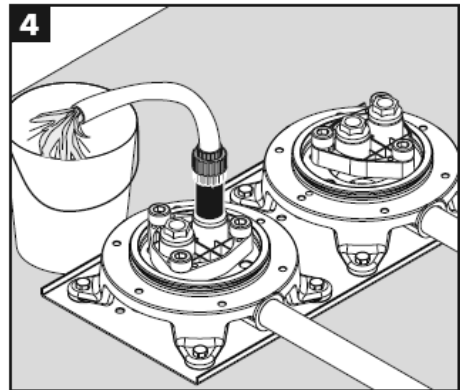
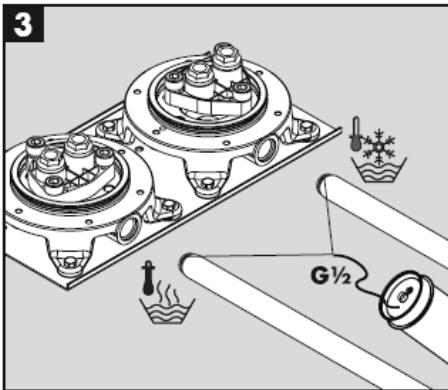
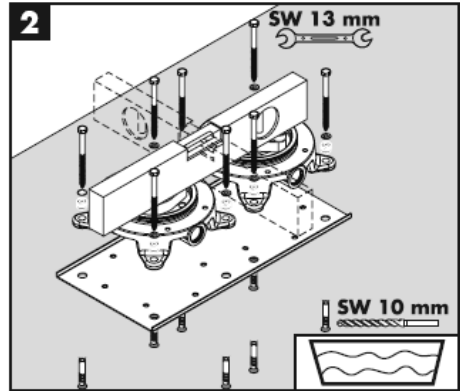
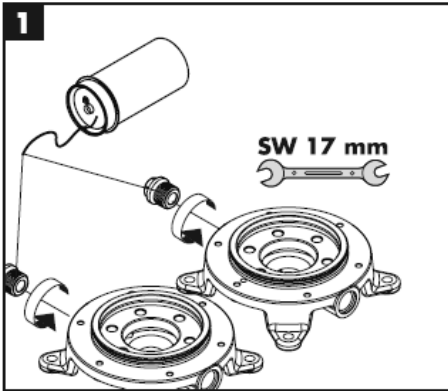

Montáž

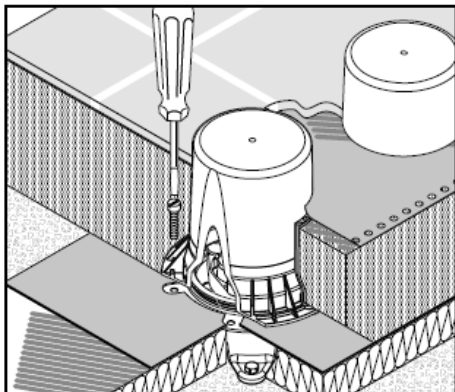

Česky

Technické údaje

Provozní tlak:	max. 1 MPa
Doporučený provozní tlak:	0,1 – 0,5 MPa
Zkušební tlak: (1 MPa = 10 bar = 147 PSI)	1,6 MPa
Teplota horké vody:	max. 80° C
Doporučená teplota horké vody:	65° C

Servisní díly viz strana 10 – 11

montážní sada	96260000
sada těsnění	96459000
šroub s válcovou hlavou M 10 x 35	97670000

Zvláštní příslušenství

* těsnící manžeta (není součástí dodávky)	96441000
--	----------

zkušební značka

	DVGW	P-IX	SVGW	ACS	NF	WRAS	KIWA
10452180				x		X	
16549180		PA-IX 18729/ICB					

hansgrohe

Montážny návod

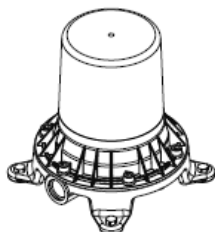

Starck
10452180

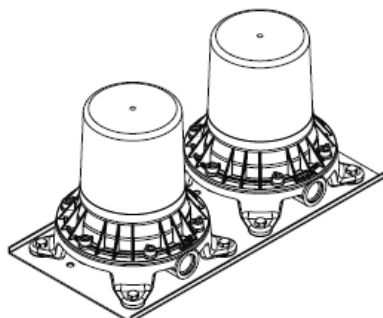

Montreux
16549180

AXOR[®]

hansgrohe

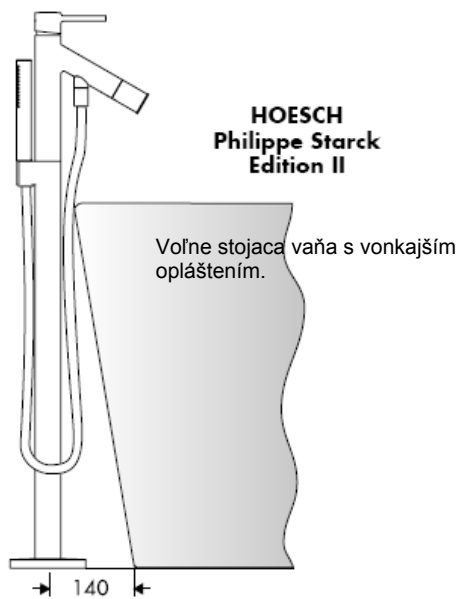
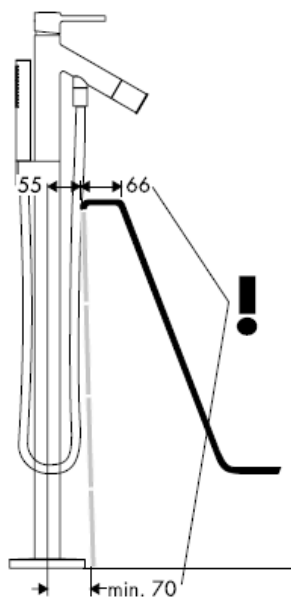
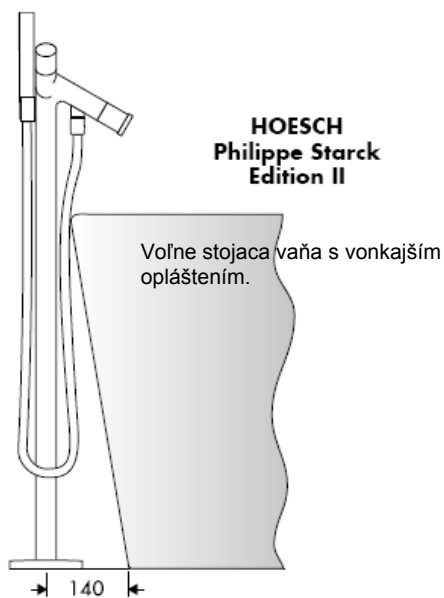

Starck X 10406000

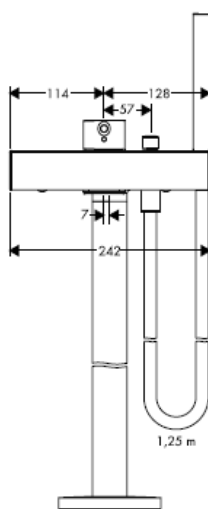
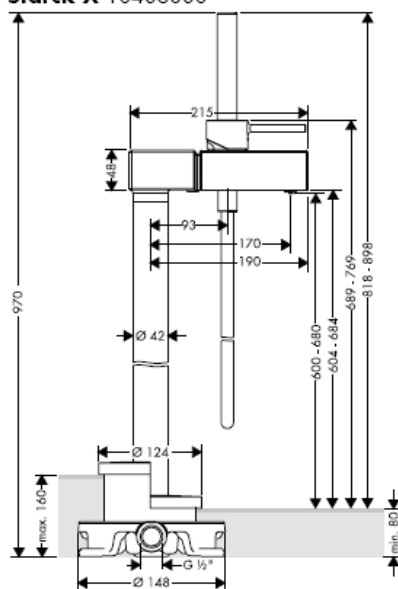

Montreux 16547XXX

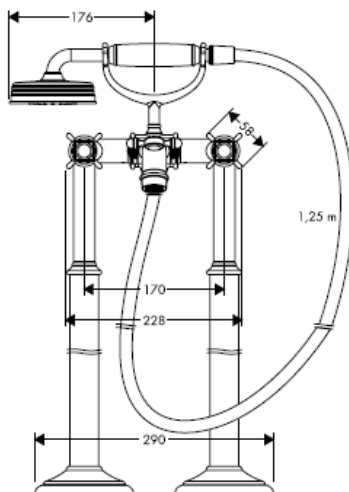
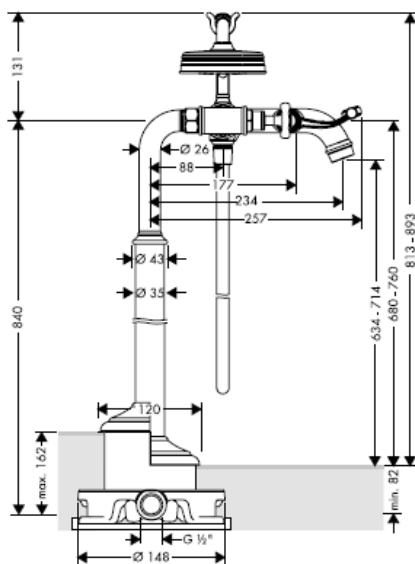

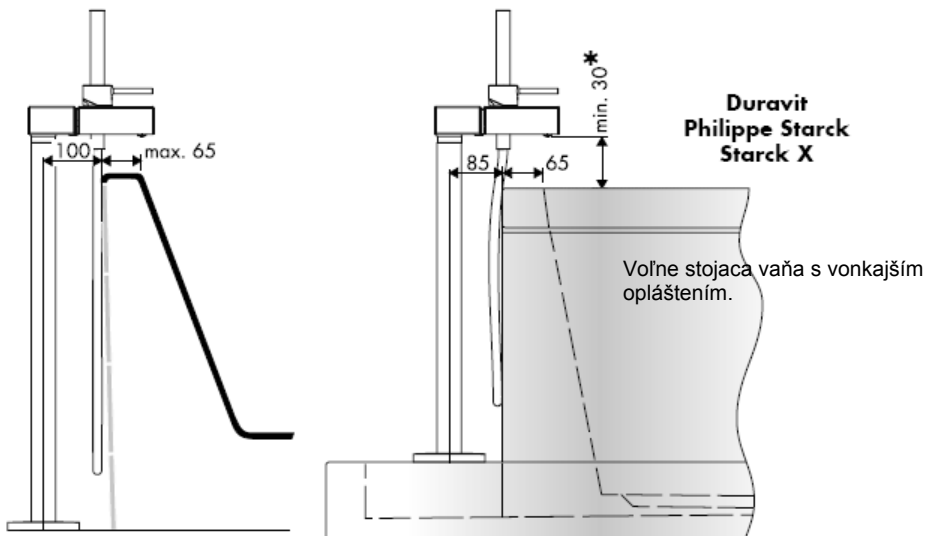

* < 30 min = Predĺženie 60 mm (výrobné číslo 97686000)



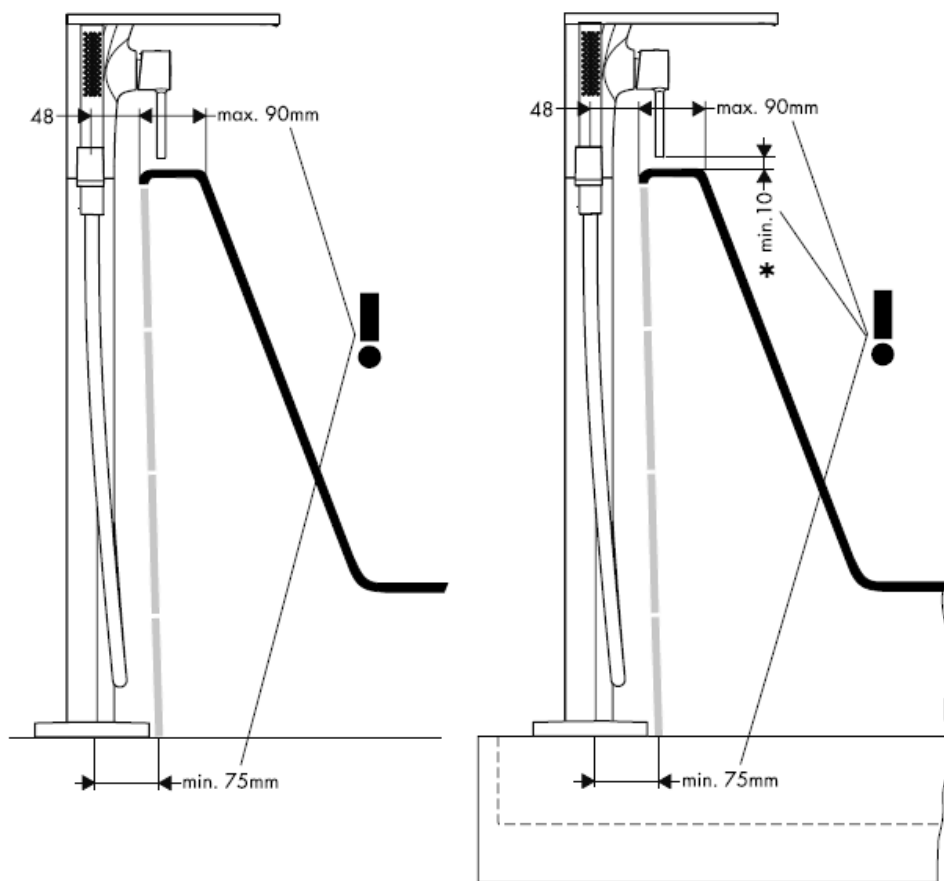

* < 10 min = Predĺženie 60 mm (výrobné číslo 97686000)

Citterio 39451000

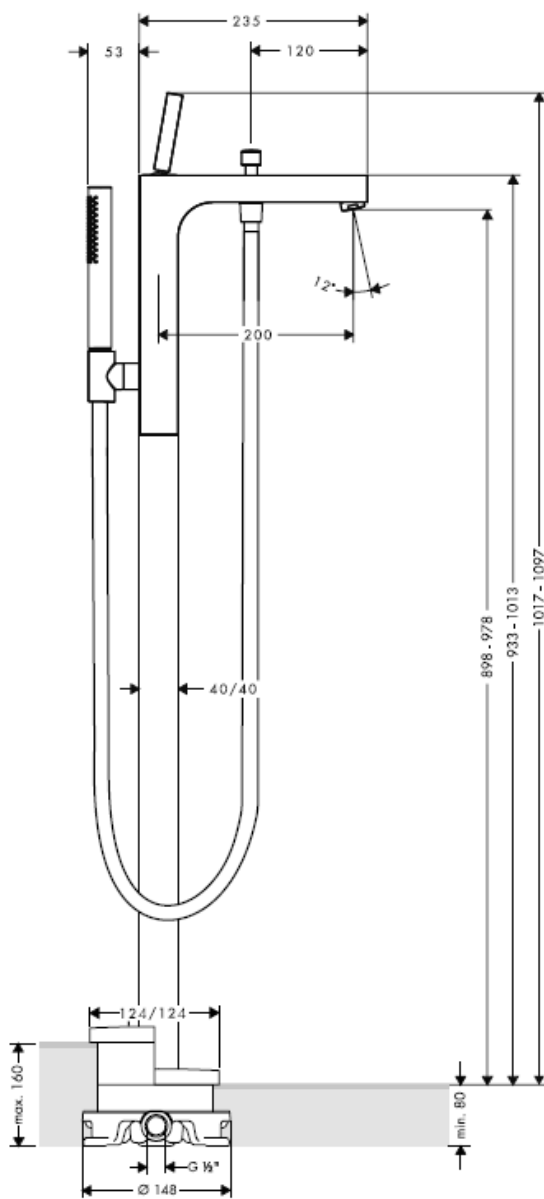

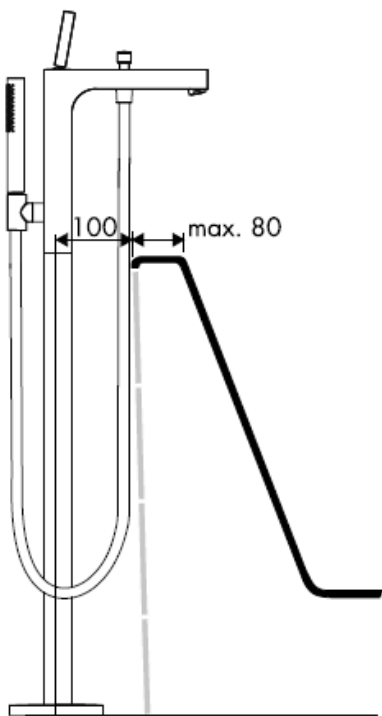

Pozor! Batéria sa musí montovať, preplachovať a testovať podľa platných noriem!

Starck 10452180

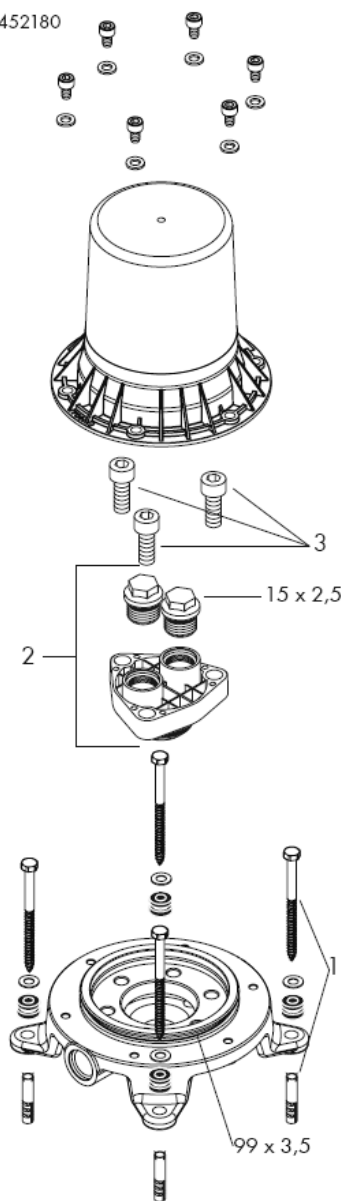

Montreux 16549180

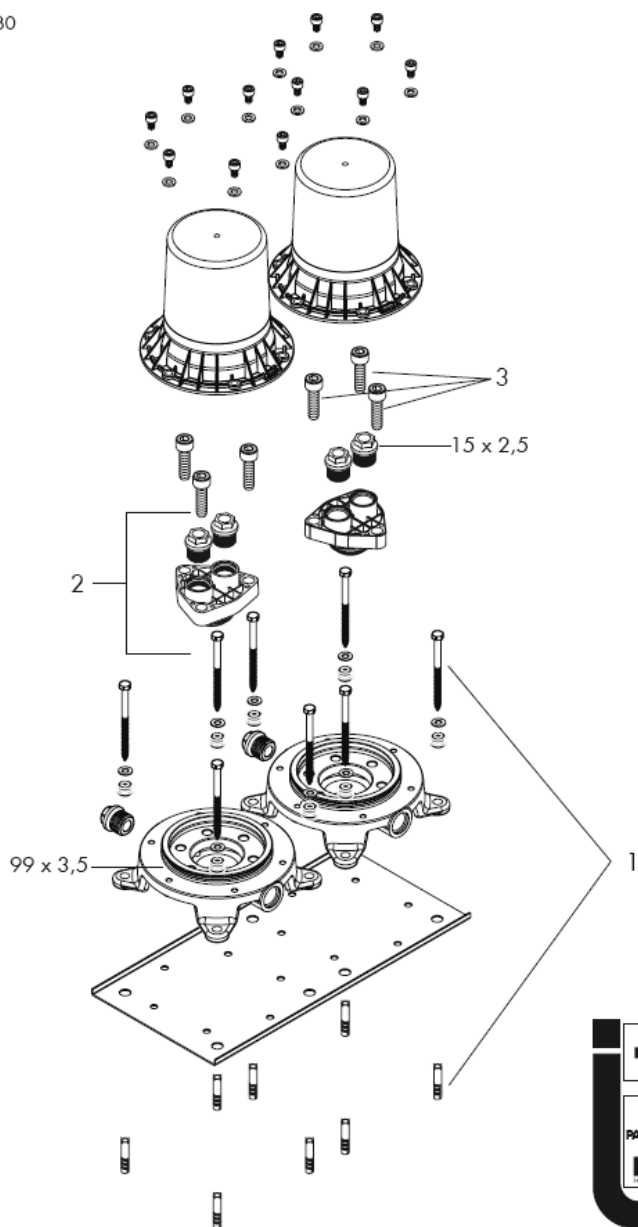

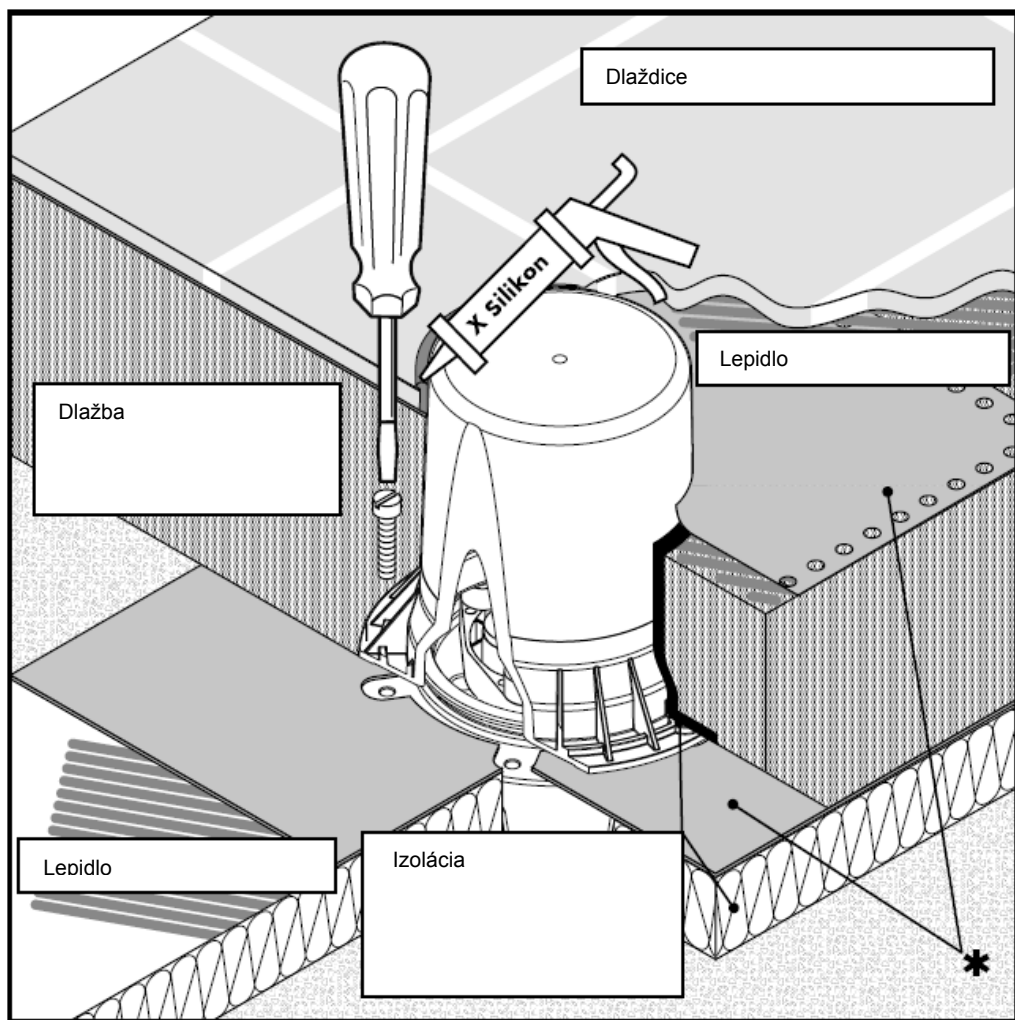

* v prípade potreby objednať tesniacu

X Silicon (bez kyseliny octovej!)

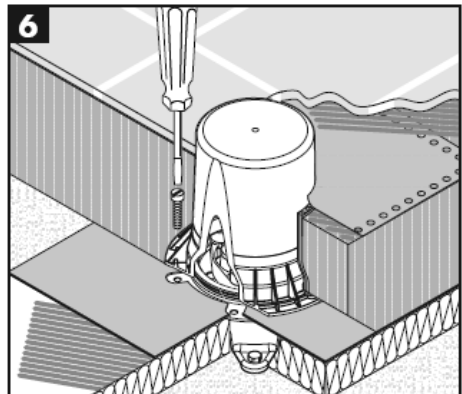
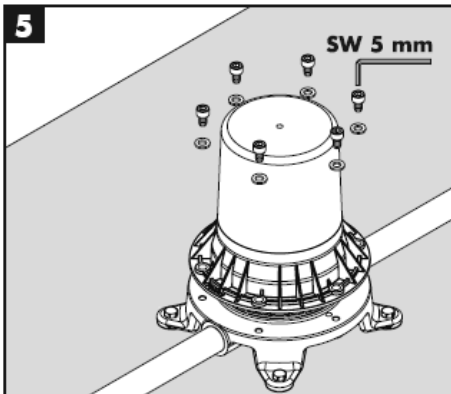
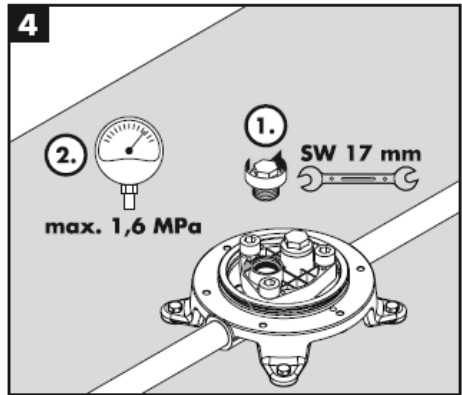
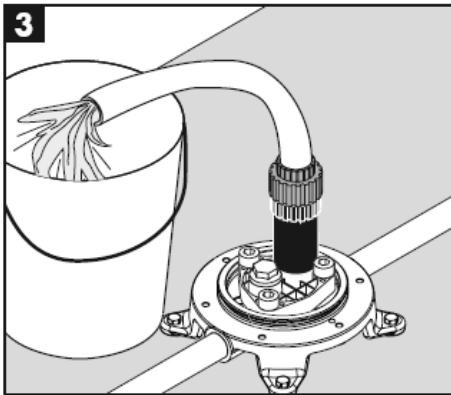
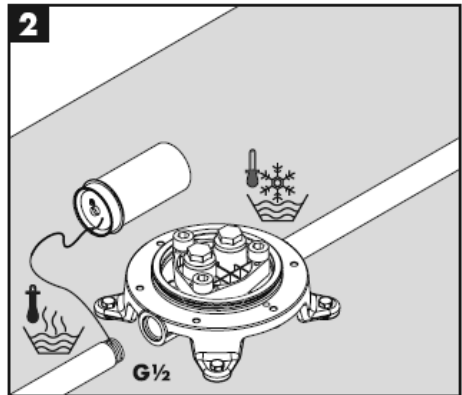
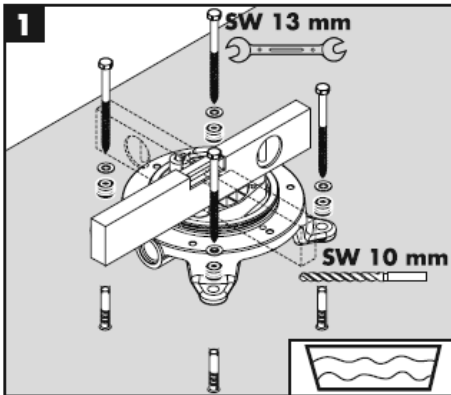

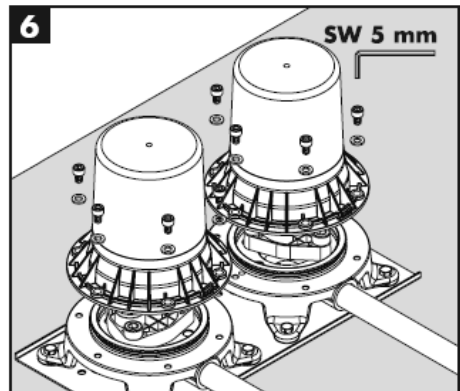
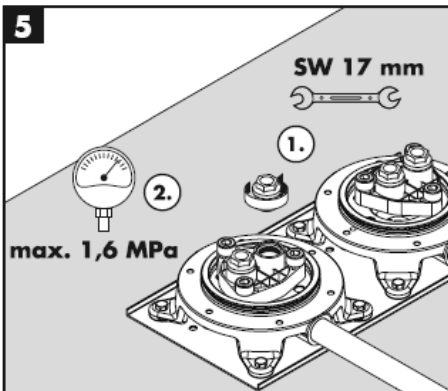
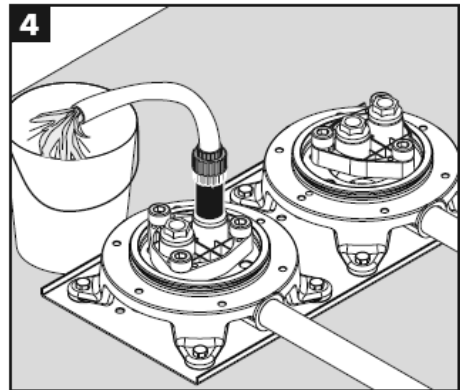
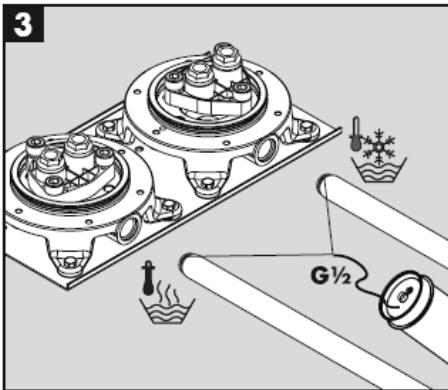
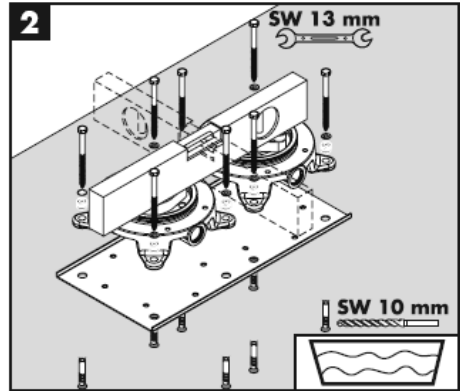
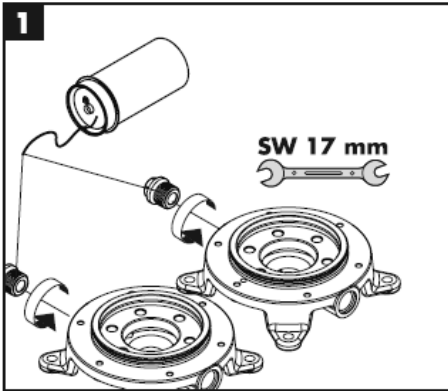

Montáž

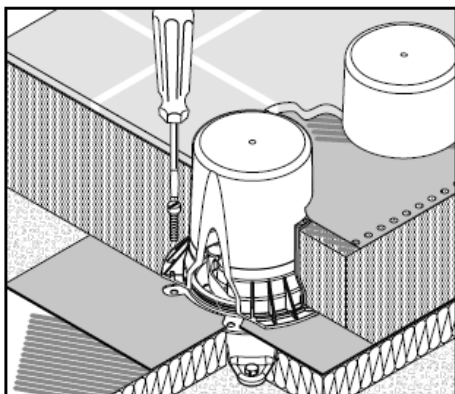

Slovensky

Technické údaje

Prevádzkový tlak:	max. 1 MPa
Doporučený prevádzkový tlak:	0,1 – 0,5 MPa
Skúšobný tlak: (1 MPa = 10 bar = 147 PSI)	1,6 MPa
Teplota teplej vody:	max. 80° C
Doporučená teplota teplej vody:	65° C

Servisné diely viď strana 10 – 11

montážna súprava	96260000
sada tesnení	96459000
skrutka s valcovou hlavou M 10 x 35	97670000

Zvláštne príslušenstvo

* tesniaca manžeta (nie je súčasťou dodávky)	96441000
---	----------

Osvedčenie o skúške

	DVGW	P-IX	SVGW	ACS	NF	WRAS	KIWA
10452180				x		X	
16549180		PA-IX 18729/ICB					

hansgrohe

组装说明

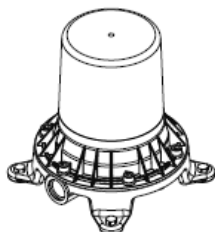

Starck
10452180

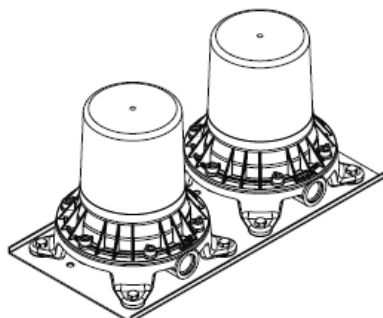

Montreux
16549180

AXOR[®]

hansgrohe

Starck 10458XXX

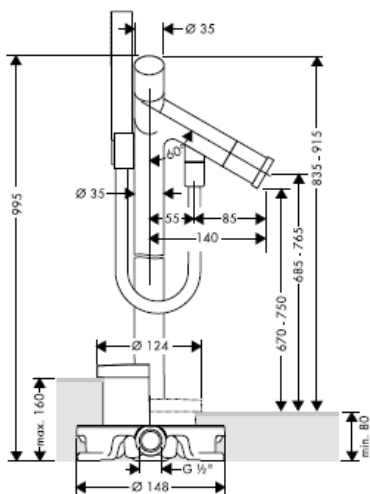

Starck 10060XXX

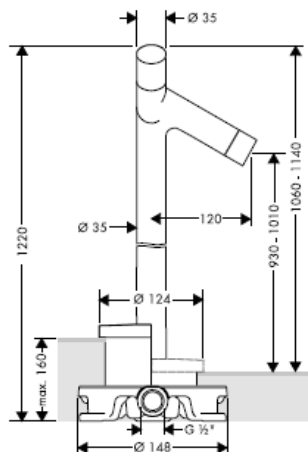

Starck 10456XXX

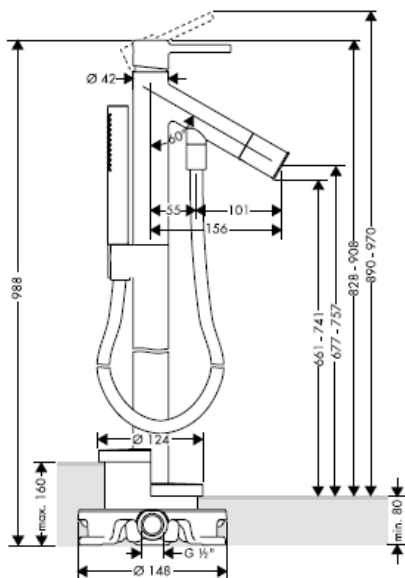

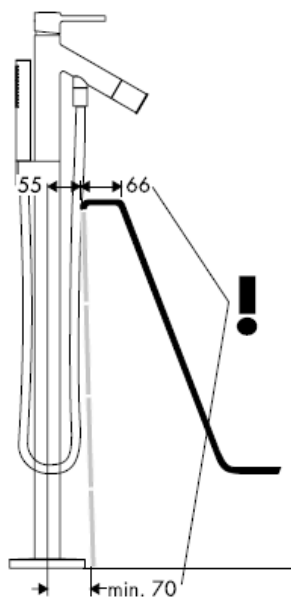
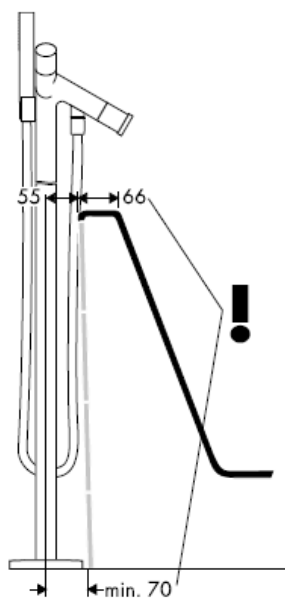

Starck X 10406000

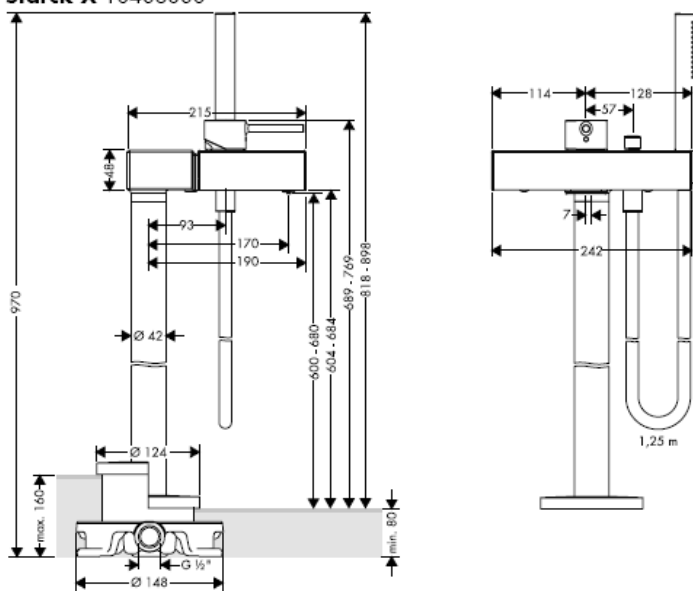

Montreux 16547XXX

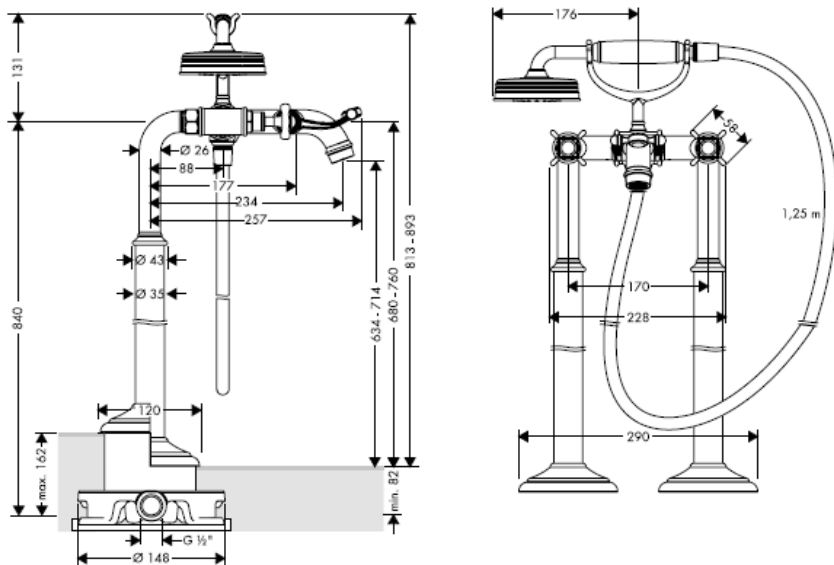

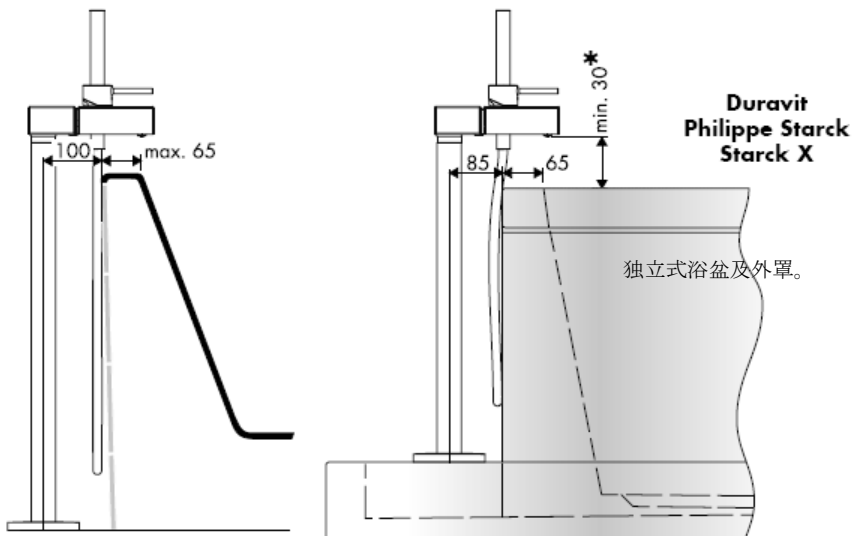

* < 30 min = 加长 (商品编号 97686000)



Massaud 18450000

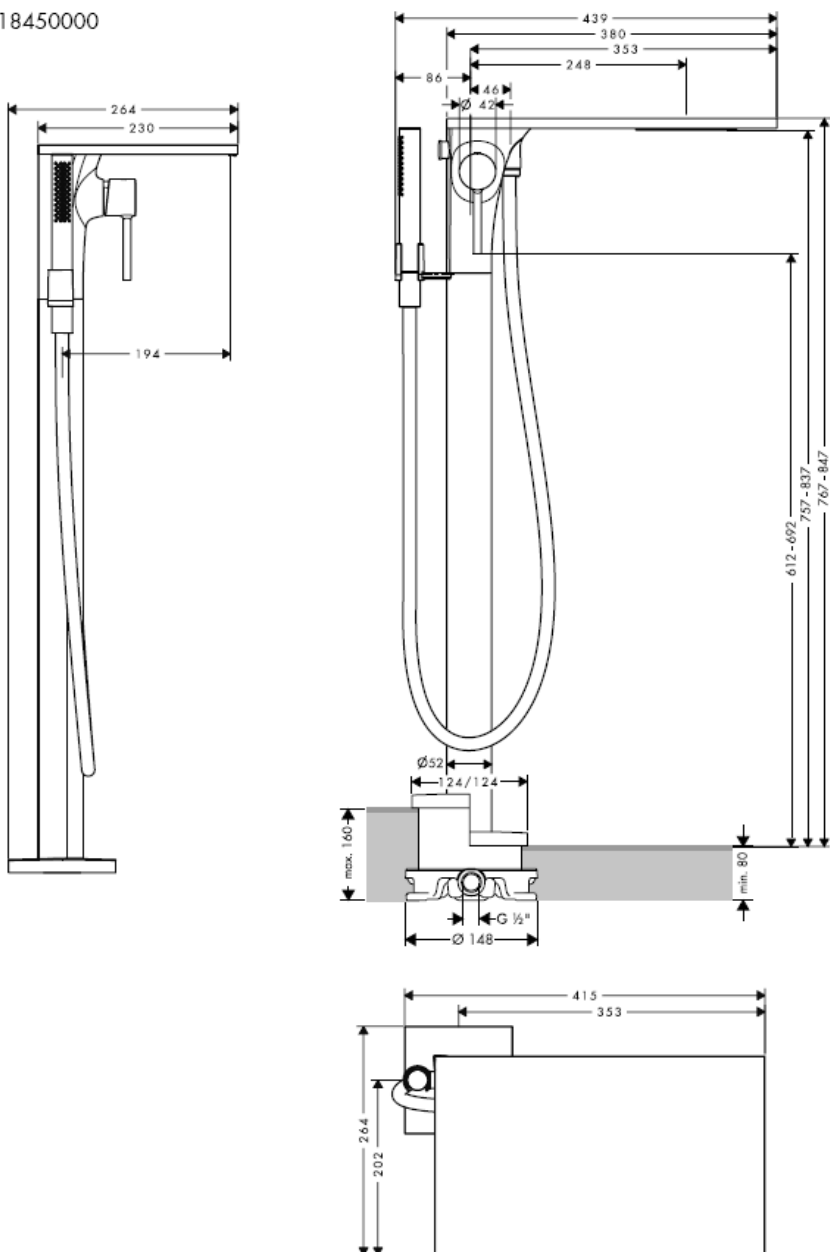

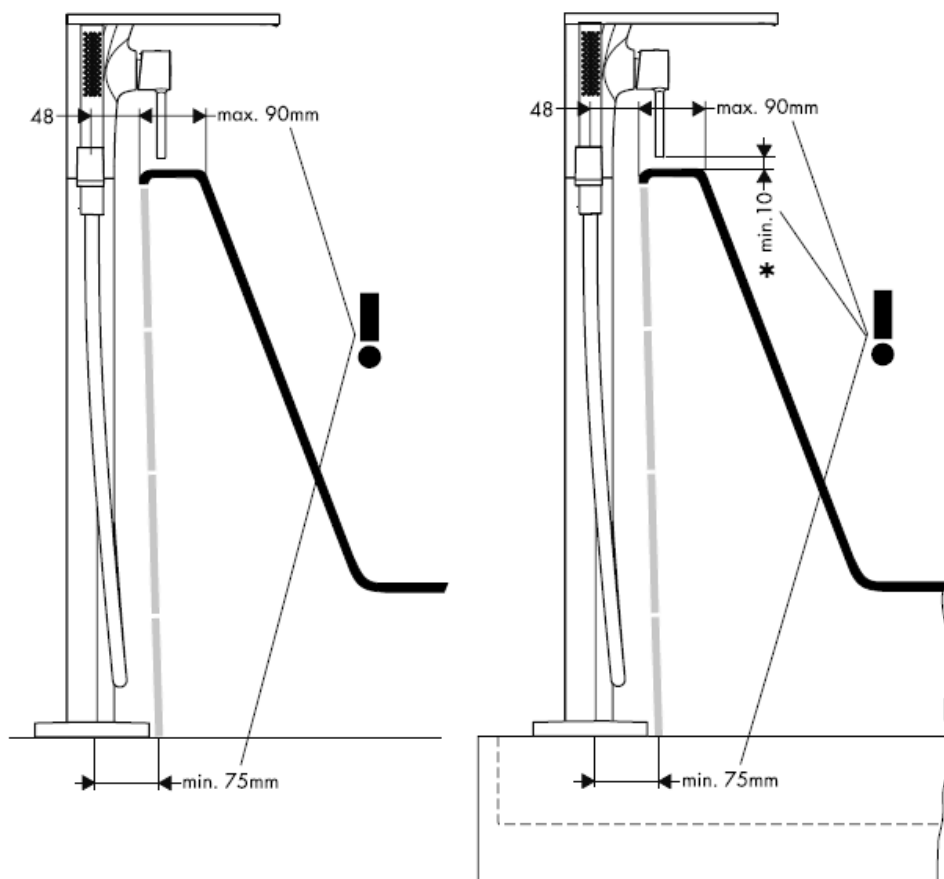

* < 10 min = 加长 (商品编号 97686000)

Citterio 39451000

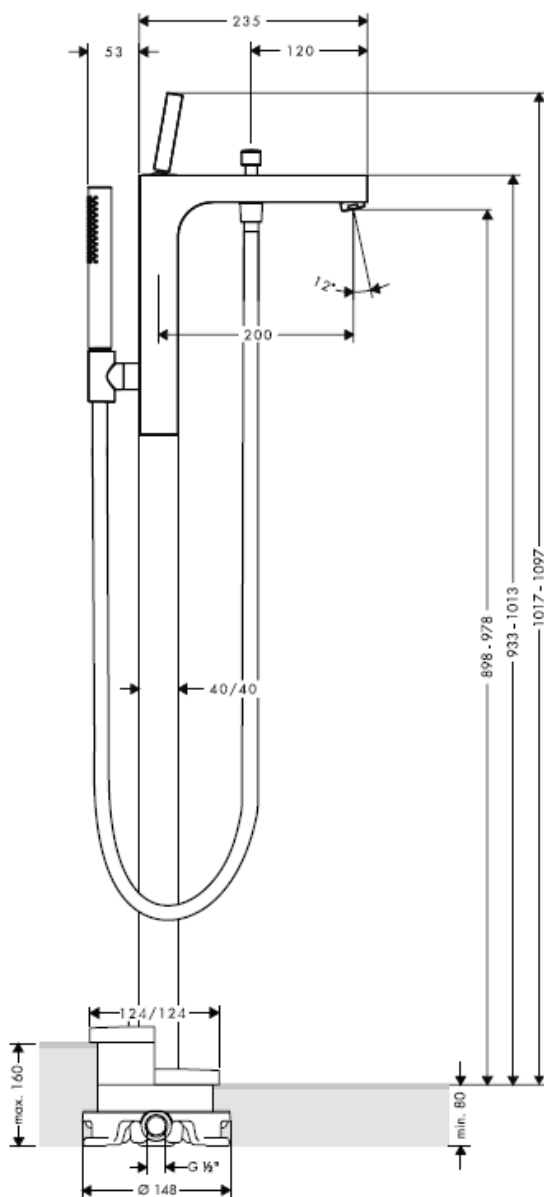

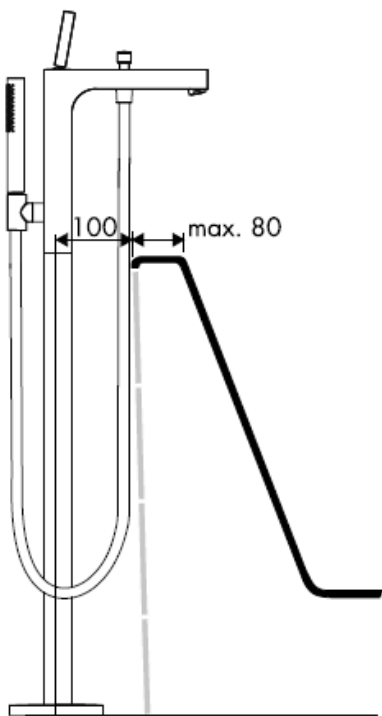

注意！
必须按照现行的规定安装，冲洗和测试产品！

Starck 10452180

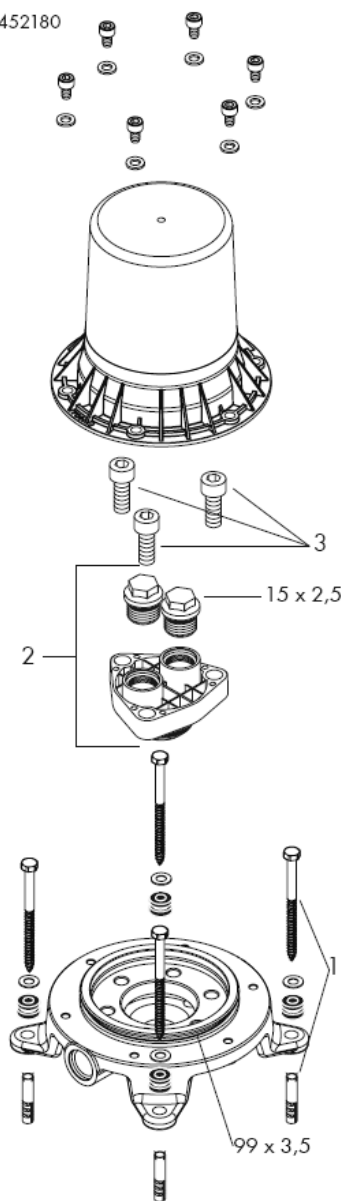

Montreux 16549180

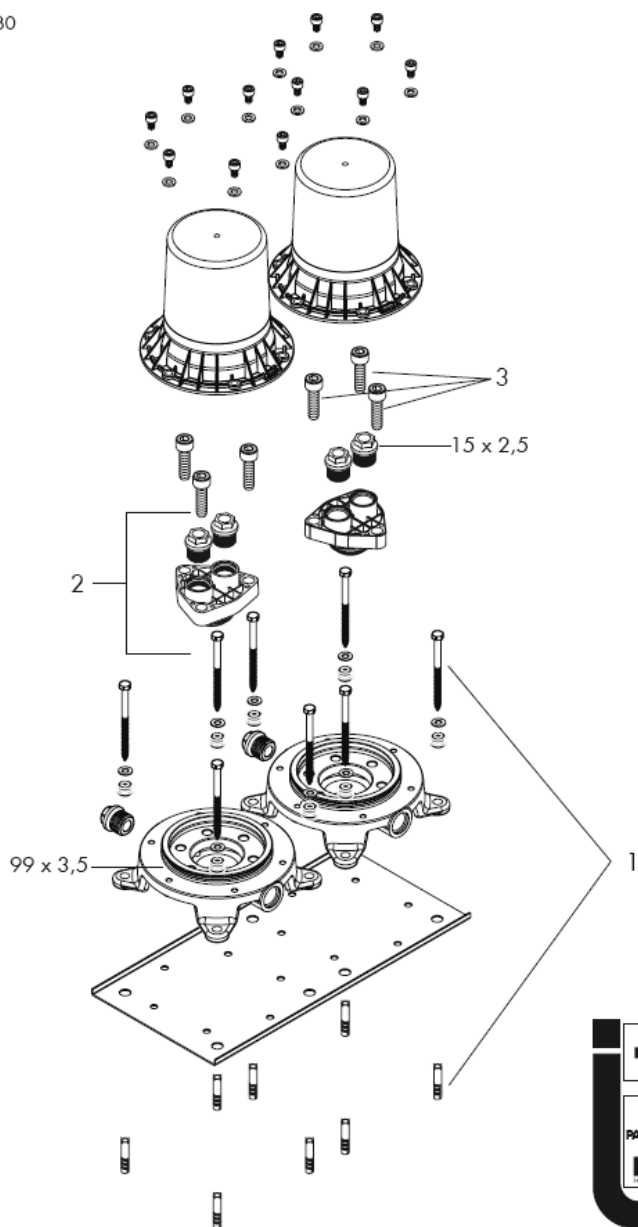

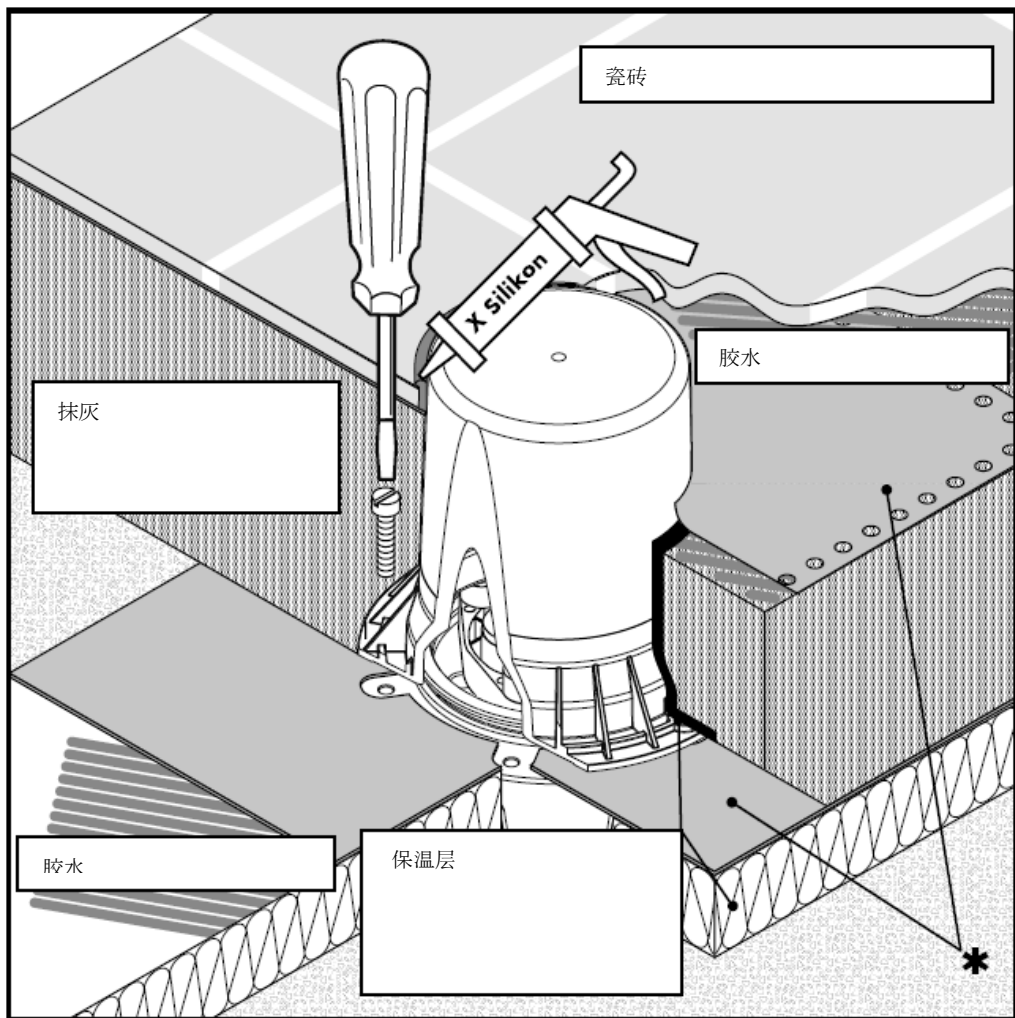

* 视需要，单独订购密封箱

X 硅胶（不含醋酸）

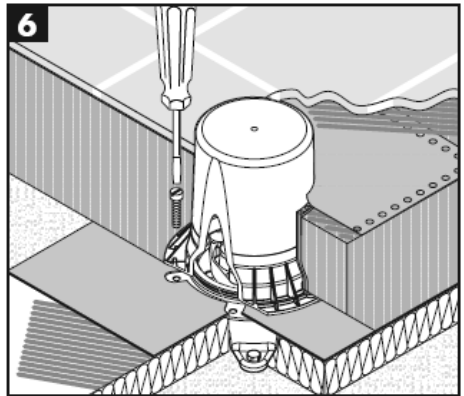
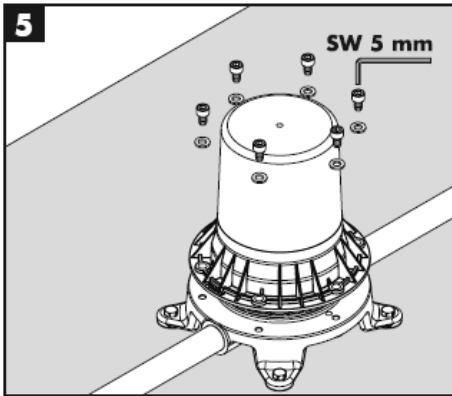
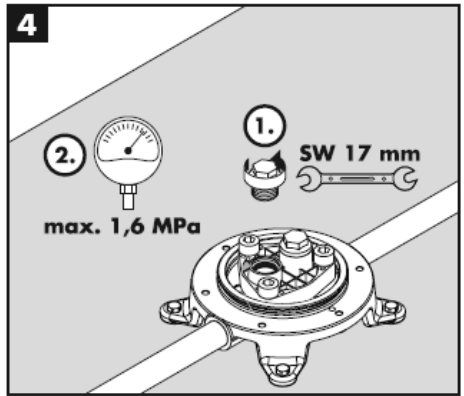
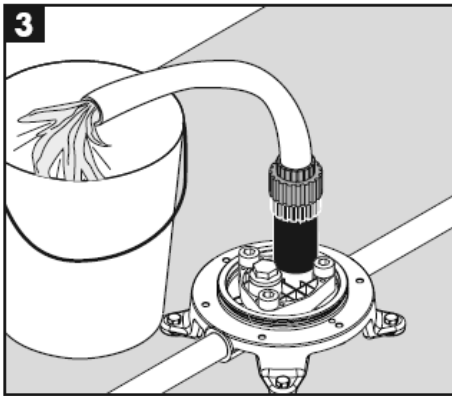
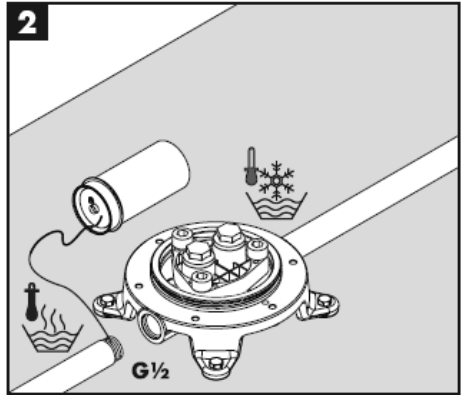
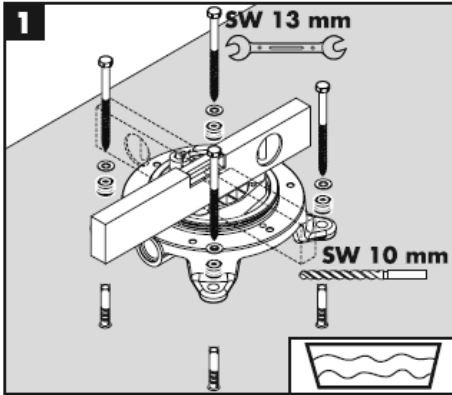

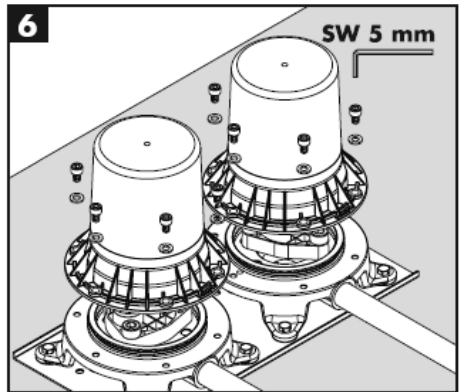
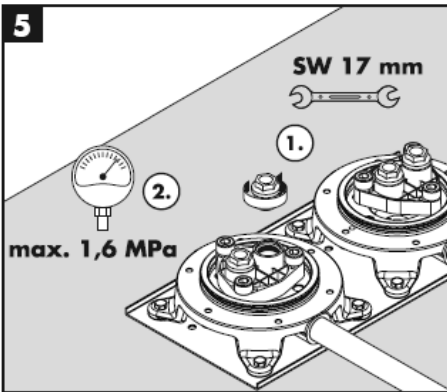
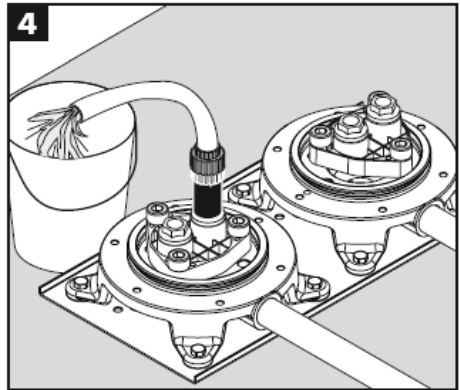
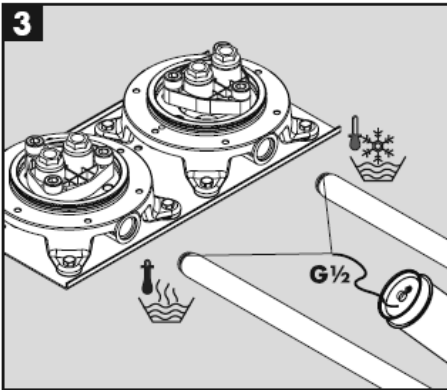
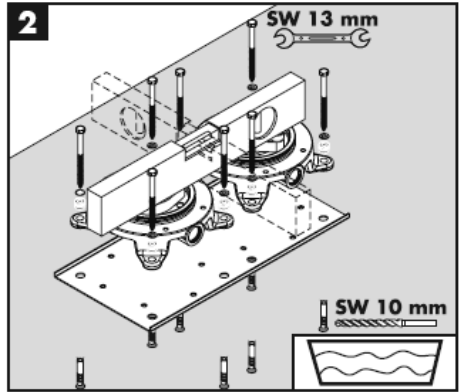
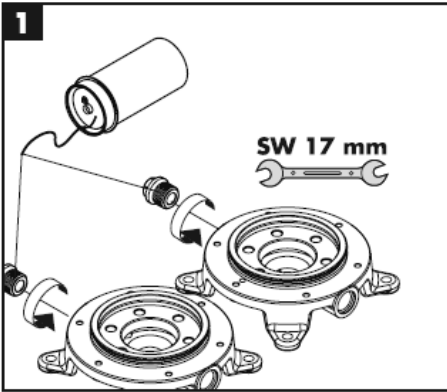

安装

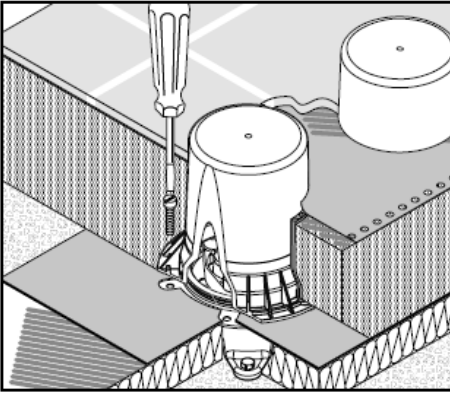

中文

技术参数

工作压强:	max. 1 MPa
推荐工作压强:	0,1 – 0,5 MPa
测试压强:	1,6 MPa
(1 MPa = 10 bar = 147 PSI)	
热水温度:	max. 80° C
推荐热水温度:	65° C

备用零件 参见第页 10 – 11

安装套件	96260000
密封垫圈	96459000
六角形凹头螺钉 M 10 x 35	97670000

选装附件

* 密封箔 (不在供货范围内)	96441000
--------------------	----------

检验标记

	DVGW	P-IX	SVGW	ACS	NF	WRAS	KIWA
10452180				x		X	
16549180		PA-IX 18729/ICB					

hansgrohe

Инструкция по монтажу

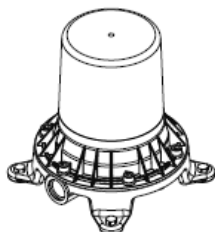

Starck
10452180

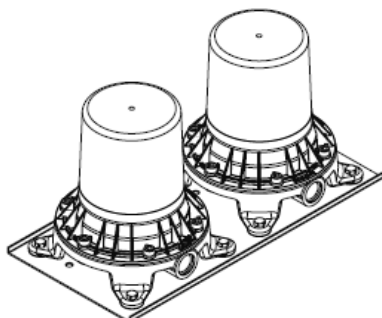

Montreux
16549180

AXOR[®]

hansgrohe

Starck 10458XXX

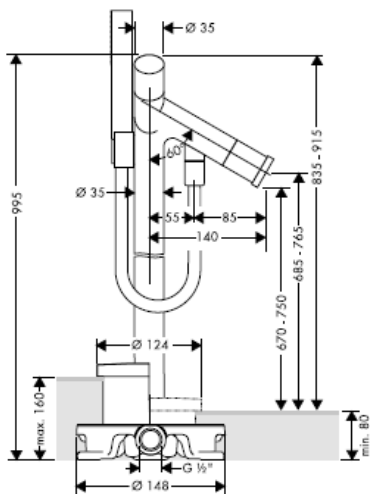

Starck 10060XXX

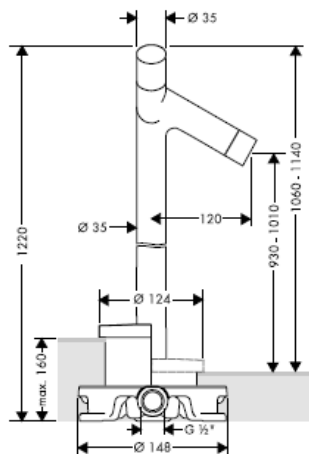

Starck 10456XXX

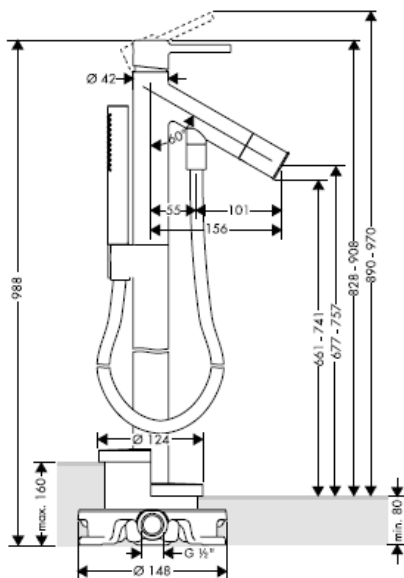



**HOESCH
Philippe Starck
Edition II**

Отдельно стоящая ванна с внешней обшивкой.

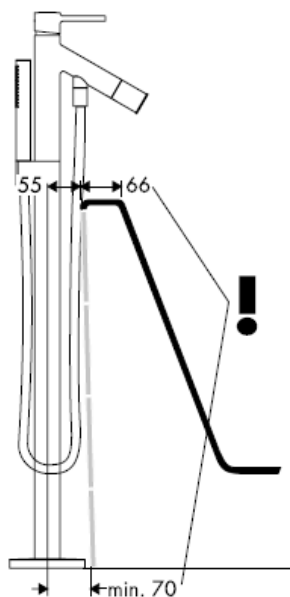

**HOESCH
Philippe Starck
Edition II**

Отдельно стоящая ванна с внешней обшивкой.



Starck X 10406000

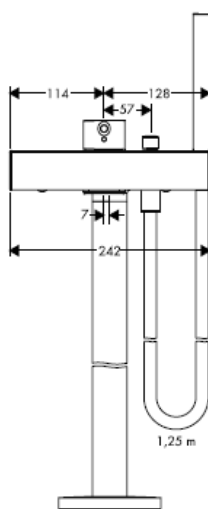
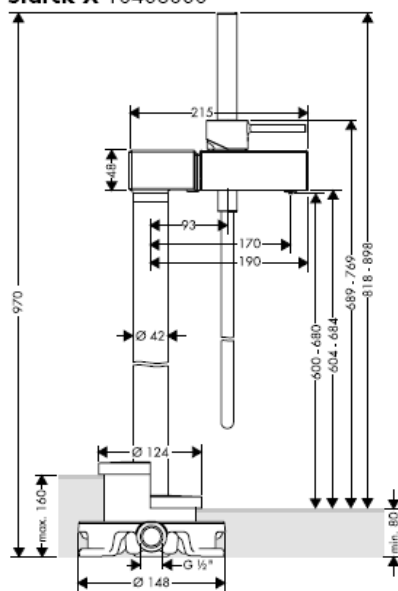

Montreux 16547XXX

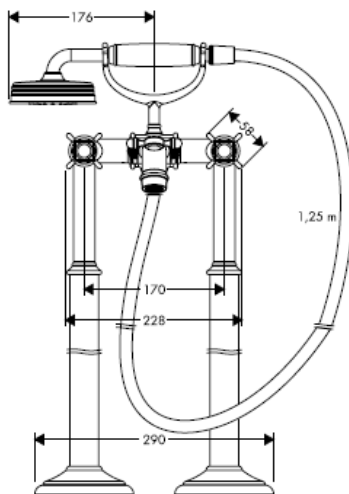
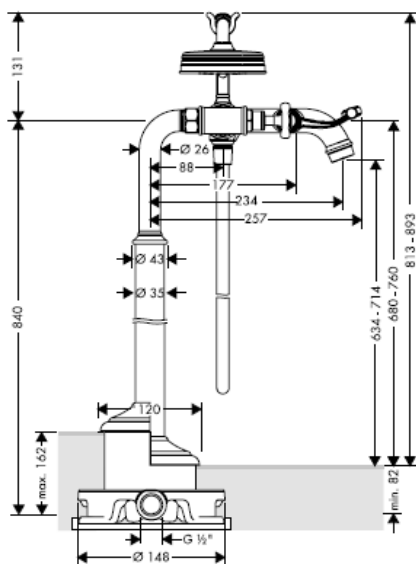

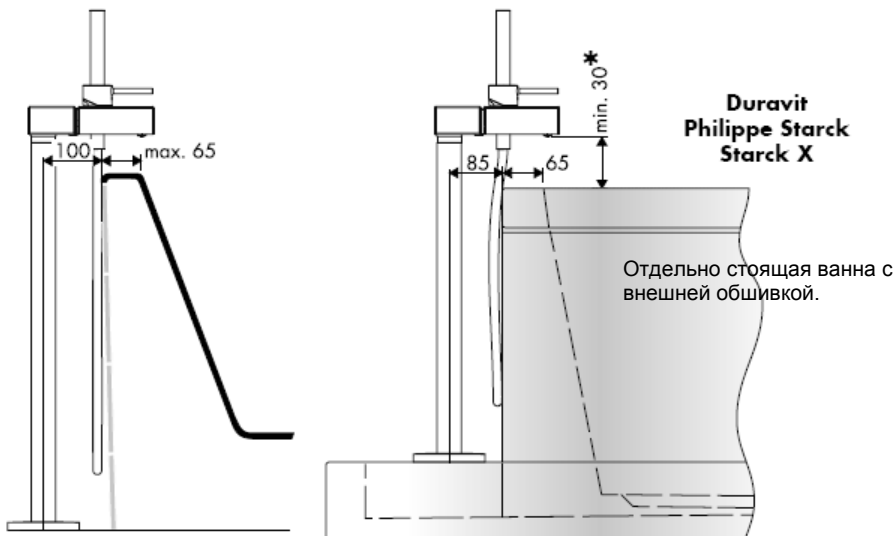

* < 30 min = Удлинение 60 мм (арт. № 97686000)



Massaud 18450000

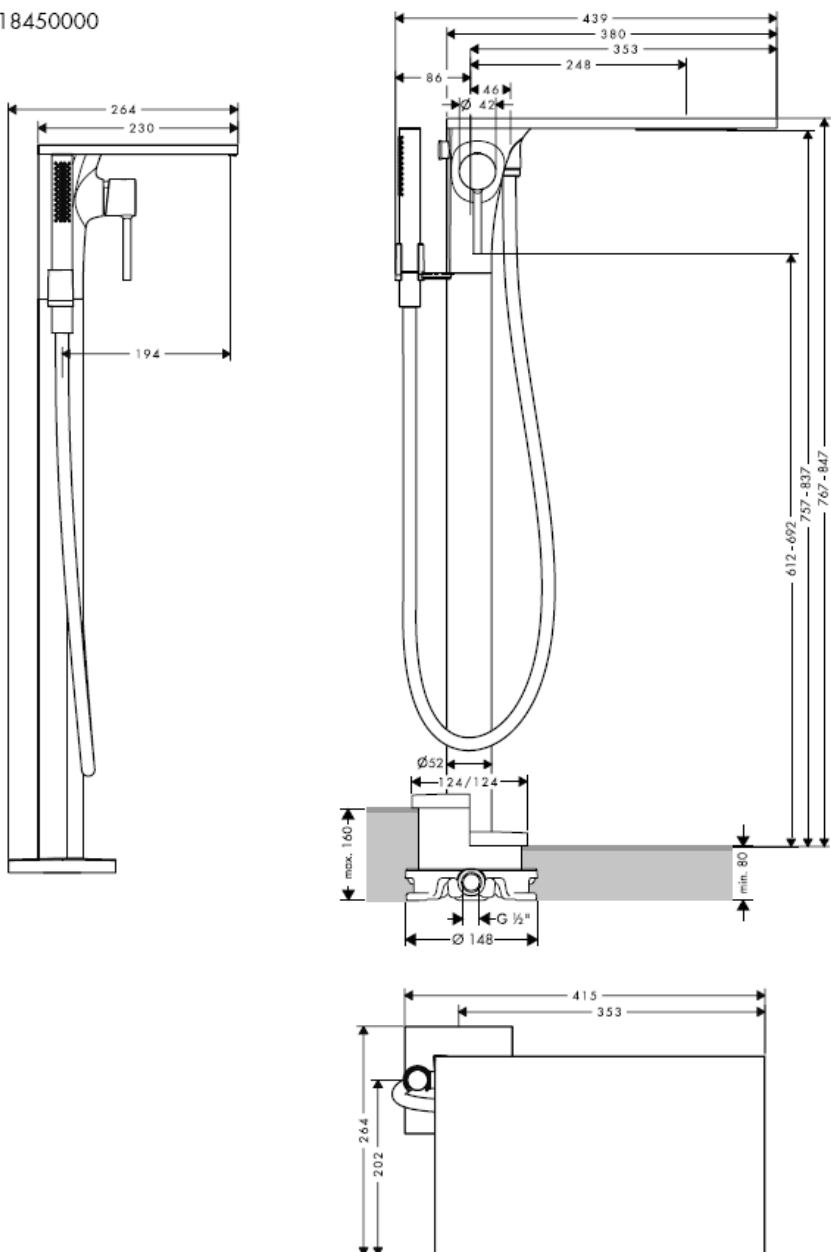

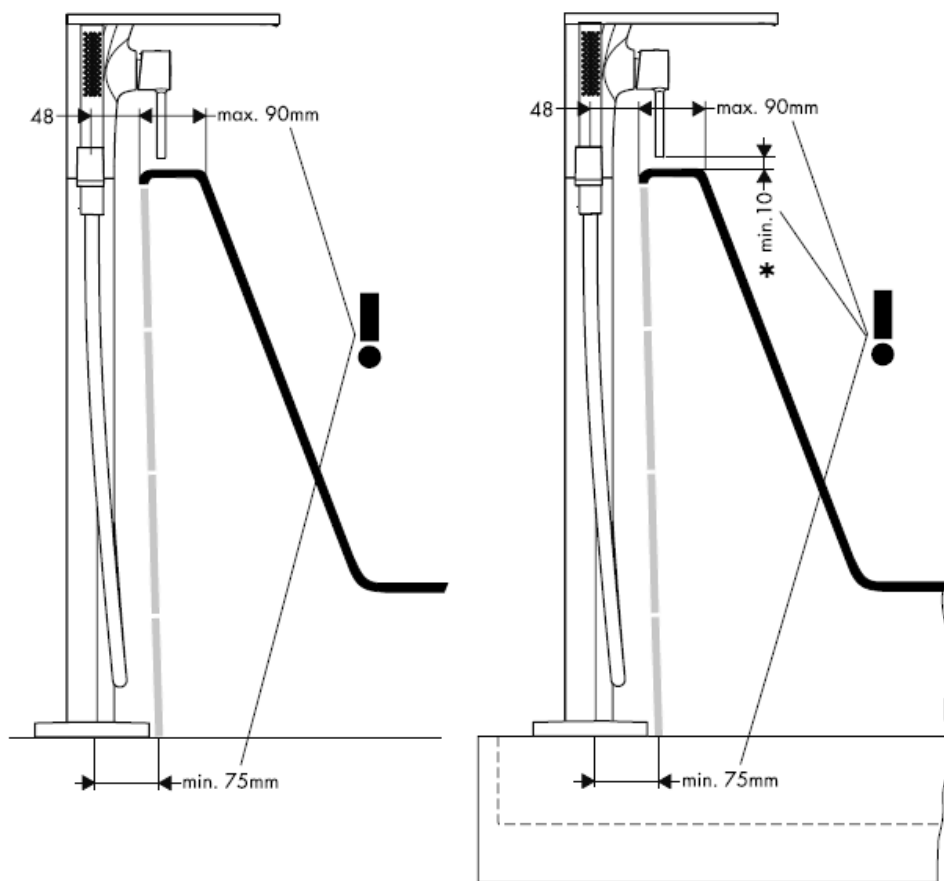

* < 10 min = Удлинение 60 мм (арт. № 97686000)

Citterio 39451000

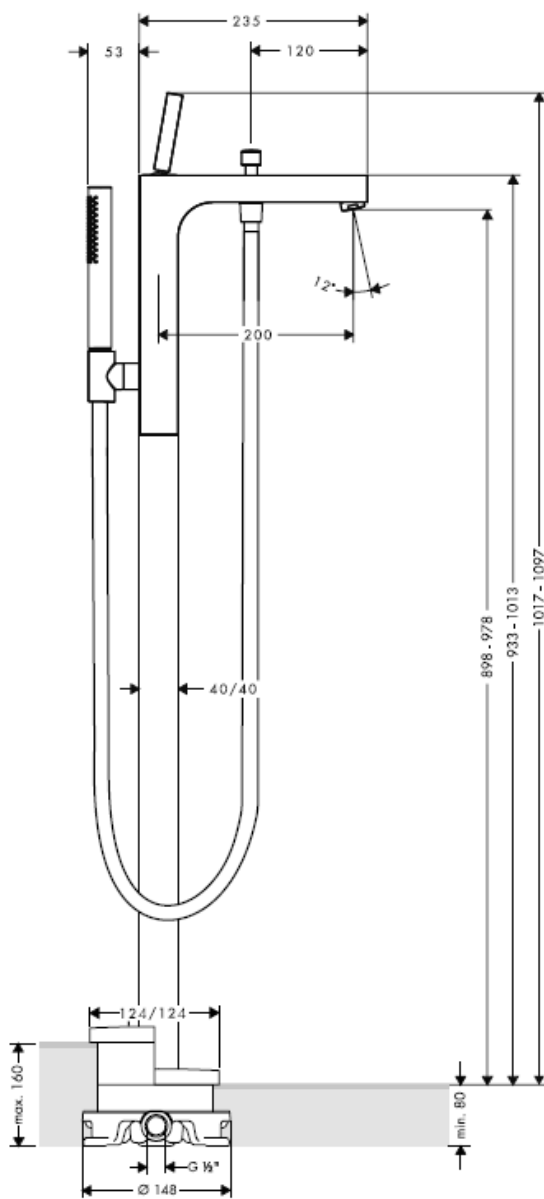

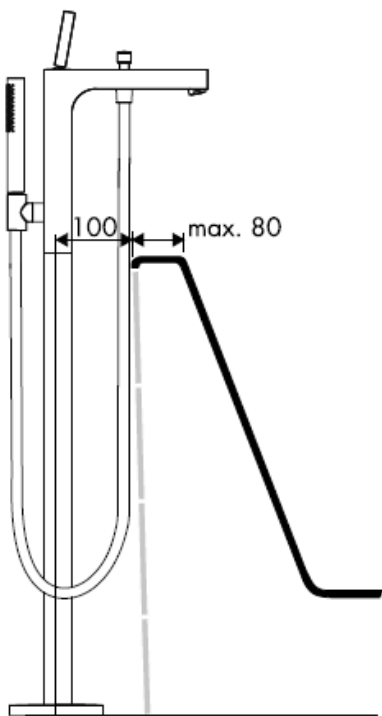

ВНИМАНИЕ! Смеситель должен быть смонтирован по действующим нормам и в соответствии с настоящей инструкцией, проверен на герметичность и безупречность работы

Starck 10452180

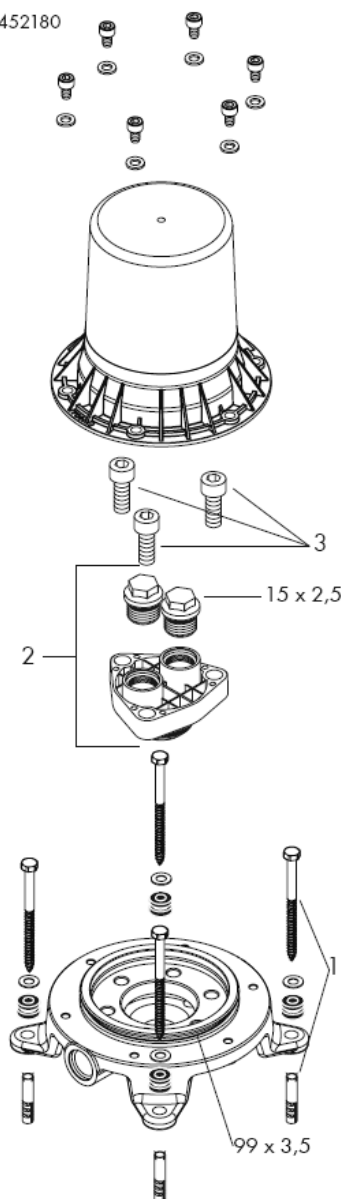

Montreux 16549180

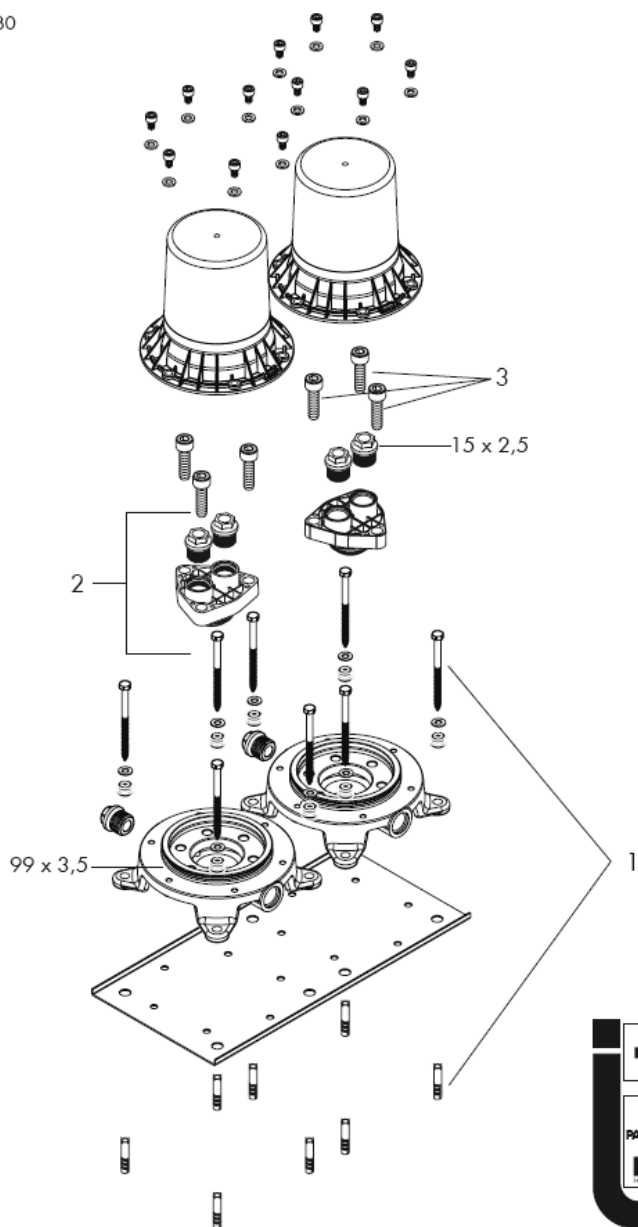

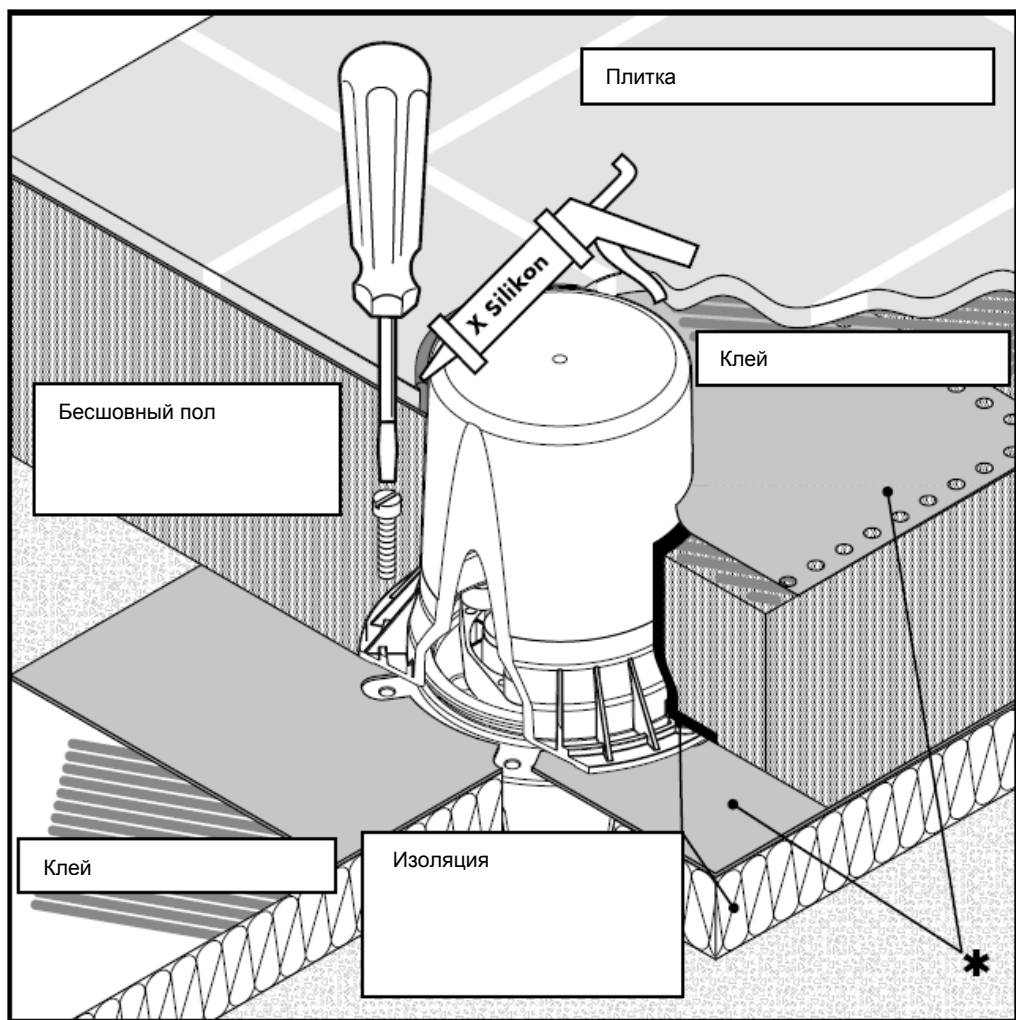

* манжета, предлагаемая

X Силикон (не содержит уксусной кислоты!)

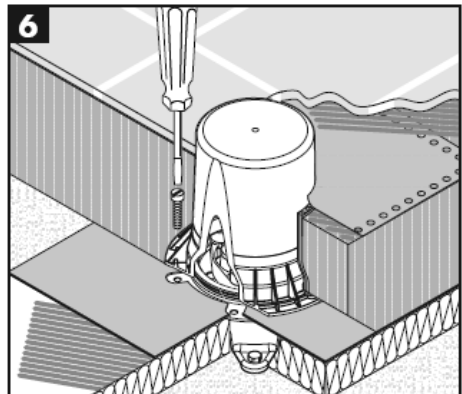
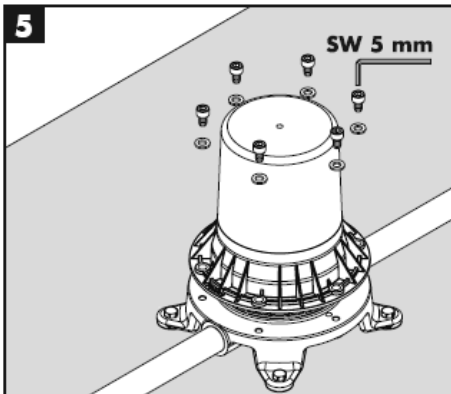
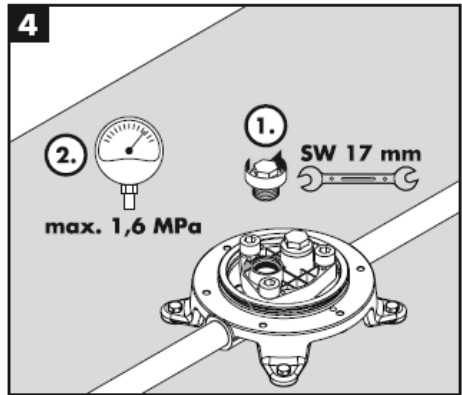
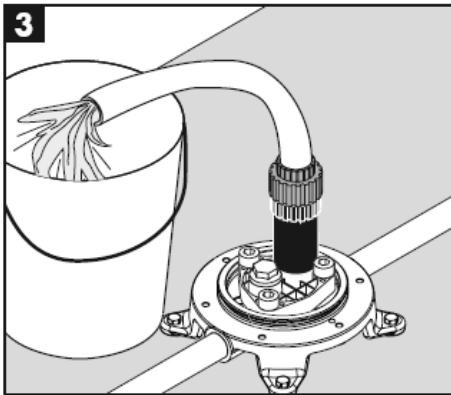
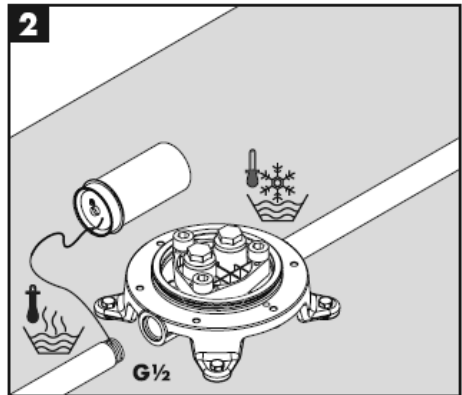
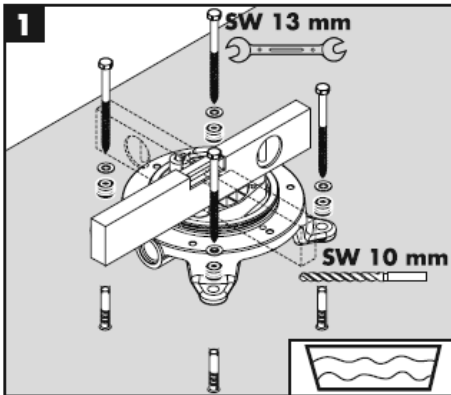

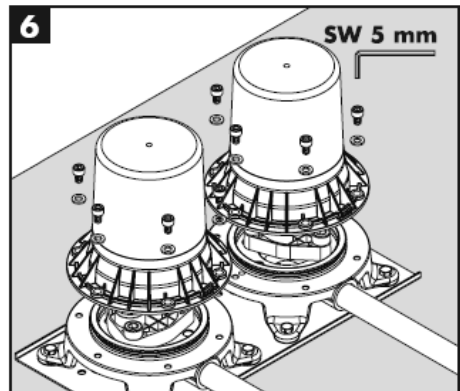
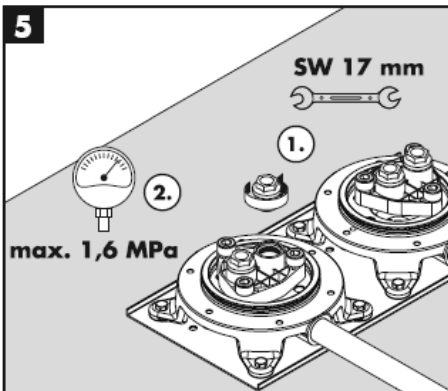
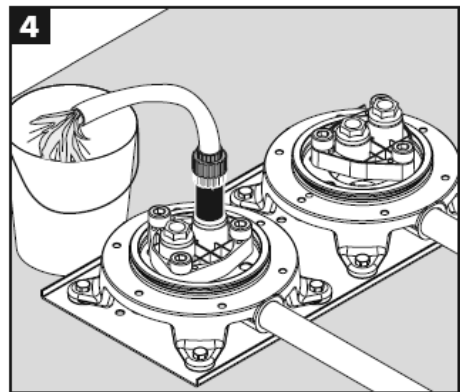
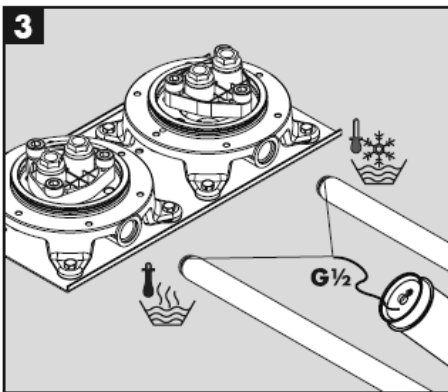
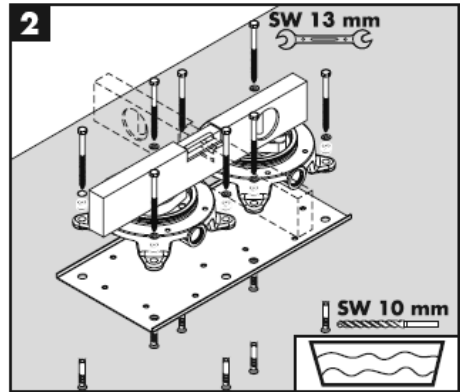
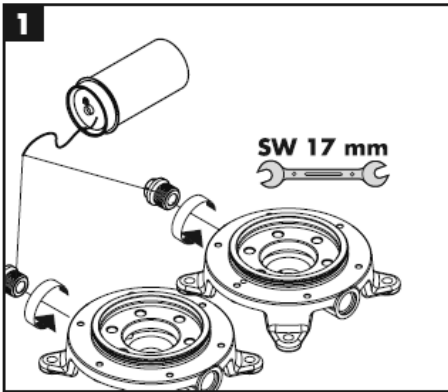

Монтаж

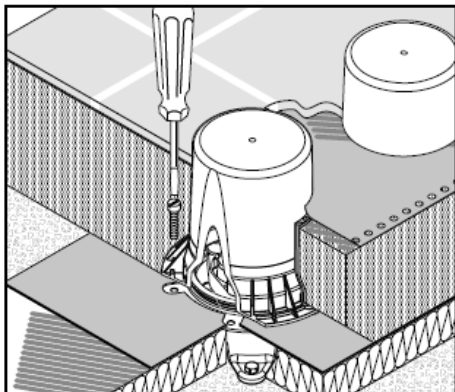

Русский

Технические данные

Рабочее давление: max. 1 МПа
 Рекомендуемое рабочее давление: 0,1 – 0,5 МПа
 Давление: 1,6 МПа
 (1 МПа = 10 bar = 147 PSI)
 Температура горячей воды: max. 80° C
 Рекомендуемая темп. гор. воды: 65° C

Комплект см. стр. 10 – 11

крепежный набор 96260000
 Уплотнительный комплект 96459000
 Винт с цилиндрической головкой M 10 x 35 97670000

Специальные принадлежности

* Уплотнительная манжета 96441000
 (не включено в объем поставки!)

Знак технического контроля

	DVGW	P-IX	SVGW	ACS	NF	WRAS	KIWA
10452180				x		X	
16549180		PA-IX 18729/ICB					

hansgrohe

Szerelési útmutató

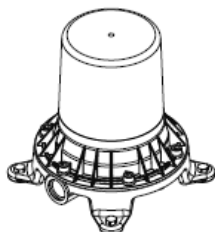

Starck
10452180

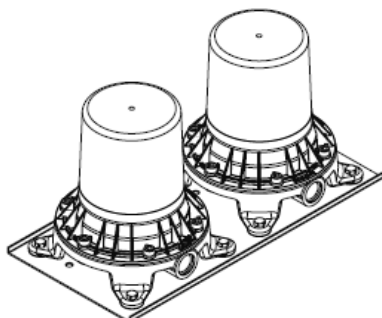

Montreux
16549180

AXOR[®]

hansgrohe

Starck 10458XXX

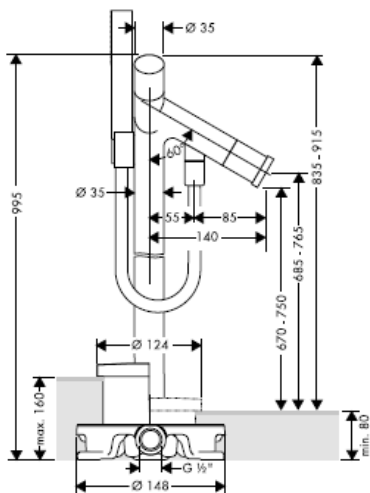

Starck 10060XXX

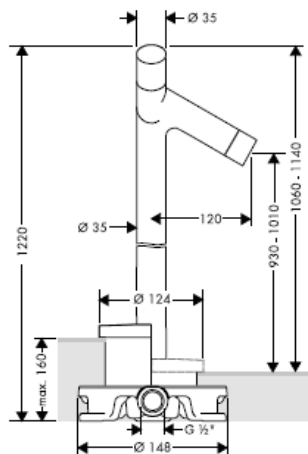

Starck 10456XXX

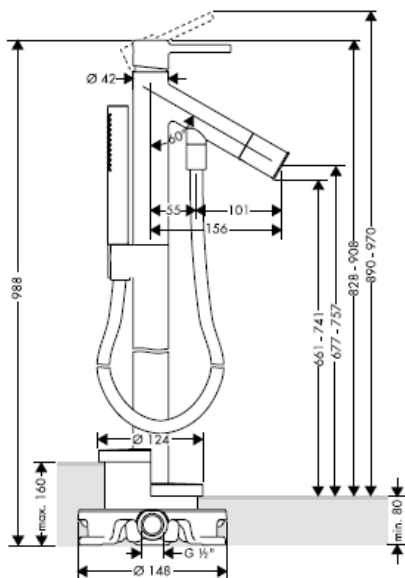

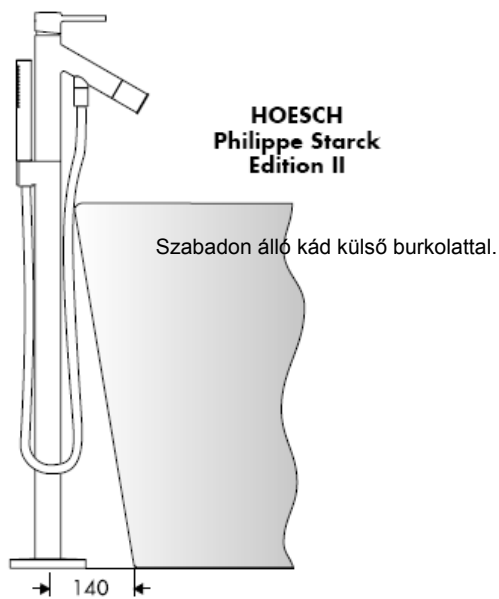
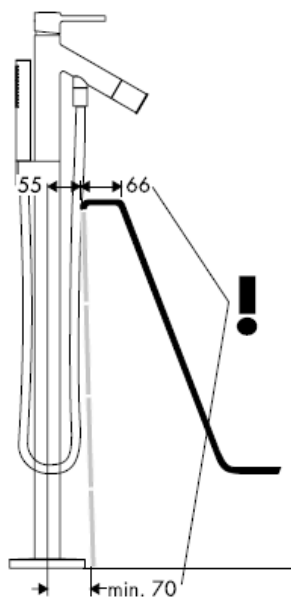
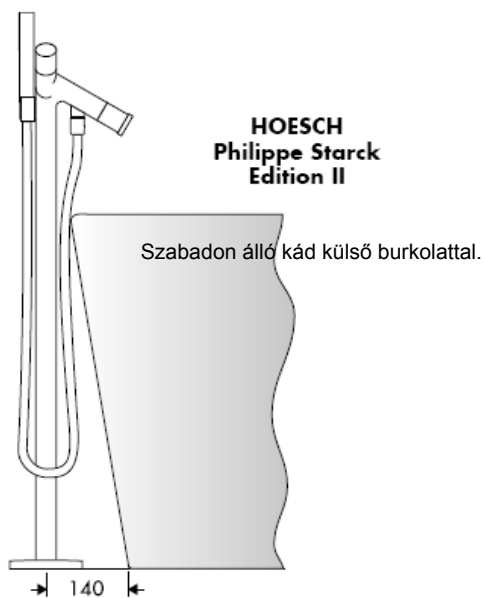

Starck X 10406000

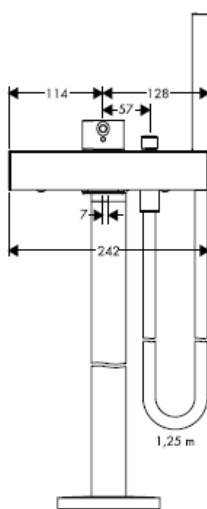
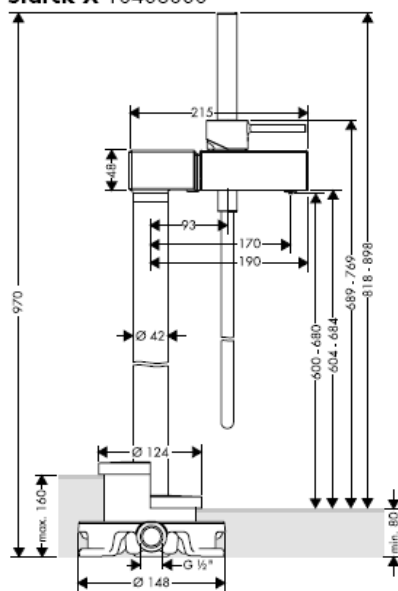

Montreux 16547XXX

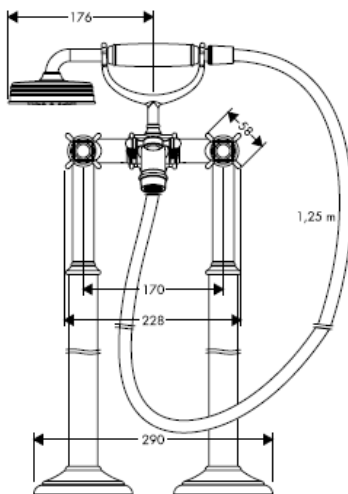
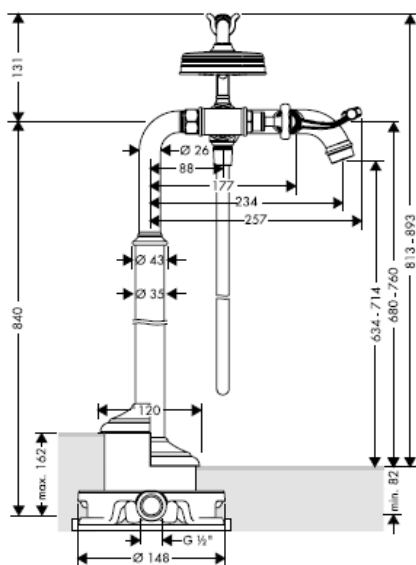

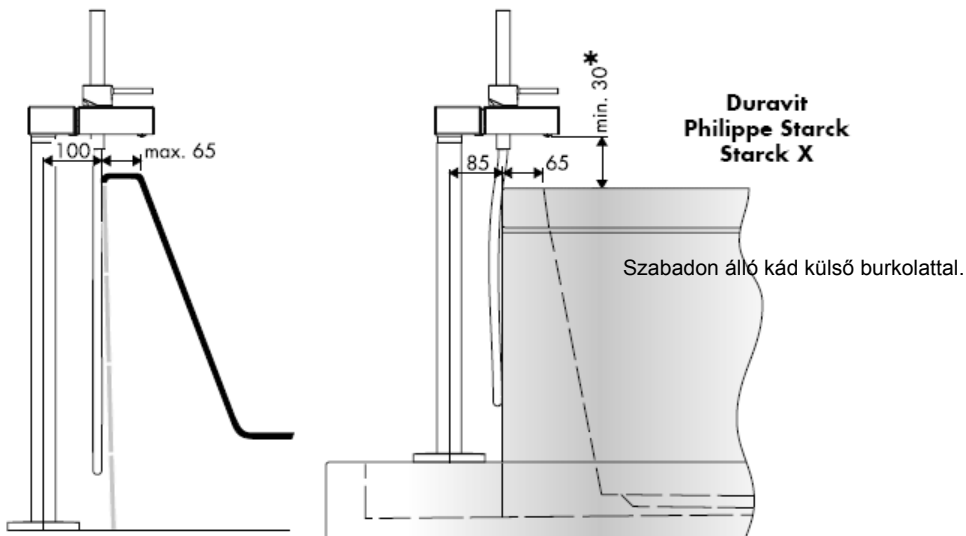

* < 30 min = Hosszabbítás 60 mm (cikkszám 97686000)



Massaud 18450000

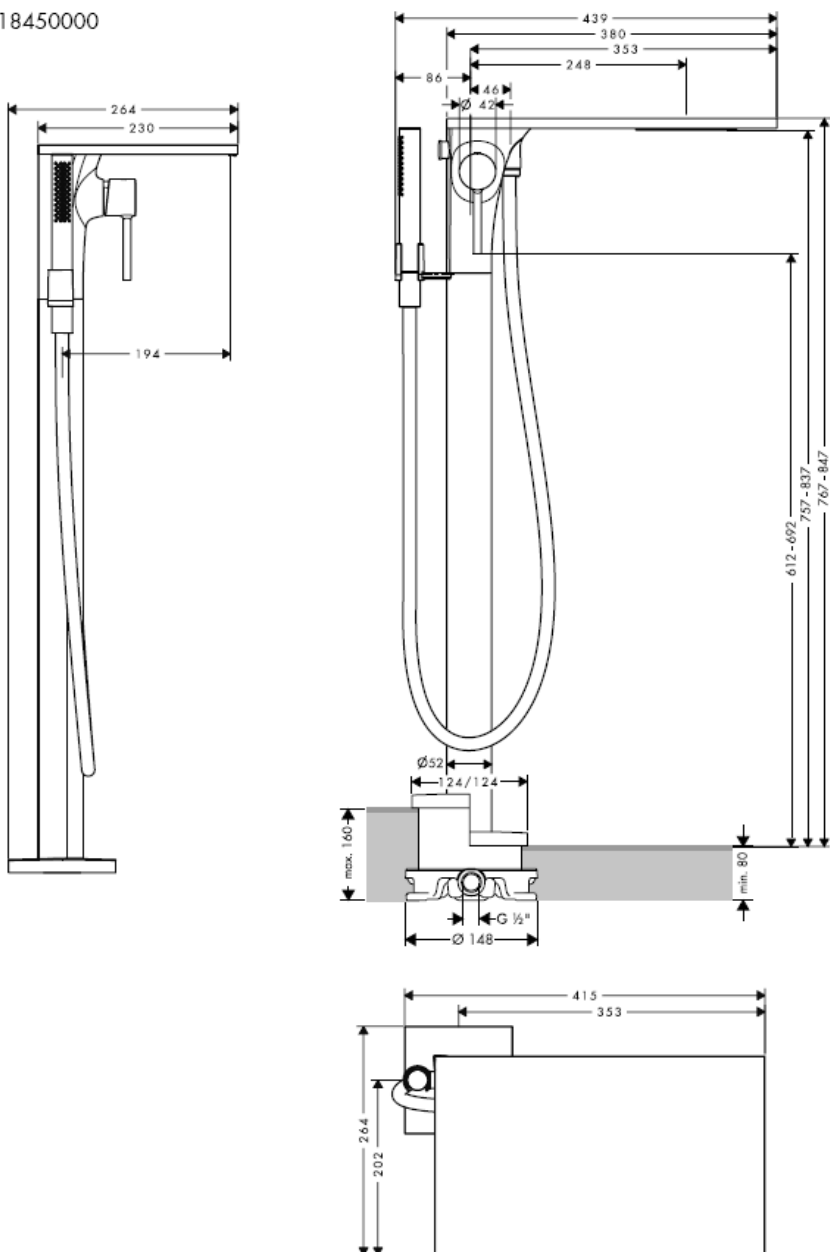

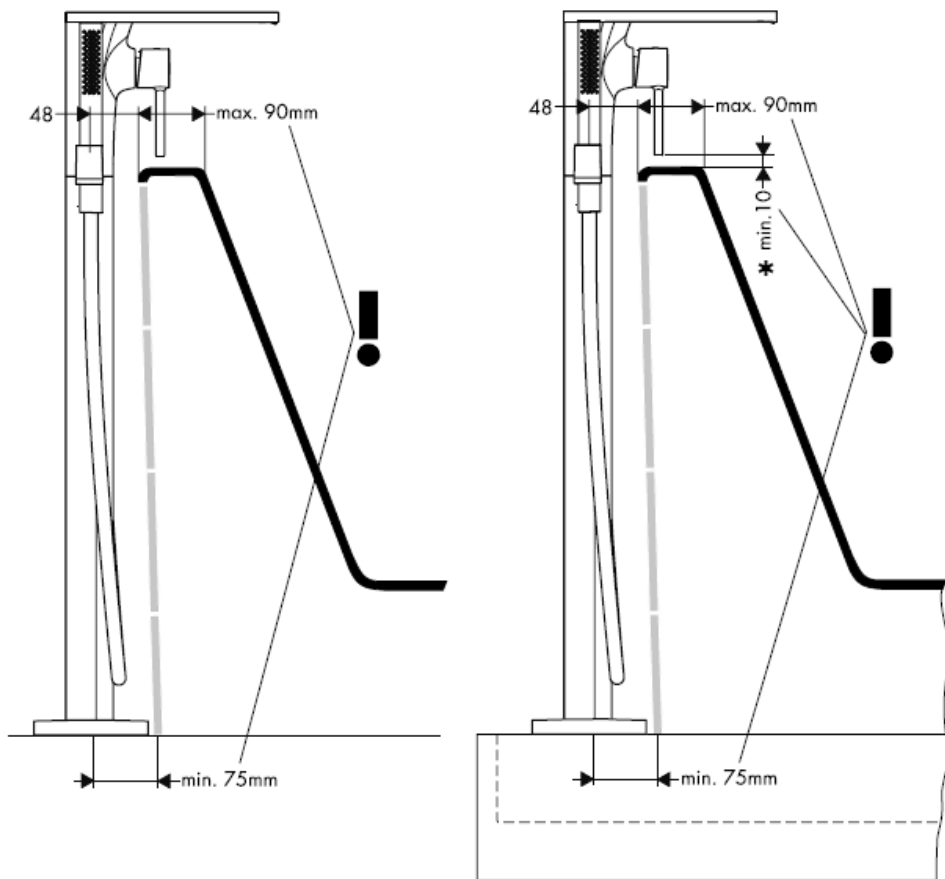

* < 10 min = Hosszabbítás 60 mm (cikkszám 97686000)

Citterio 39451000

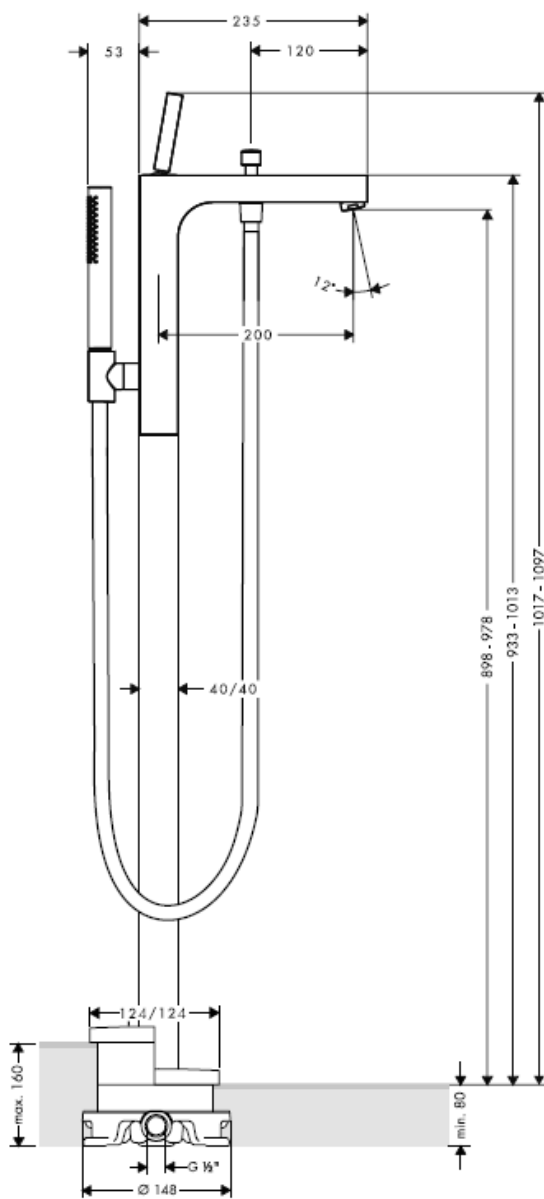

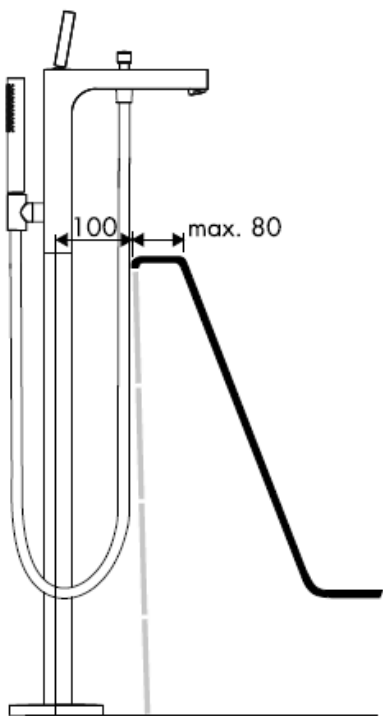

Figyelem! A csaptelepet az érvényben lévő előírásoknak megfelelően kell felszerelni, átöblíteni és ellenőrizni!

Starck 10452180

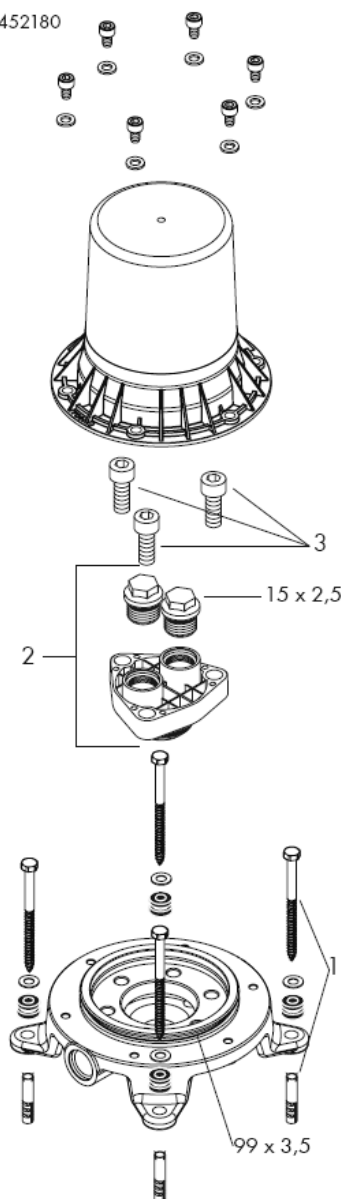

Montreux 16549180

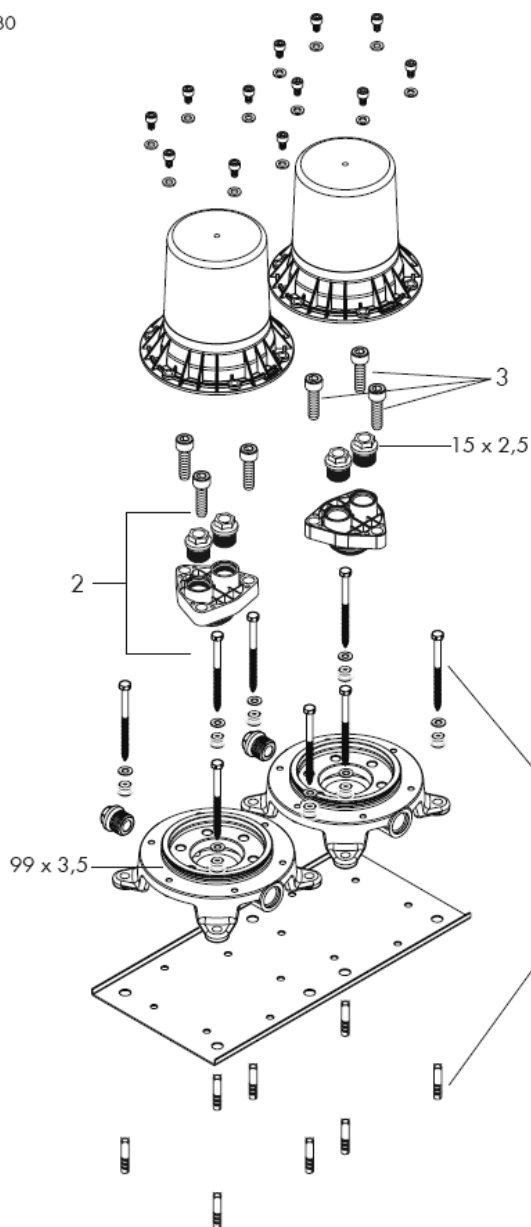

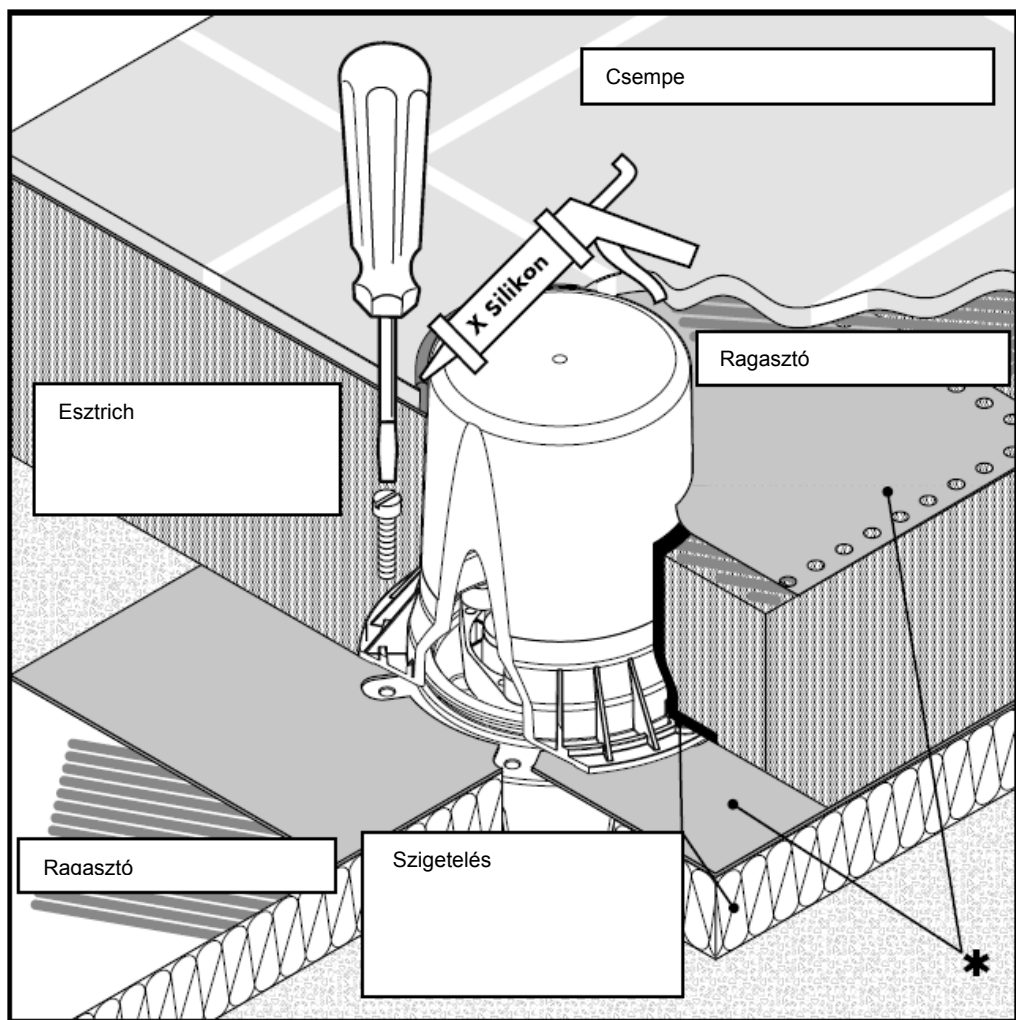

* opcionálisan kapható tömítőkarima

X Szilikon (ecetsavmentes!)

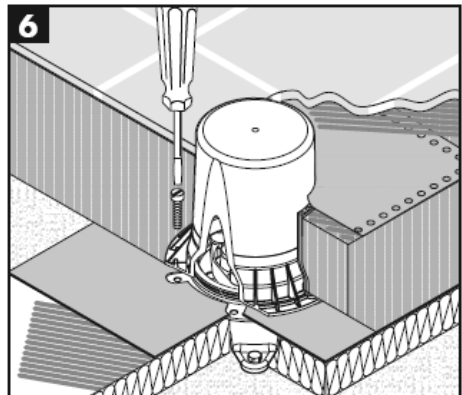
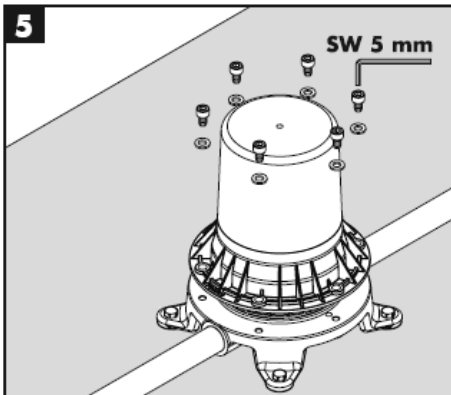
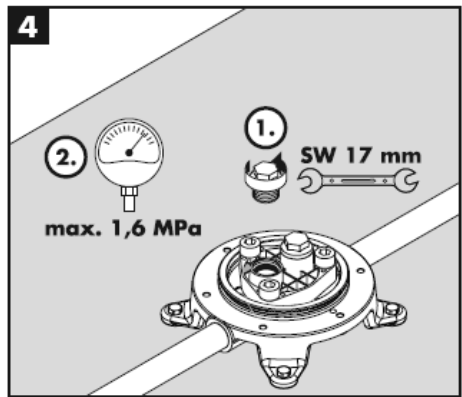
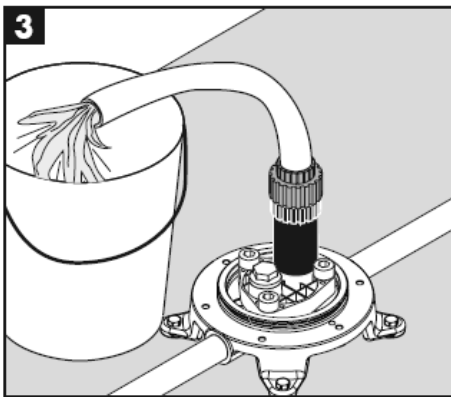
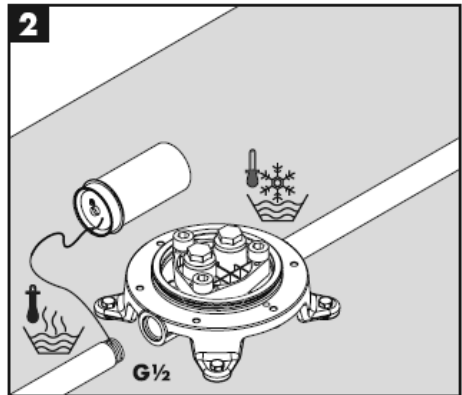
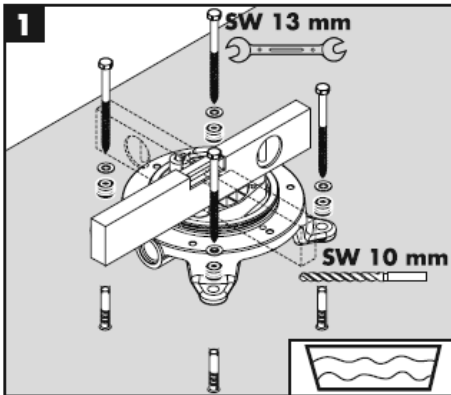

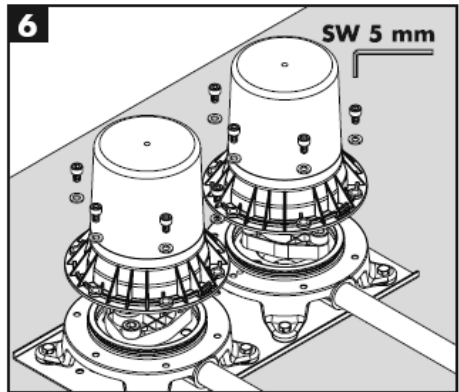
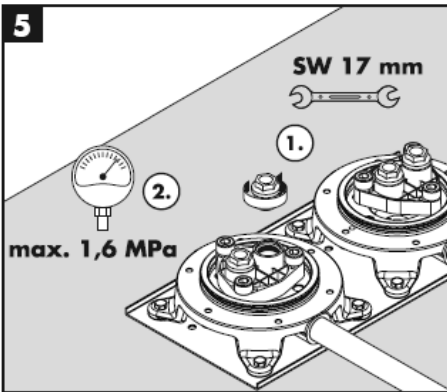
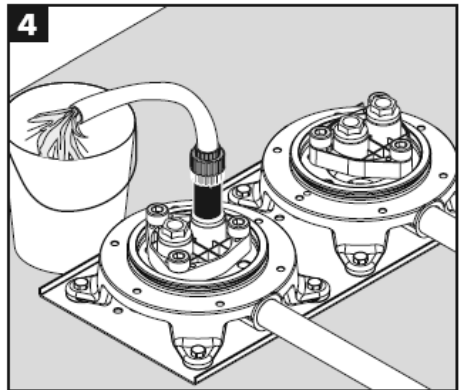
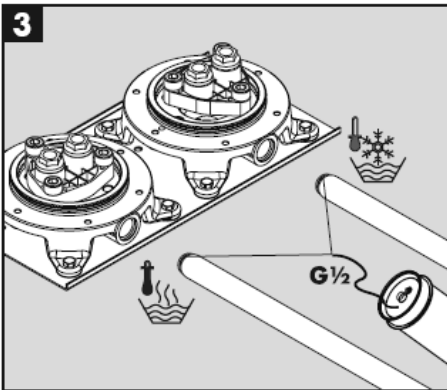
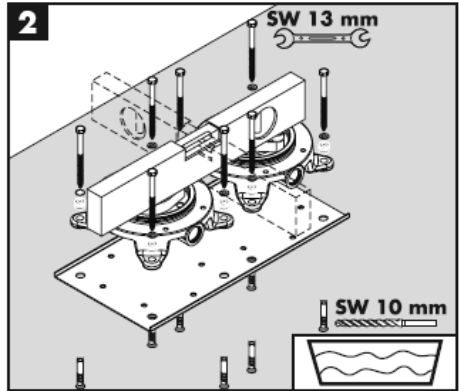
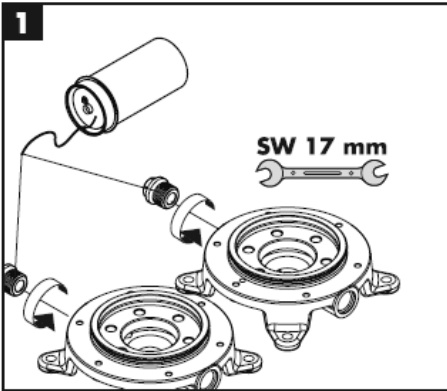

Szerelés

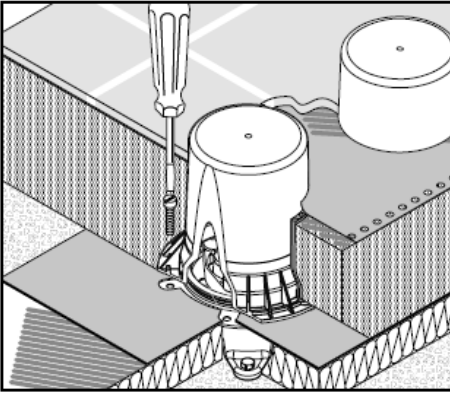

Magyar

Műszaki adatok

Üzemi nyomás:	max. 1 MPa
Ajánlott üzemi nyomás:	0,1 – 0,5 MPa
Nyomáspróba: (1 MPa = 10 bar = 147 PSI)	1,6 MPa
Forróvíz hőmérséklet:	max. 80° C
Forróvíz javasolt hőmérséklete:	65° C

Tartozékok lásd a oldalon 10 – 11

Rögzítő felület	96260000
Tömítőszett	96459000
Hengercsavar M 10 x 35	97670000

Egyéb tartozék

* Tömítőkarima (a szállítási egység nem tartalmazza)	96441000
---	----------

Vizsgajel

	DVGW	P-IX	SVGW	ACS	NF	WRAS	KIWA
10452180				x		X	
16549180		PA-IX 18729/ICB					

hansgrohe

Asennusohje

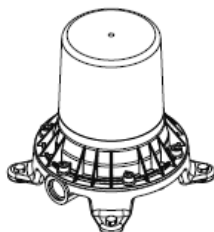

Starck
10452180

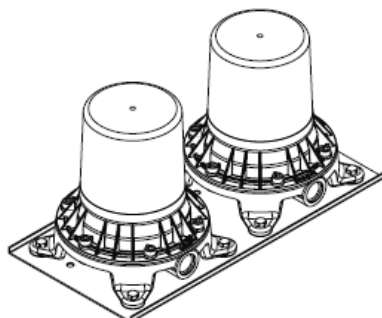

Montreux
16549180

AXOR[®]

hansgrohe

Starck 10458XXX

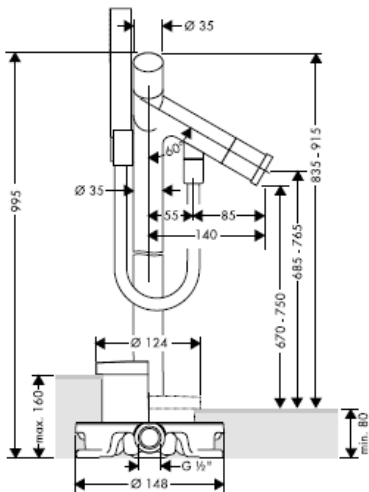

Starck 10060XXX

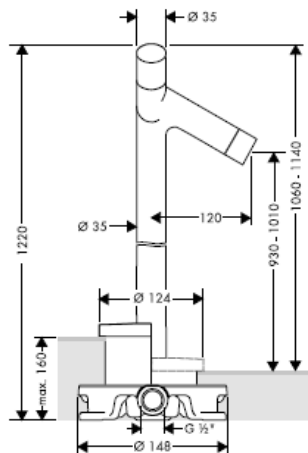

Starck 10456XXX

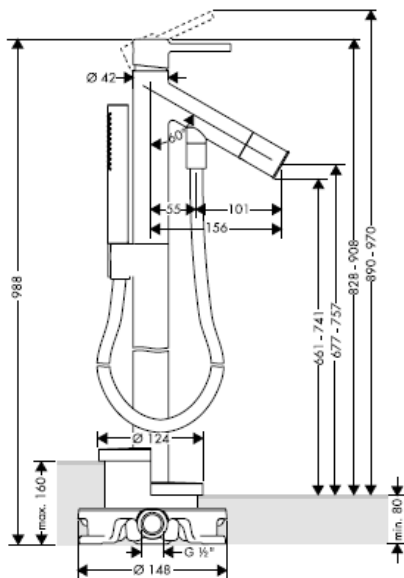

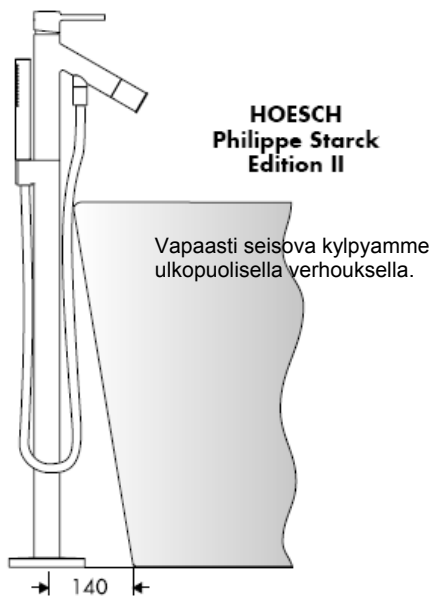
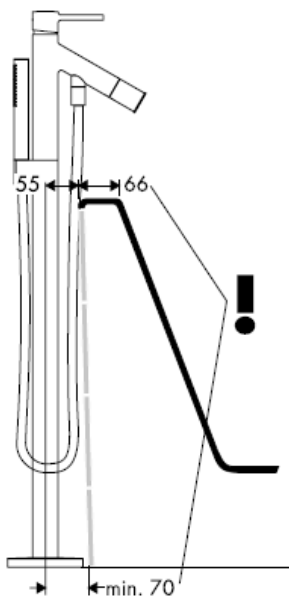
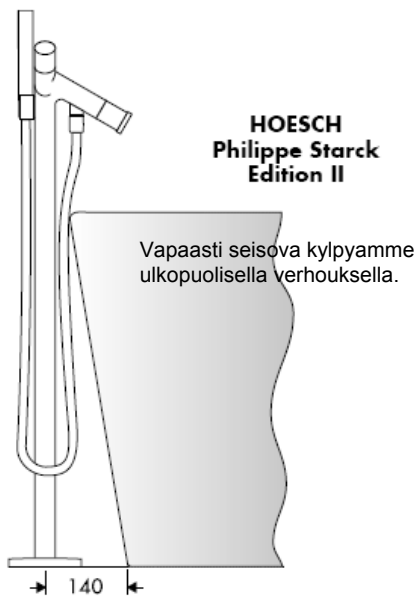
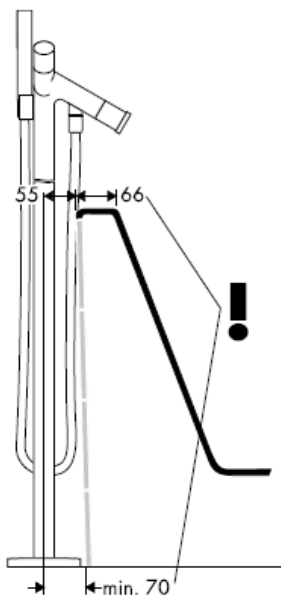

Starck X 10406000

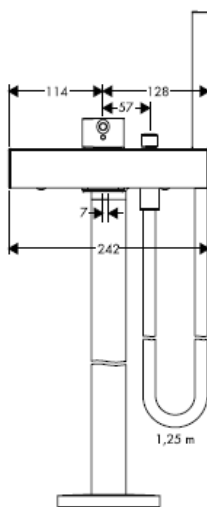
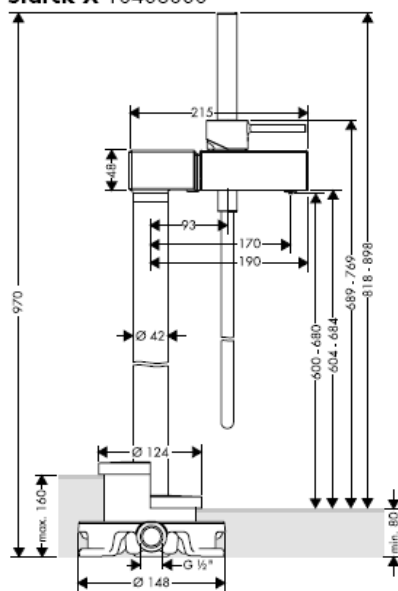

Montreux 16547XXX

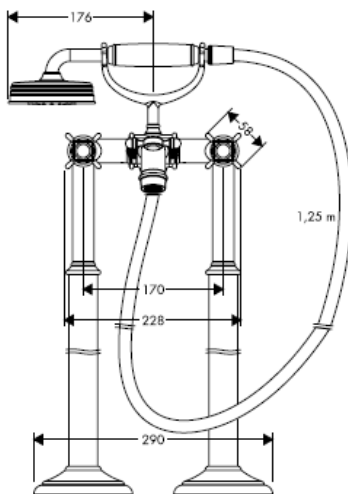
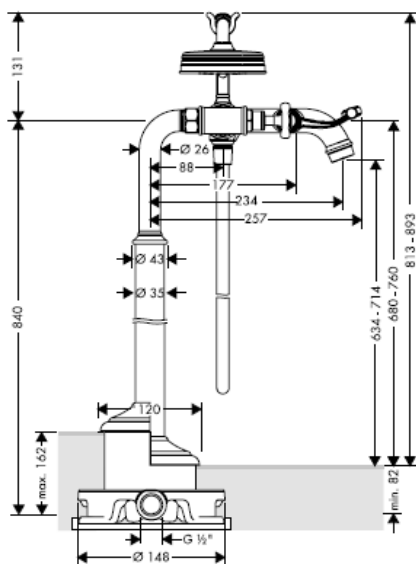

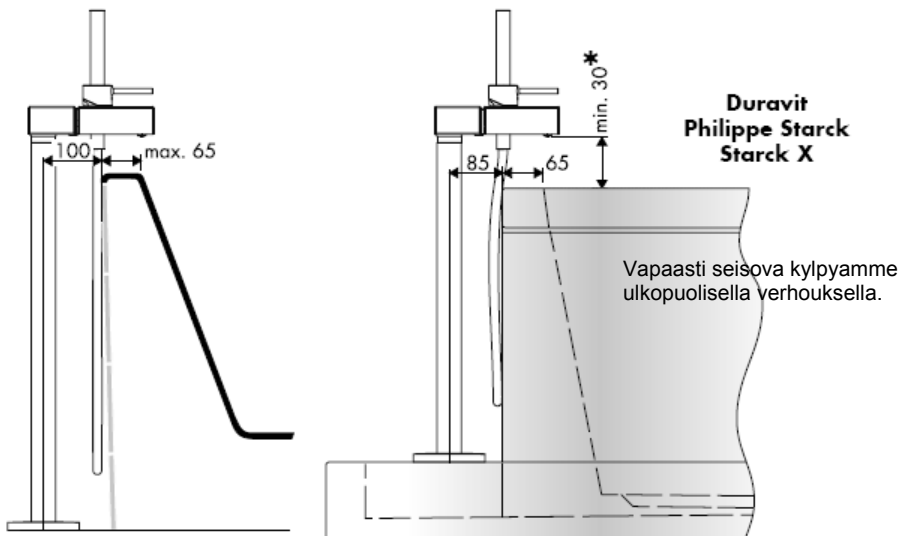

* < 30 min = Pidennys 60 mm (tuotenumero 97686000)



Massaud 18450000

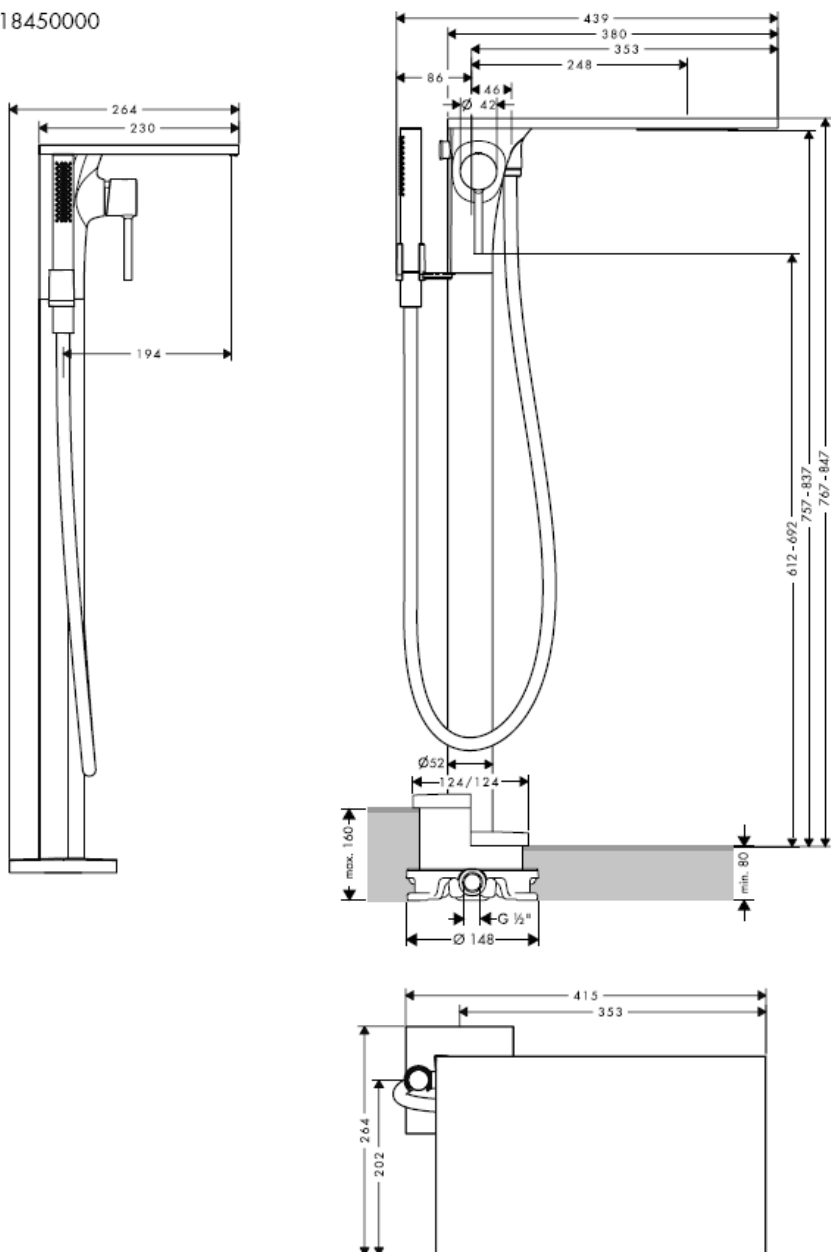

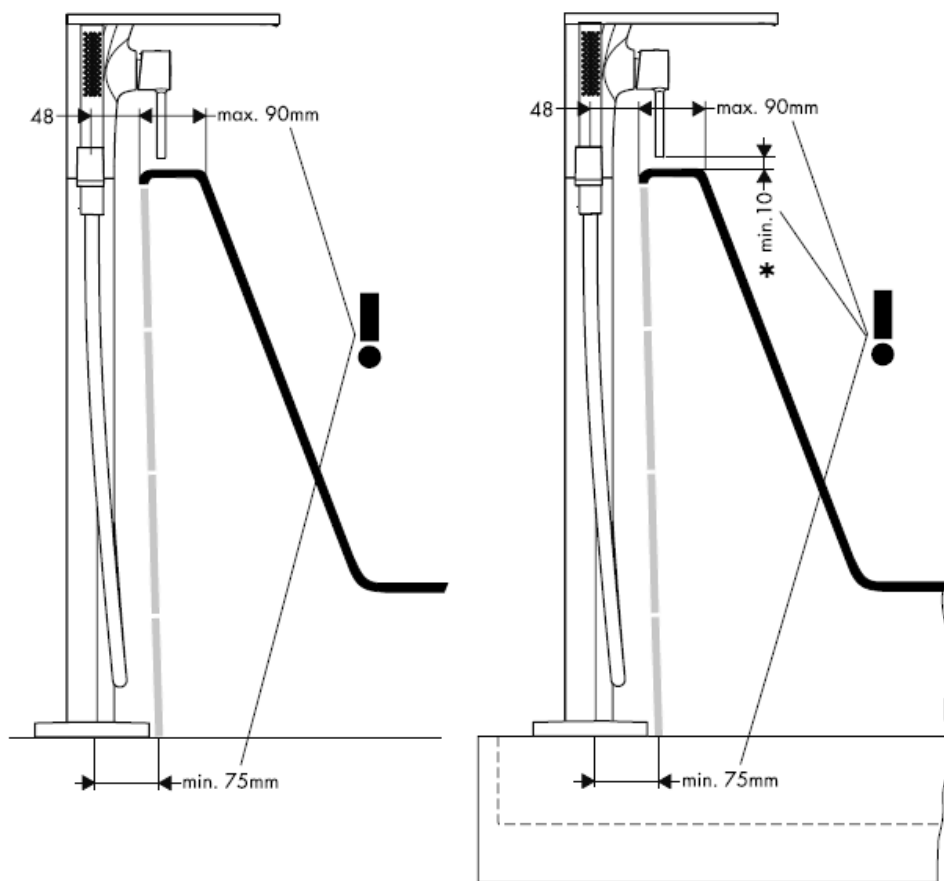

* < 10 min = Pidennys 60 mm (tuotenumero 97686000)

Citterio 39451000

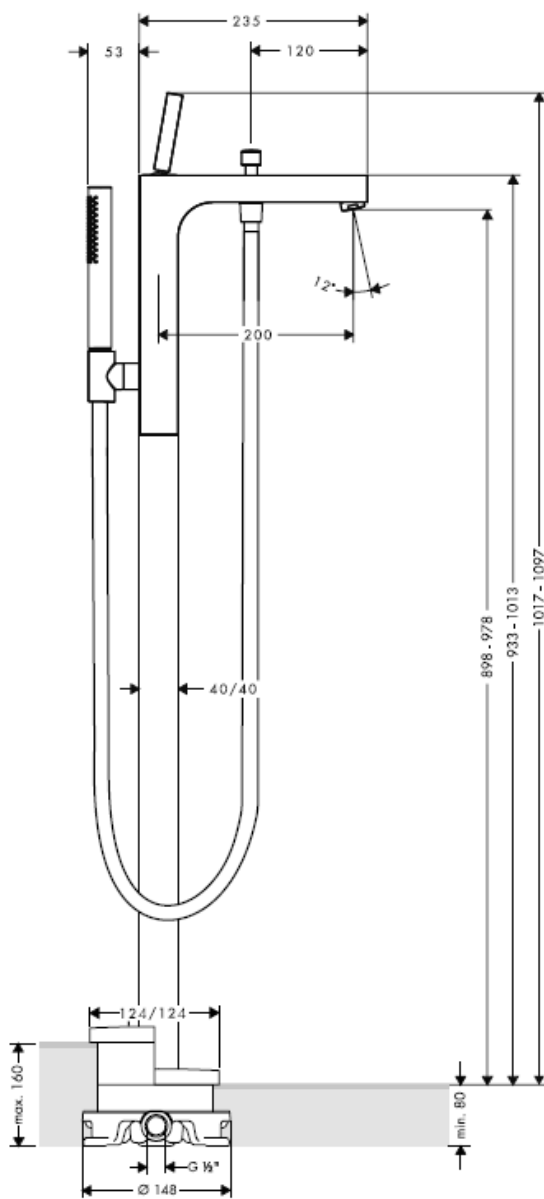

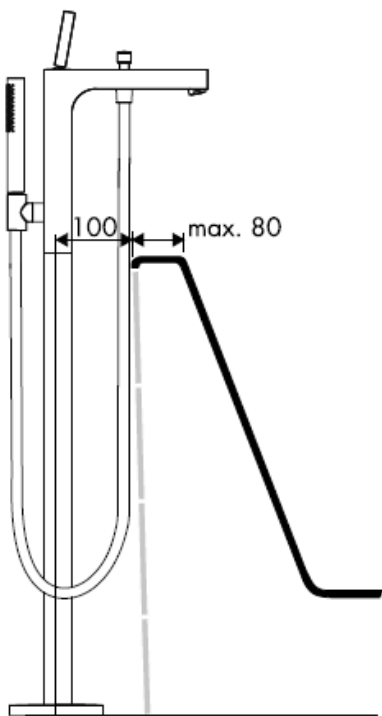

Huomio! Kaluste on asennettava, huuhdeltava ja tarkastettava voimassa olevien määräysten mukaisesti!

Starck 10452180

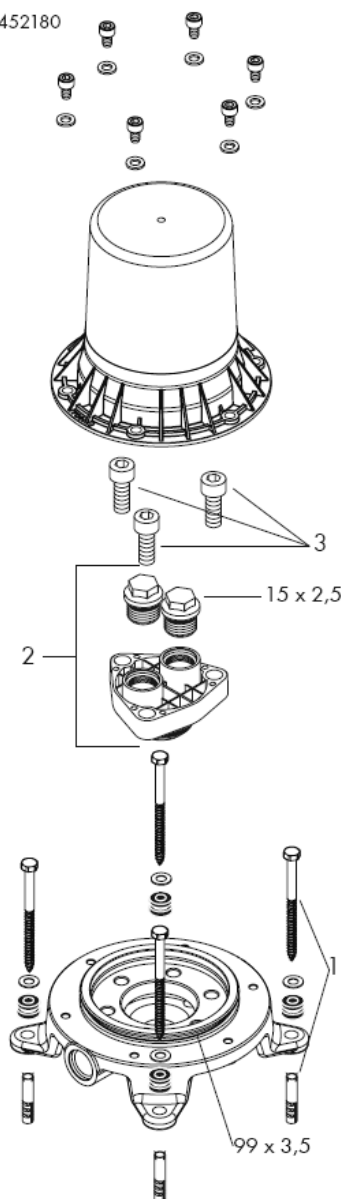

Montreux 16549180

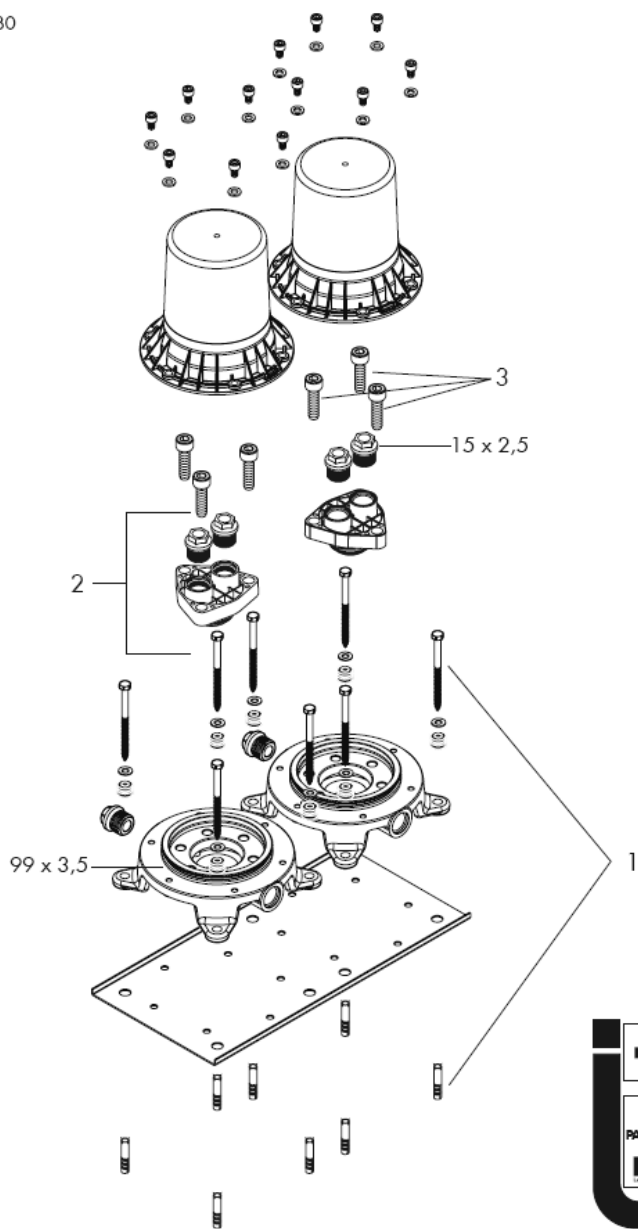

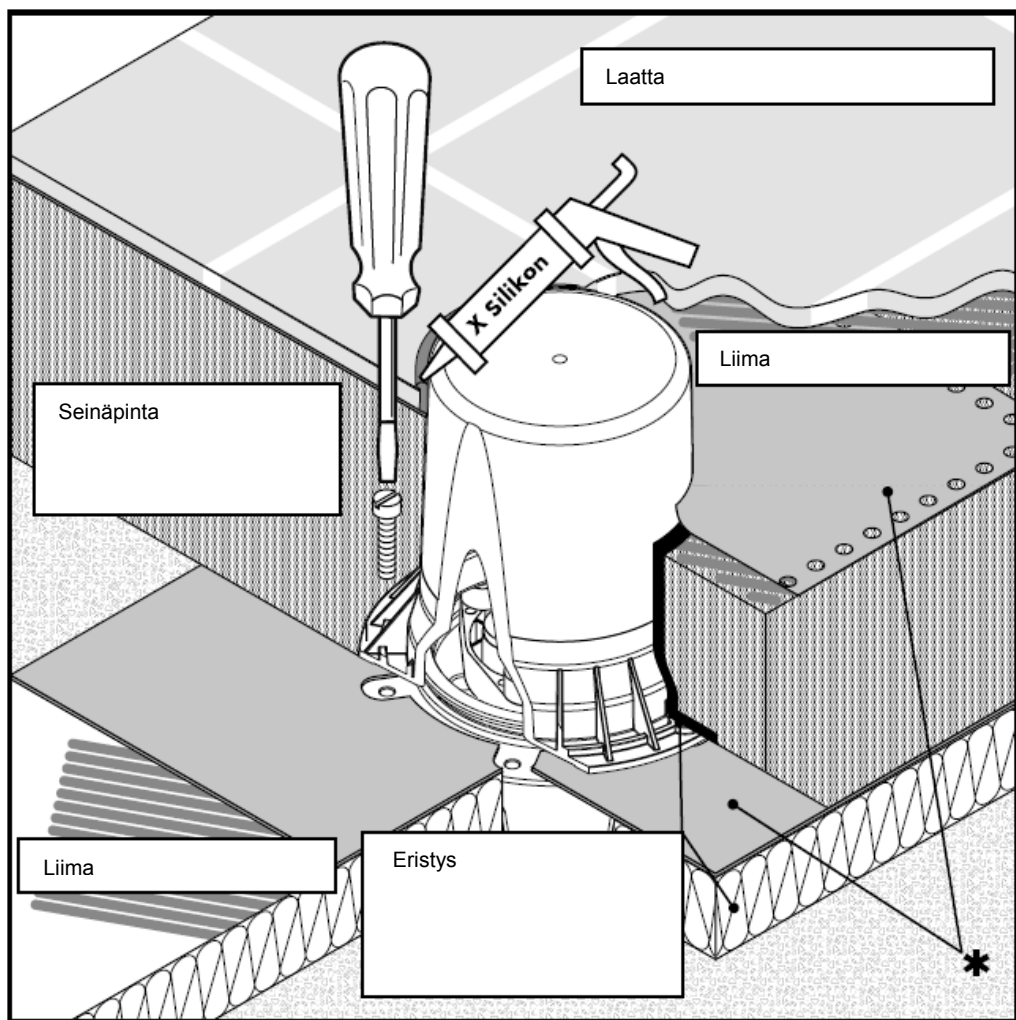

* Lisävarusteena saatava tiivisterengas

X Silikoni (etikkahappovapaa!)

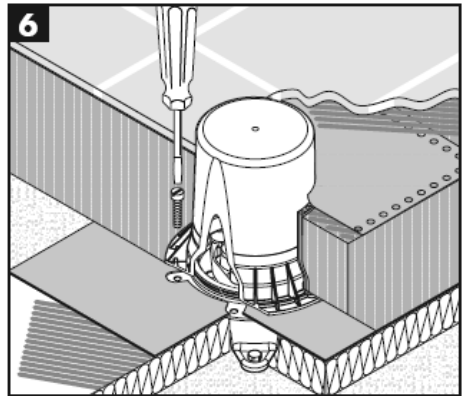
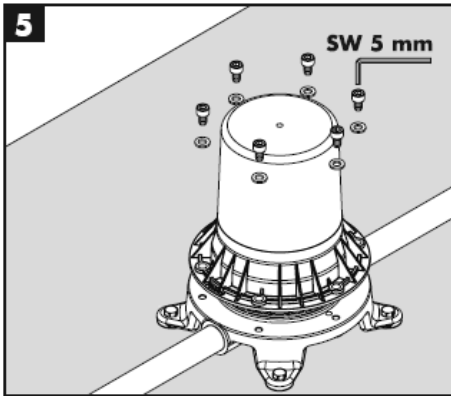
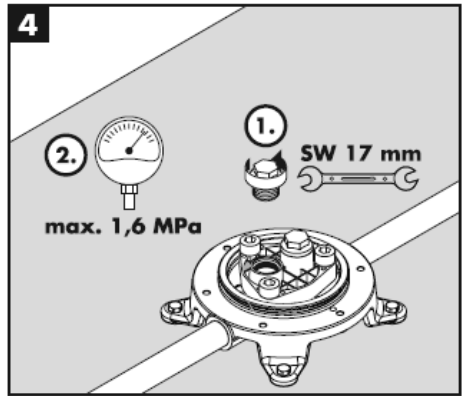
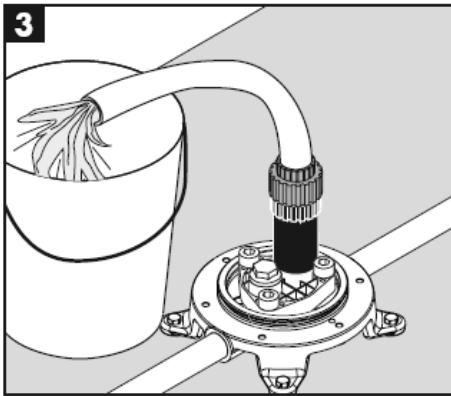
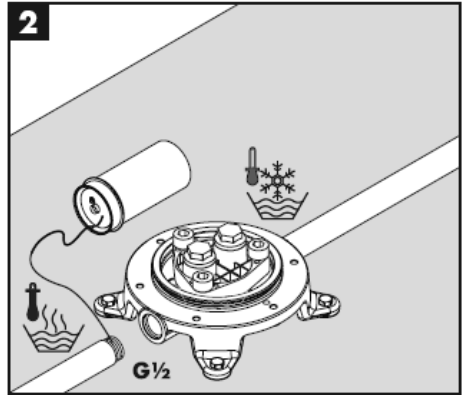
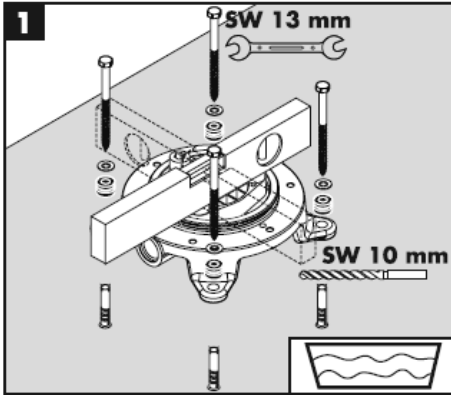

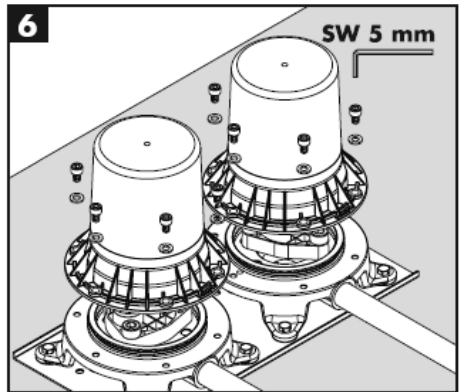
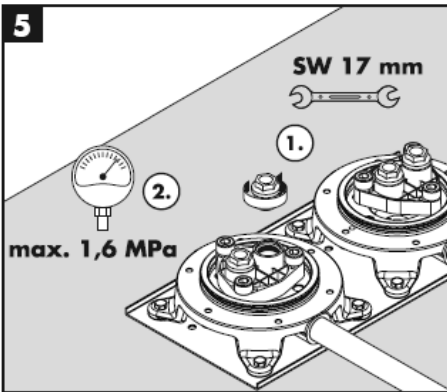
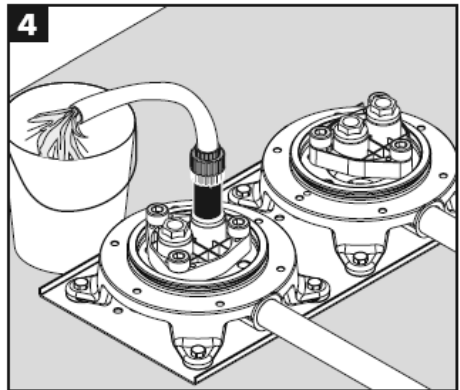
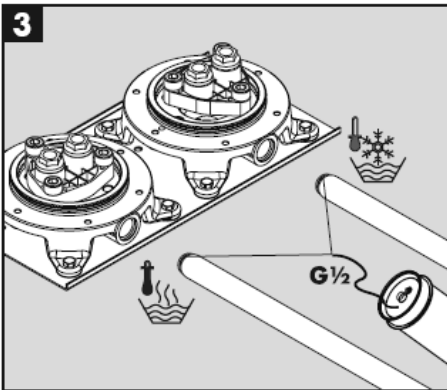
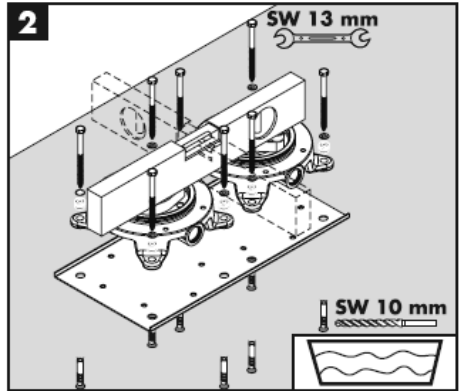
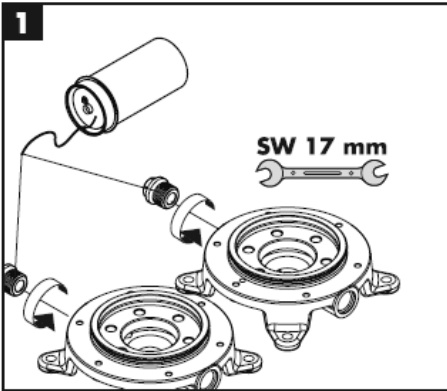

Asennus

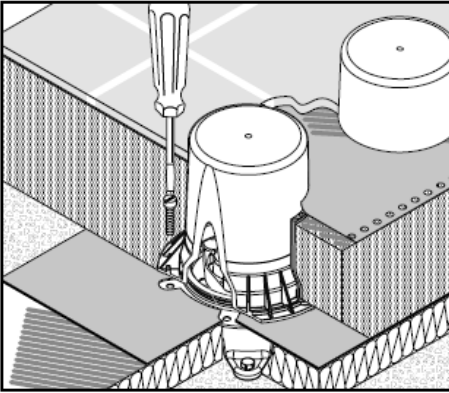

Suomi

Tekniset tiedot

Käyttöpaine:	max. 1 MPa
Suosittelu käyttöpain:	0,1 – 0,5 MPa
Koestuspaine:	1,6 MPa
(1 MPa = 10 bar = 147 PSI)	
Kuuman veden lämpötila:	max. 80° C
Kuuman veden suosituslämpötila:	65° C

Varaosat katso sivu 10 – 11

Kiinnityssarja	96260000
Tiivistesarja	96459000
Lieriökantaruuvi M 10 x 35	97670000

Erityisvaruste

* Tiivisterengas (ei kuulu toimitukseen)	96441000
---	----------

Koestusmerkki

	DVGW	P-IX	SVGW	ACS	NF	WRAS	KIWA
10452180				x		X	
16549180		PA-IX 18729/ICB					

hansgrohe

Monteringsanvisning

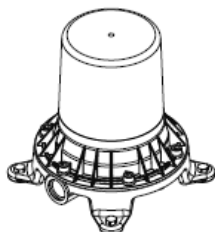

Starck
10452180

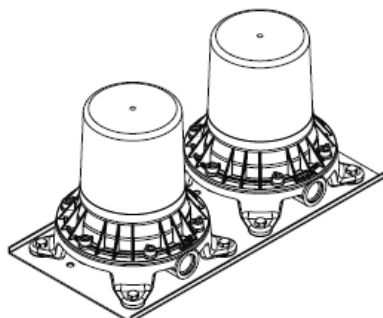

Montreux
16549180

AXOR[®]

hansgrohe

Starck 10458XXX

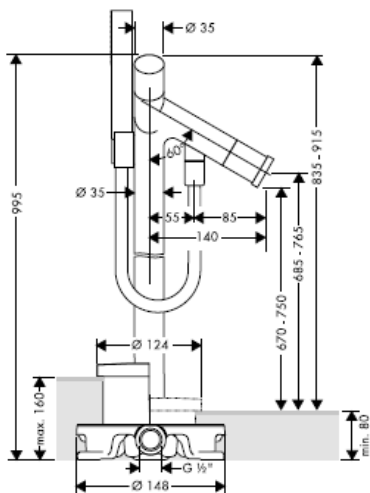

Starck 10060XXX

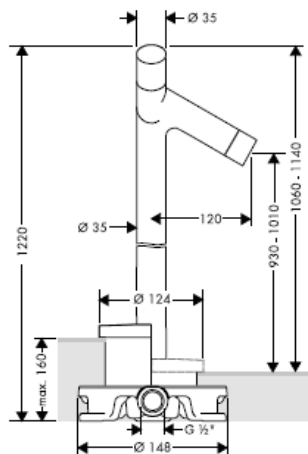

Starck 10456XXX

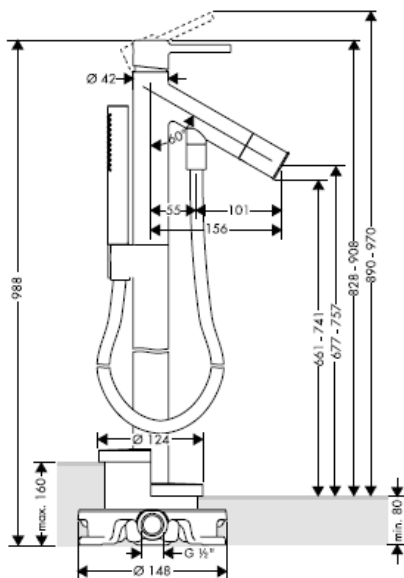

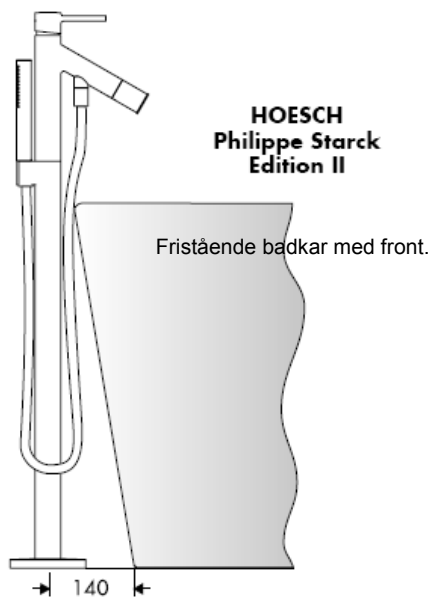
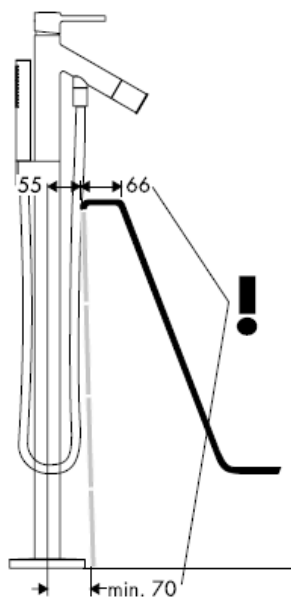
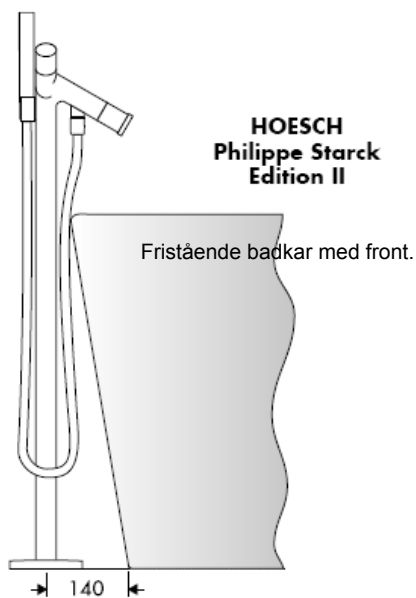

Starck X 10406000

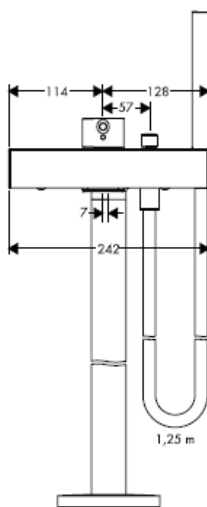
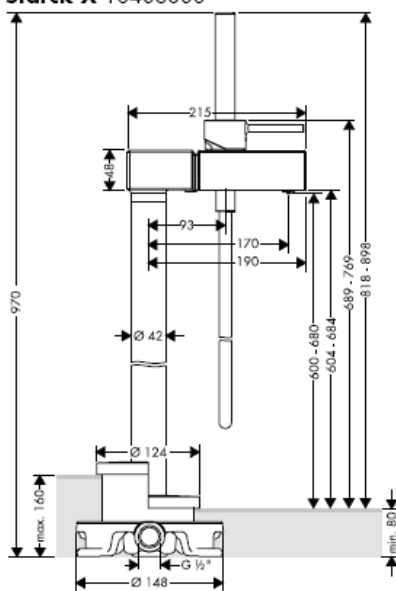

Montreux 16547XXX

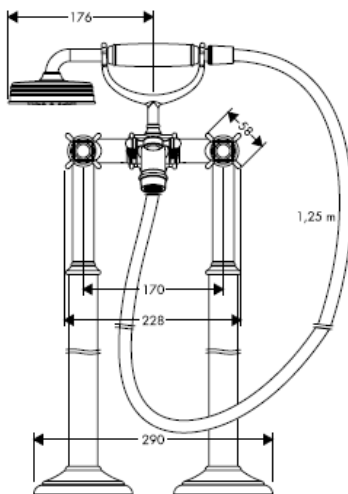
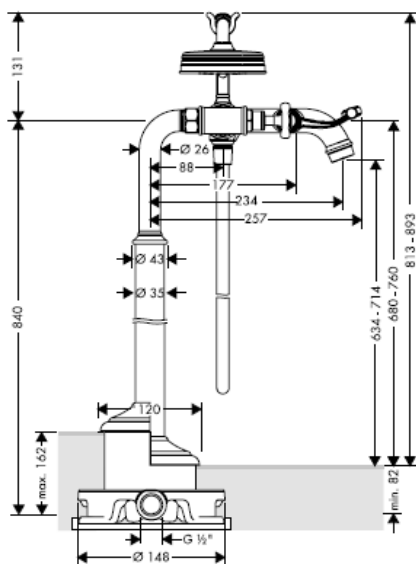

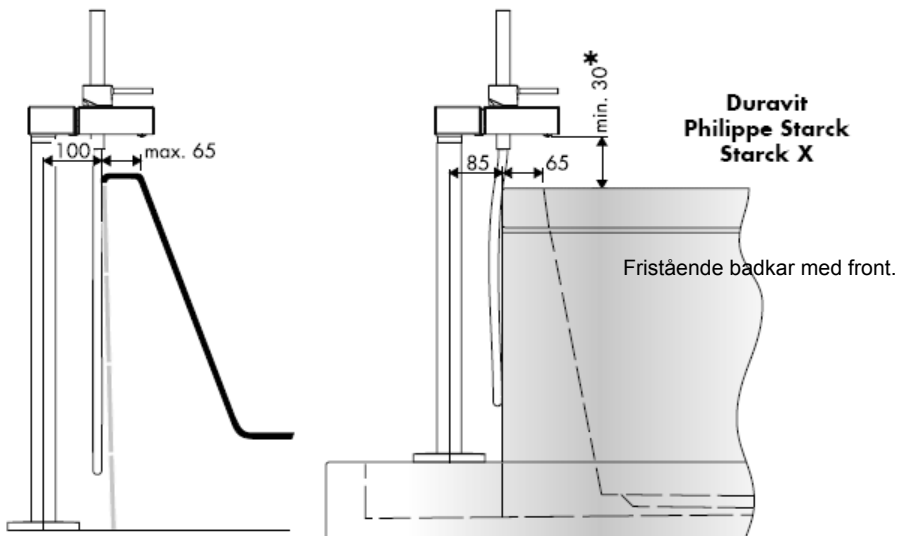

* < 30 min = Förlängning 60 mm (artikelnummer 97686000)



Massaud 18450000

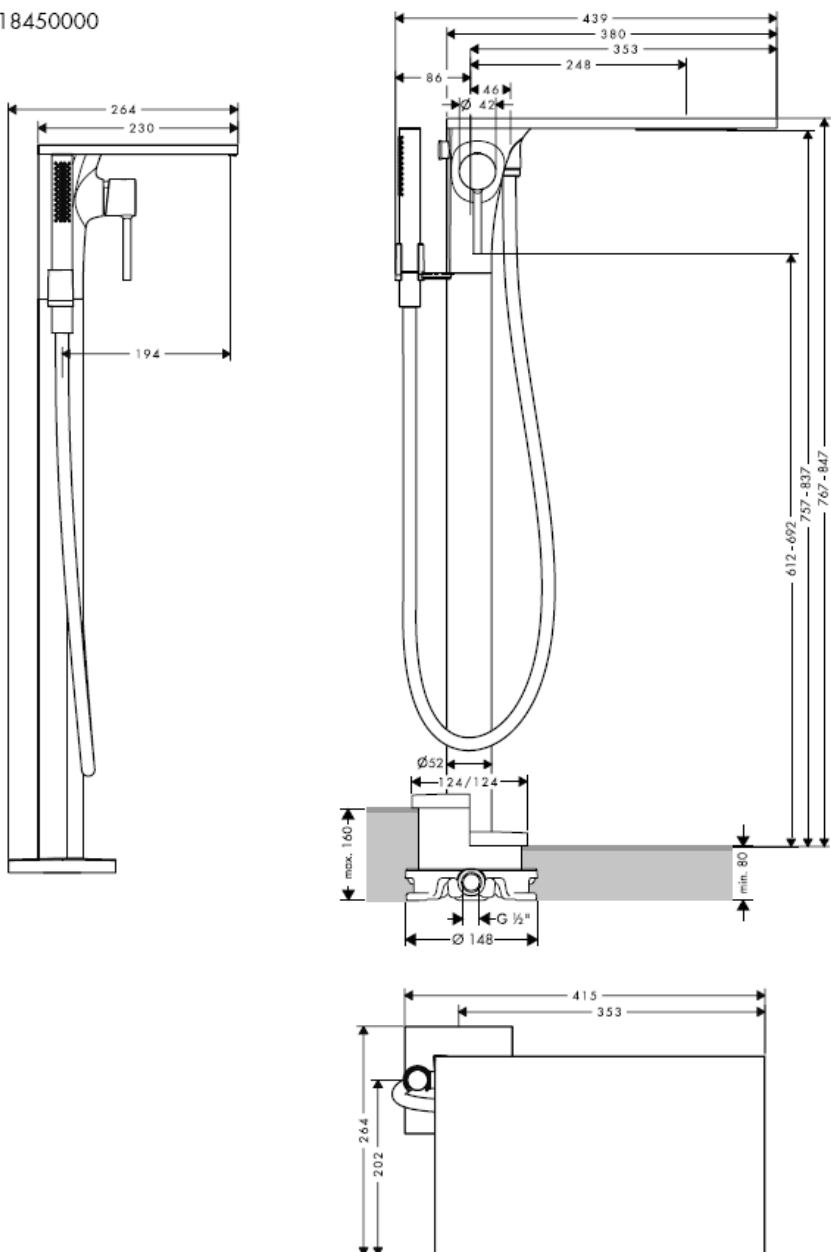

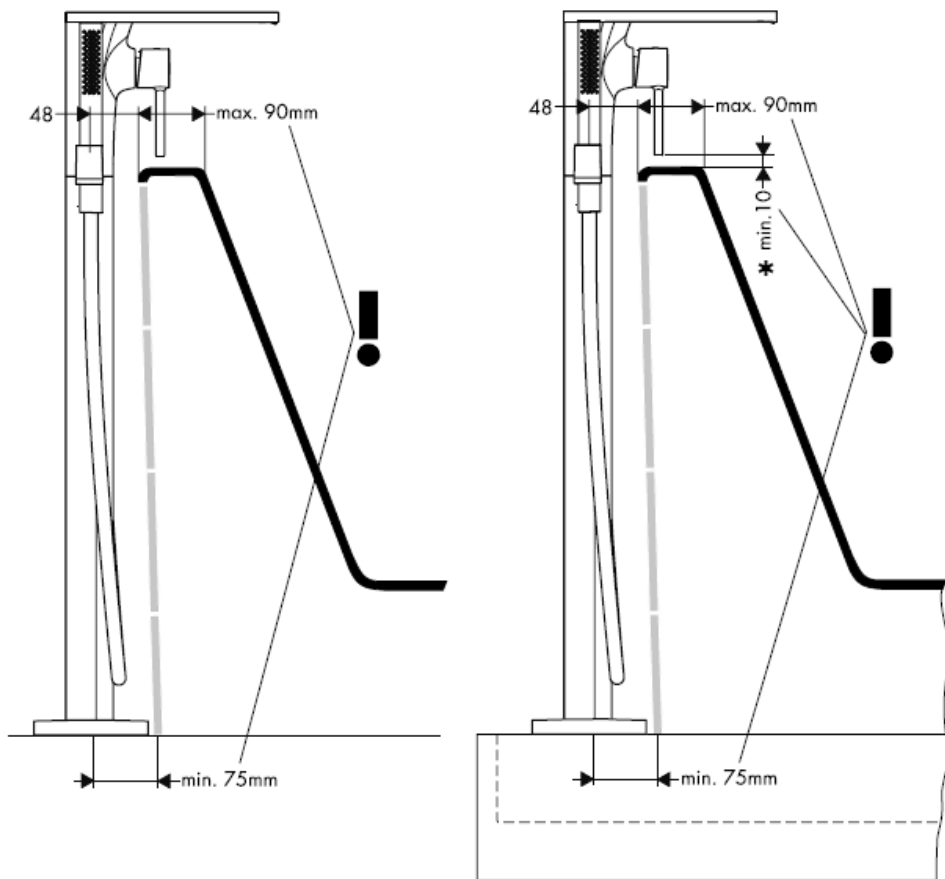

* < 10 min = Förlängning 60 mm (artikelnummer 97686000)

Citterio 39451000

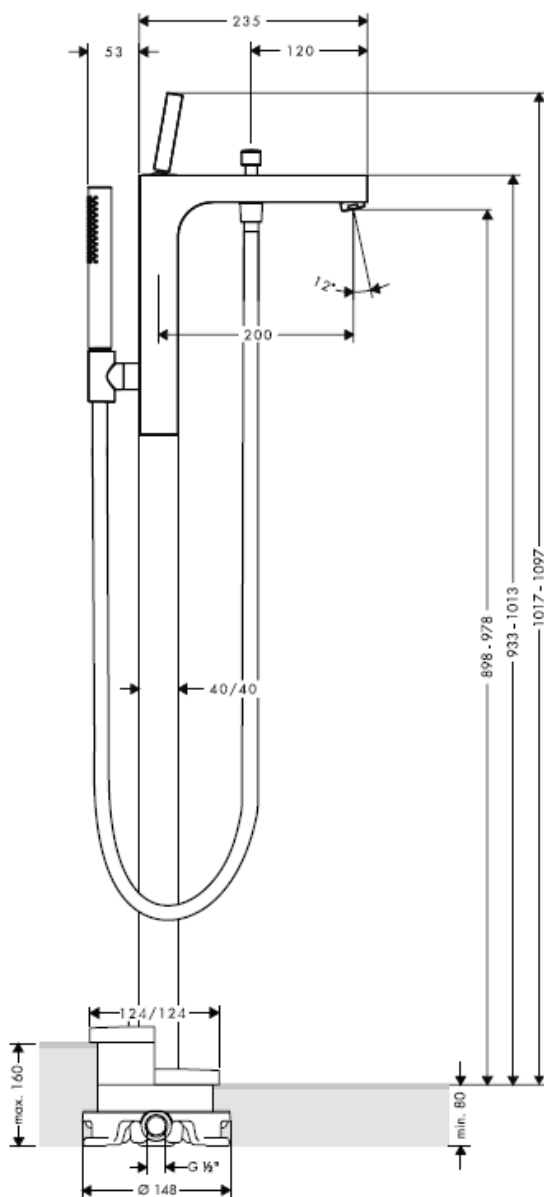

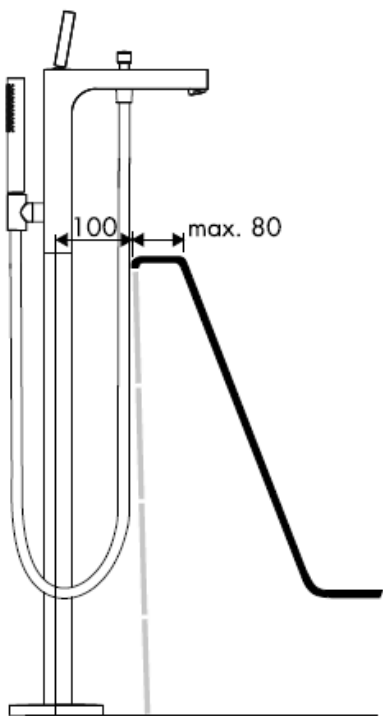

OBS! Blandaren måste installeras, genomspolas och testas enligt gällande föreskrifter.

Starck 10452180

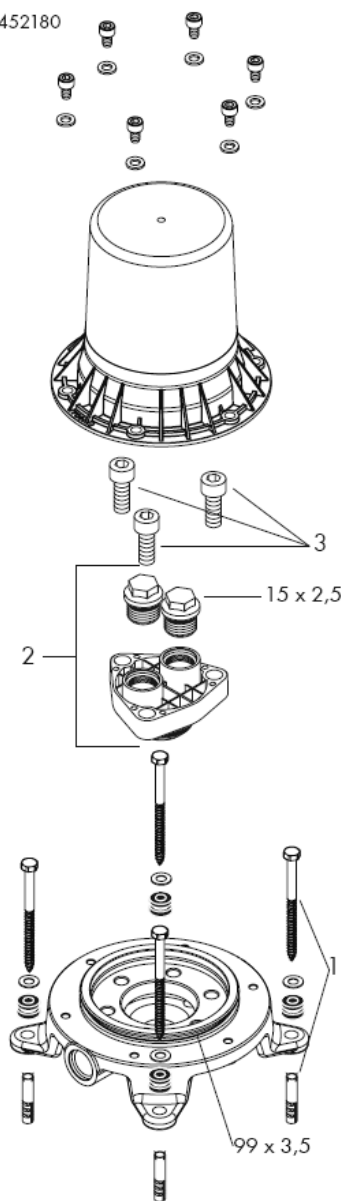

Montreux 16549180

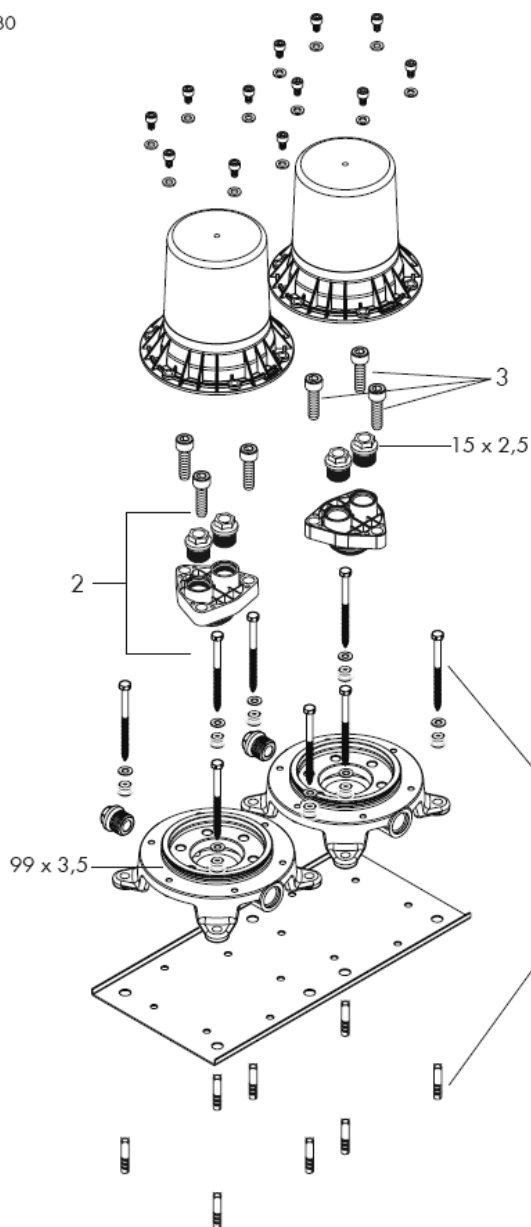

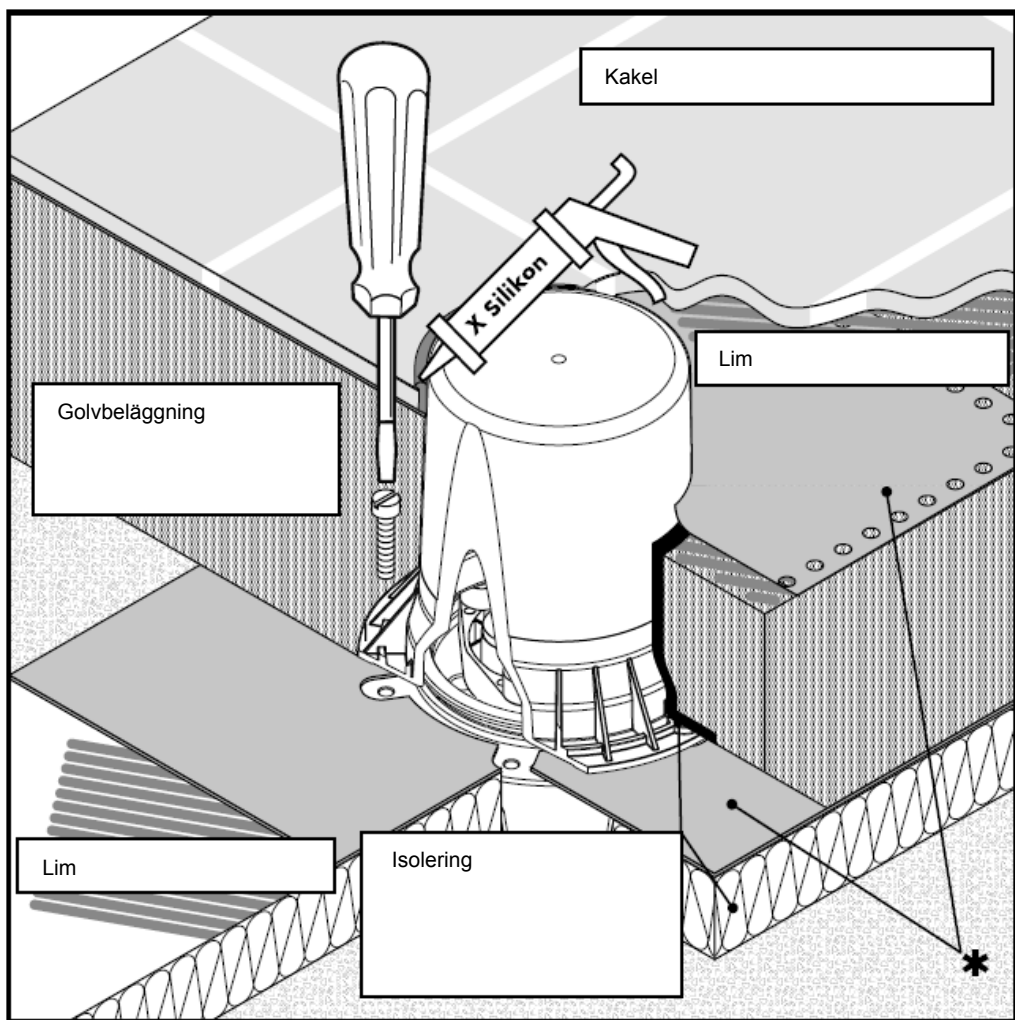

* tätningmanschett finns som tillval

X Silikon (fri från ättiksyra!)

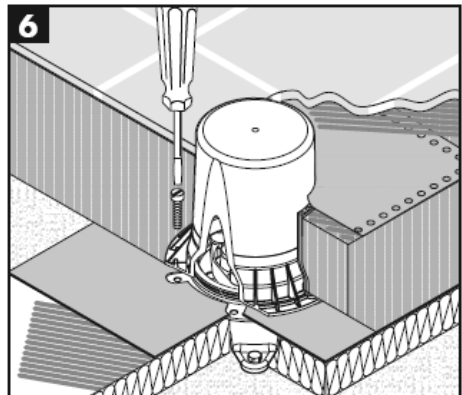
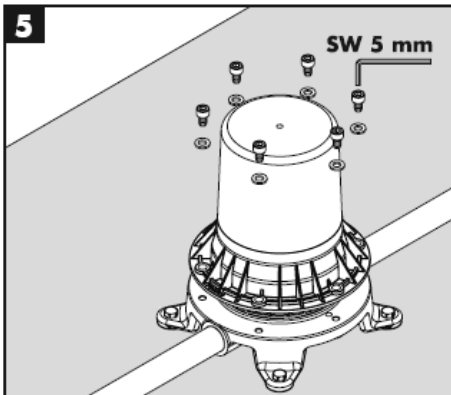
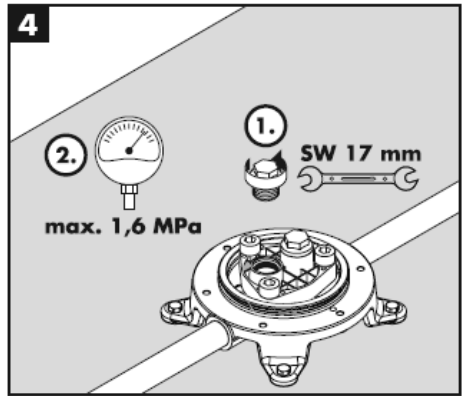
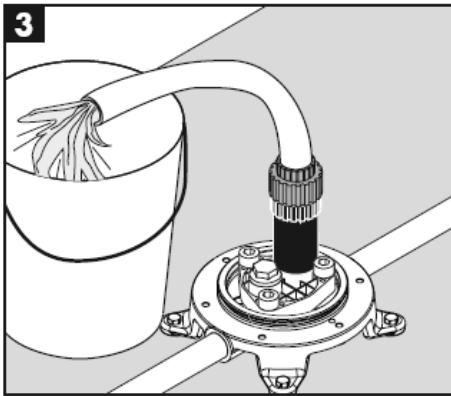
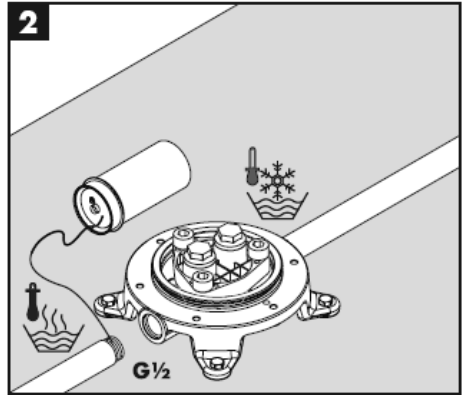
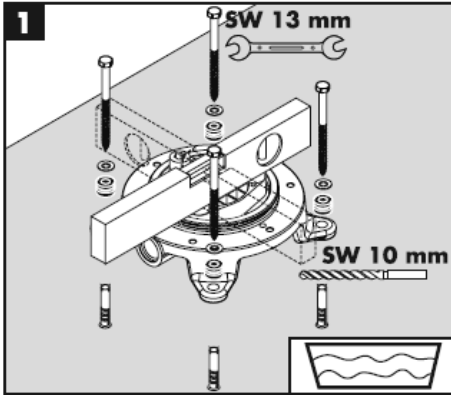

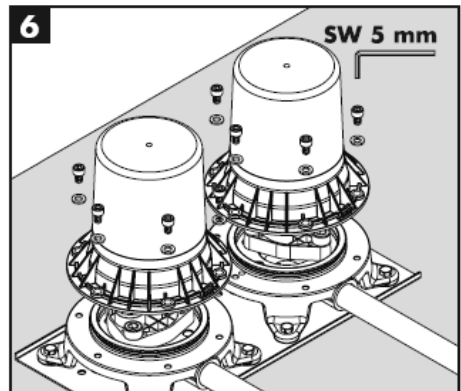
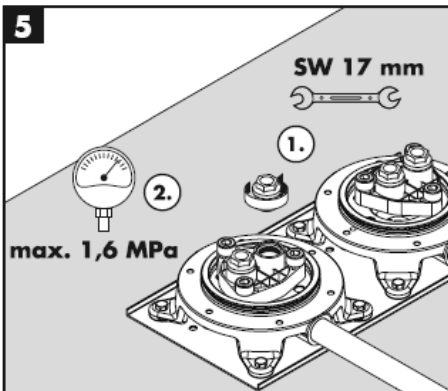
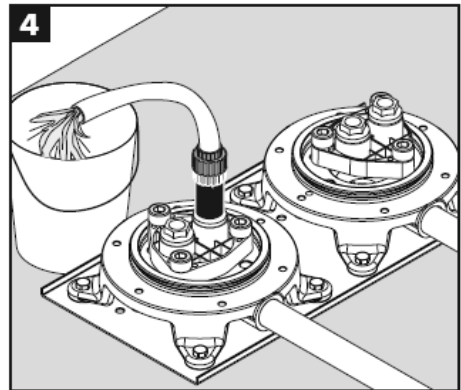
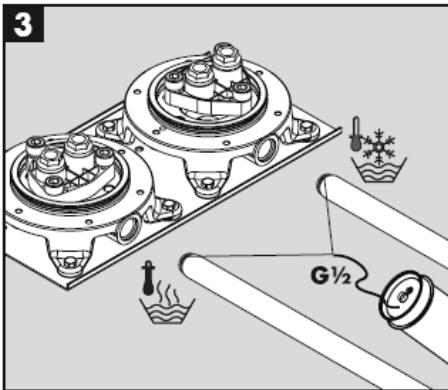
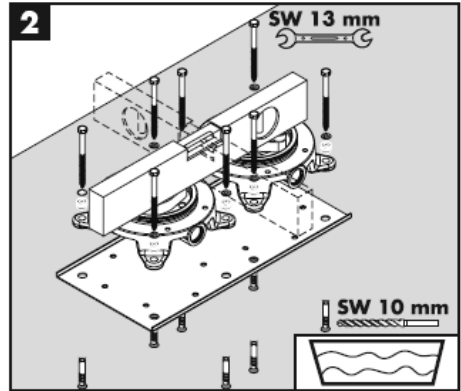
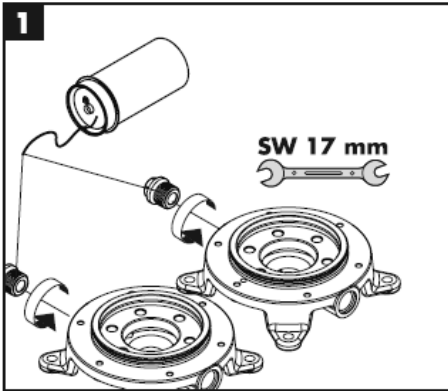

Montering

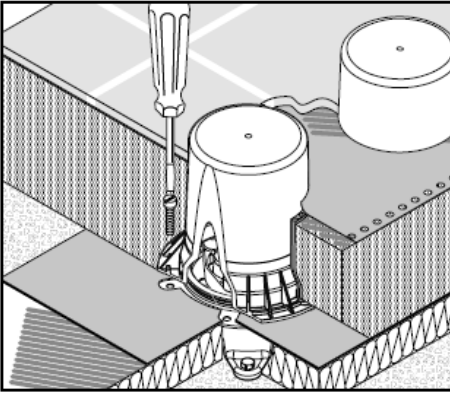

Svenska

Tekniska data

Driftstryck:	max. 1 MPa
Rek. driftstryck:	0,1 – 0,5 MPa
Tryck vid provtryckning: (1 MPa = 10 bar = 147 PSI)	1,6 MPa
Varmvattentemperatur:	max. 80° C
Rek. varmvattentemp.:	65° C

Reservdelar se sidan 10 – 11

Monteringsatts	96260000
Packningsset	96459000
Cylinderskruv M 10 x 35	97670000

Specialtillbehör

* Tätningmanschett (medföljer ej leveransen)	96441000
---	----------

Testsigill

	DVGW	P-IX	SVGW	ACS	NF	WRAS	KIWA
10452180				x		X	
16549180		PA-IX 18729/ICB					

hansgrohe

Montavimo instrukcijos

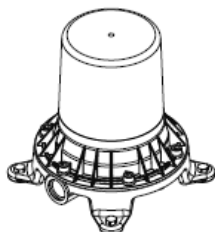

Starck
10452180

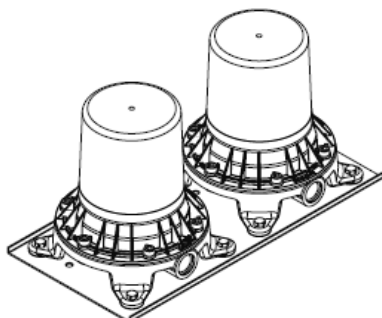

Montreux
16549180

AXOR[®]

hansgrohe

Starck 10458XXX

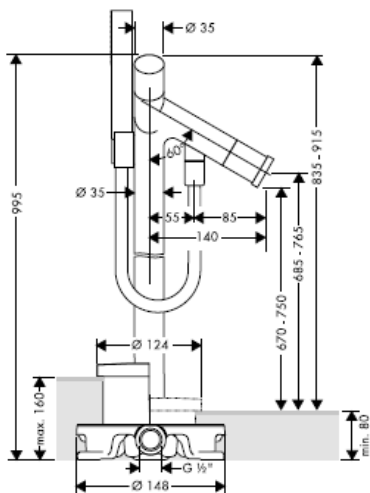

Starck 10060XXX

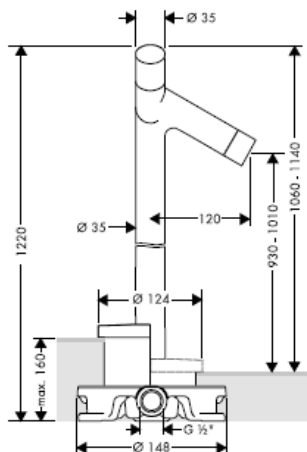

Starck 10456XXX

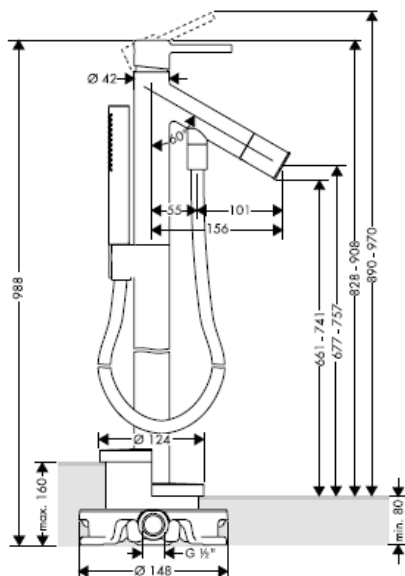

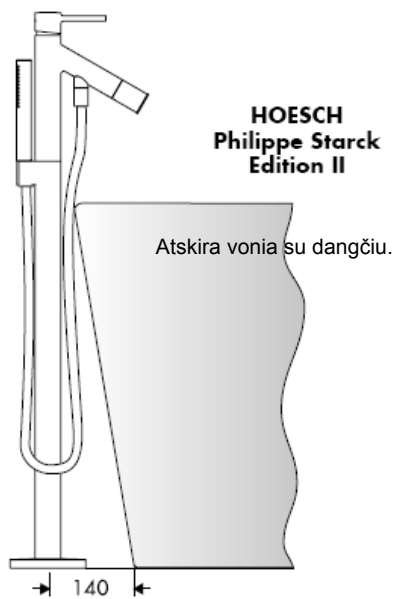
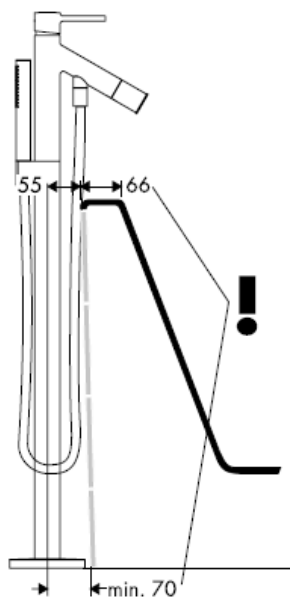

Starck X 10406000

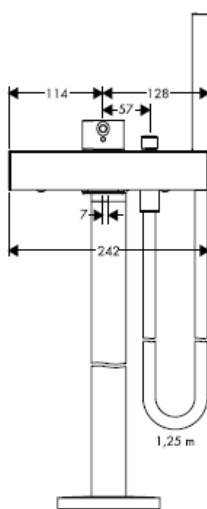
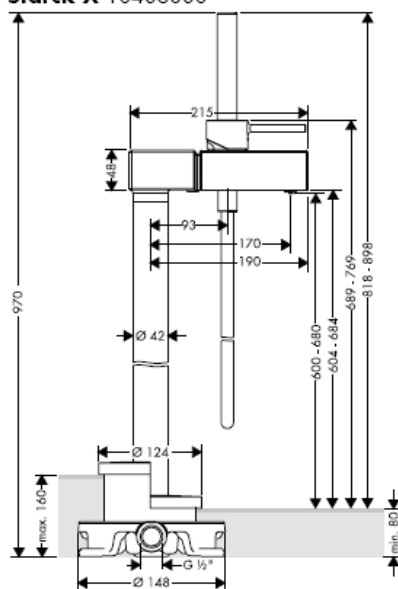

Montreux 16547XXX

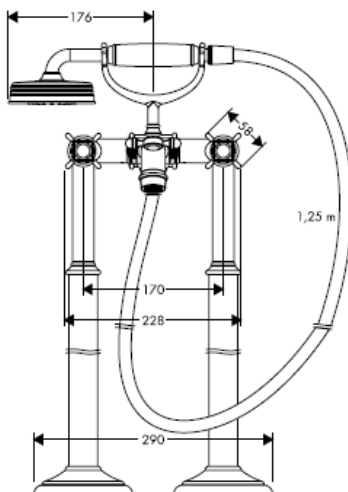
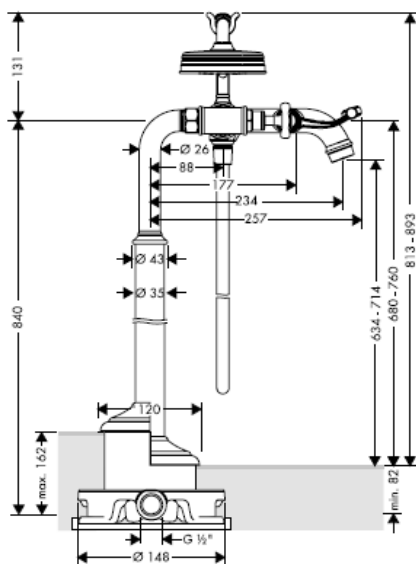

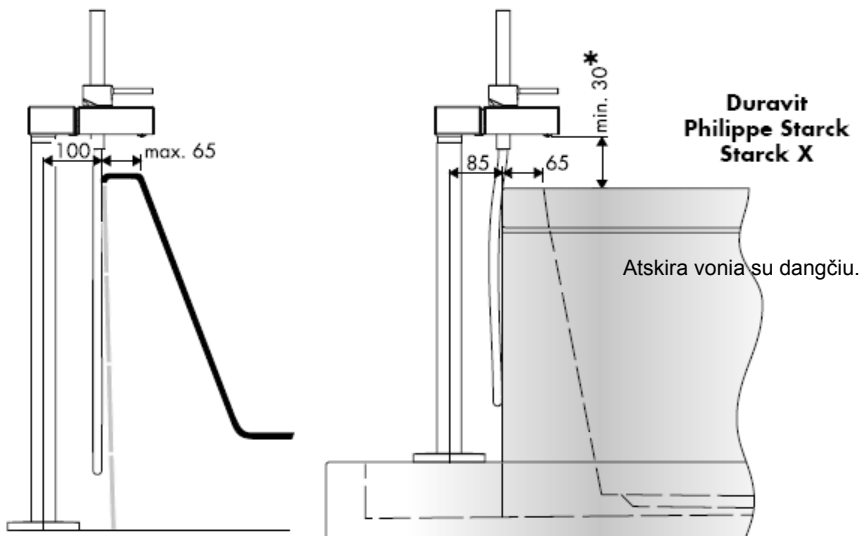

* < 30 min = Ilgiklis 60 mm (Art.Nr. 97686000)



Massaud 18450000

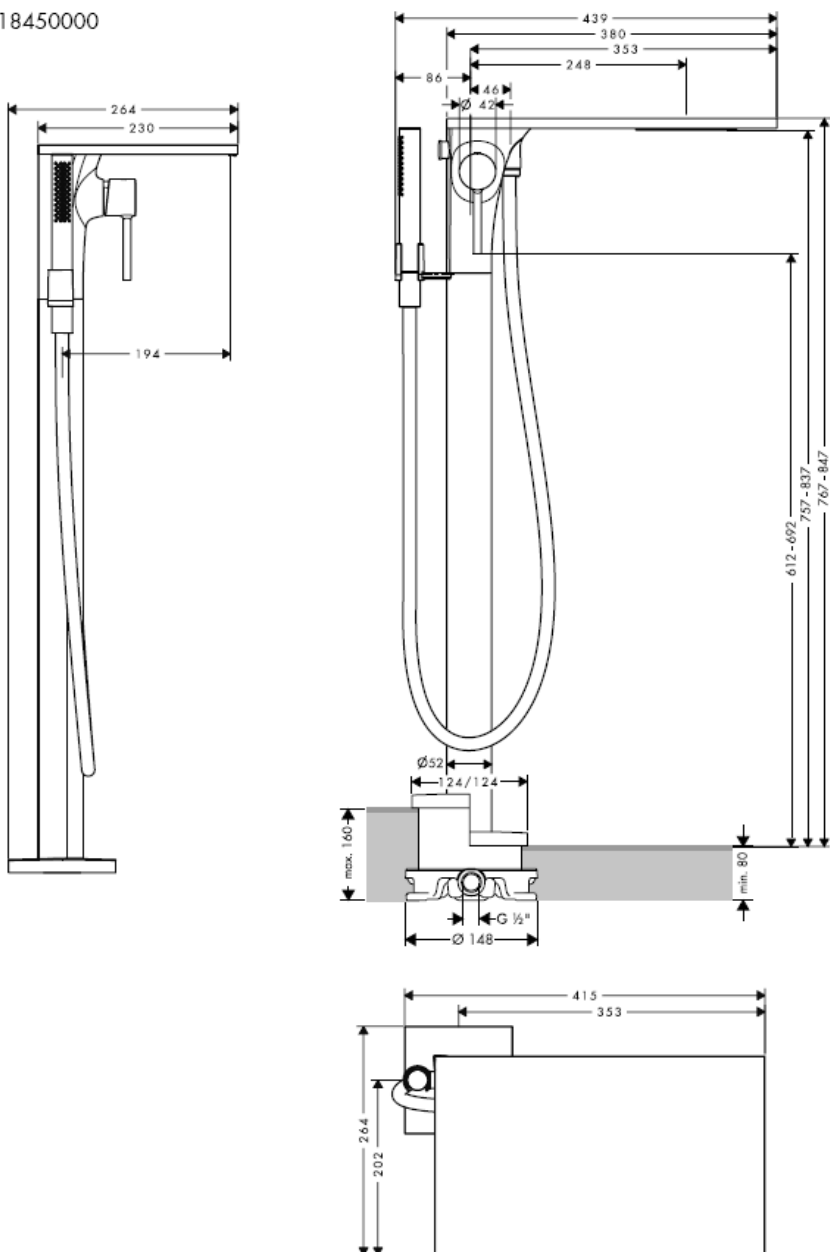

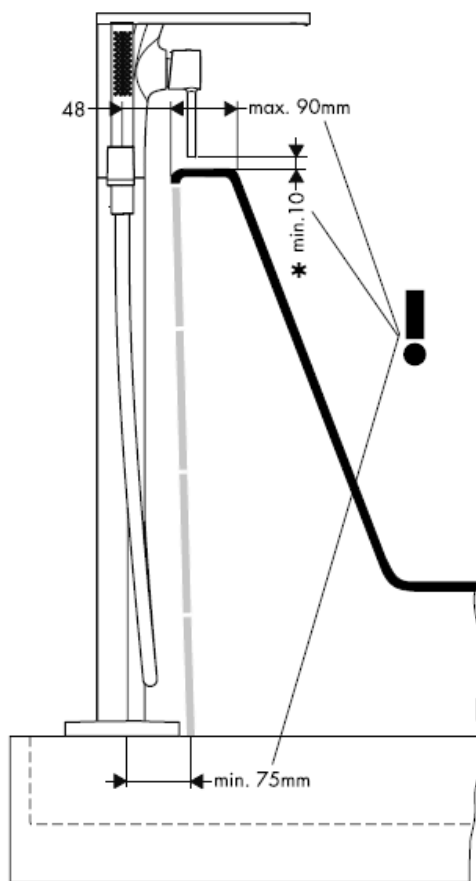
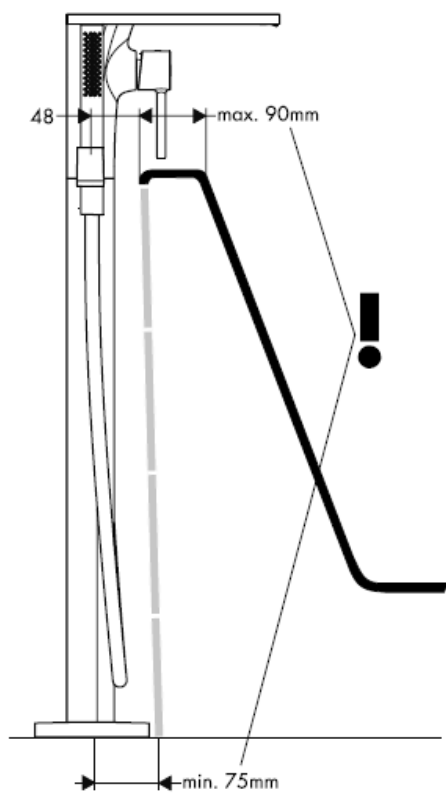

* < 10 min = Ilgiklis 60 mm (Art.Nr. 97686000)

Citterio 39451000

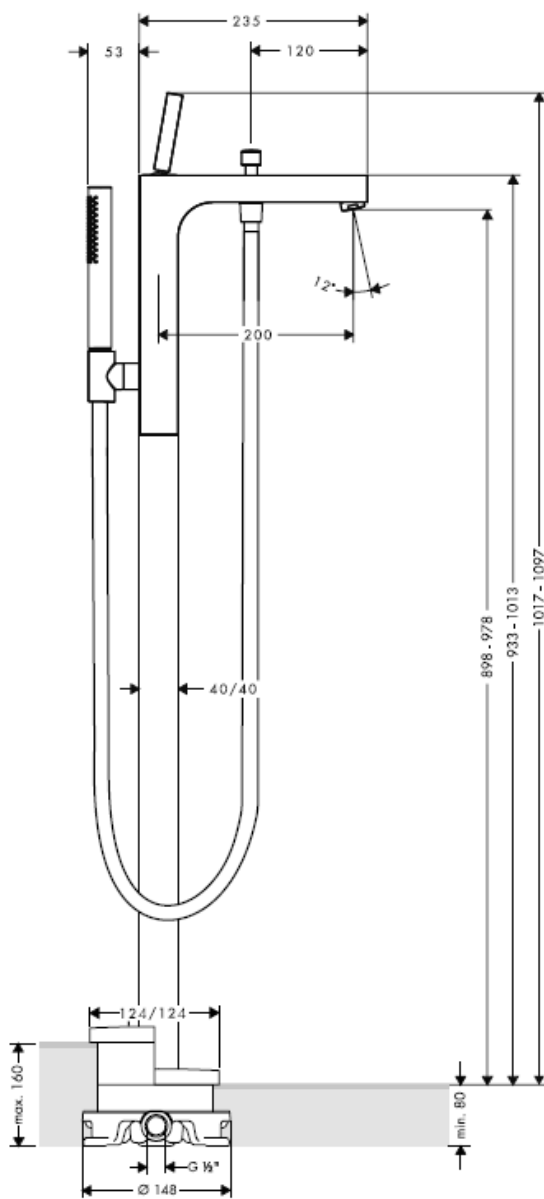

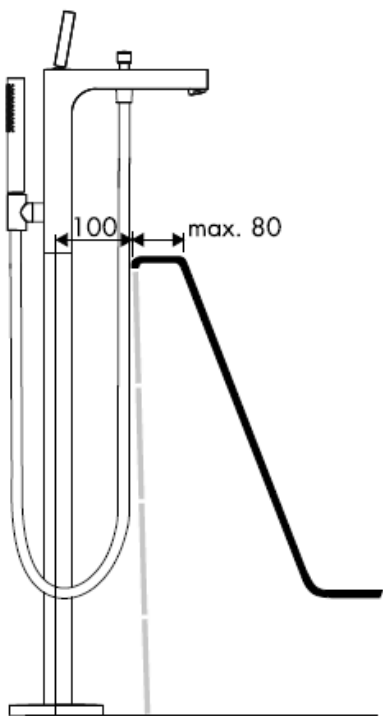

Dėmesio! Maišytuvas privalo būti montuojamas, išleidžiamas ir patikrinamas pagal galiojančias normas!

Starck 10452180

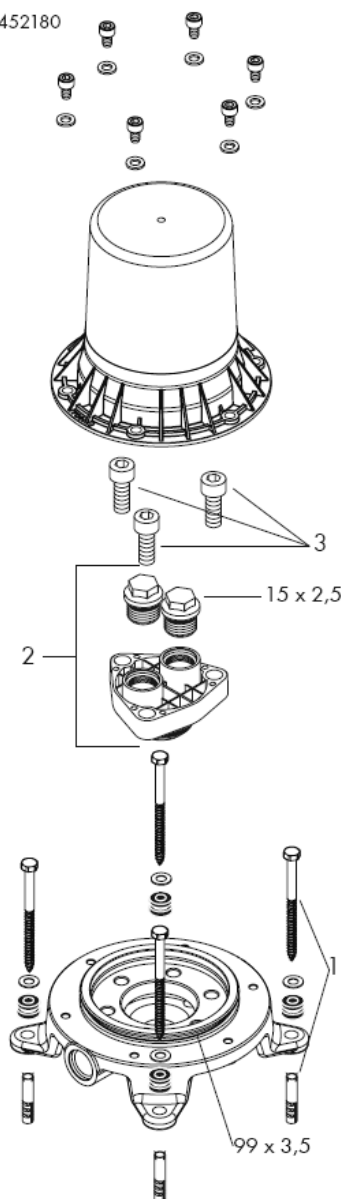

Montreux 16549180

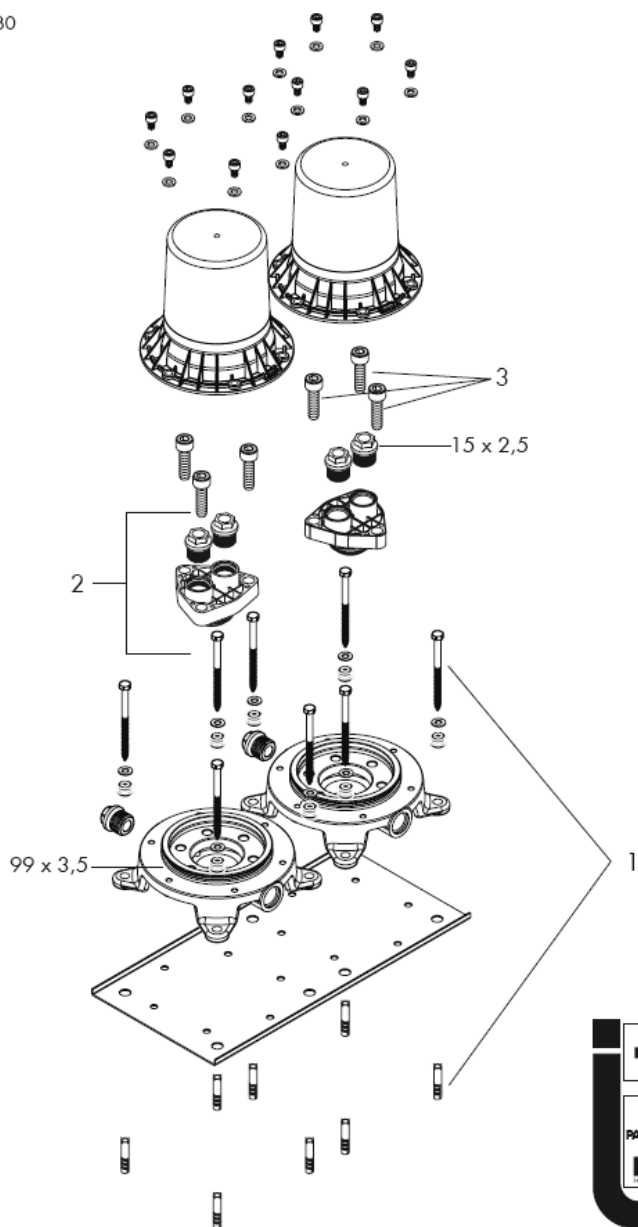

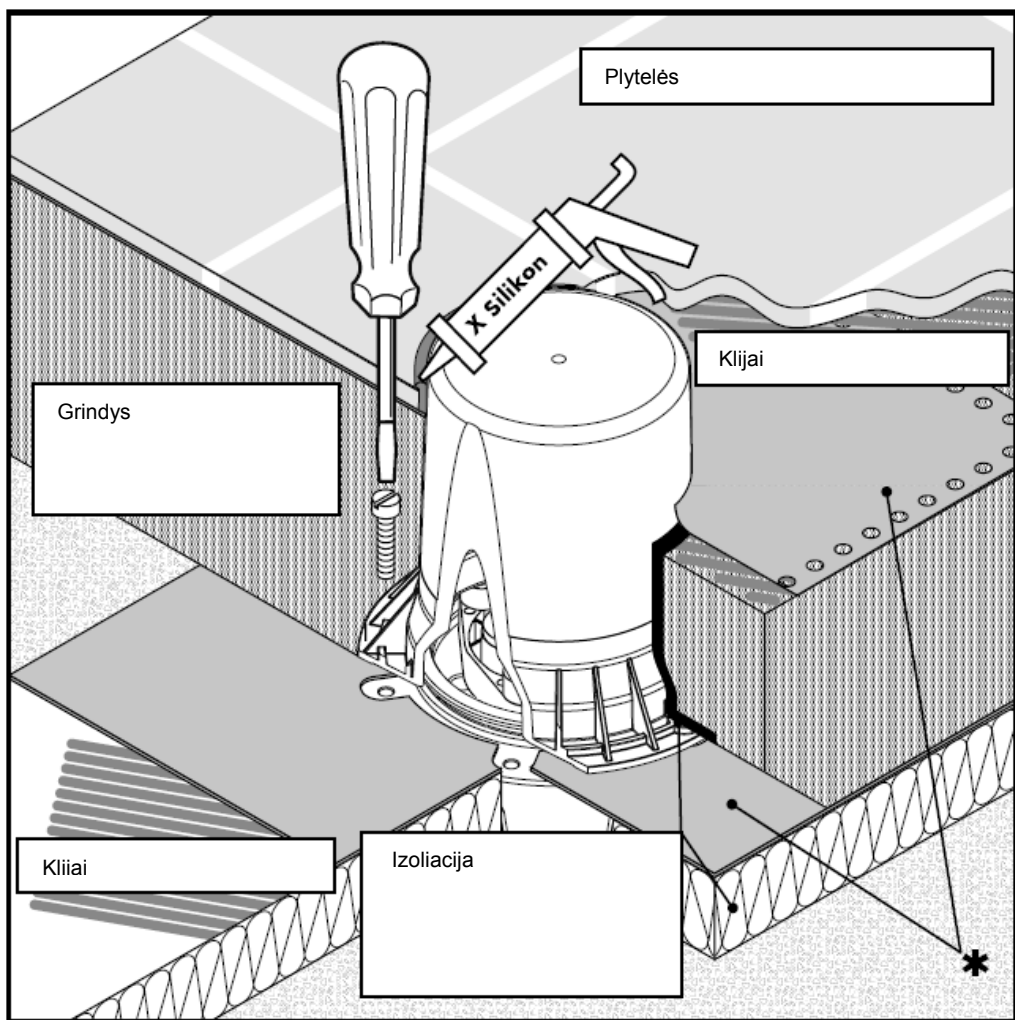

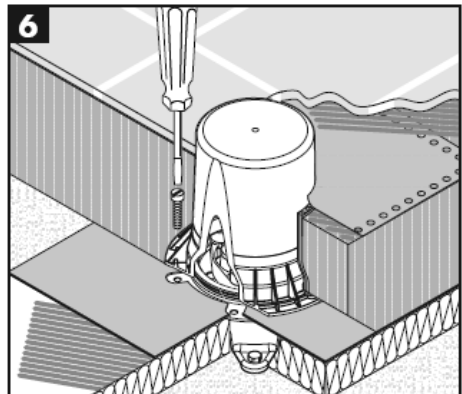
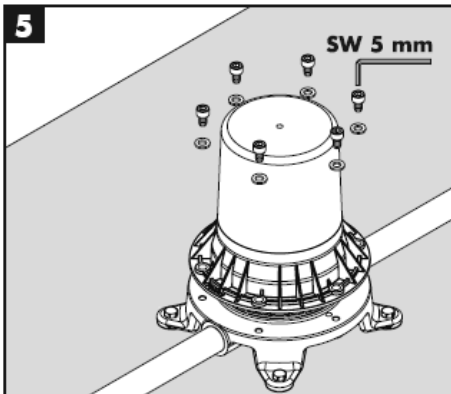
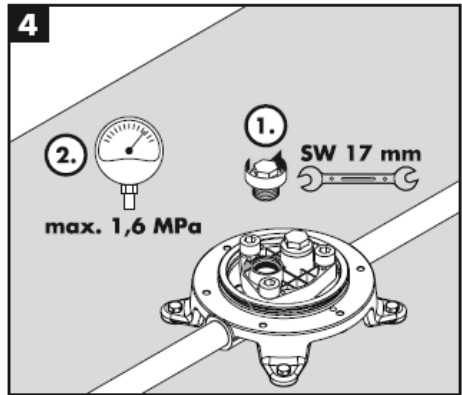
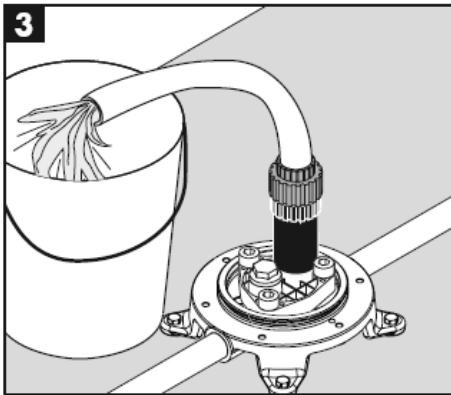
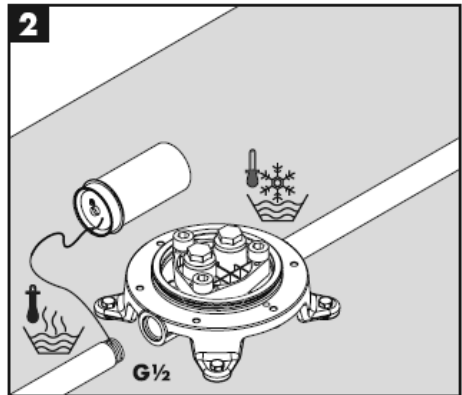
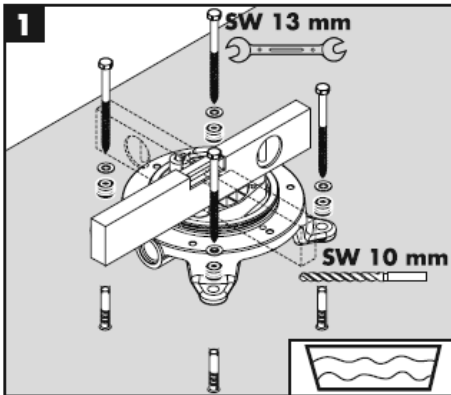

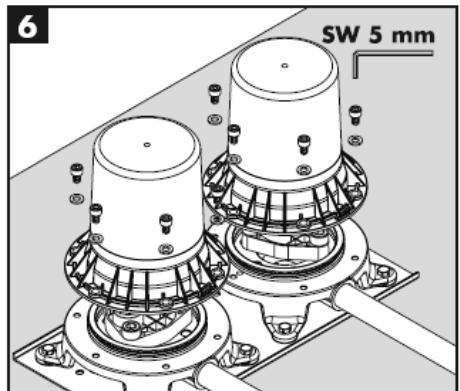
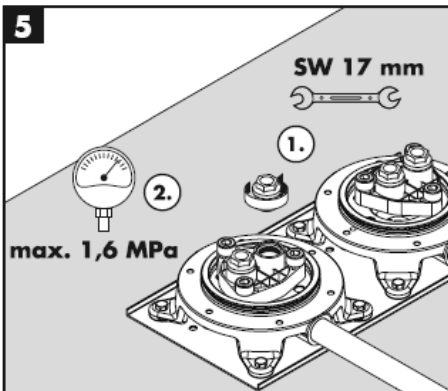
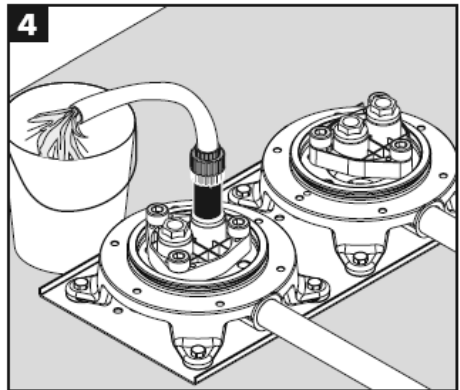
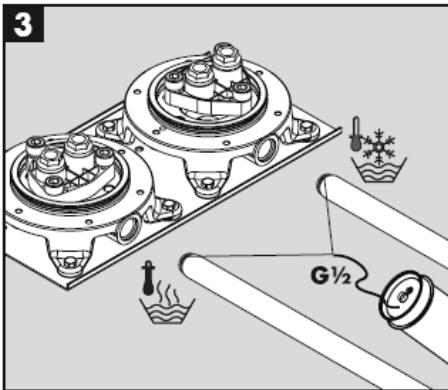
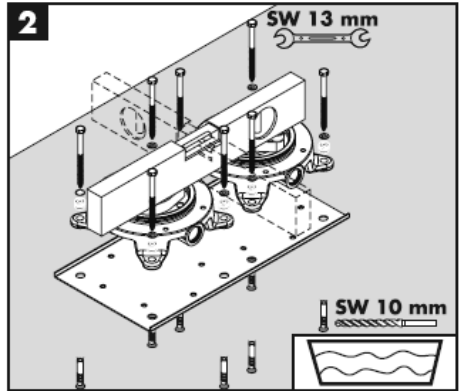
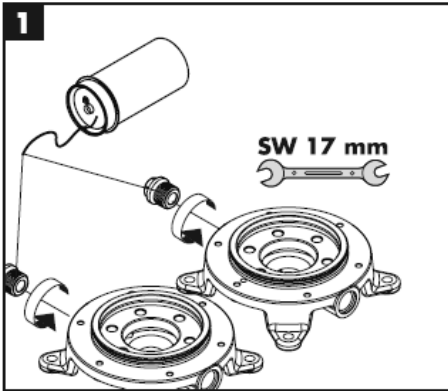

Montavimas

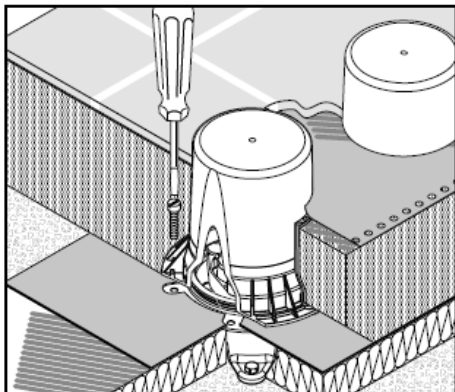

Lietuviškai

Techniniai duomenys

Darbinis slėgis:	max. 1 MPa
Rekomenduojamas slėgis:	0,1 – 0,5 MPa
Bandomasis slėgis: (1 MPa = 10 barų = 147 PSI)	1,6 MPa
Karšto vandens temperatūra:	max. 80° C
Rekomenduojama karšto vandens temperatūra:	65° C

Bandymo pažyma

	DVGW	P-IX	SVGW	ACS	NF	WRAS	KIWA
10452180				x		X	
16549180		PA-IX 18729/ICB					

Atsarginės dalys žr. psl. 10 – 11

Prijungimo komplektas	96260000
Tarpinių rinkinys	96459000
Cilindrinis varžtas M 10 x 35	97670000

Specialūs priedai

* Sandarikliai (nėra pridodama)	96441000
------------------------------------	----------

hansgrohe

Uputstva za instalaciju

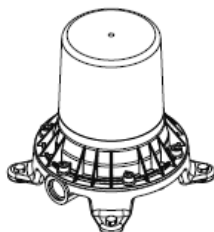

Starck
10452180

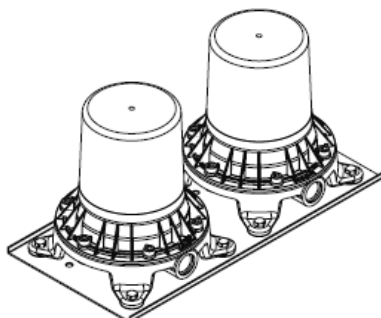

Montreux
16549180

AXOR[®]

hansgrohe

Starck 10458XXX

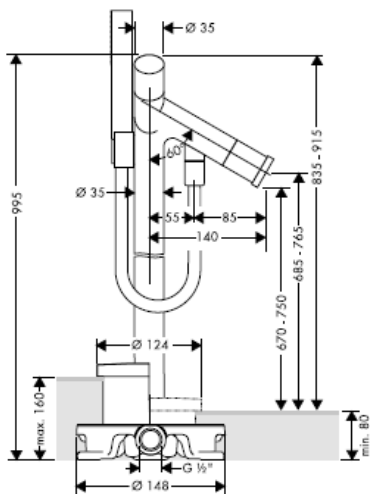

Starck 10060XXX

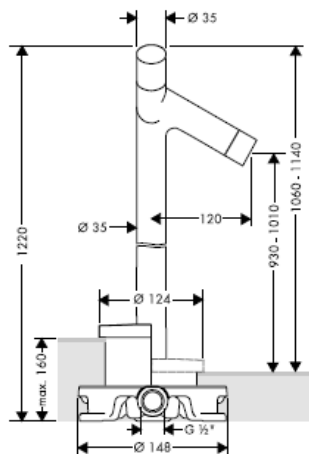

Starck 10456XXX

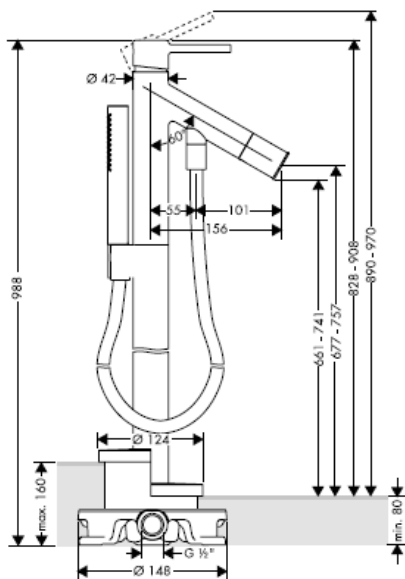

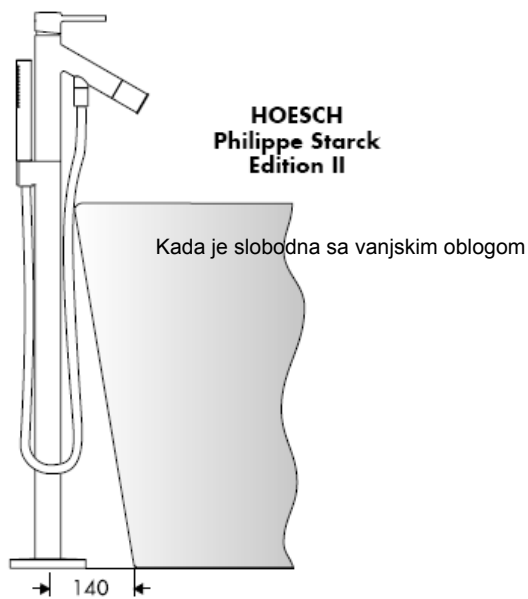
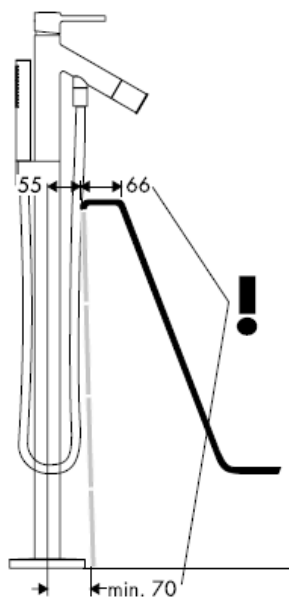
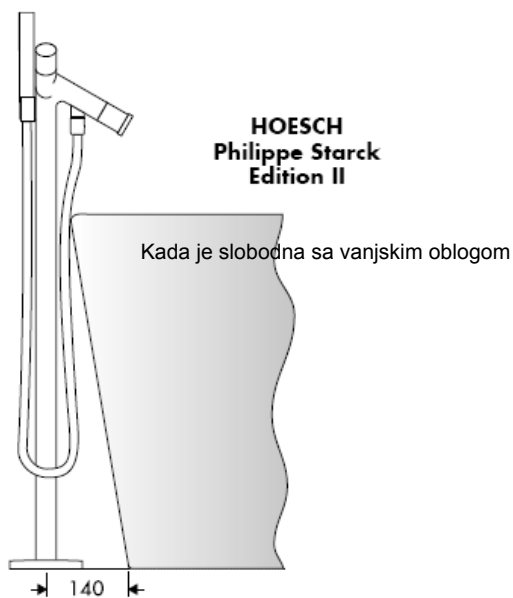
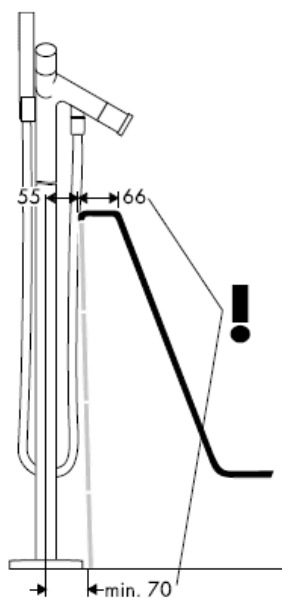

Starck X 10406000

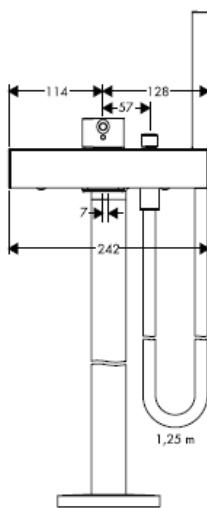
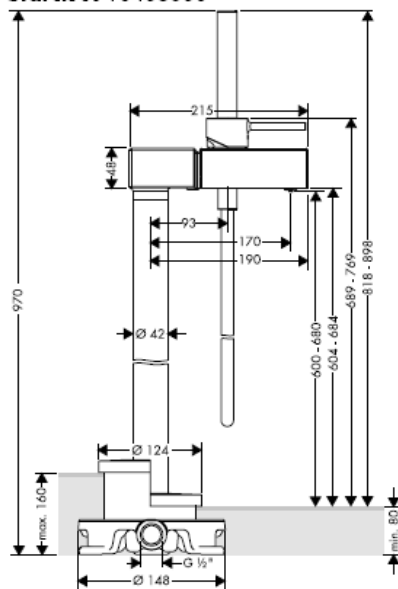

Montreux 16547XXX

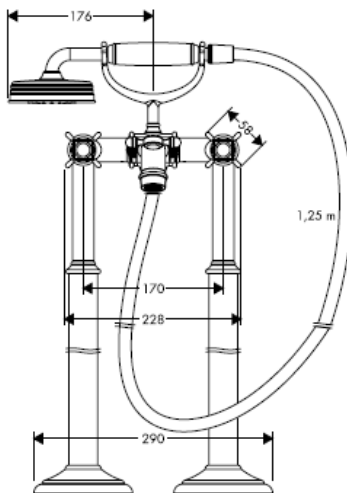
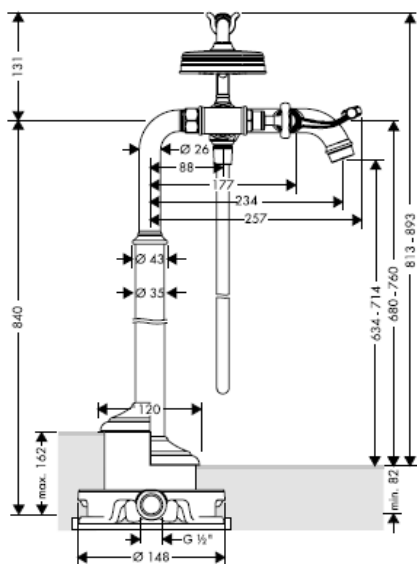

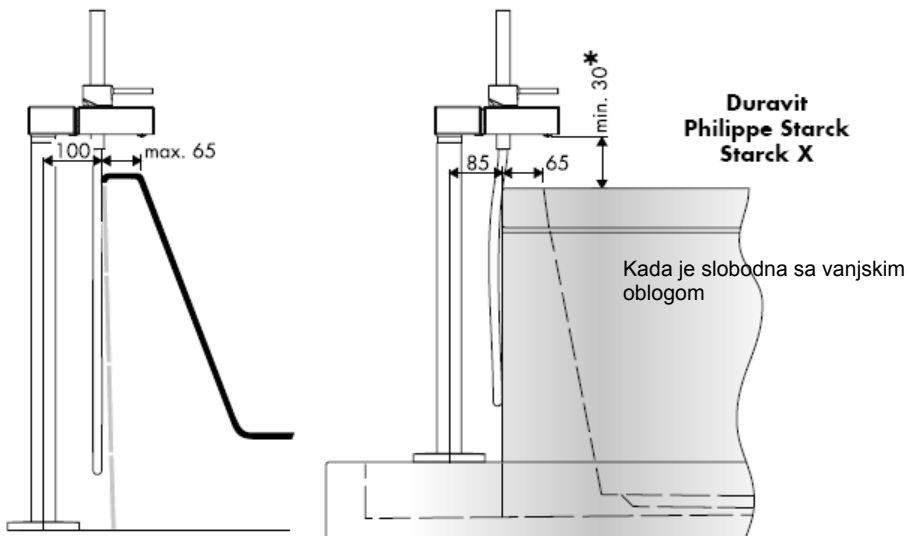

* < 30 min = Produljenje 60 mm (br. Proizvoda 97686000)



Massaud 18450000

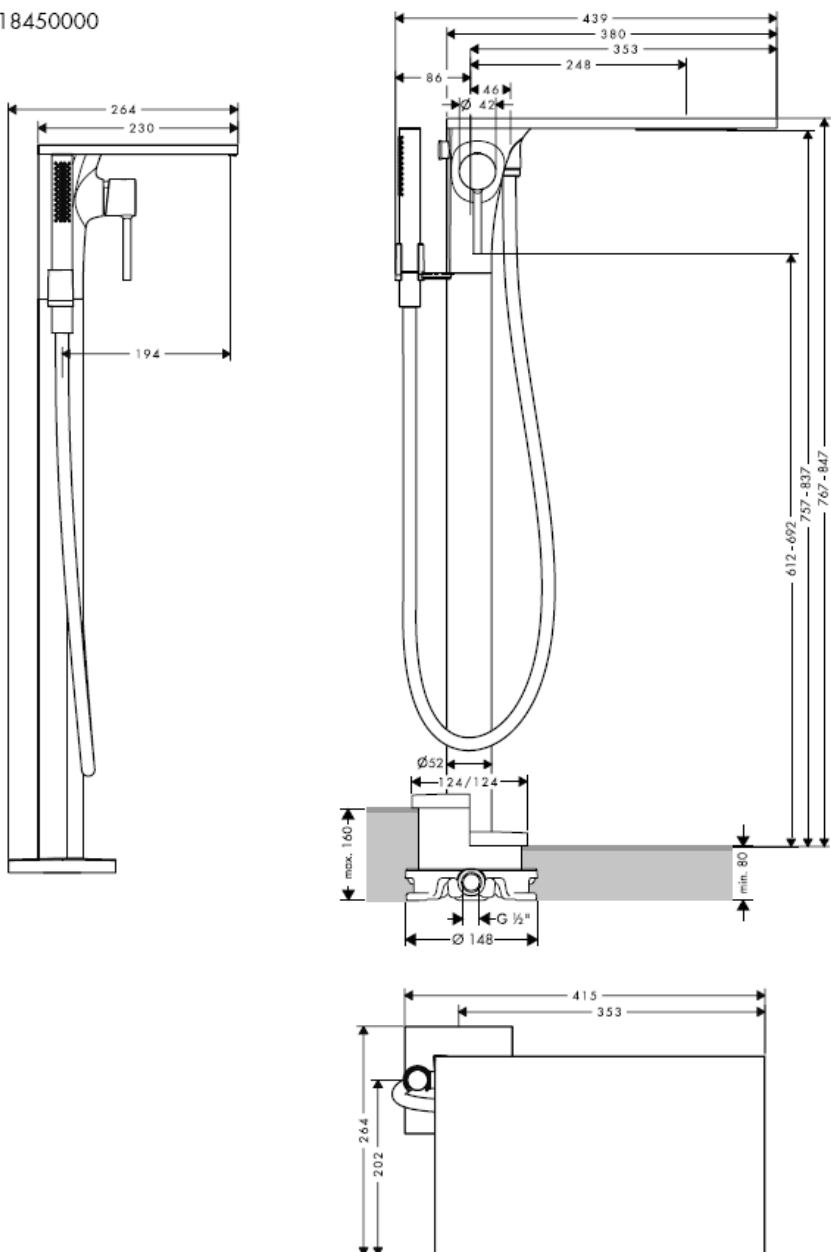

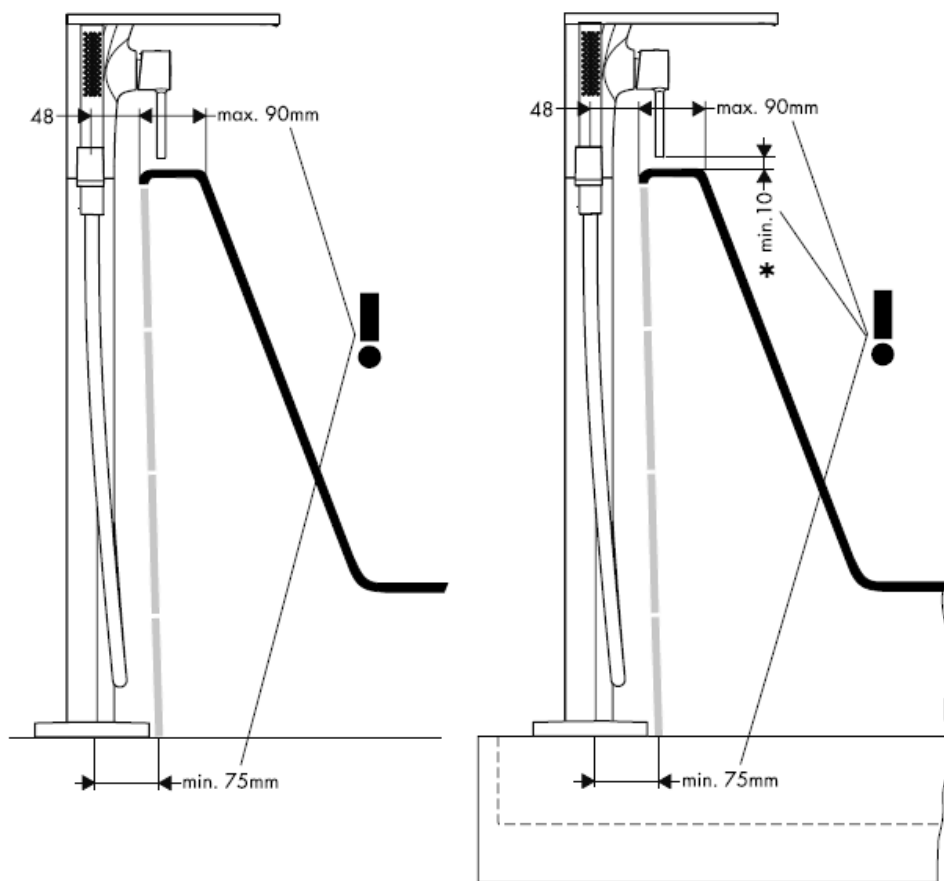

* < 10 min = Produljenje 60 mm (br. Proizvoda 97686000)

Citterio 39451000

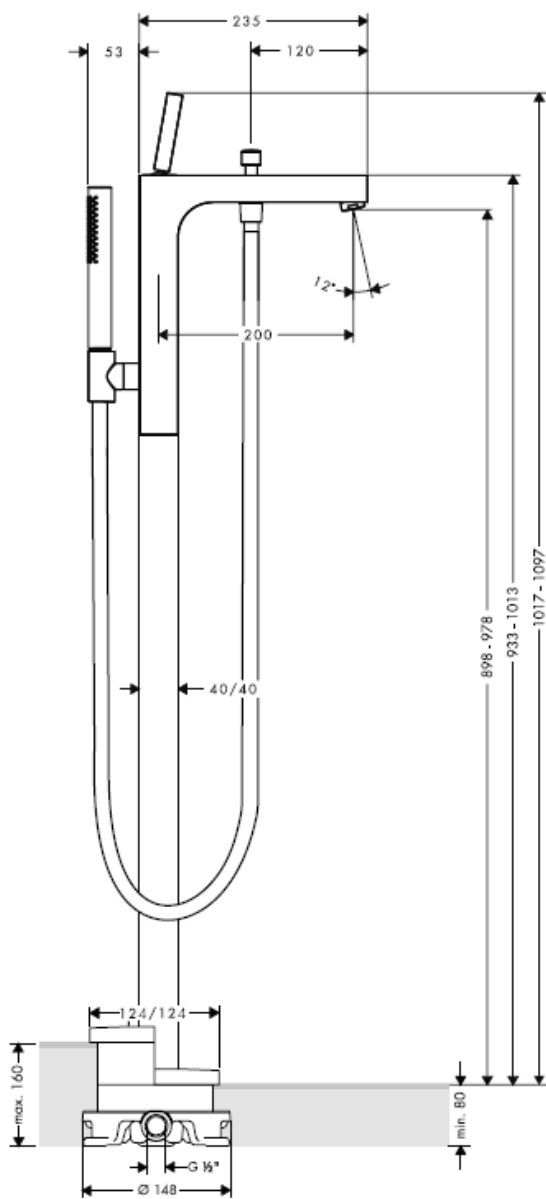

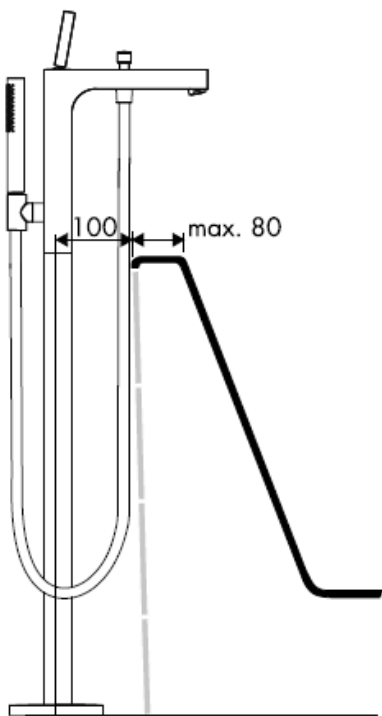

Pažnja! Cijevi moraju biti postavljene, isprane i testirane prema važećim normama!

Starck 10452180

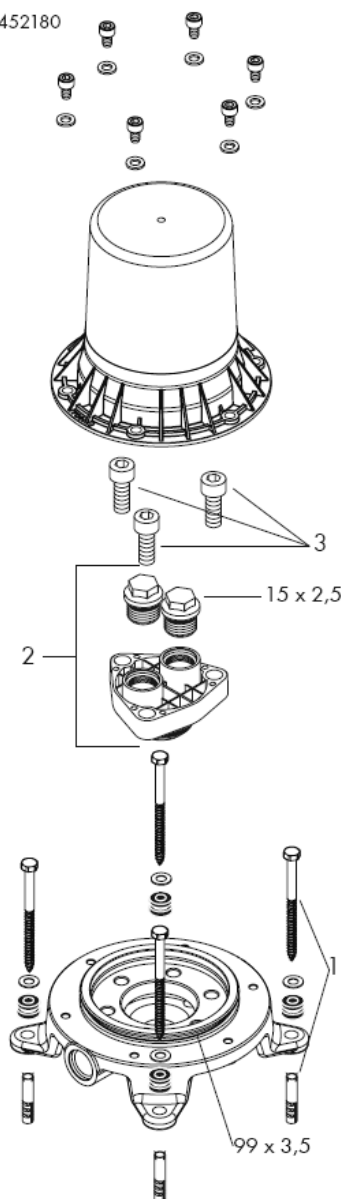

Montreux 16549180

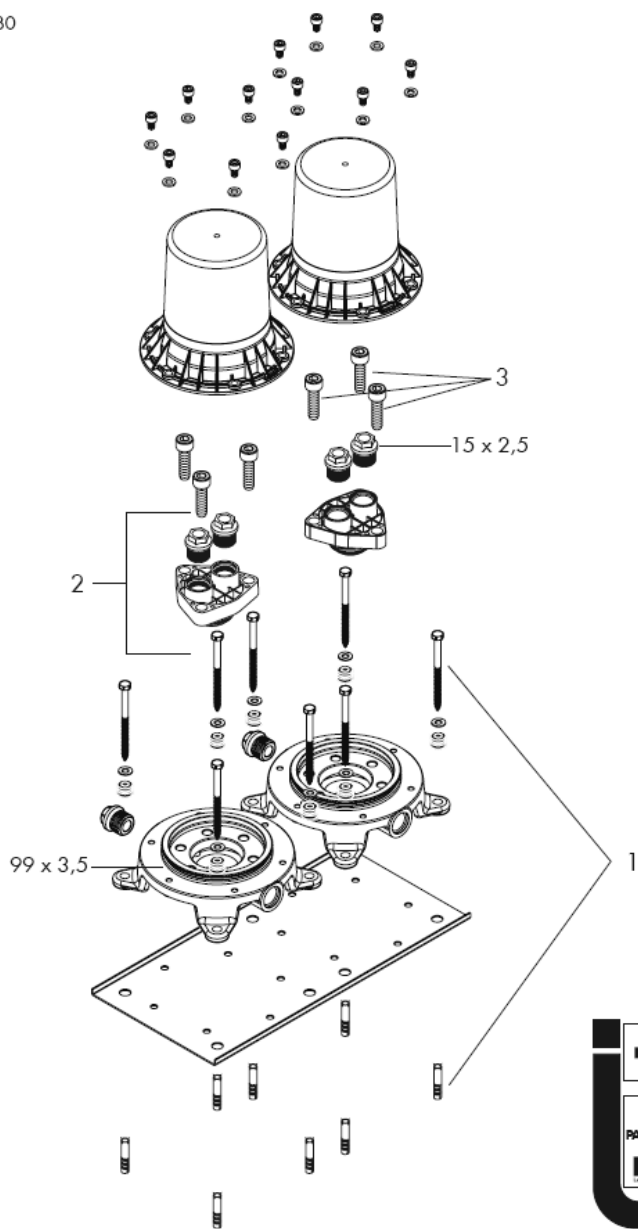

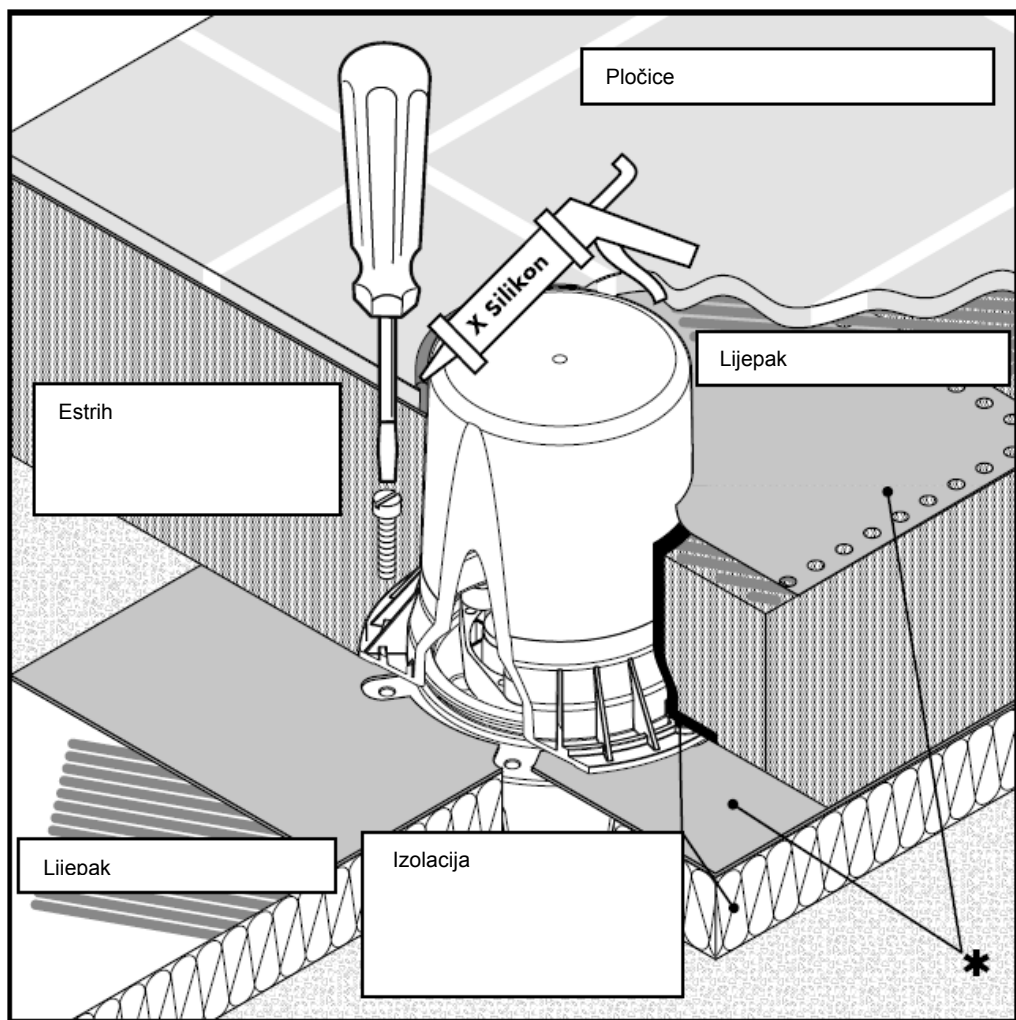

* Manžete za brtvljenje - mogu se naručiti

X Silikon (ne sadrži kiseline)

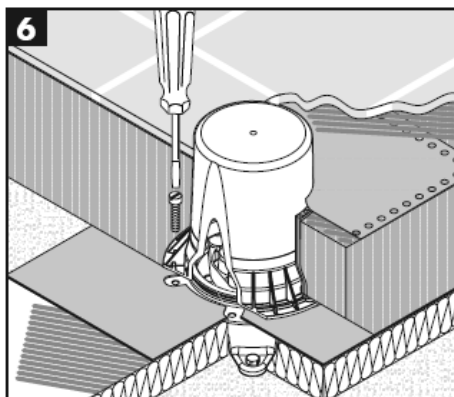
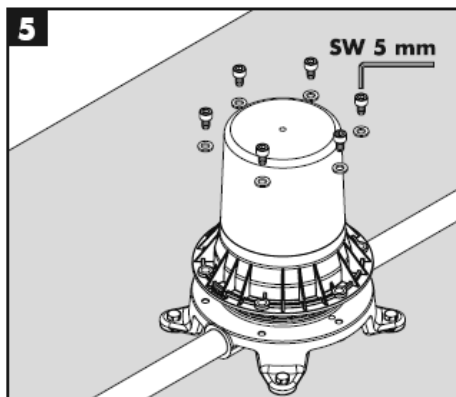
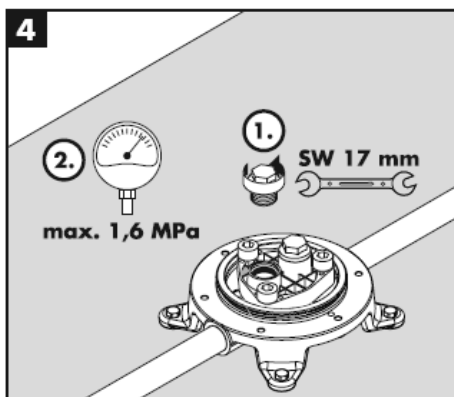
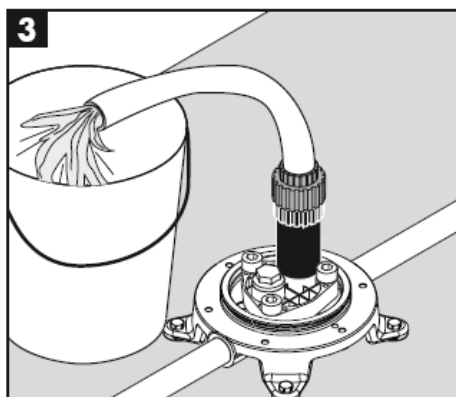
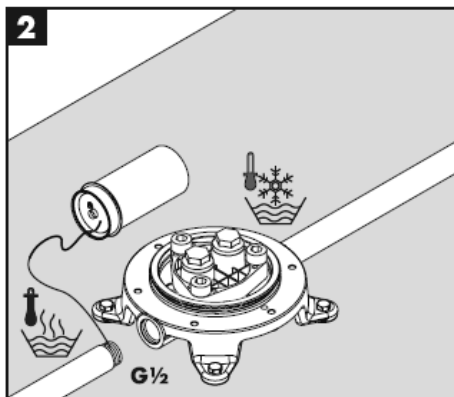
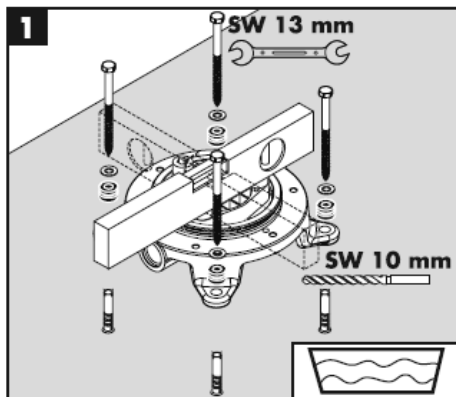

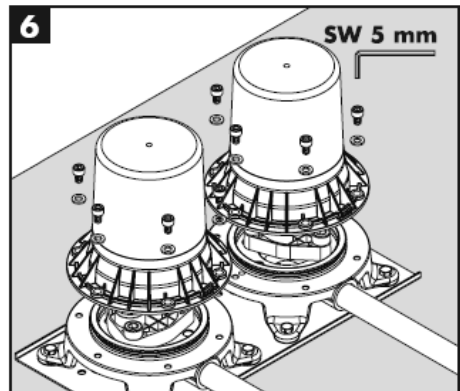
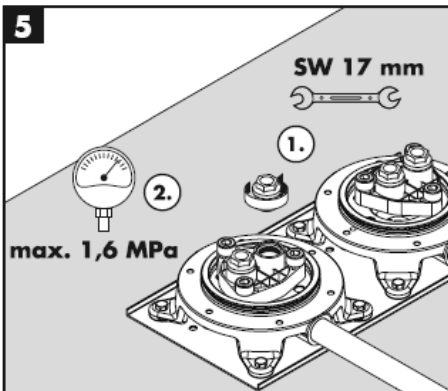
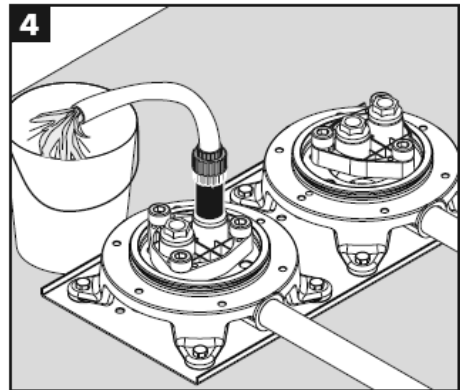
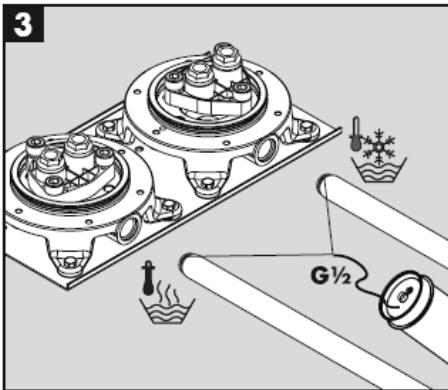
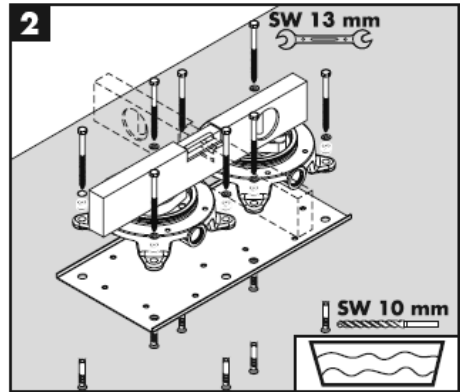
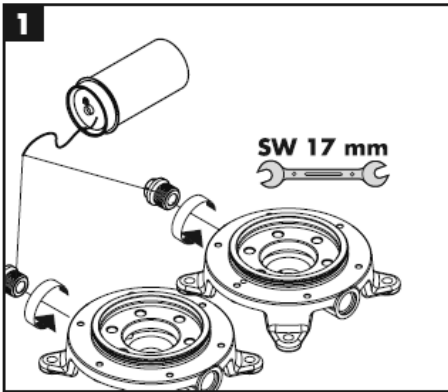

Sastavljanje

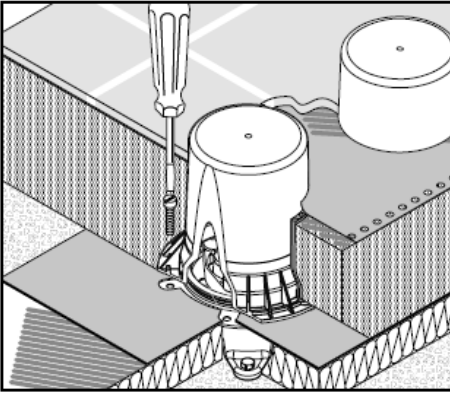

Hrvatski

Tehnički podatci

Najveći dopušteni tlak:	max. 1 MPa
Preporučeni tlak:	0,1 – 0,5 MPa
Probni tlak:	1,6 MPa
(1 MPa = 10 bar = 147 PSI)	
Temperatura vruće vode:	max. 80° C
Preporučena temperatura vruće vode:	65° C

Rezervni dijelovi pogledaj stranicu 10 – 11

garnitura za pričvršćivanje	96260000
Set brtvi	96459000
valjkasti vijak M 10 x 35	97670000

Posebni pribor

* Manžeta za brtvljenje (Nije sadržano u isporuci!)	96441000
--	----------

Oznaka testiranja

	DVGW	P-IX	SVGW	ACS	NF	WRAS	KIWA
10452180				x		X	
16549180		PA-IX 18729/ICB					

hansgrohe

Montaj kılavuzu

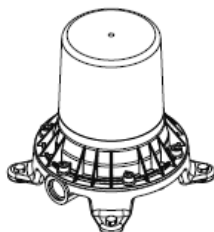

Starck
10452180

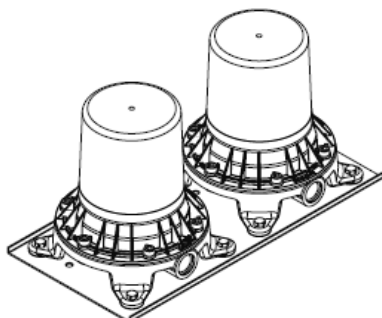

Montreux
16549180

AXOR[®]

hansgrohe

Starck 10458XXX

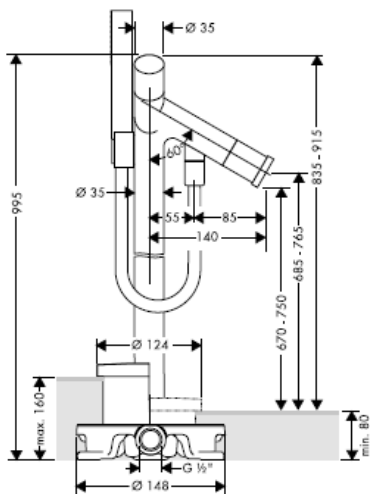

Starck 10060XXX

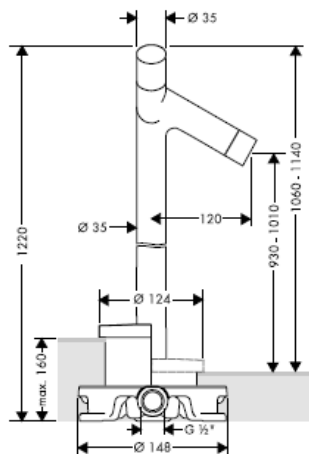

Starck 10456XXX

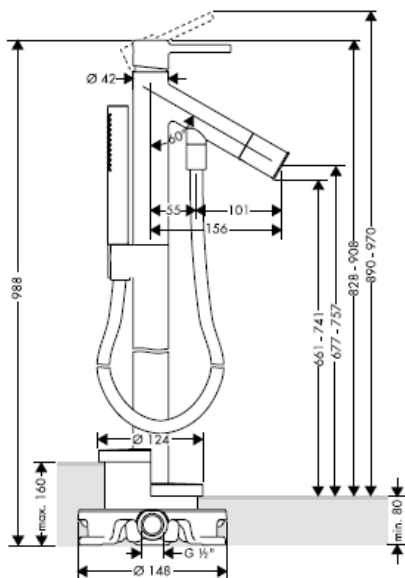

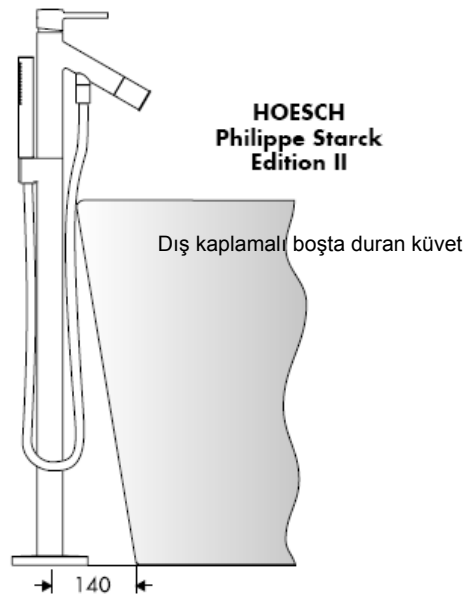
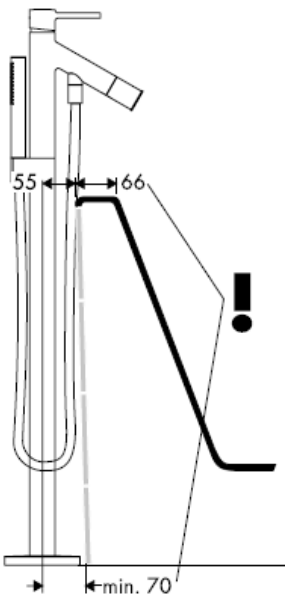
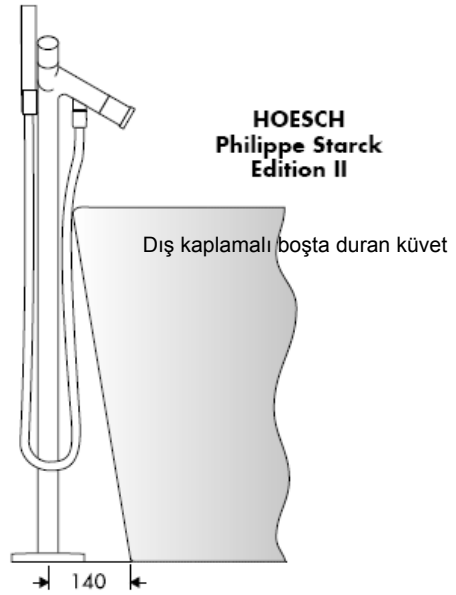
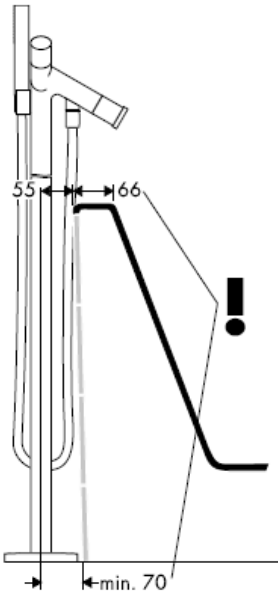

Starck X 10406000

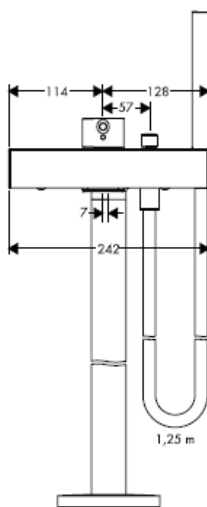
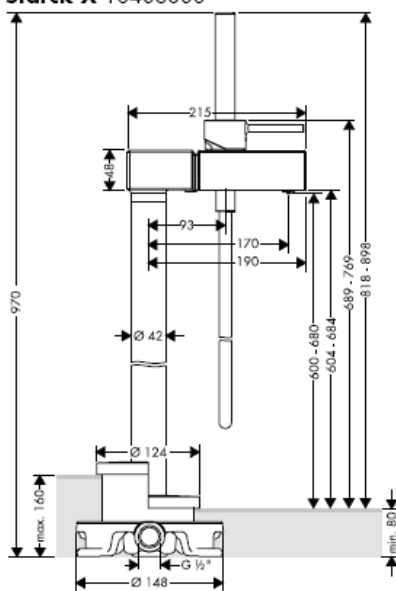

Montreux 16547XXX

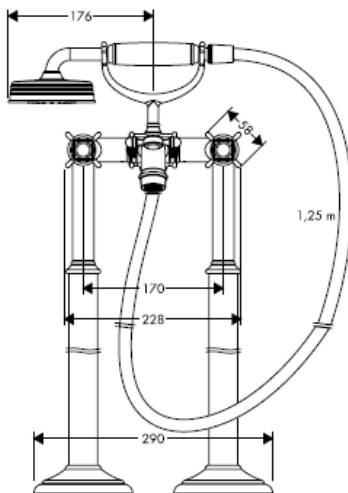
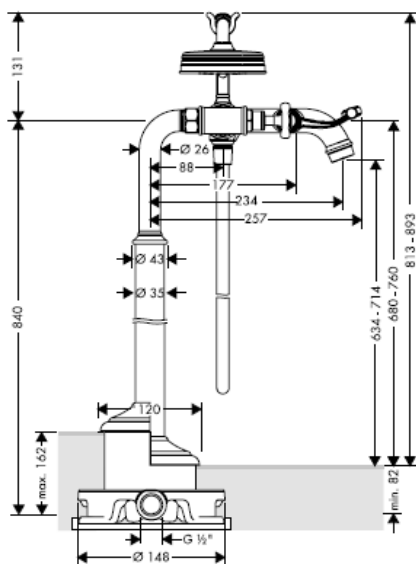

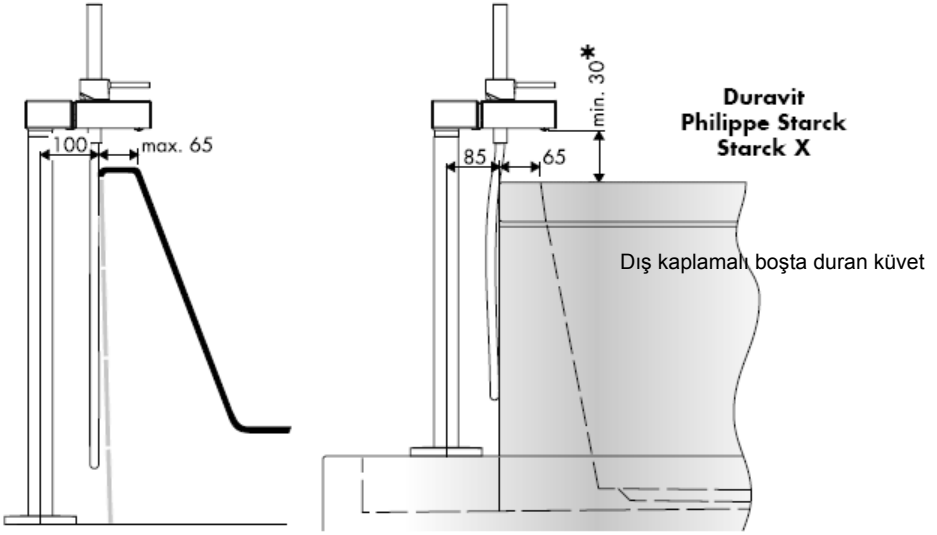

* < 30 min = Uzatma 60 mm (Ürün kodu 97686000)

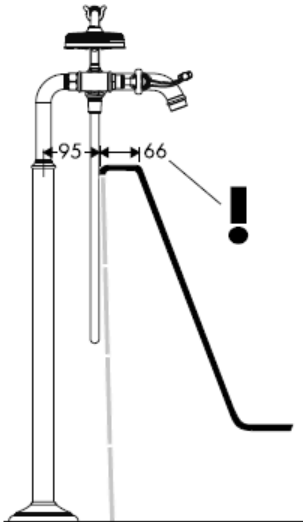

Massaud 18450000

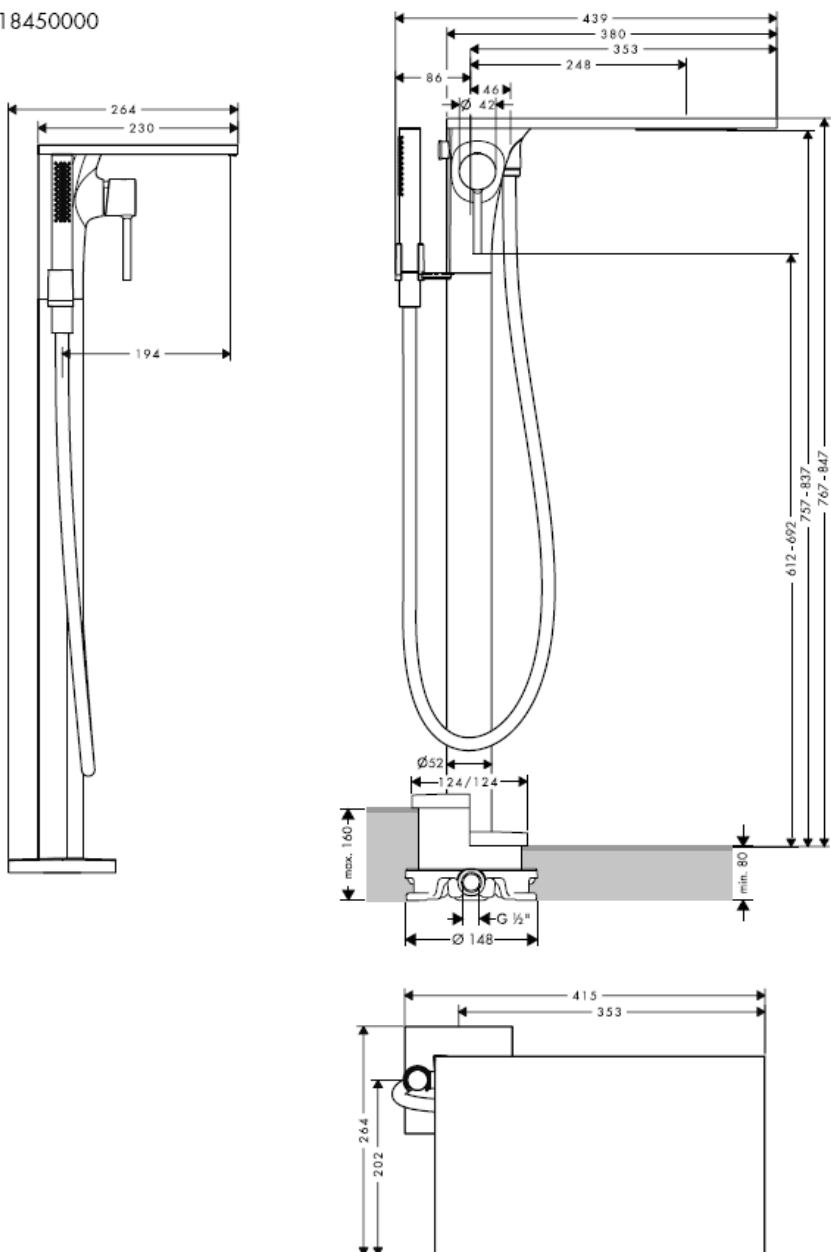

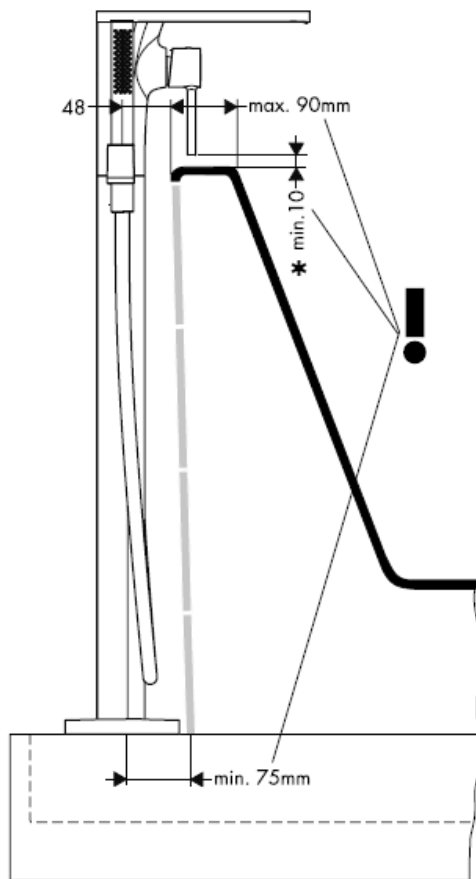
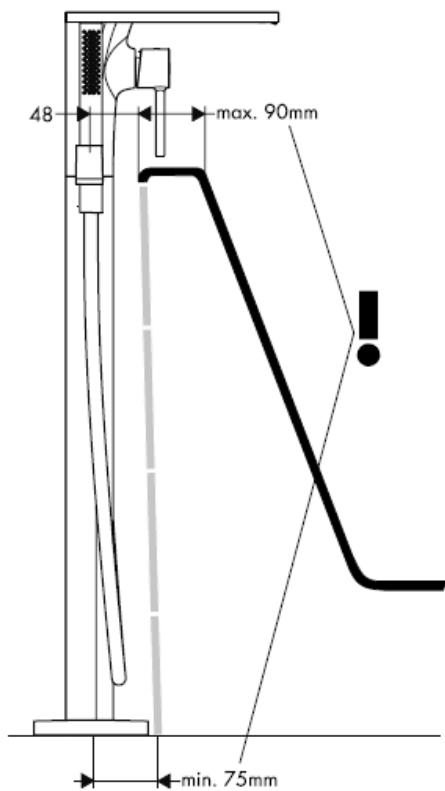

* < 10 min = Uzatma 60 mm (Ürün kodu 97686000)

Citterio 39451000

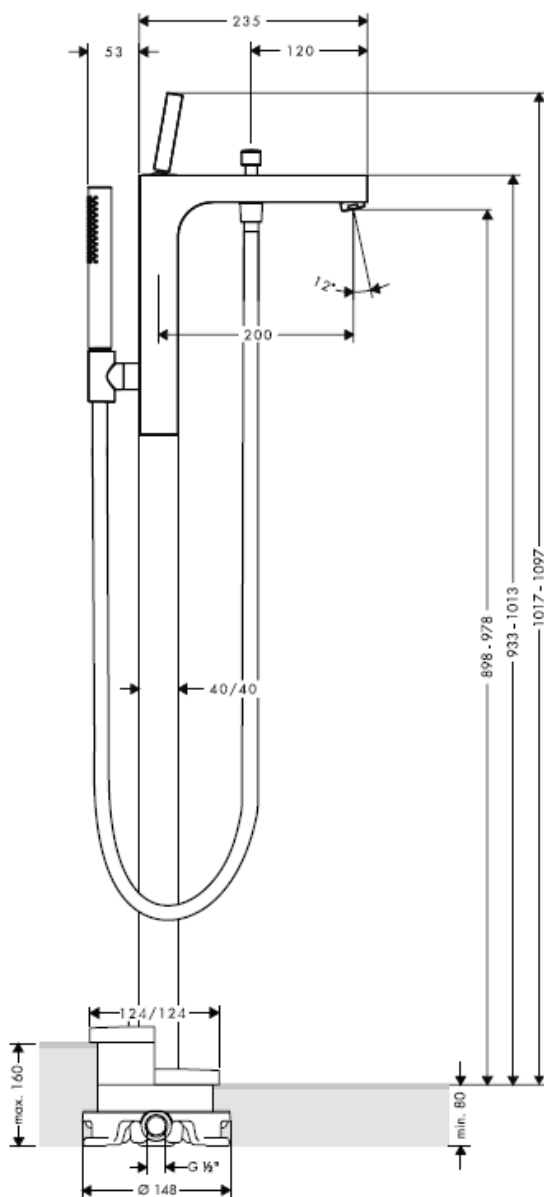

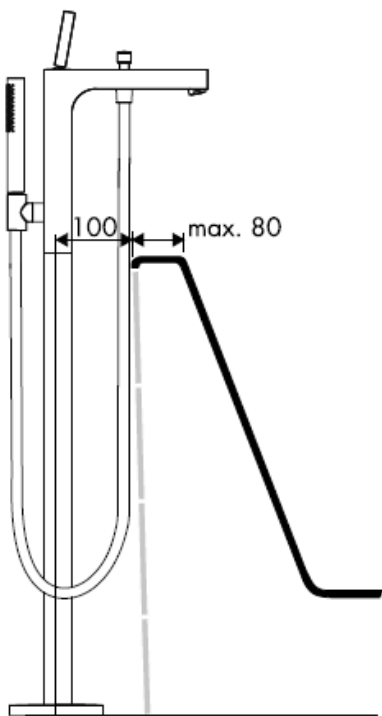

Önemli! Batarya geçerli normlara göre monte edilmeli, yıkanmalı ve kontrol edilmelidir!

Starck 10452180

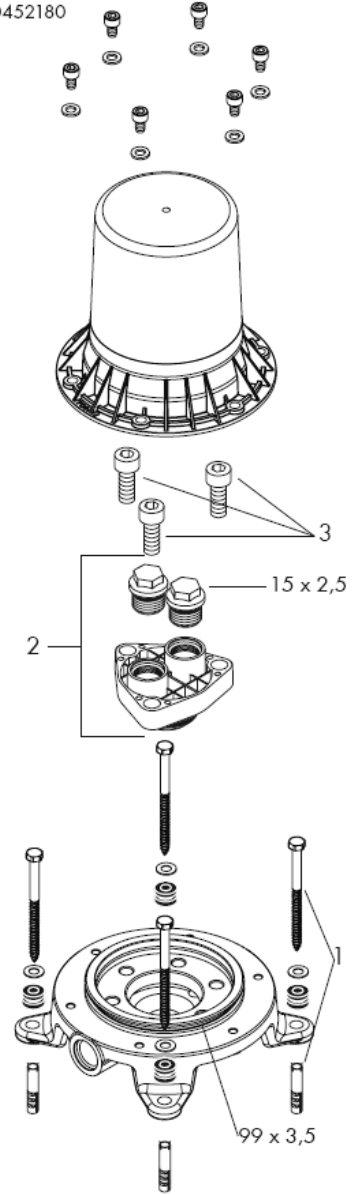

Montreux 16549180

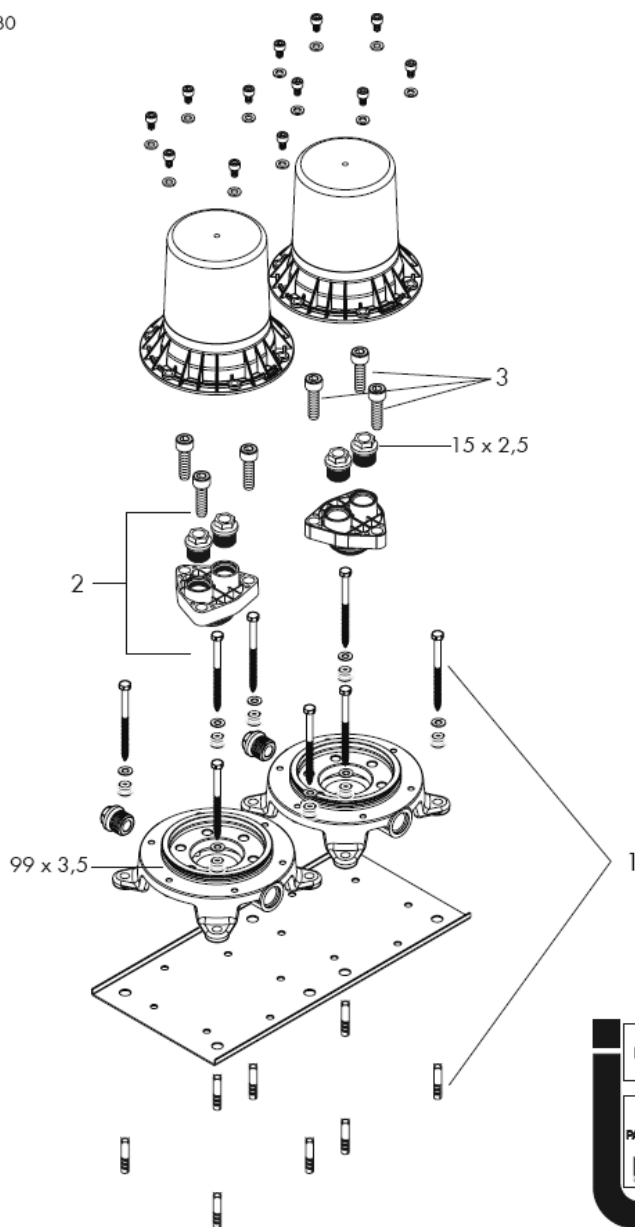

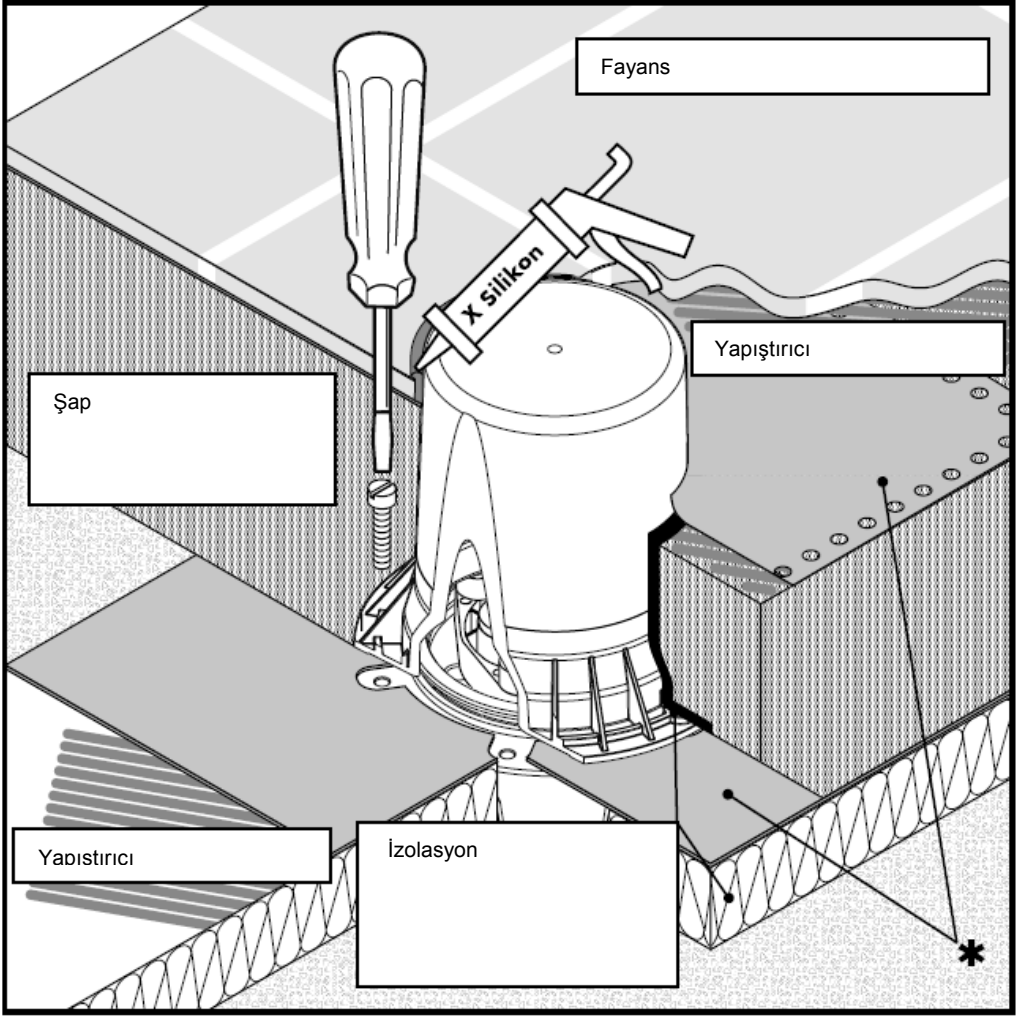

* İsteğe bağlı temin edilebilen sızdırmazlık

X Silikon (asetik asit içermeyen)

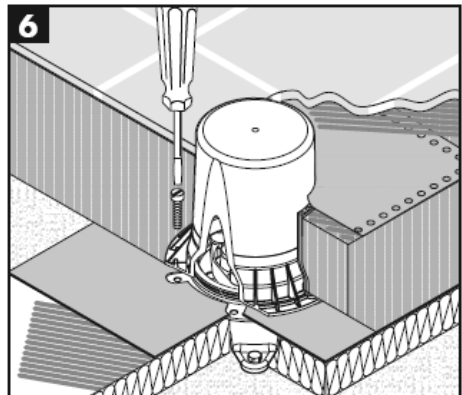
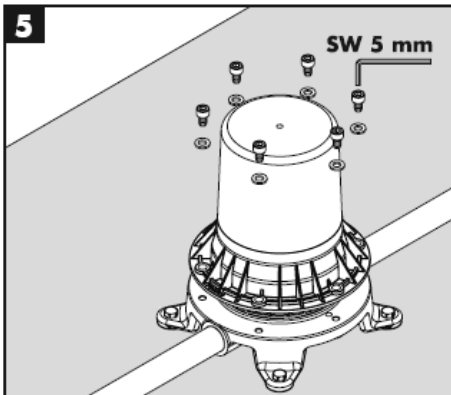
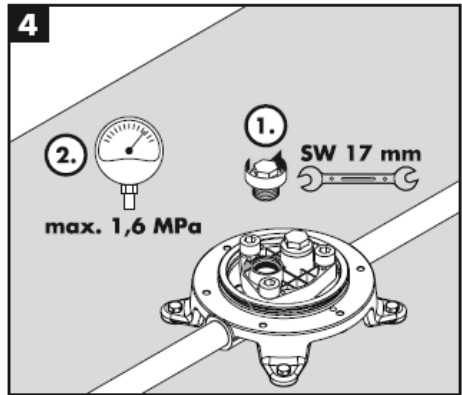
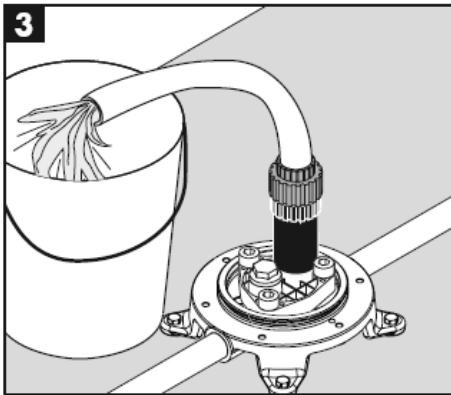
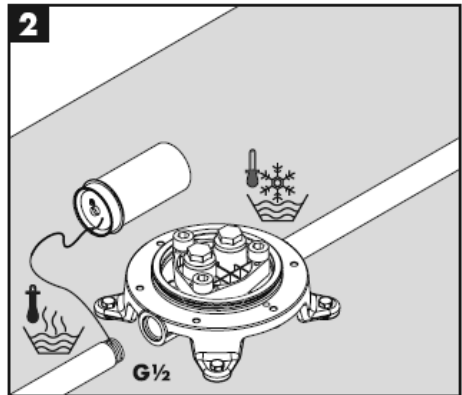
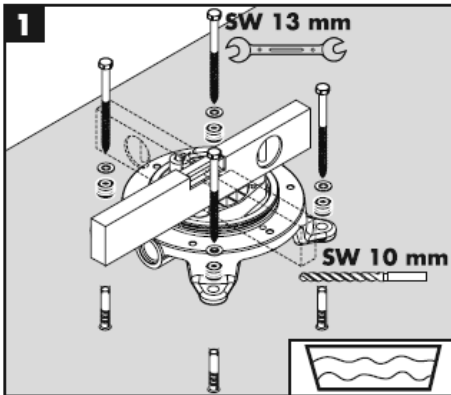

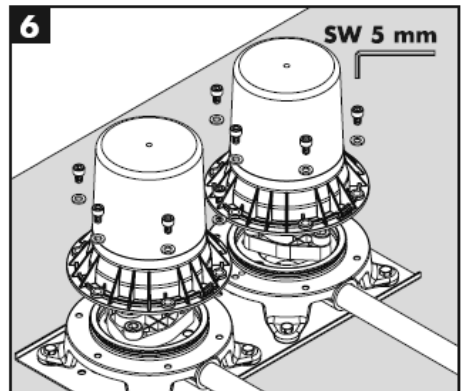
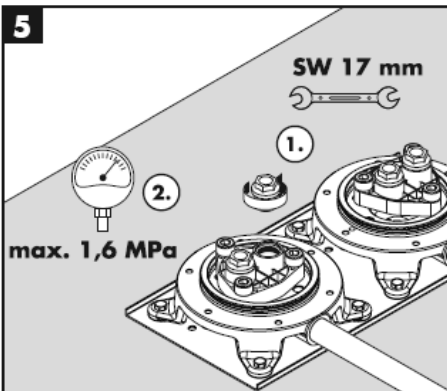
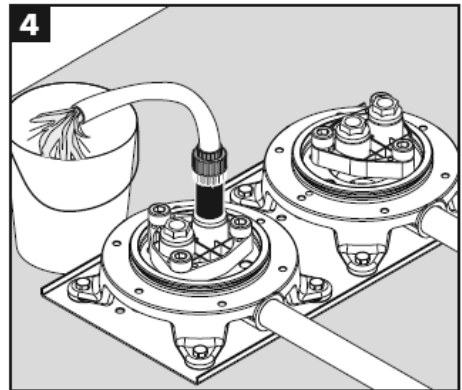
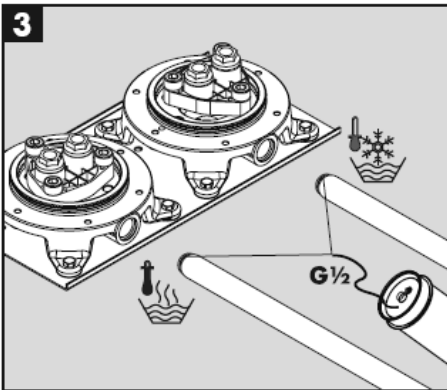
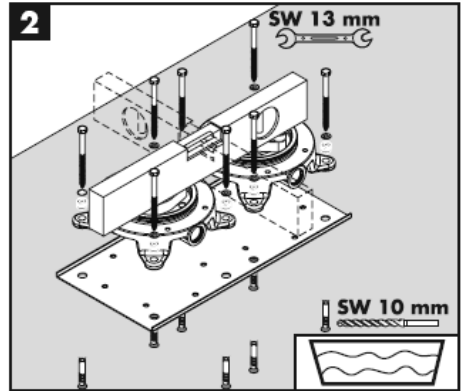
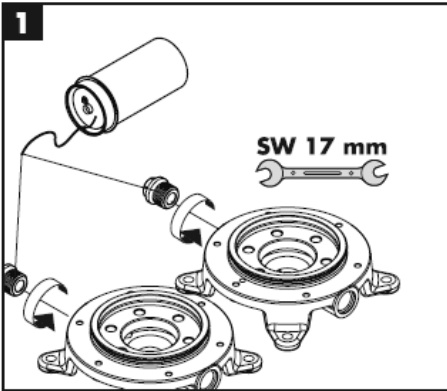

Montajı

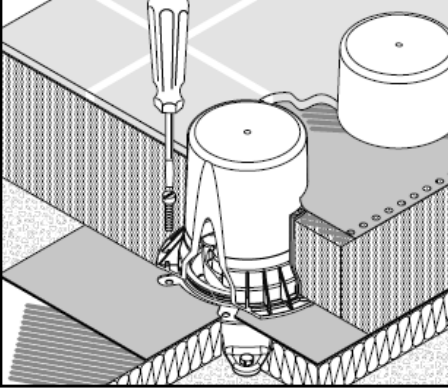

Türkçe

Teknik bilgiler

İşletme basıncı:	max. 1 MPa
Tavsiye edilen işletme basıncı:	0,1 – 0,5 MPa
Kontrol basıncı:	1,6 MPa
(1 MPa = 10 bar = 147 PSI)	
Sıcak su sıcaklığı:	max. 80° C
Tavsiye edilen su ısısı:	65° C

Yedek Parçalar Bakınız sayfa 10 – 11

Sabitleme seti	96260000
Conta seti	96459000
Silindirik vida M 10 x 35	97670000

Özel aksesuarlar

* Sızdırmazlık manşeti	96441000
(Teslimat kapsamına dahil değildir)	

Kontrol işareti

DVGW	P-IX	SVGW	ACS	NF	WRAS	KIWA
10452180			x		X	
16549180	PA-IX 18729/ICB					

hansgrohe

Instrucțiuni de montare

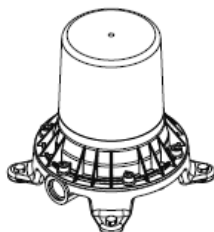

Starck
10452180

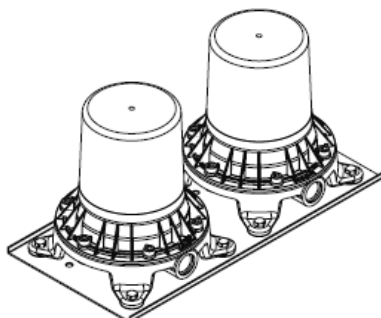

Montreux
16549180

AXOR[®]

hansgrohe

Starck 10458XXX

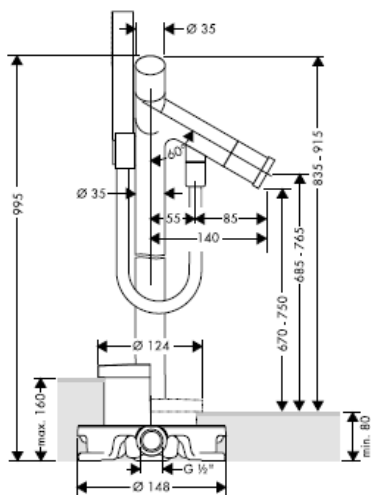

Starck 10060XXX

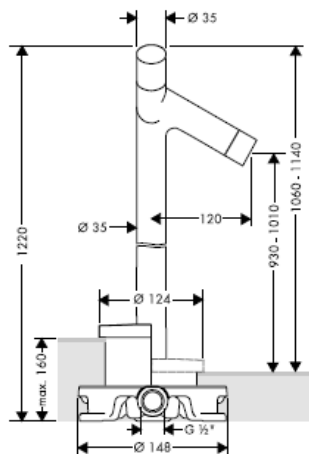

Starck 10456XXX

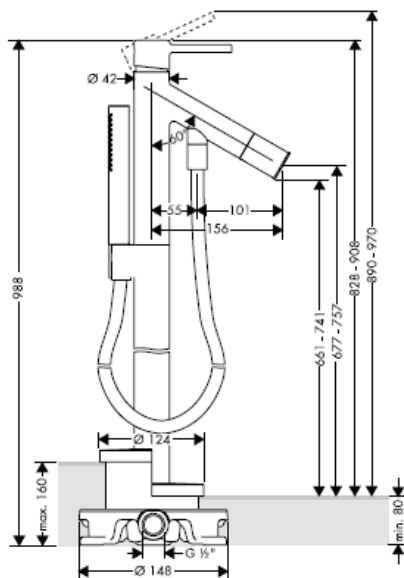

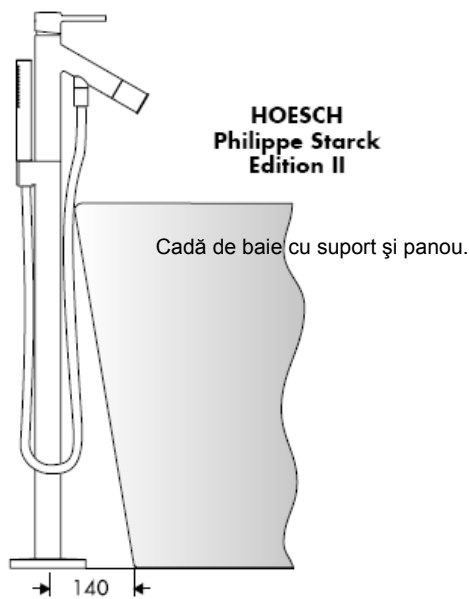
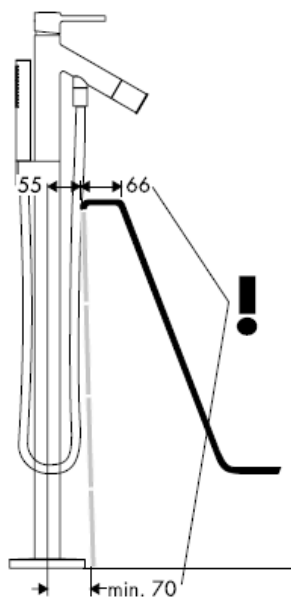
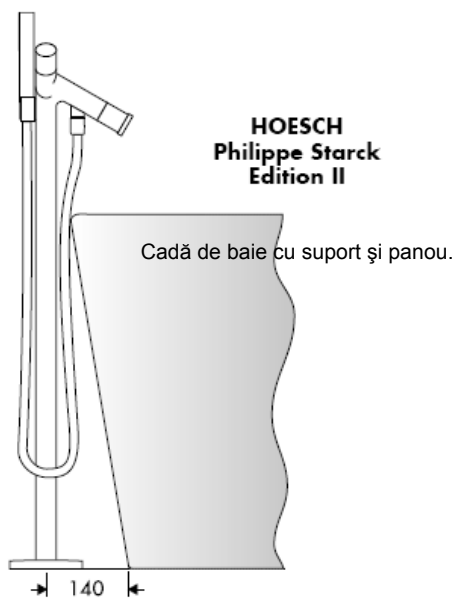

Starck X 10406000

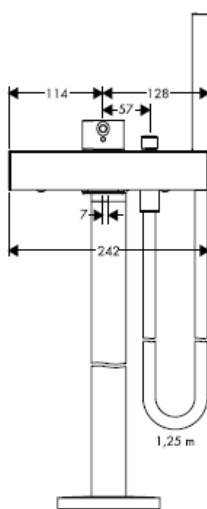
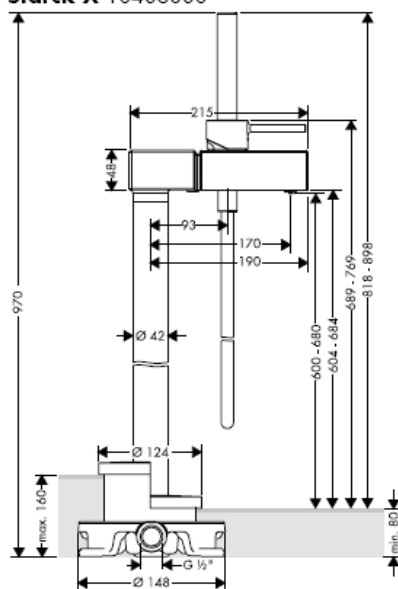

Montreux 16547XXX

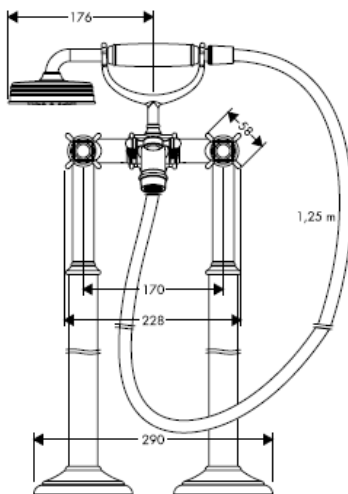
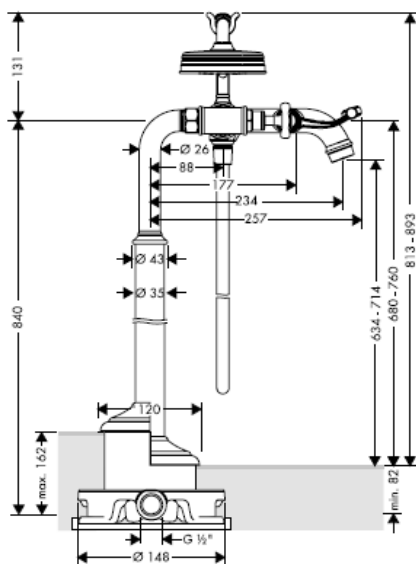

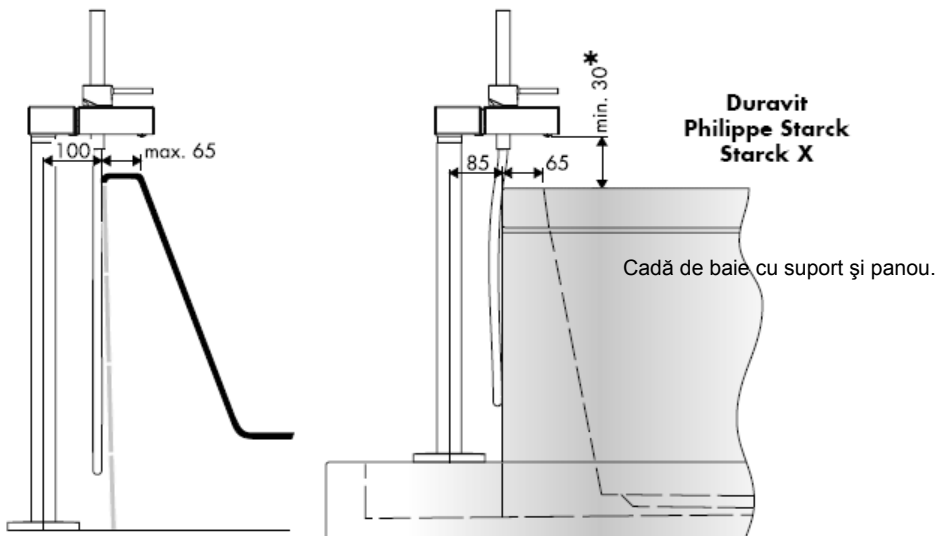

* < 30 min = Prelungitor 60 mm (Nr. produs 97686000)



Massaud 18450000

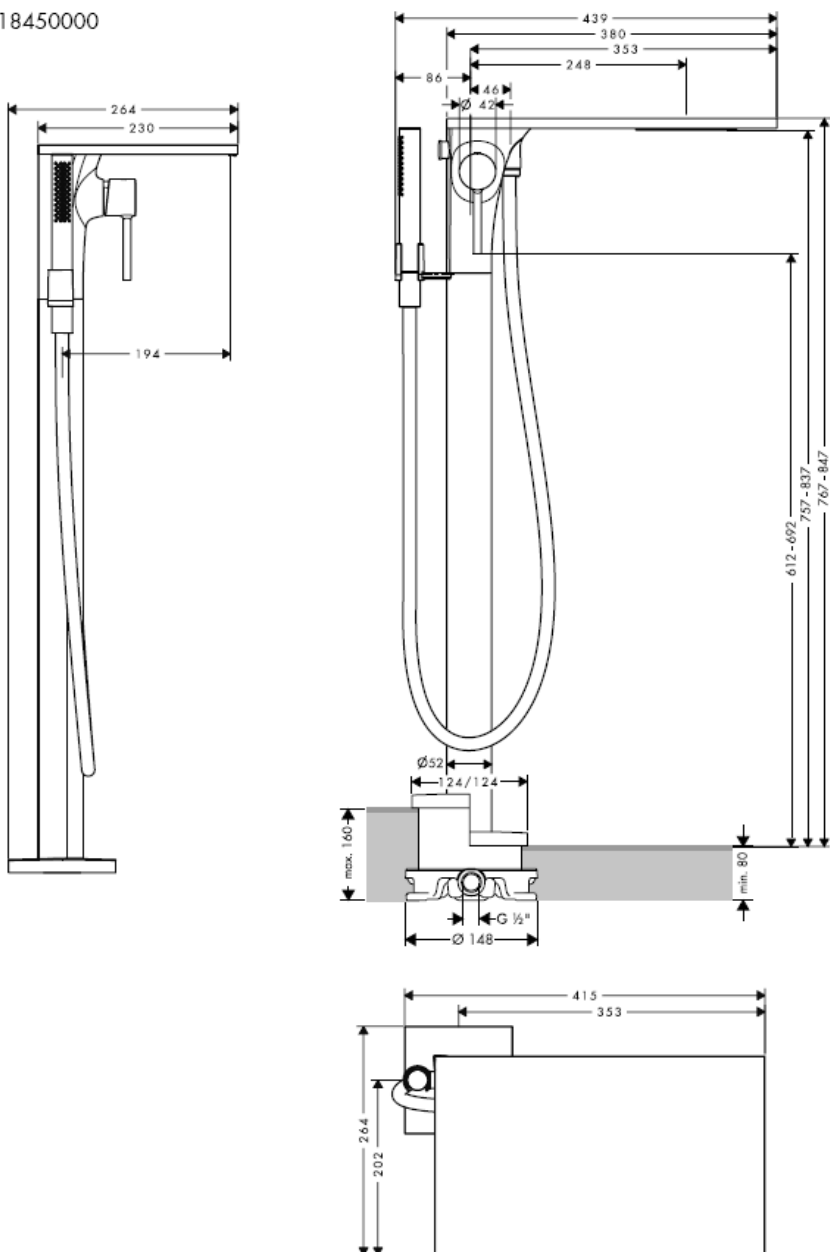

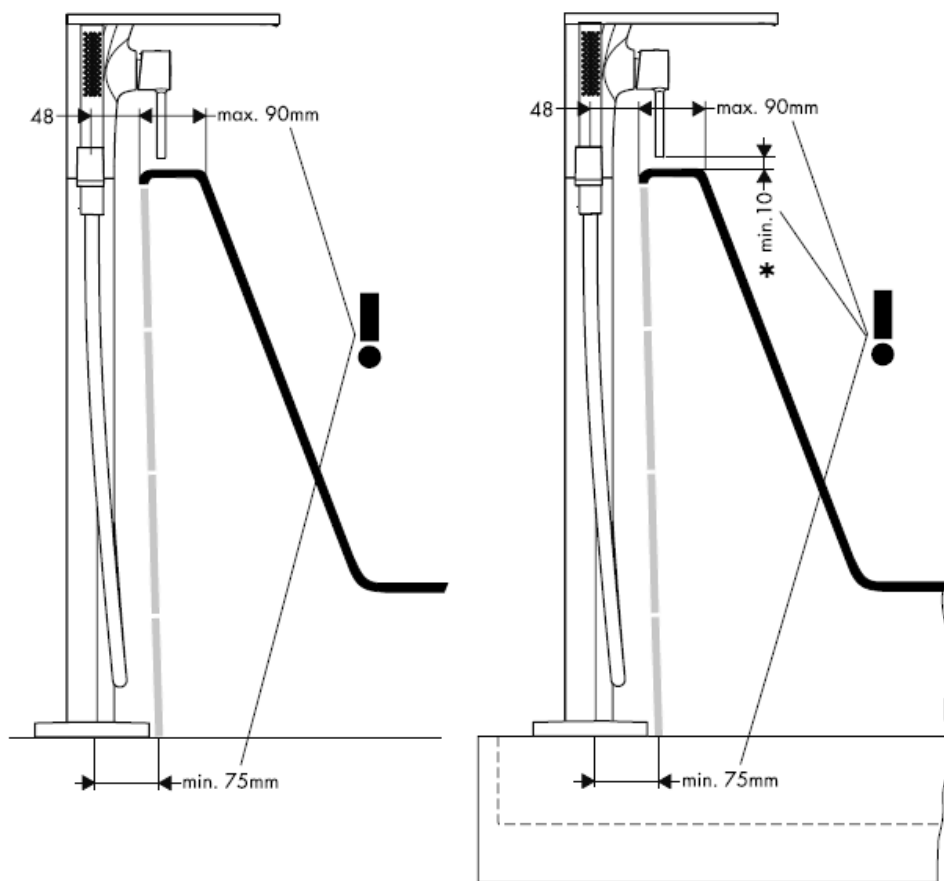

* < 10 min = Prelungitor 60 mm (Nr. produs 97686000)

Citterio 39451000

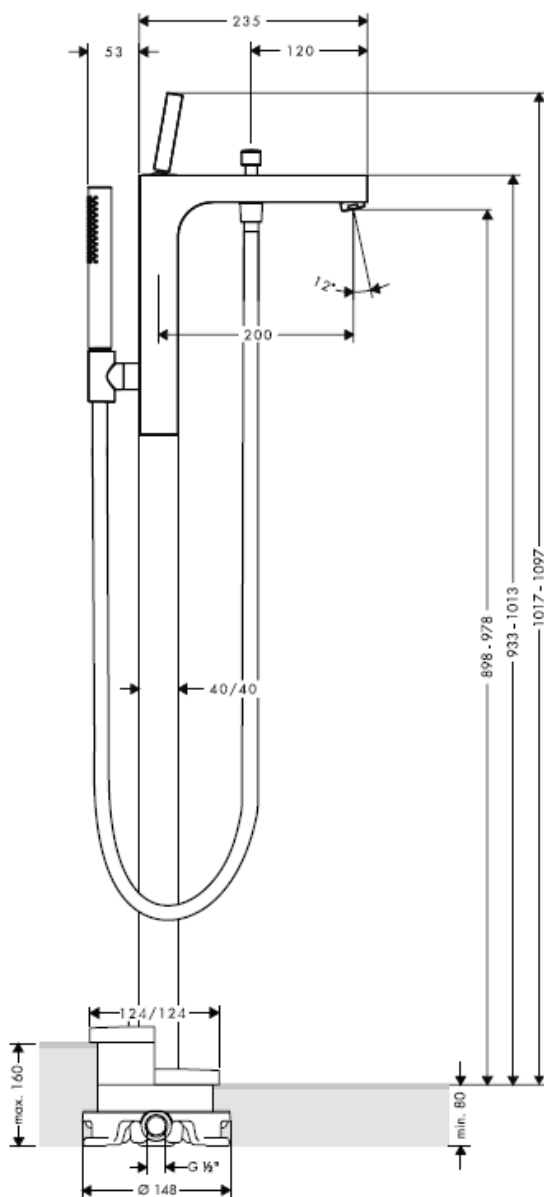

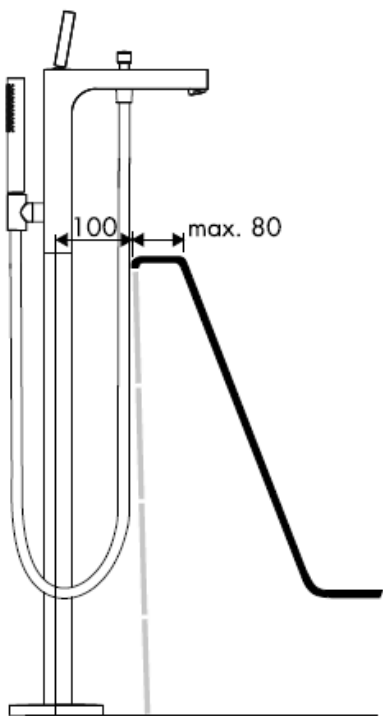

Atenție! Bateria trebuie montată, clătită și verificată conform normelor în vigoare.

Starck 10452180

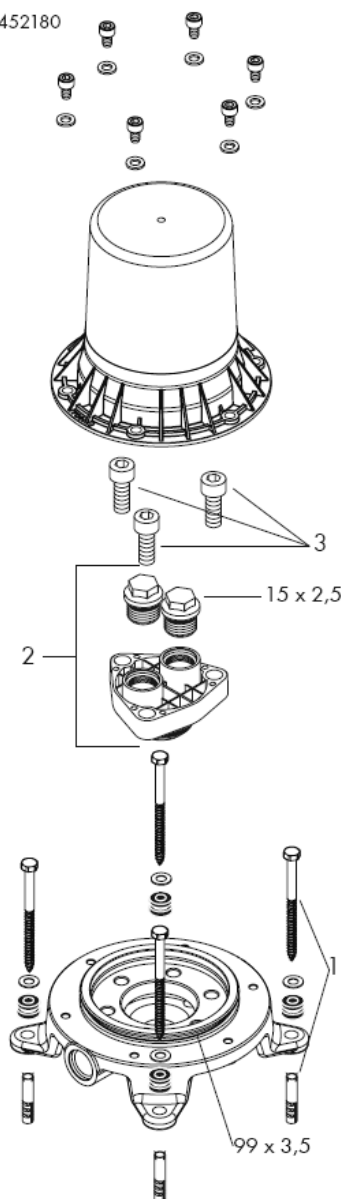

Montreux 16549180

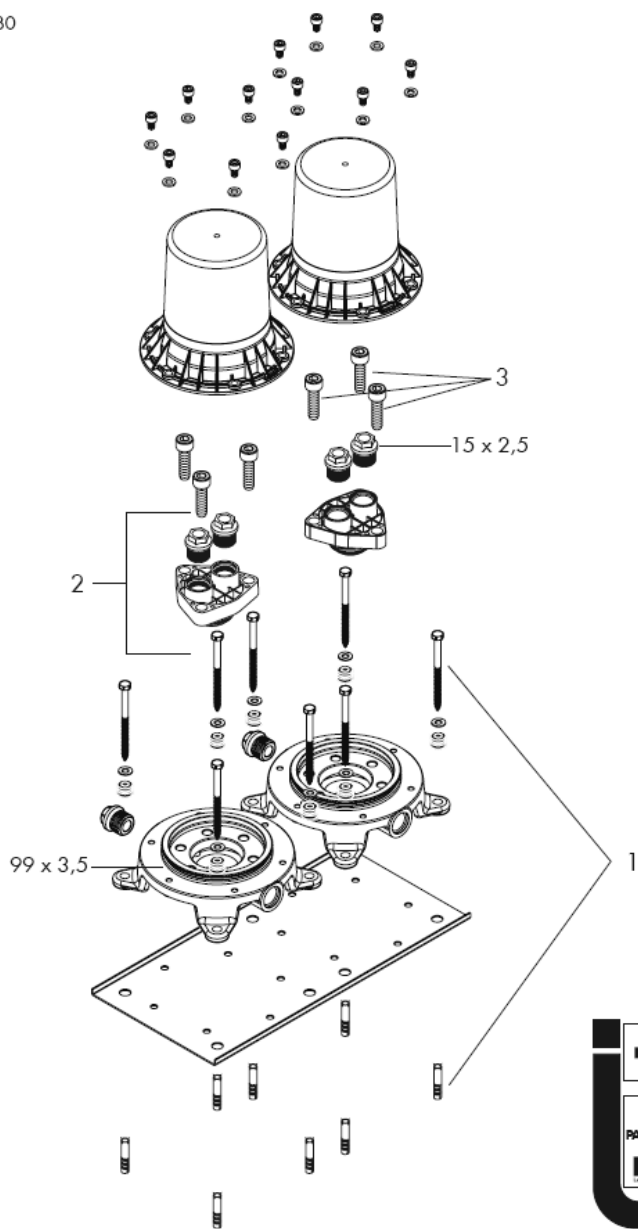

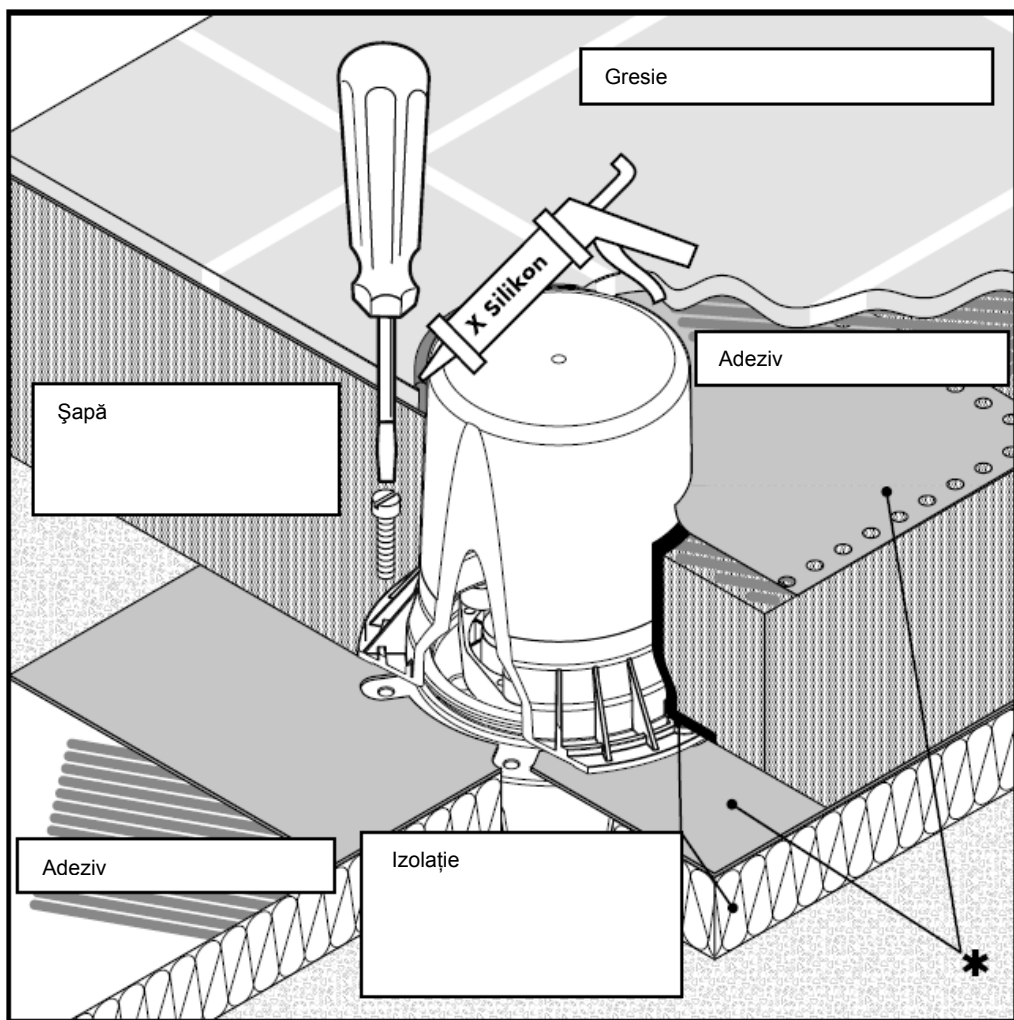

* manșetă de etanșare opțională

X Silikon (fără acid acetic!)

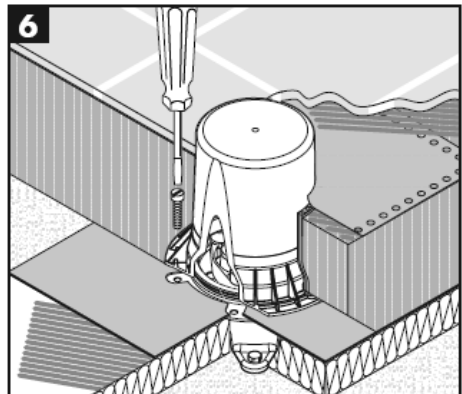
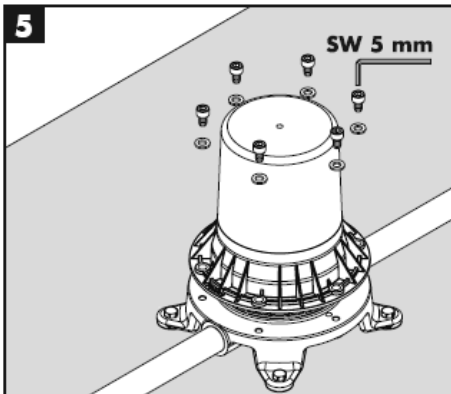
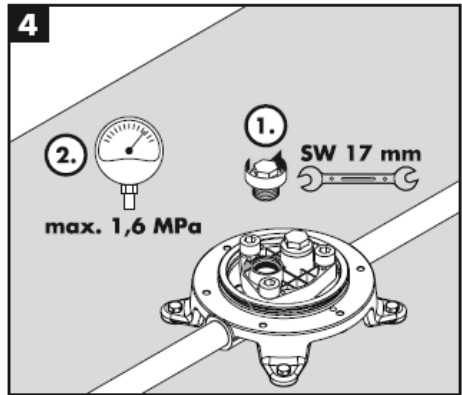
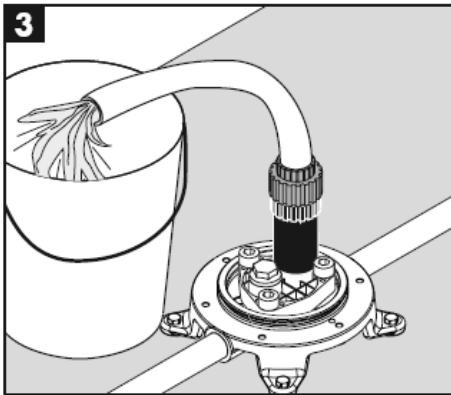
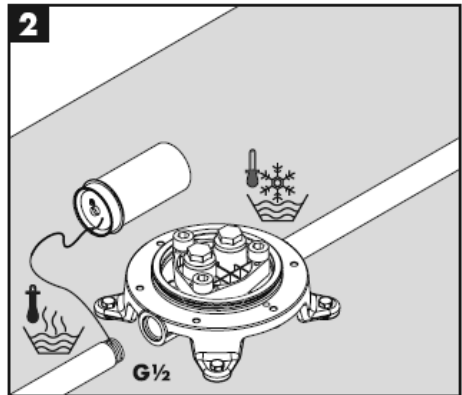
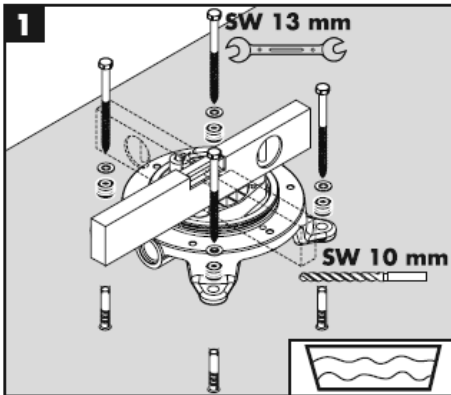

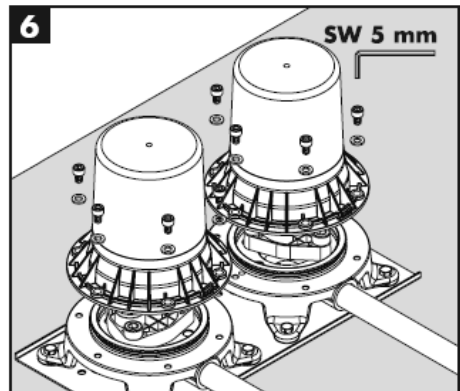
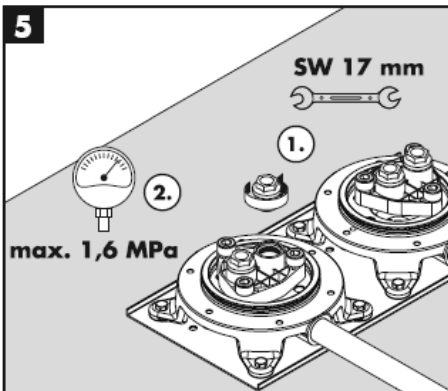
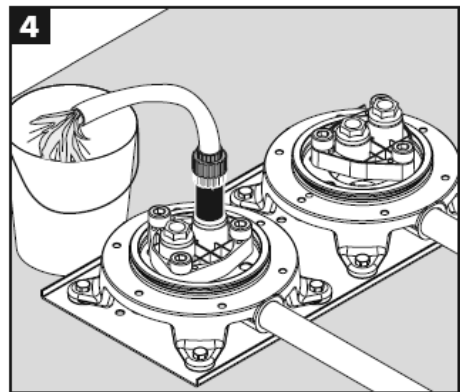
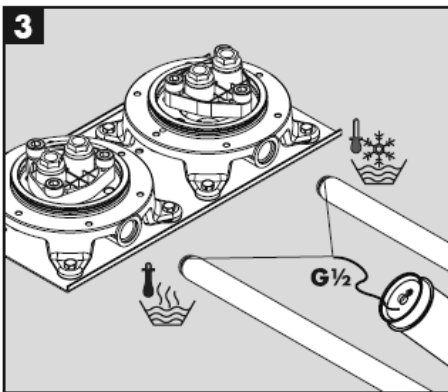
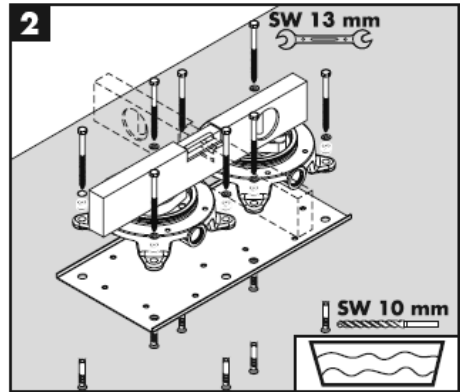
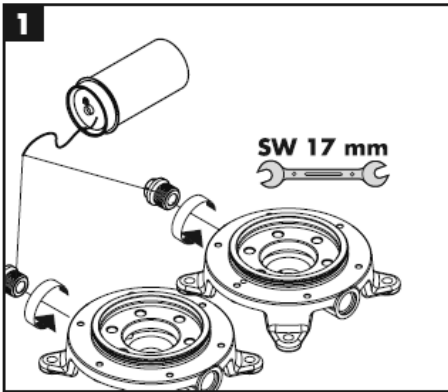

Montare

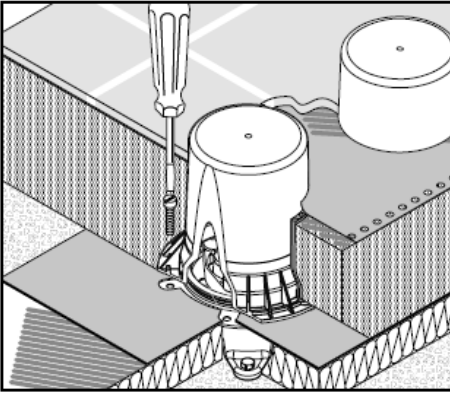

Română

Date tehnice

Presiune de funcționare: max. 1 MPa
Presiune de funcționare recomandată: 0,1 – 0,5 MPa
Presiune de verificare: 1,6 MPa
(1 MPa = 10 bar = 147 PSI)
Temperatura apei calde: max. 80° C
Temperatura recomandată a apei calde: 65° C

Piese de schimb vezi pag. 10 – 11

Garnitură de fixare 96260000
Set de garnituri 96459000
Șurub cilindric M 10 x 35 97670000

Accesorii opționale

* Manșetă de etanșare 96441000
(nu este inclus în setul livrat)

Certificat de testare

	DVGW	P-IX	SVGW	ACS	NF	WRAS	KIWA
10452180				x		X	
16549180		PA-IX 18729/ICB					

hansgrohe

Οδηγία συναρμολόγησης

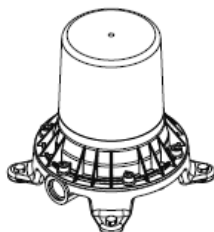

Starck
10452180

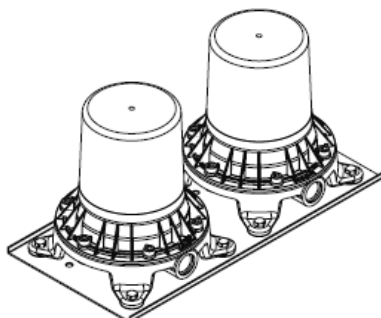

Montreux
16549180

AXOR[®]

hansgrohe

Starck 10458XXX

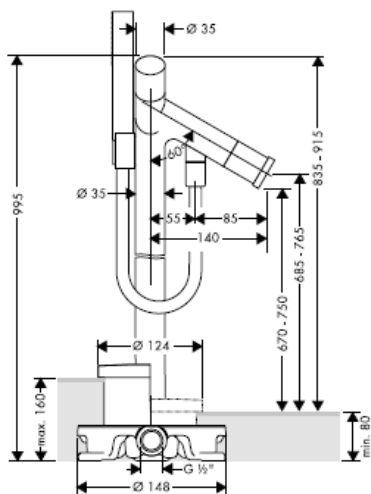

Starck 10060XXX

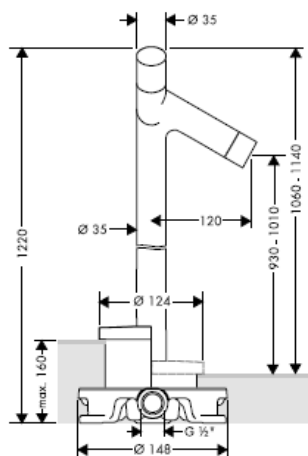

Starck 10456XXX

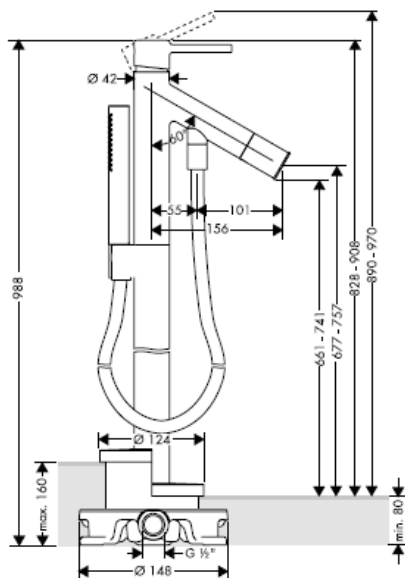

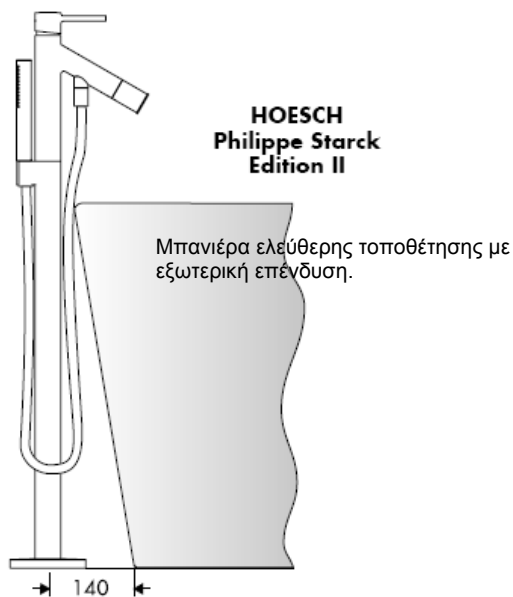
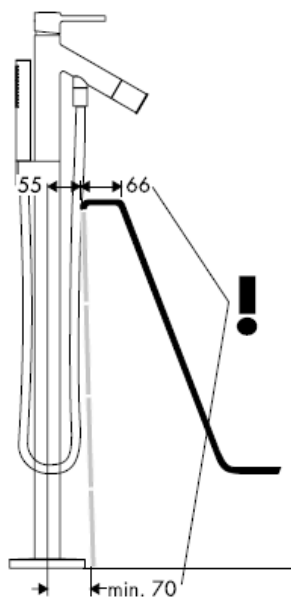
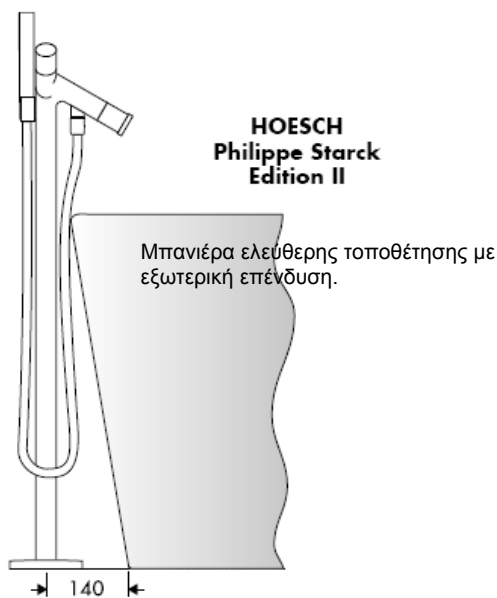

Starck X 10406000

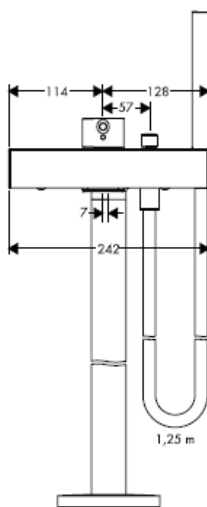
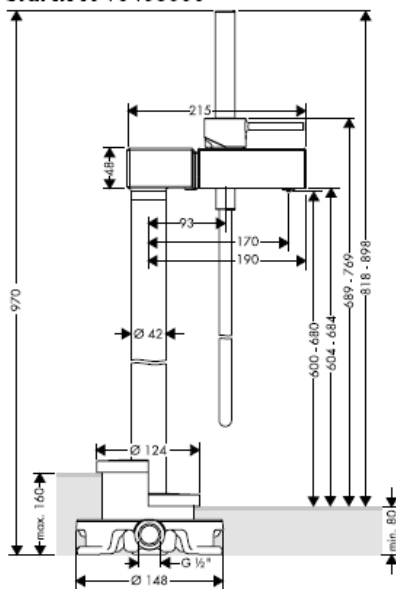

Montreux 16547XXX

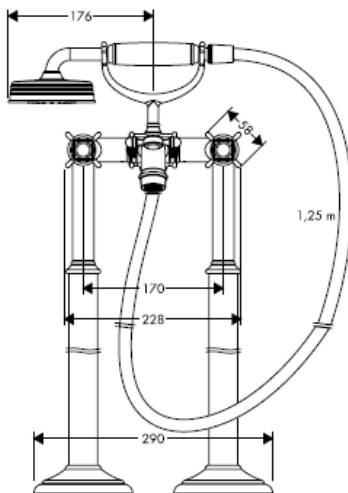
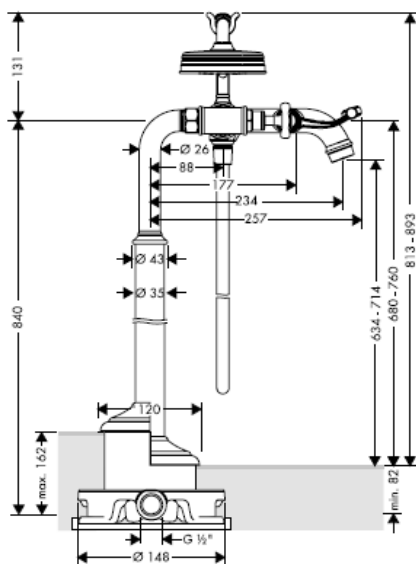

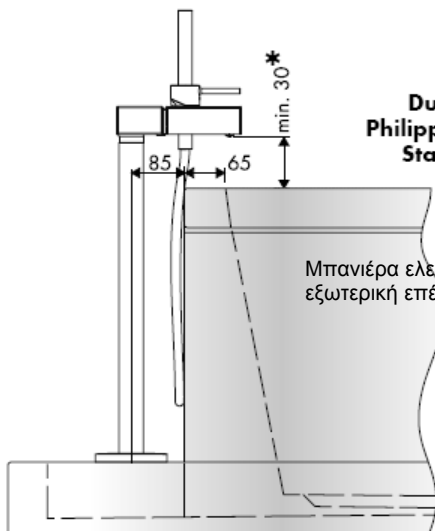
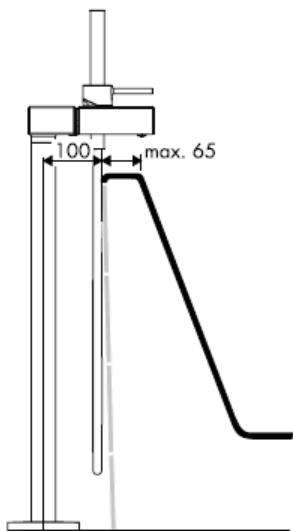

**Duravit
Philippe Starck
Starck X**

Μπανιέρα ελεύθερης τοποθέτησης με εξωτερική επένδυση.

* < 30 min = Επιμήκυνση 60 mm (αρ. είδους 97686000)

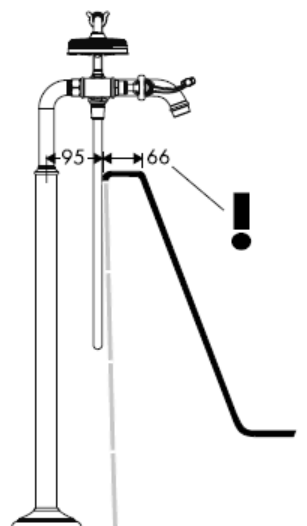

Massaud 18450000

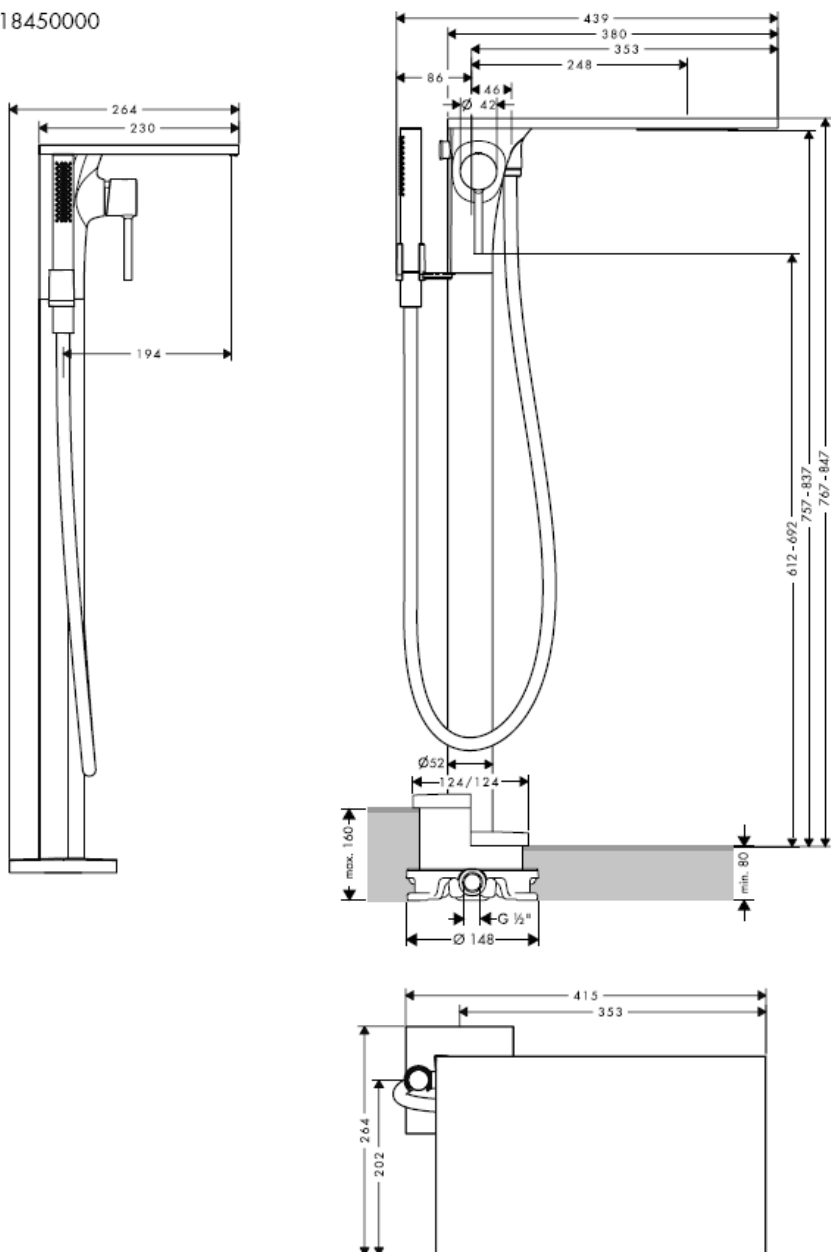

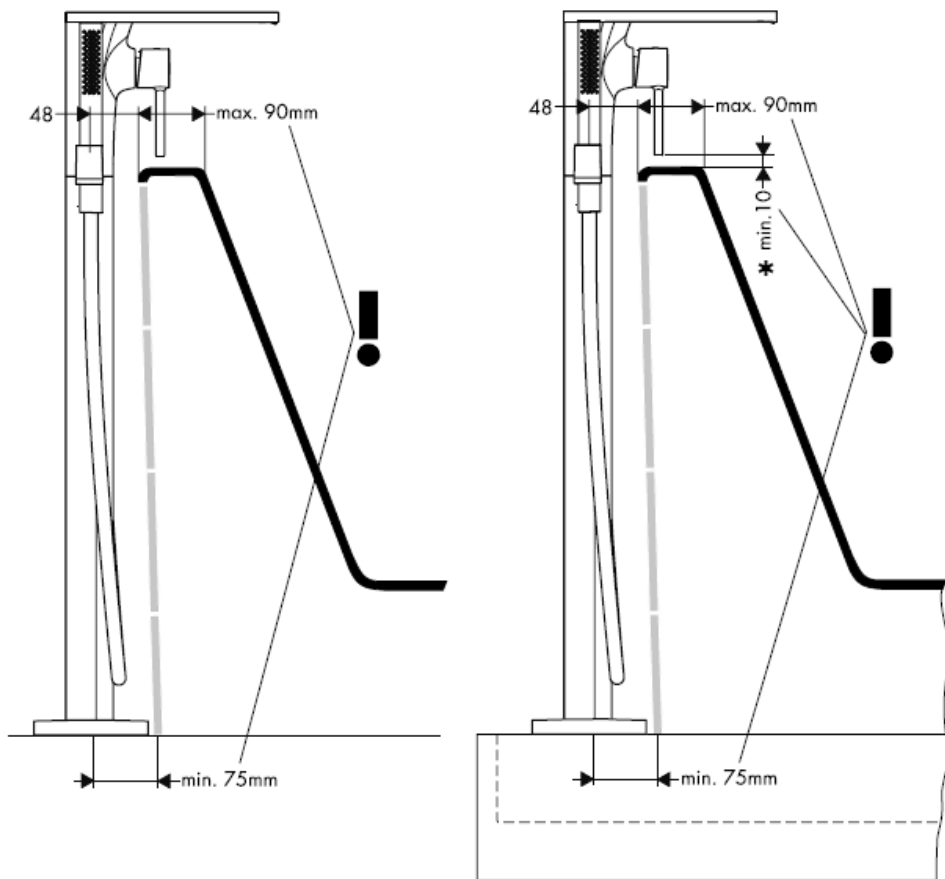

* < 10 min = Επιμήκυνση 60 mm (αρ. είδους 97686000)

Citterio 39451000

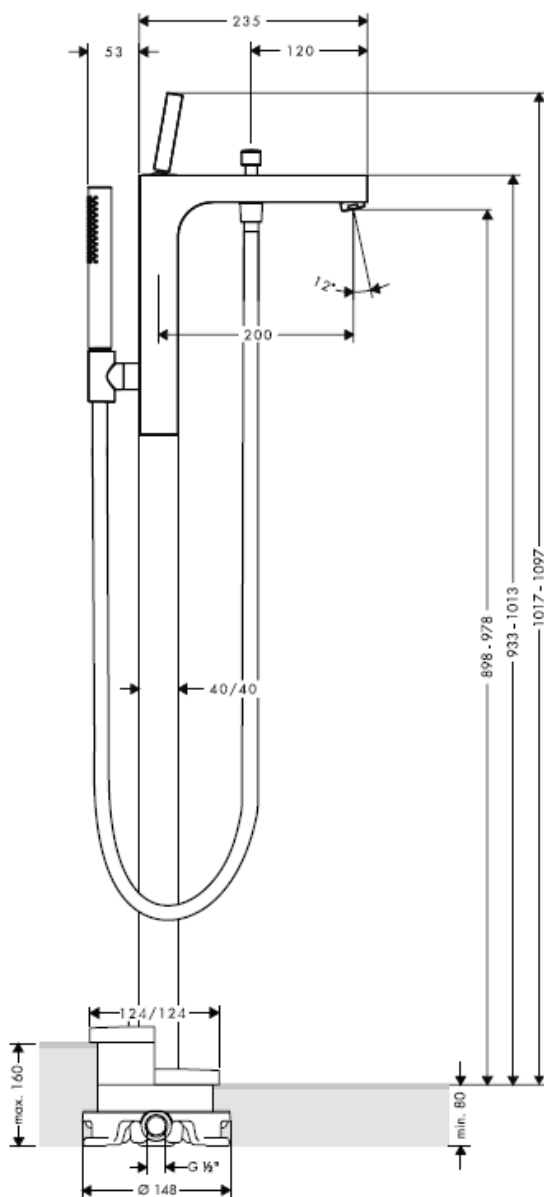

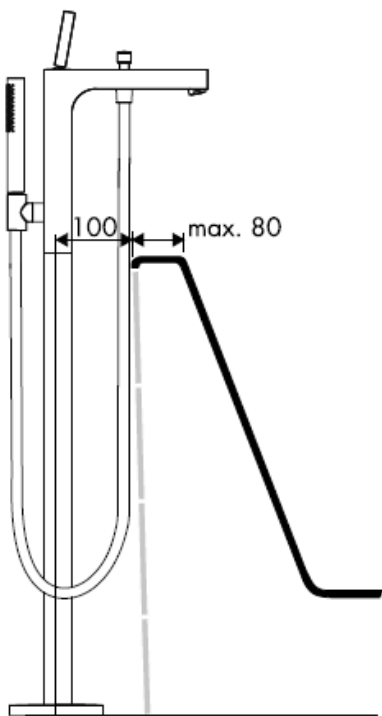

Προσοχή! Η κεντρική βάνα πρέπει να τοποθετηθεί, να πλυθεί και να ελεγχθεί με βάση τους ισχύοντες κανόνες υδραυλικής τέχνης!

Starck 10452180

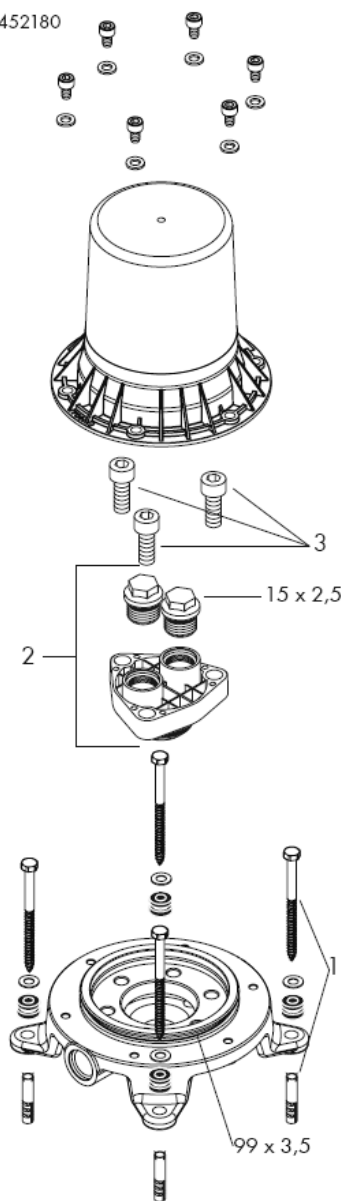

Montreux 16549180

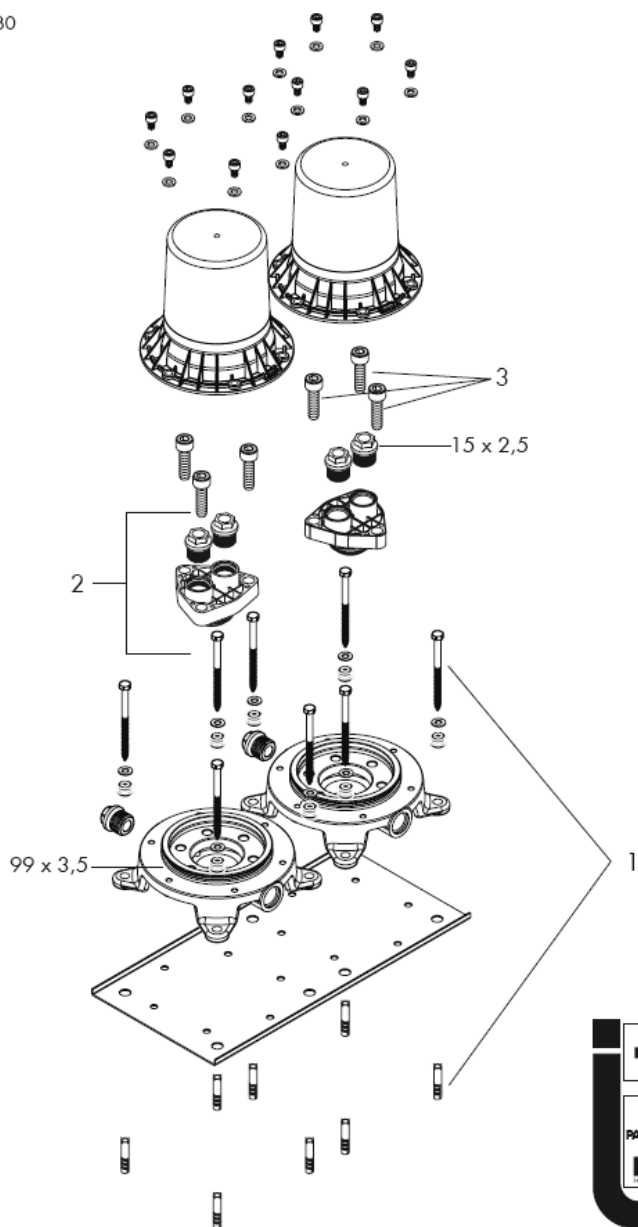

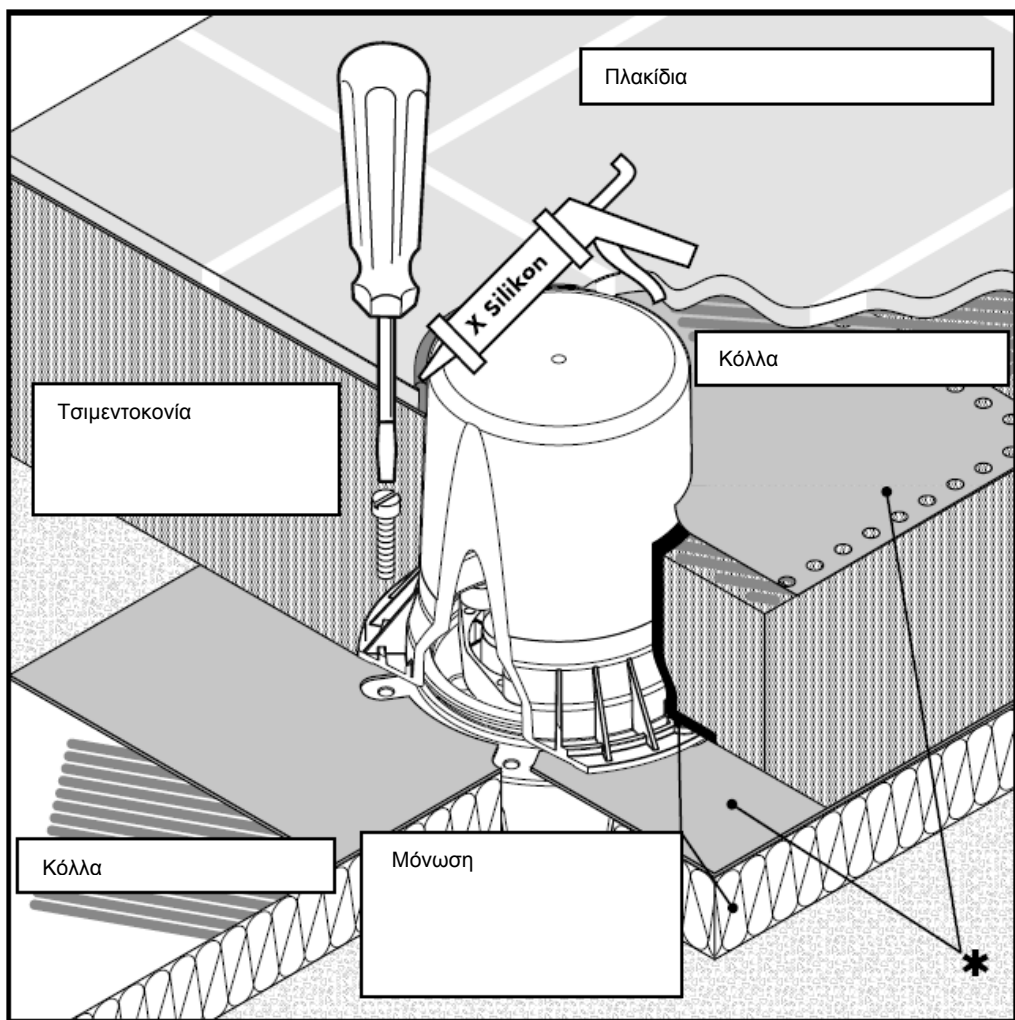

* προαιρετικό στεγανοποιητικό
 παράλειψη

X Σιλικόνη (δίχως οξικό οξύ!)

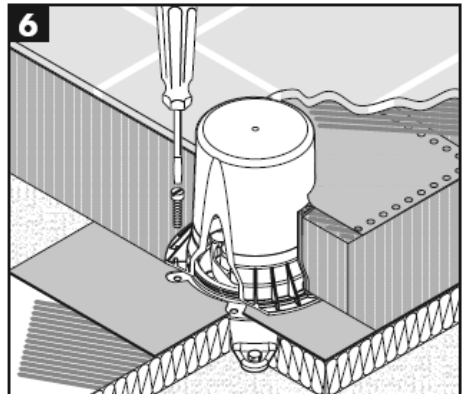
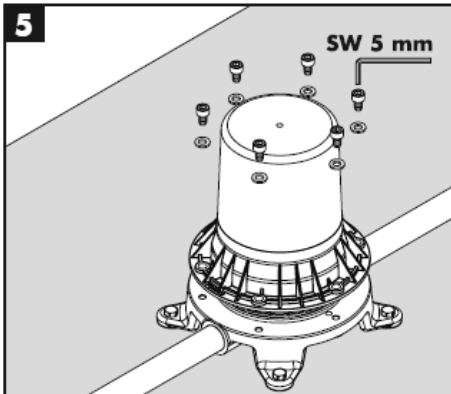
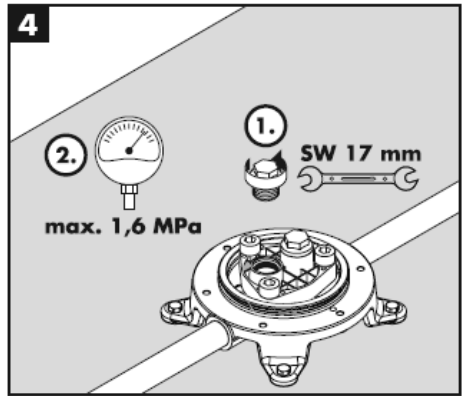
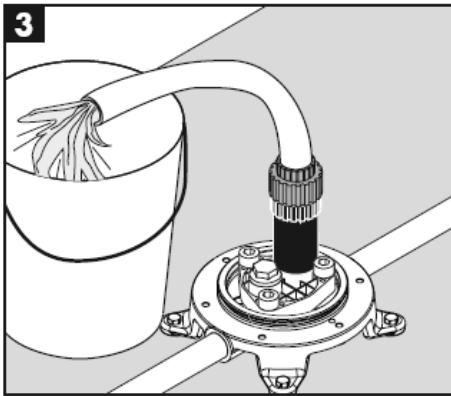
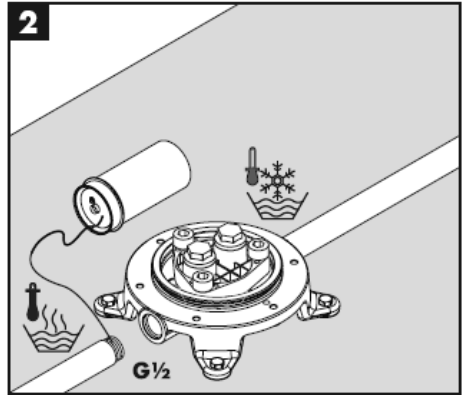
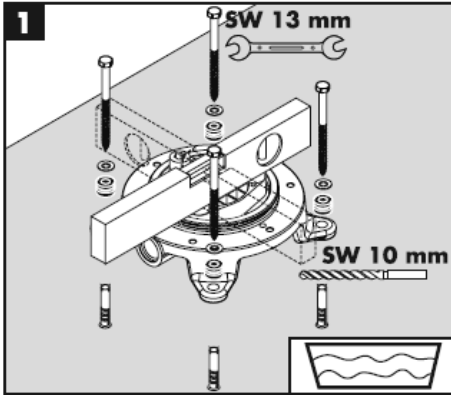

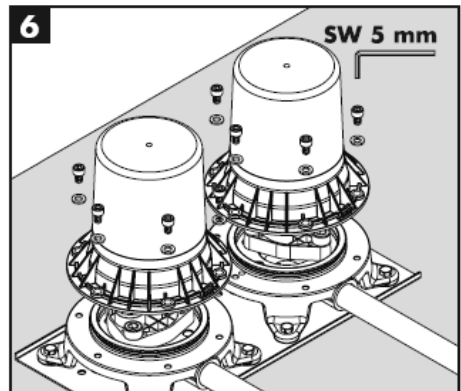
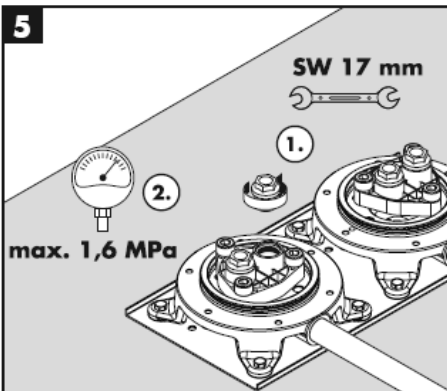
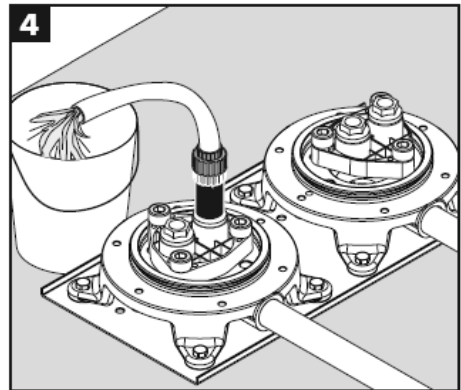
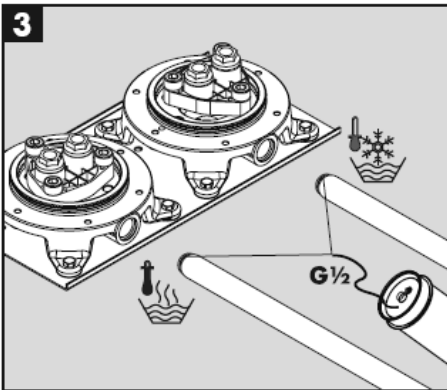
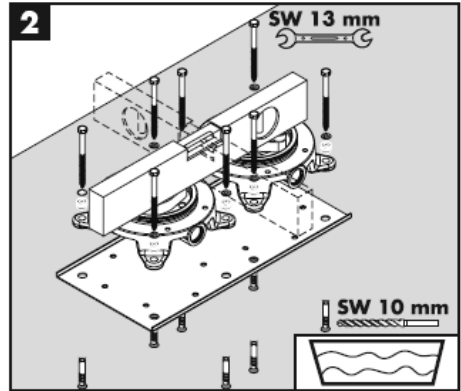
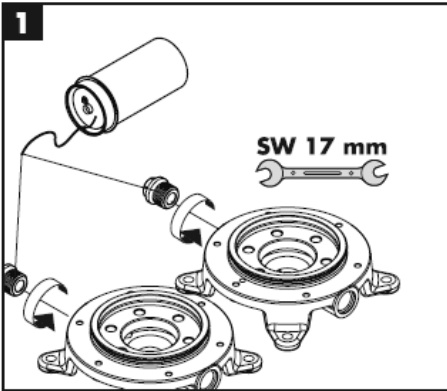

Συναρμολόγηση

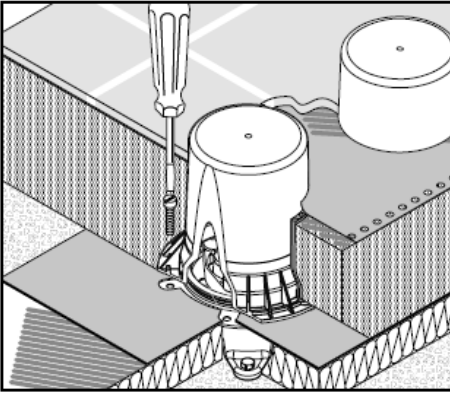

Ελληνικά

Τεχνικά Χαρακτηριστικά

Λειτουργία πίεσης: max. 1 MPa
Συνιστώμενη λειτουργία πίεσης: 0,1 – 0,5 MPa
Πίεση ελέγχου: 1,6 MPa
(1 MPa = 10 bar = 147 PSI)
Θερμοκρασία ζεστού νερού: max. 80° C
Συνιστώμενη θερμοκρασία ζεστού νερού: 65° C

Ανταλλακτικά βλ. Σελίδα 10 – 11

Ομάδα στηριγμάτων στερέωσης 96260000
Σετ παρεμβυσμάτων 96459000
Κυλινδρική βίδα M 10 x 35 97670000

Ειδικά αξεσουάρ

* Στεγανοποιητικό παρέμβυσμα 96441000
(δεν περιλαμβάνεται στον παραδοτέο εξοπλισμό)

Σήμα ελέγχου

	DVGW	P-IX	SVGW	ACS	NF	WRAS	KIWA
10452180				x		X	
16549180		PA-IX 18729/ICB					

hansgrohe

تعليمات التجميع

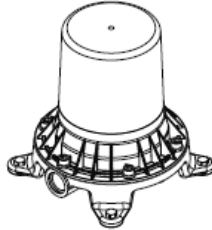

Starck
10452180

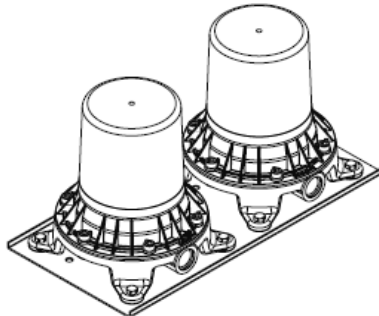

Montreux
16549180

AXOR[®]

hansgrohe

Starck 10458XXX

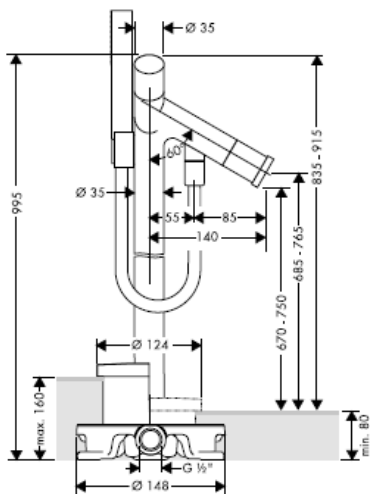

Starck 10060XXX

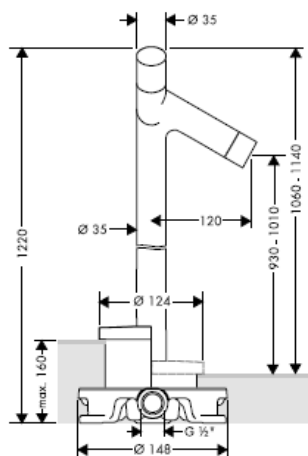

Starck 10456XXX

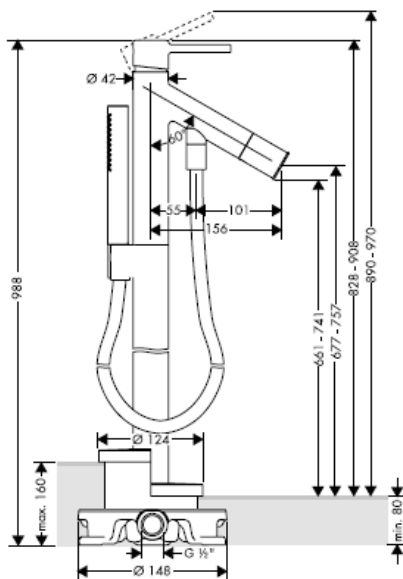

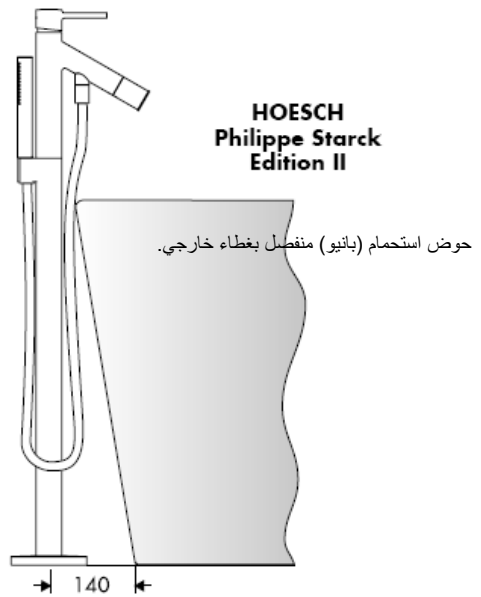
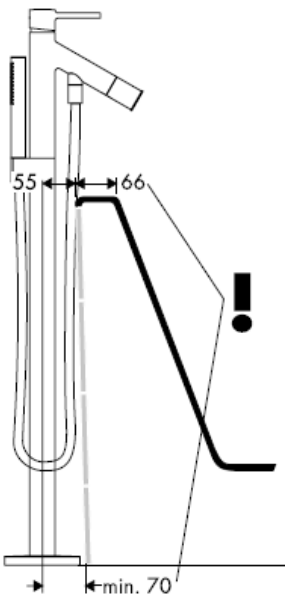
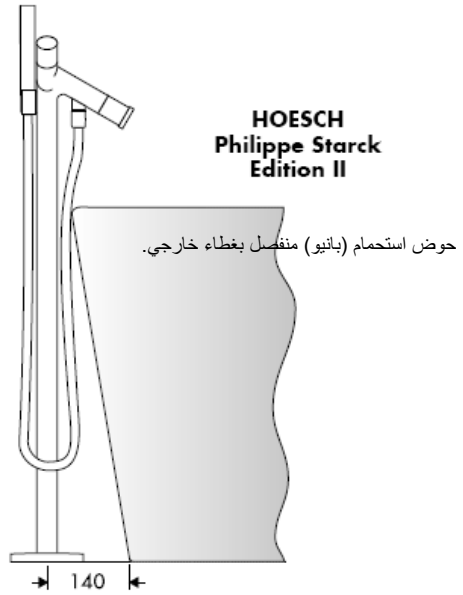
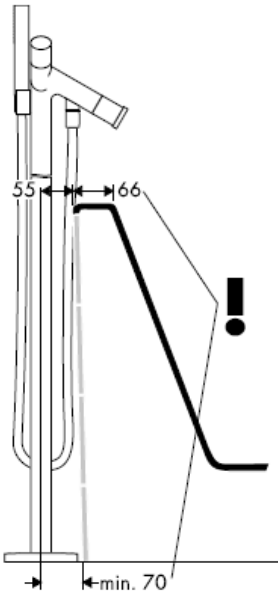

Starck X 10406000

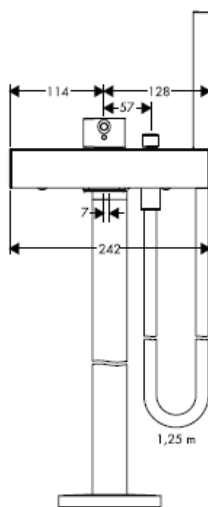
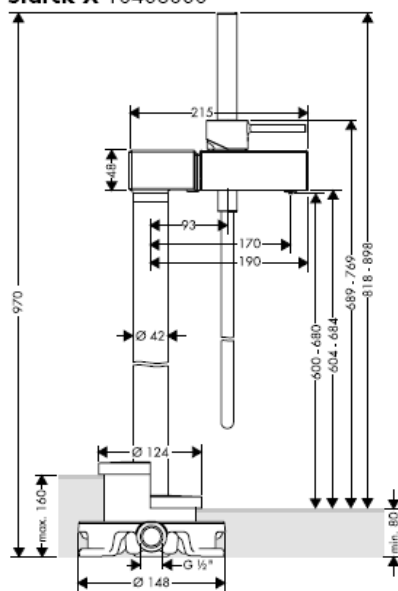

Montreux 16547XXX

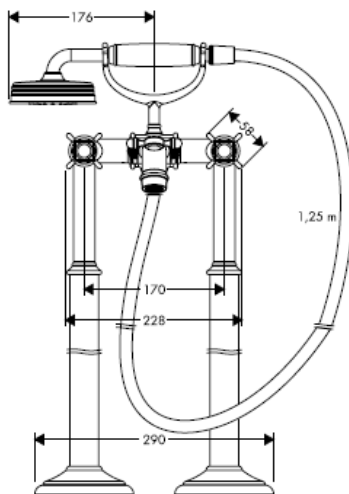
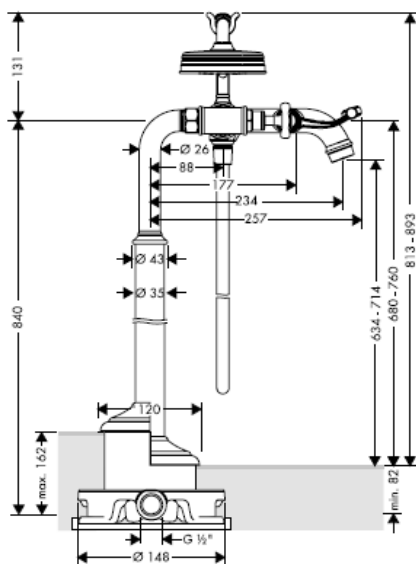

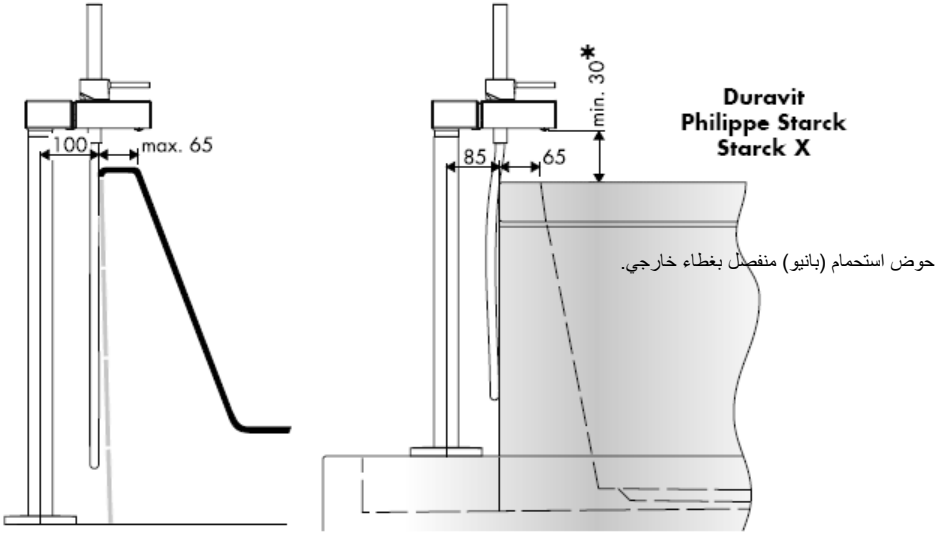

* < 30 min = وصلة إطالة 60 مم (رقم الصنف 97686000)

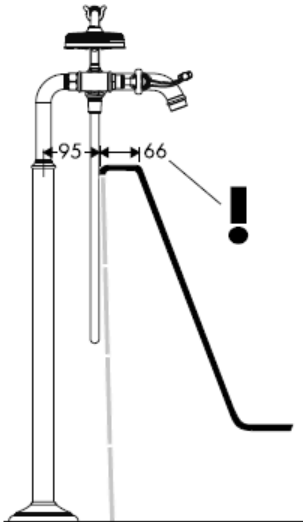

Massaud 18450000

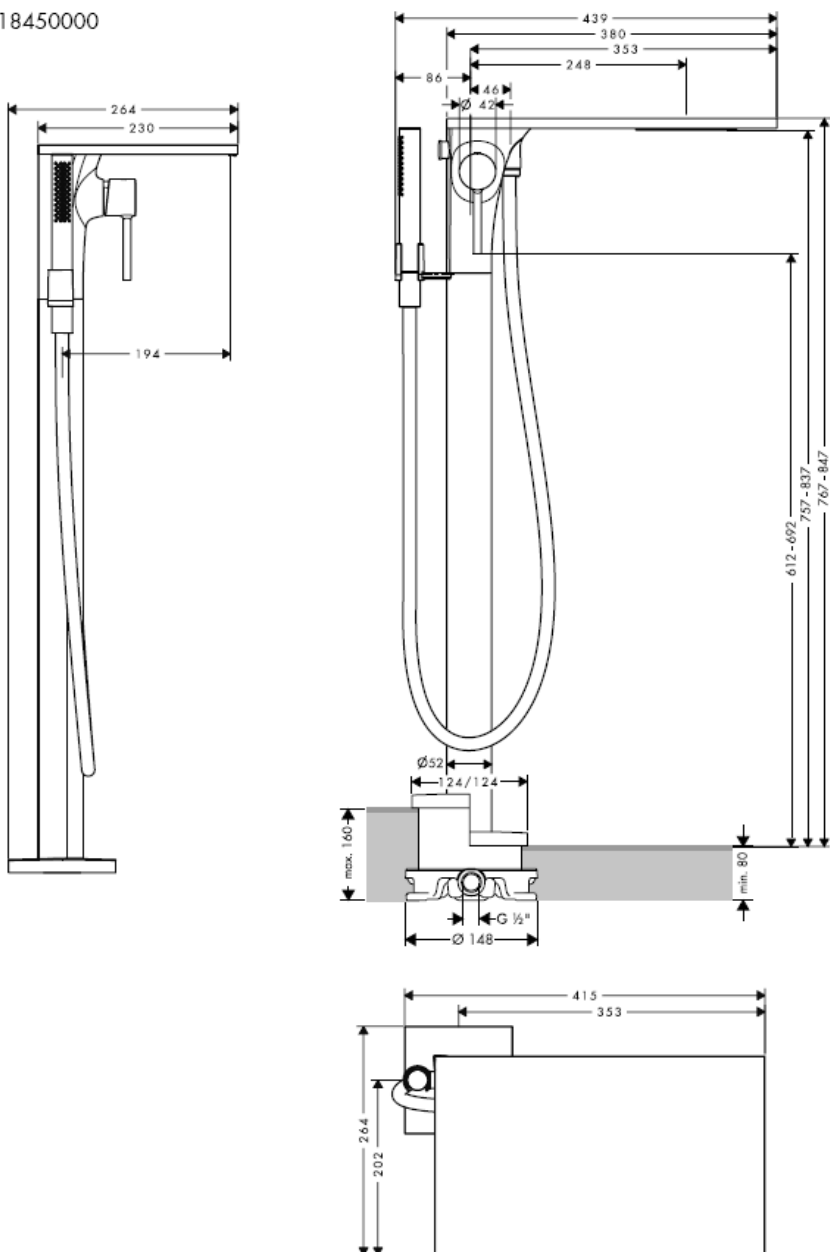

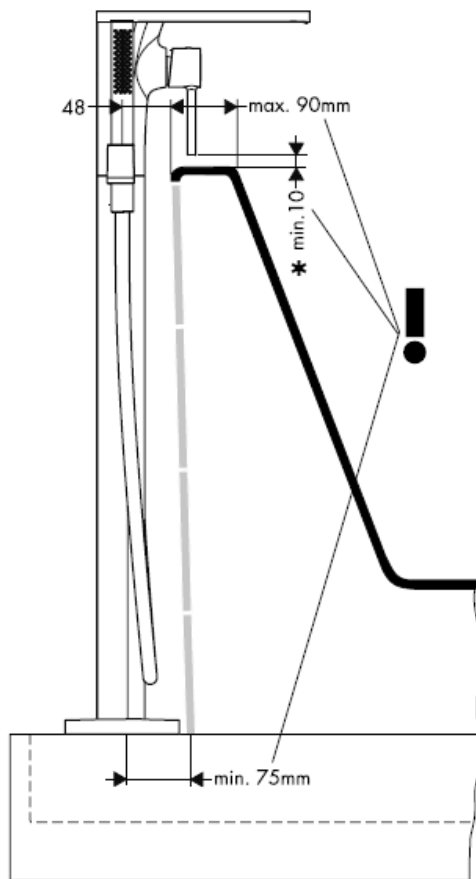
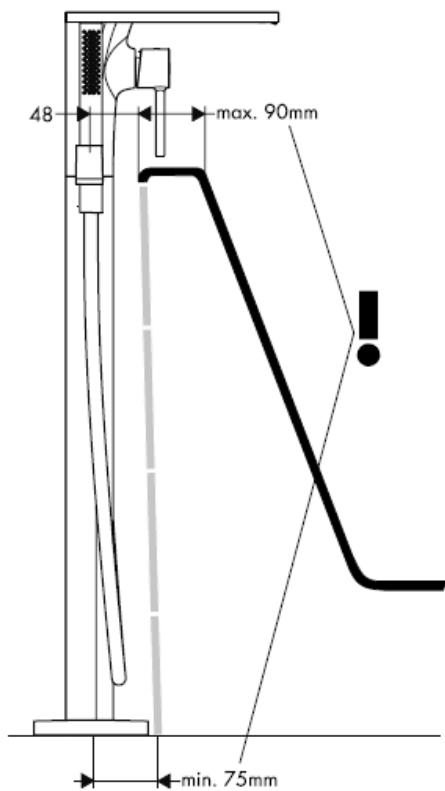

* < 10 min = وصلة إطالة 60 مم (رقم الصنف) 97686000

Citterio 39451000

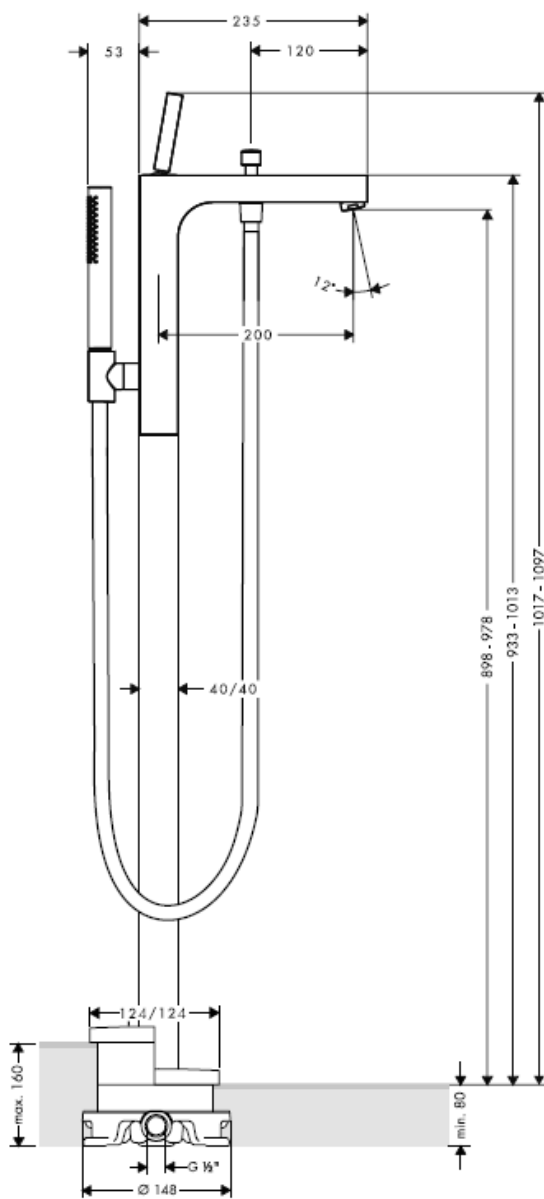

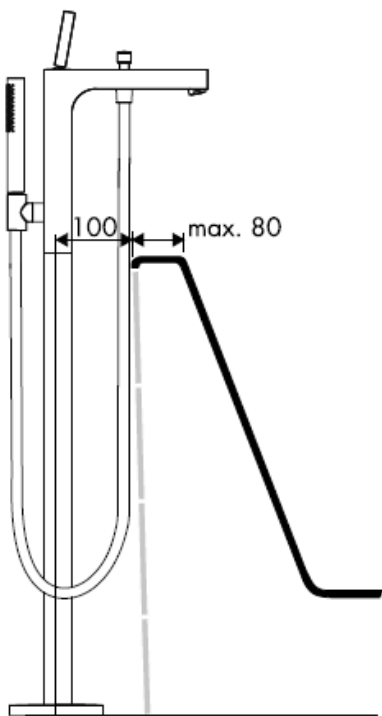

يجب تركيب الوصلة، وغمرها بالماء واختبارها وفقاً للمعايير تنبيه!
الساوية!

Starck 10452180

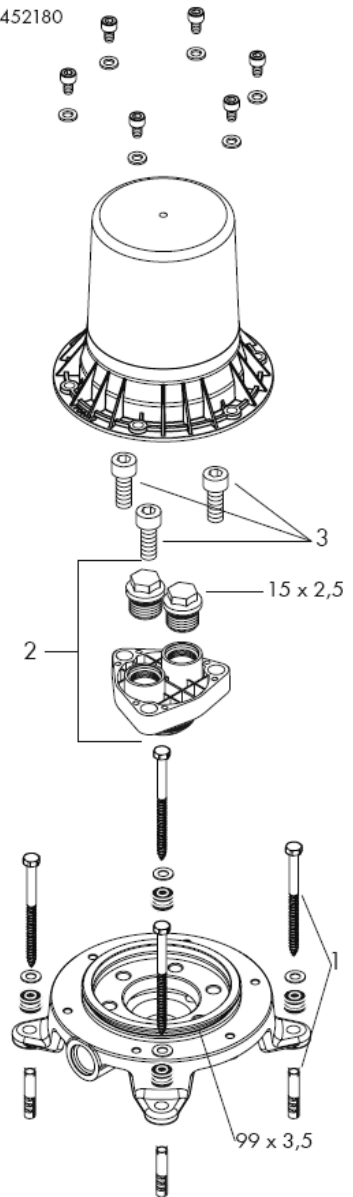

Montreux 16549180

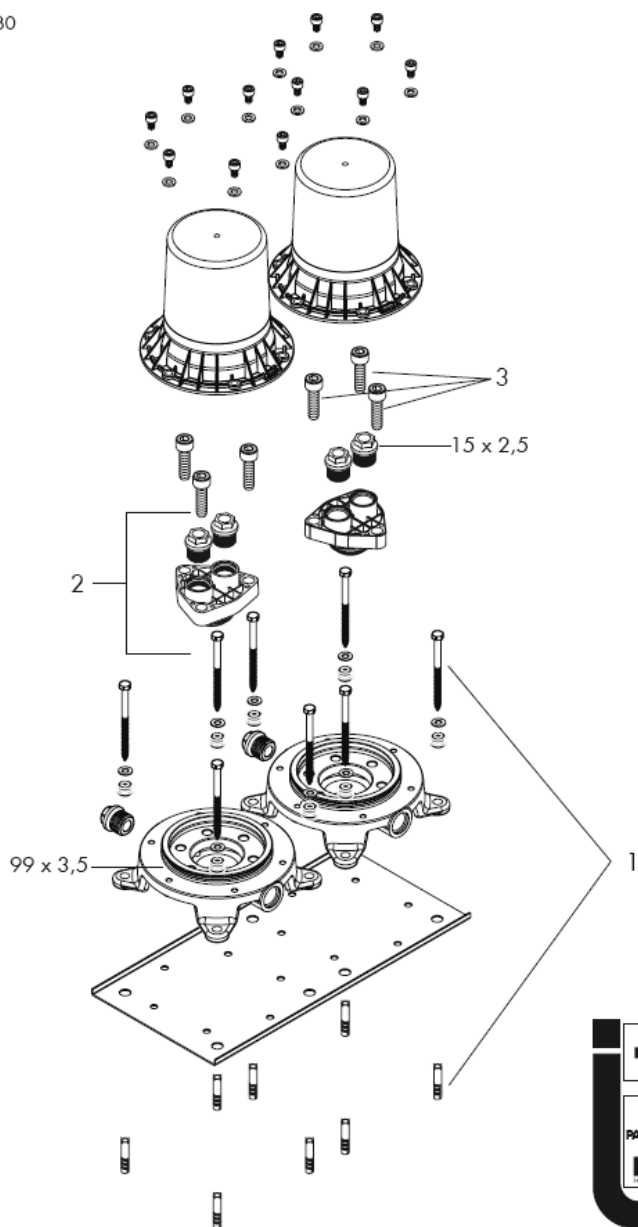

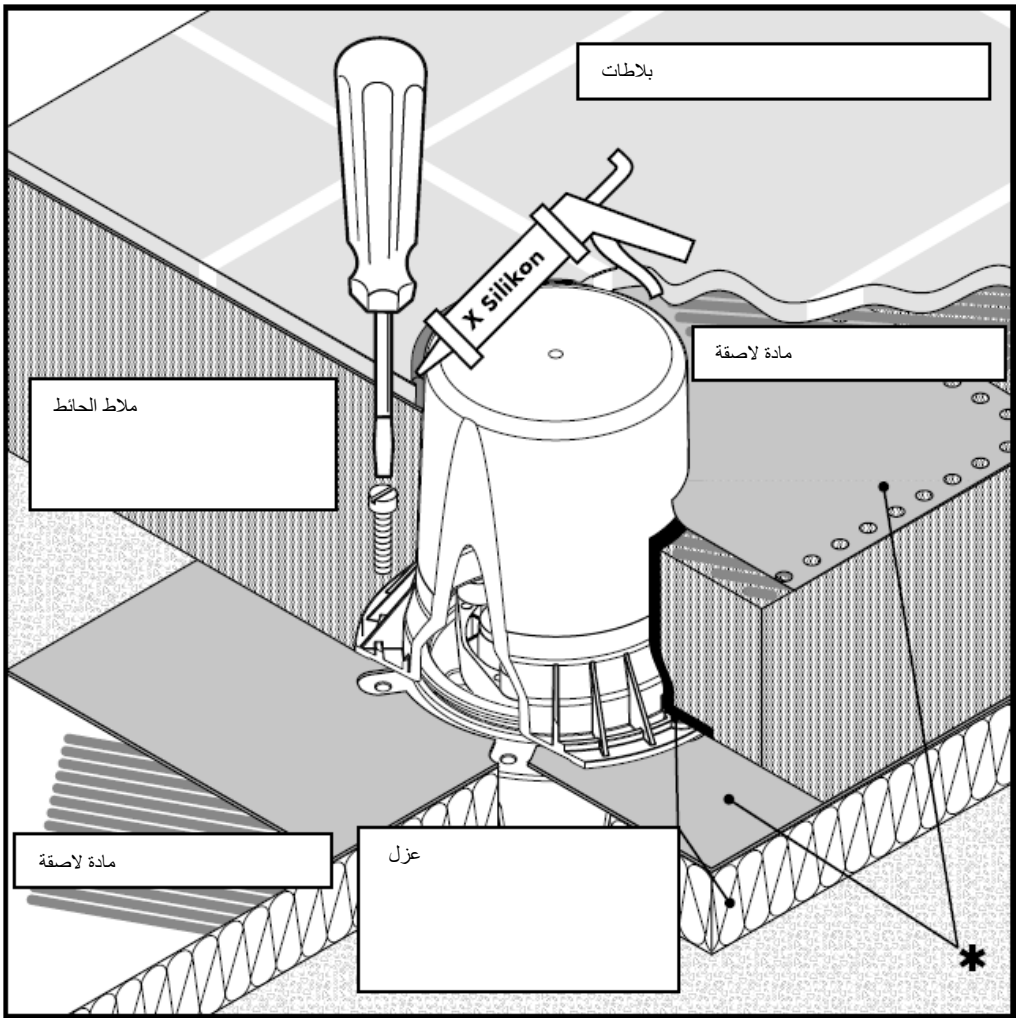

* إذا لزم الأمر، يرجى طلب رقيقة معدنية مانعة للتسرب
 ١ ٢ ٣ ٤ ٥ ٦ ٧ ٨ ٩ ١٠ ١١ ١٢ ١٣ ١٤ ١٥ ١٦ ١٧ ١٨ ١٩ ٢٠ ٢١ ٢٢ ٢٣ ٢٤ ٢٥ ٢٦ ٢٧ ٢٨ ٢٩ ٣٠ ٣١ ٣٢ ٣٣ ٣٤ ٣٥ ٣٦ ٣٧ ٣٨ ٣٩ ٤٠ ٤١ ٤٢ ٤٣ ٤٤ ٤٥ ٤٦ ٤٧ ٤٨ ٤٩ ٥٠ ٥١ ٥٢ ٥٣ ٥٤ ٥٥ ٥٦ ٥٧ ٥٨ ٥٩ ٦٠ ٦١ ٦٢ ٦٣ ٦٤ ٦٥ ٦٦ ٦٧ ٦٨ ٦٩ ٧٠ ٧١ ٧٢ ٧٣ ٧٤ ٧٥ ٧٦ ٧٧ ٧٨ ٧٩ ٨٠ ٨١ ٨٢ ٨٣ ٨٤ ٨٥ ٨٦ ٨٧ ٨٨ ٨٩ ٩٠ ٩١ ٩٢ ٩٣ ٩٤ ٩٥ ٩٦ ٩٧ ٩٨ ٩٩ ١٠٠

سيليكون (خالي من حمض الخليك!) X

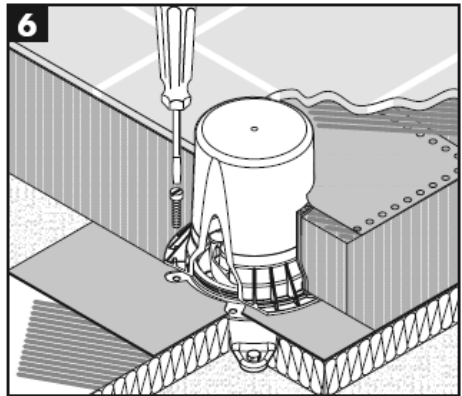
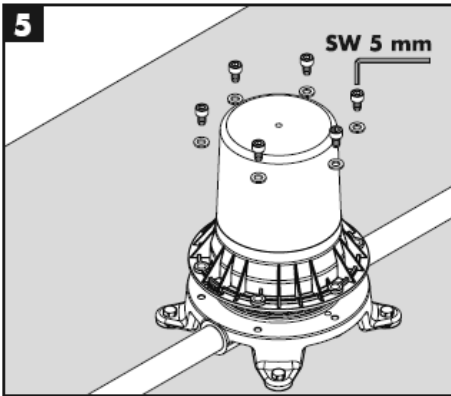
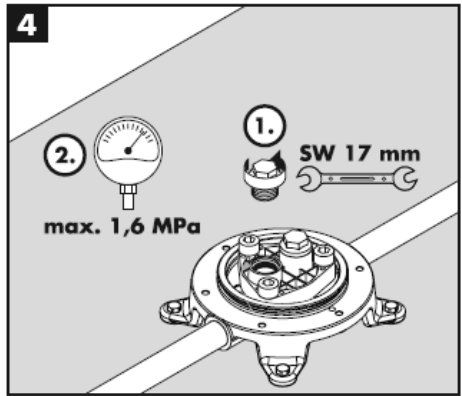
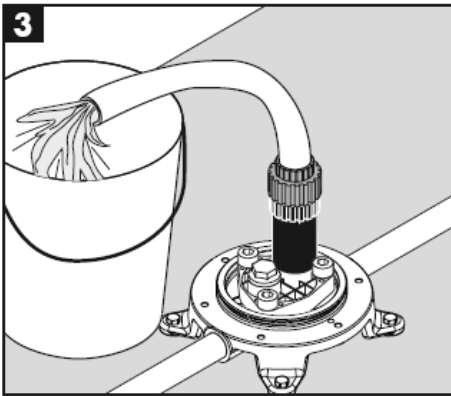
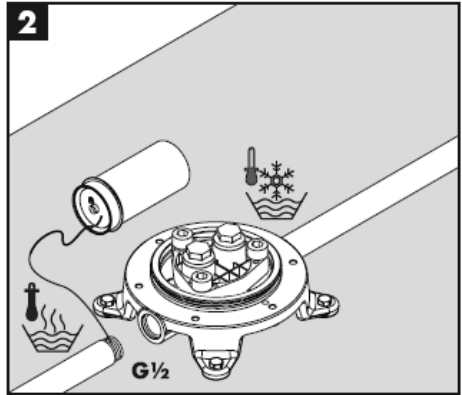
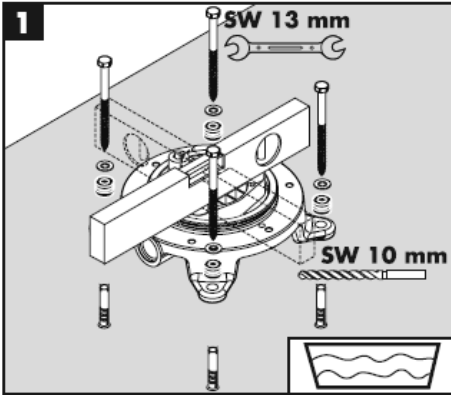

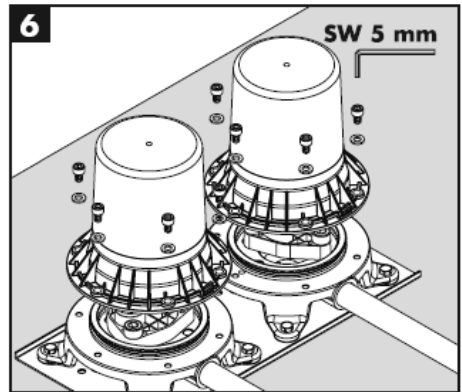
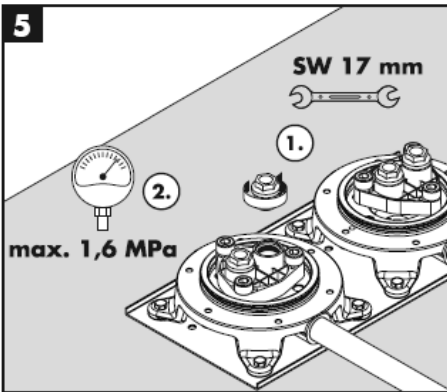
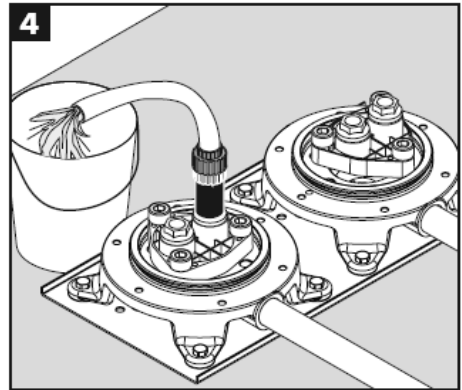
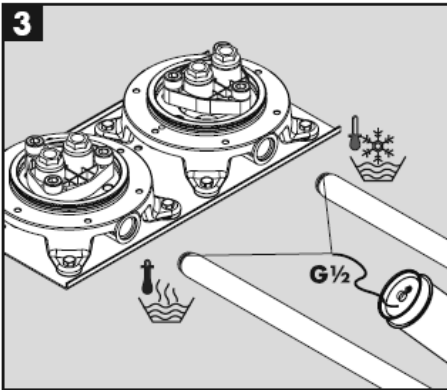
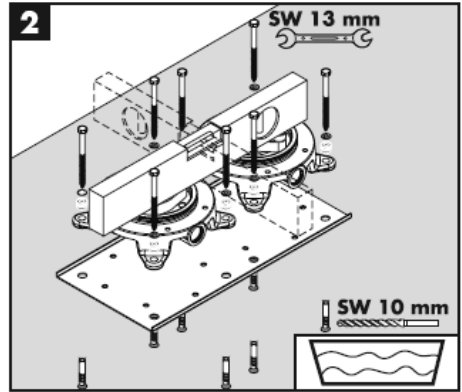
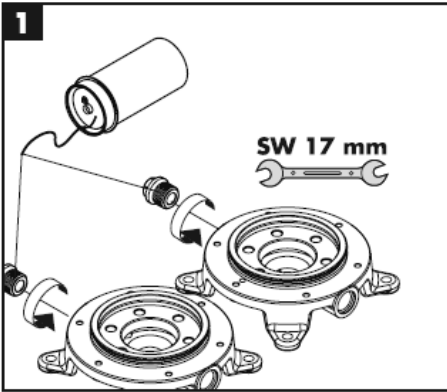

التركيب

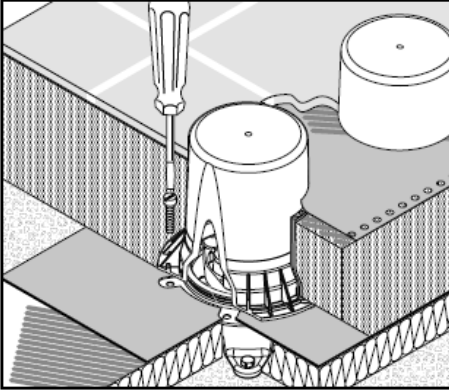

عربي

المواصفات الفنية

ضغط التشغيل:	max. 1 MPa
ضغط التشغيل الموصى به:	0,1 – 0,5 MPa
ضغط الاختبار:	1,6 MPa
1)MPa = 147 PSI (10 بار =	
درجة حرارة الساخن:	max. 80° C
درجة الحرارة الموصى بها للماء الساخن:	65° C

10 – 11 راجع صفحة قطع الغيار

مجموعة التثبيت	96260000
طقم منع التسرب	96459000
مسمار الفتحة المسدسة M 10 x 35	97670000
ملحقات خاصة	
رقاقة إغلاق* (غير مدرج مع المحتويات المسلمة)	96441000

شهادة اختبار

	DVGW	P-IX	SVGW	ACS	NF	WRAS	KIWA
10452180				x		X	
16549180		PA-IX 18729/ICB					

hansgrohe

Navodila za montažo

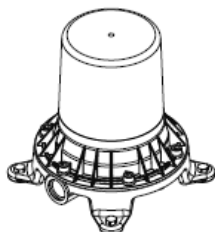

Starck
10452180

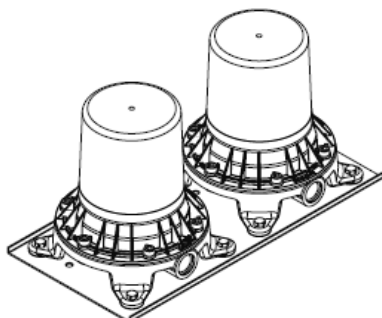

Montreux
16549180

AXOR[®]

hansgrohe

Starck 10458XXX

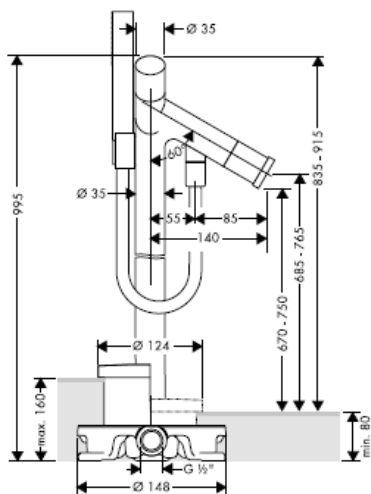

Starck 10060XXX

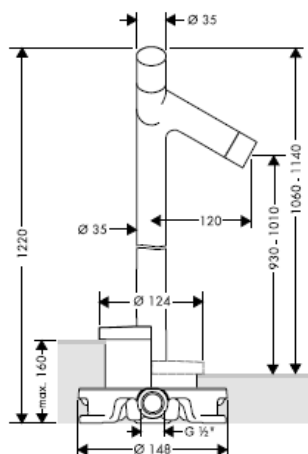

Starck 10456XXX

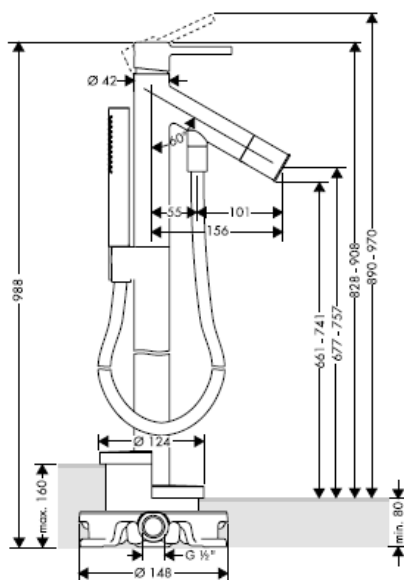

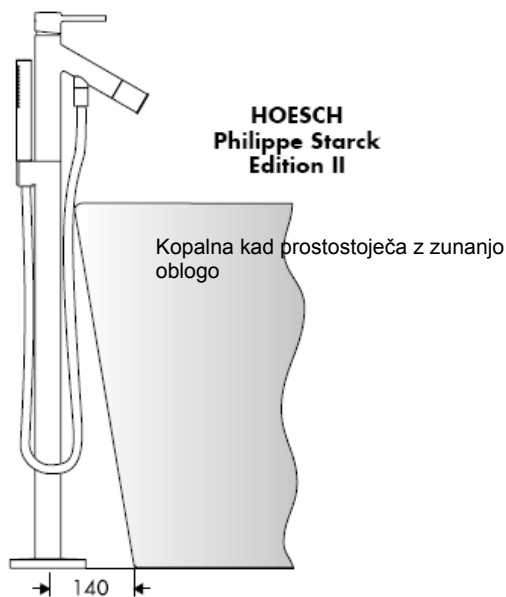
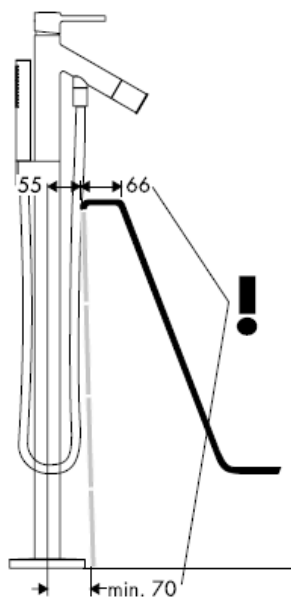
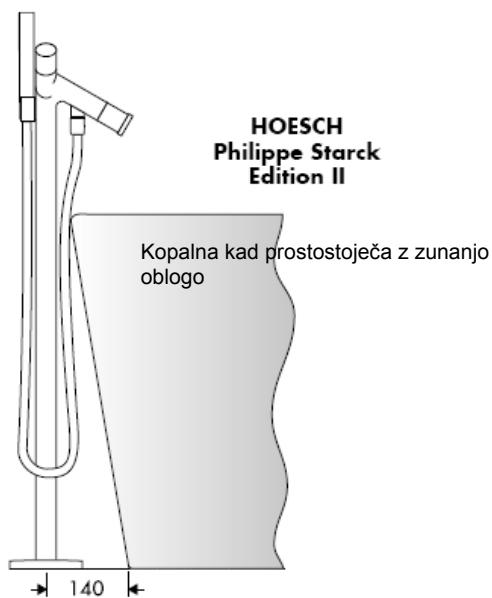

Starck X 10406000

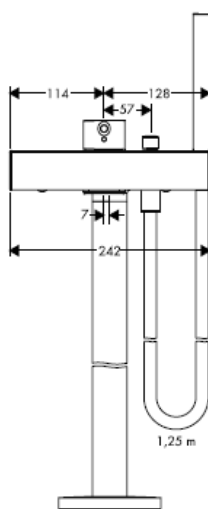
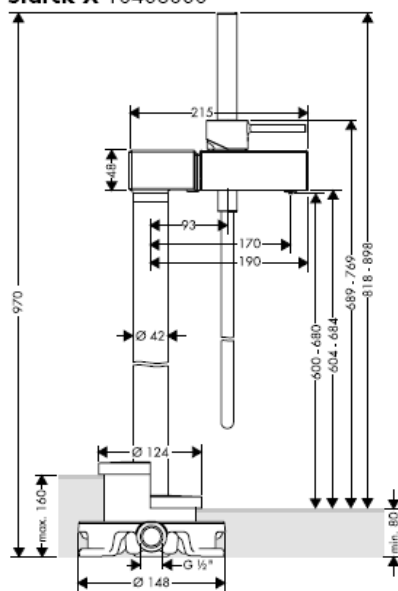

Montreux 16547XXX

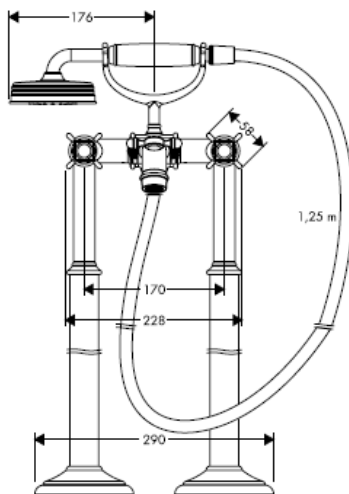
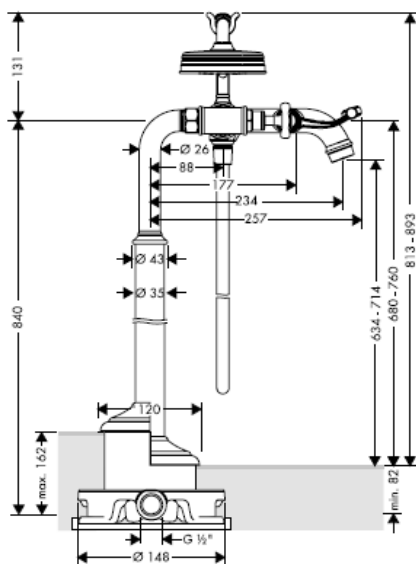

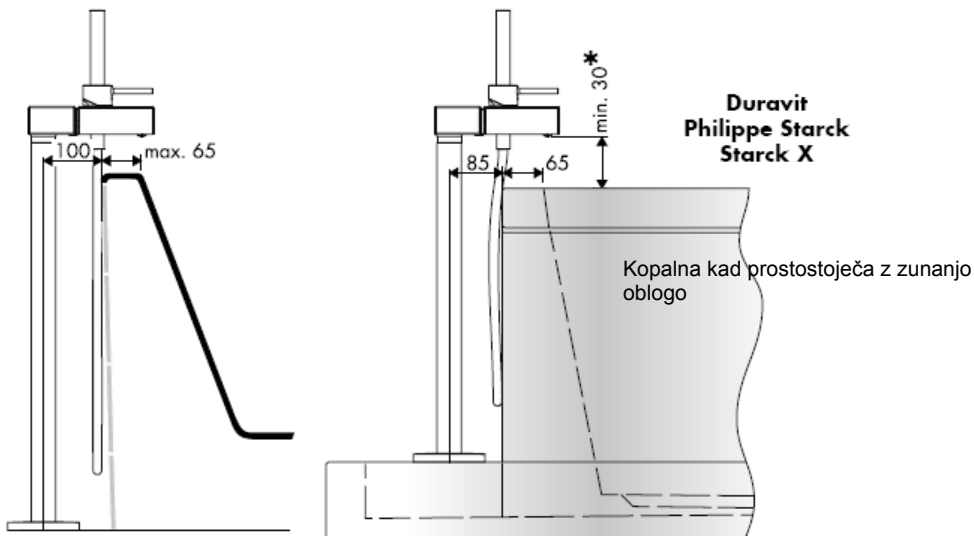

* < 30 min = jeu de rallonge 60 mm (številka artikla 97686000)



Massaud 18450000

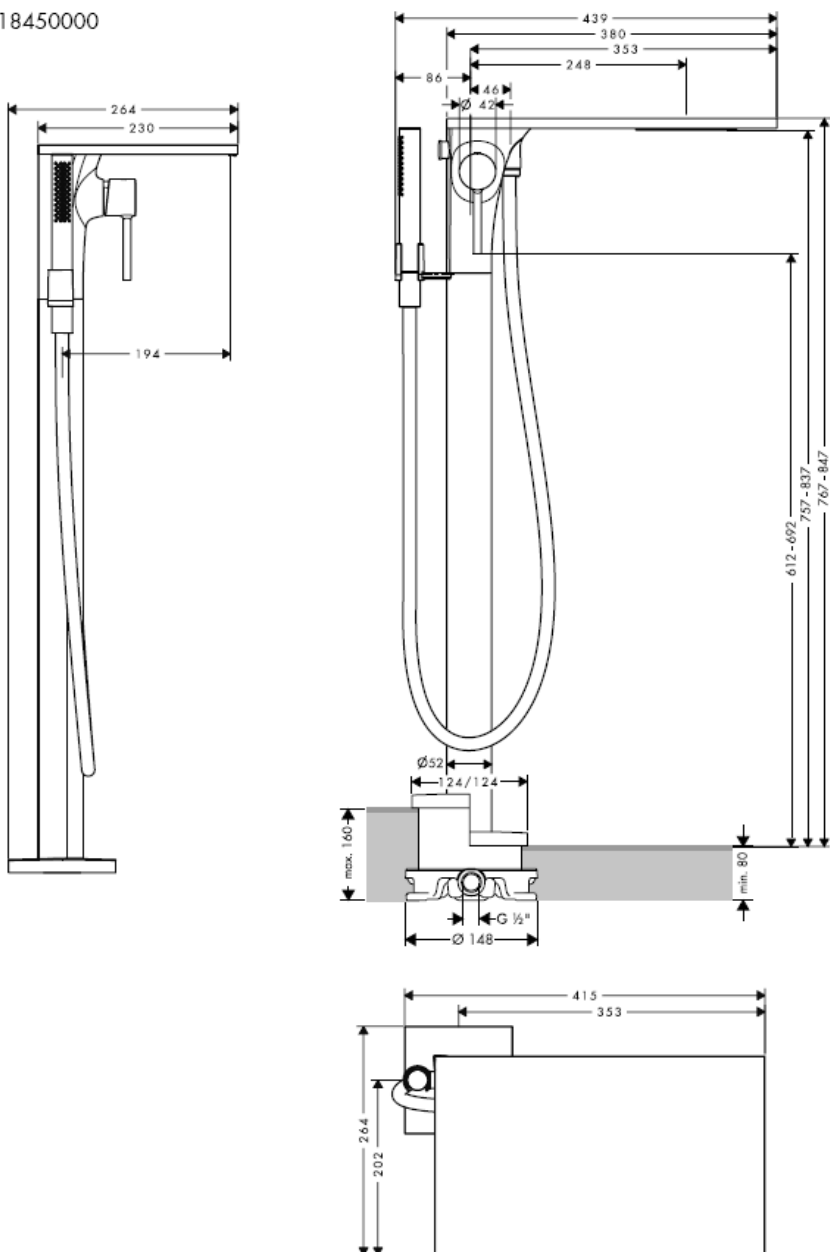

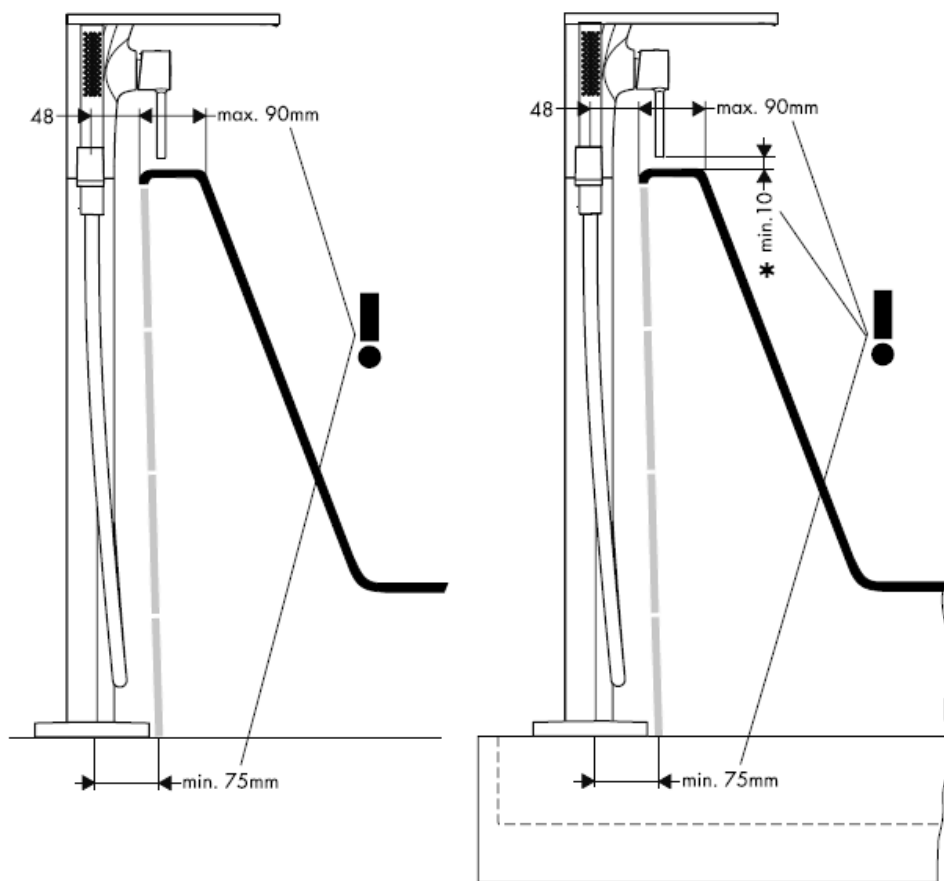

* < 10 min = Podaljšek 60 mm (številka artikla 97686000)

Citterio 39451000

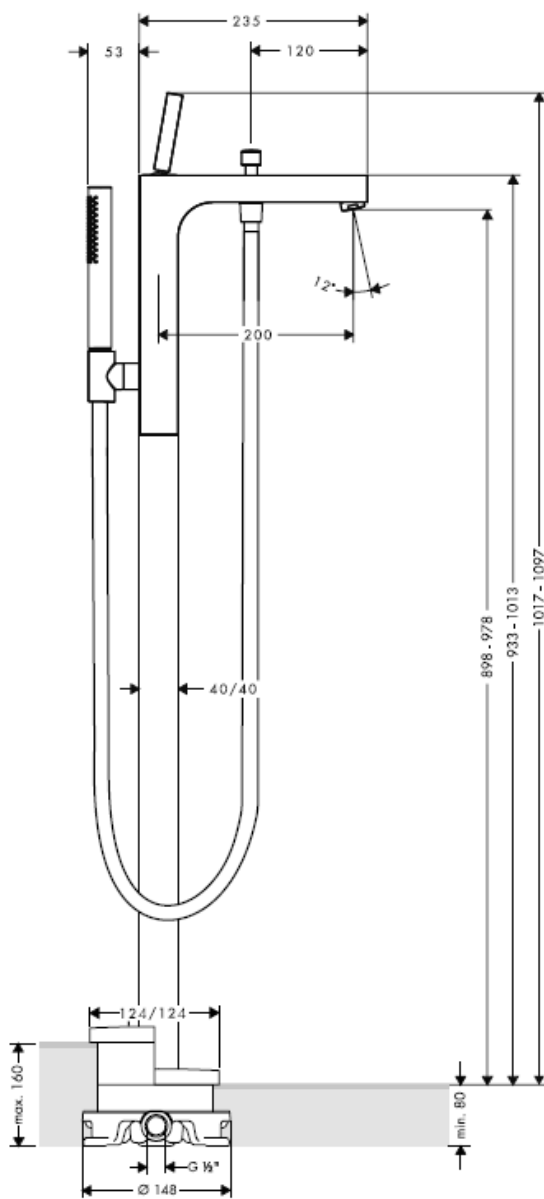

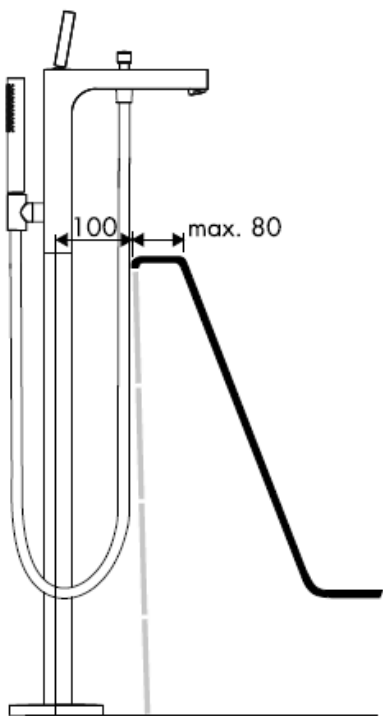

Pozor! Armaturo je potrebno montirati, sprati in testirati v skladu z veljavnimi normami!

Starck 10452180

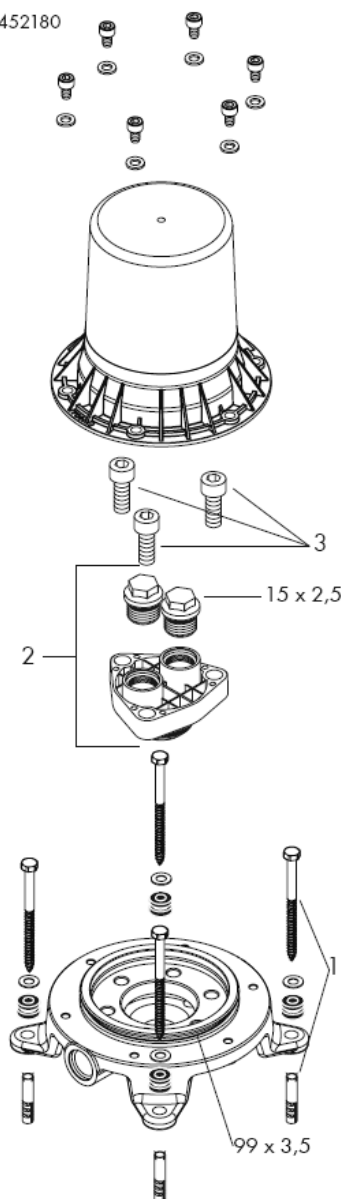

Montreux 16549180

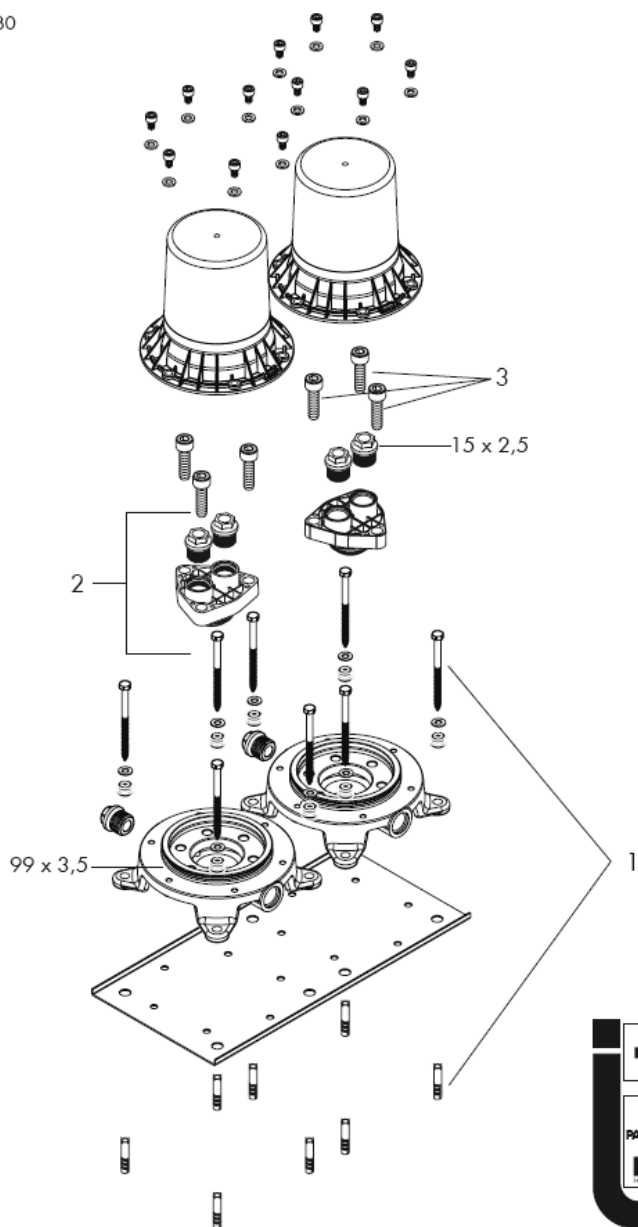

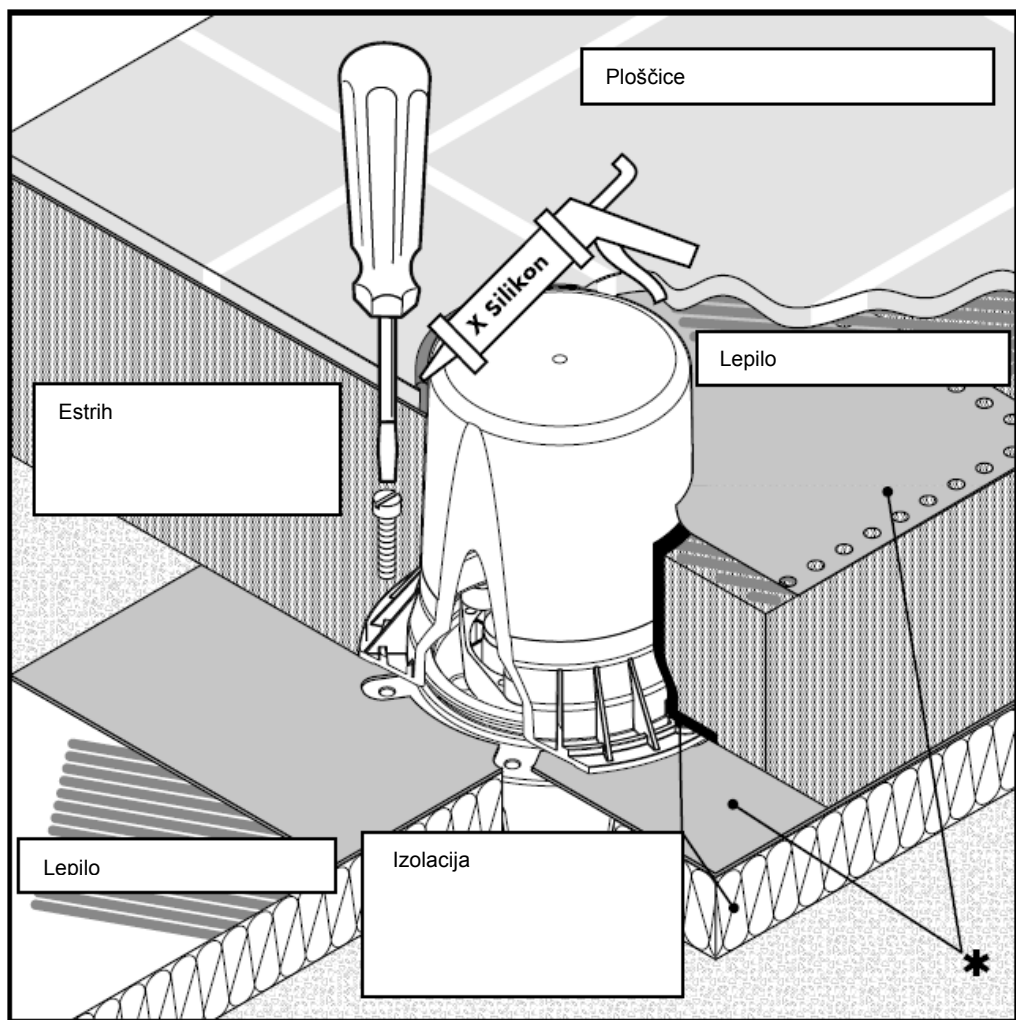

* Tesnilna manšeta je dobavljiva posebej.

X Silikon (brez očetne kisline)

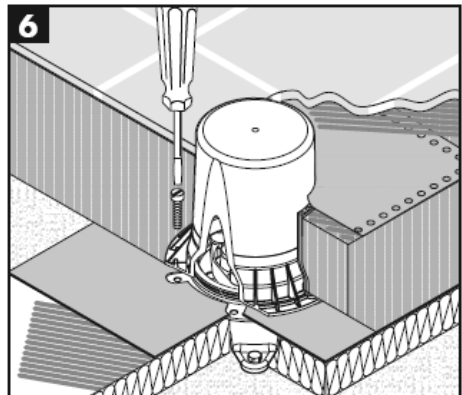
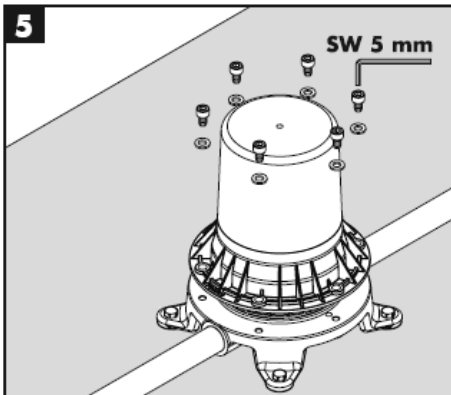
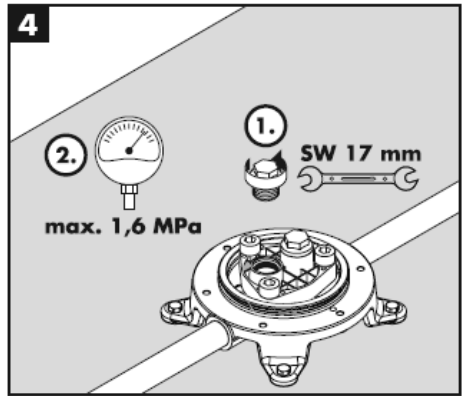
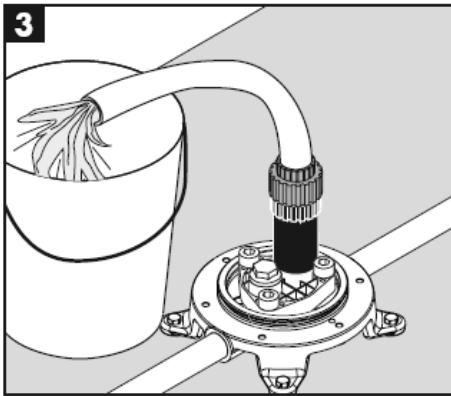
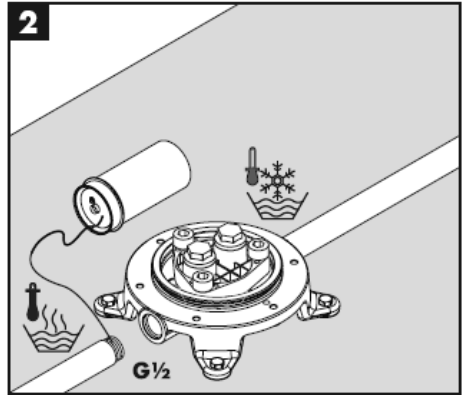
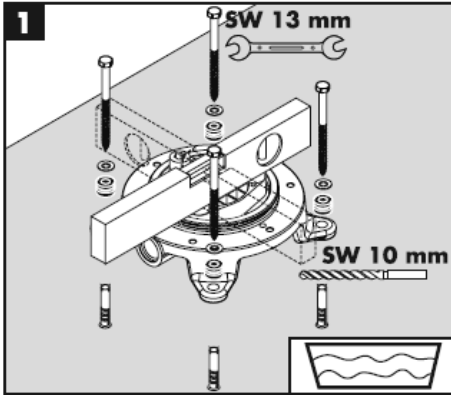

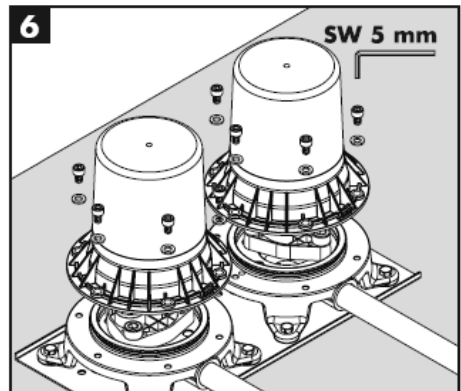
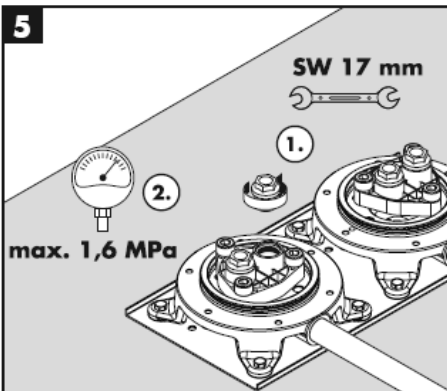
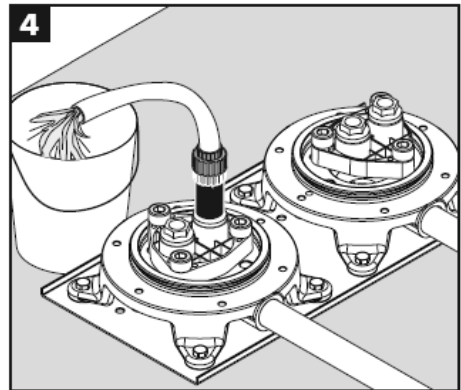
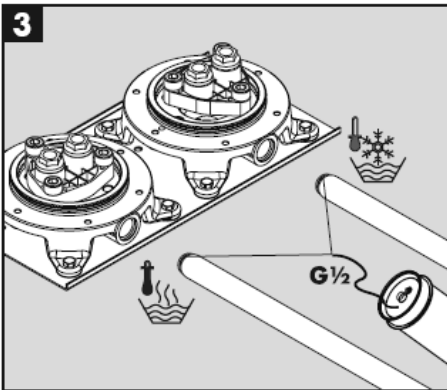
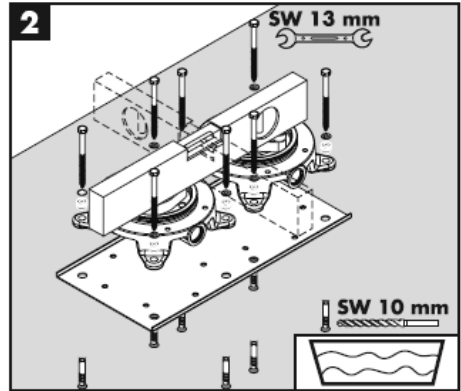
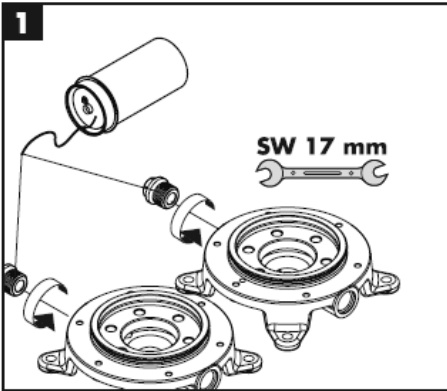

Montaža

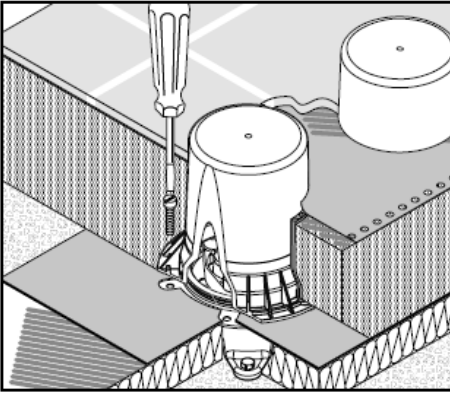

Slovenski

Tehnični podatki

Delovni tlak:	max. 1 MPa
Priporočeni delovni tlak:	0,1 – 0,5 MPa
Preskusni tlak:	1,6 MPa
(1 MPa = 10 bar = 147 PSI)	
Temperatura tople vode:	max. 80° C
Priporočena temperatura tople vode:	65° C

Rezervni deli glejte stran 10 – 11

Pritrditveni komplet	96260000
Komplet tesnil	96459000
Cilindrični vijak M 10 x 35	97670000

Poseben pribor

* Tesnilna manšeta (Ni vključeno)	96441000
--------------------------------------	----------

Preskusni znak

	DVGW	P-IX	SVGW	ACS	NF	WRAS	KIWA
10452180				x		X	
16549180		PA-IX 18729/ICB					

hansgrohe

Paigaldusjuhend

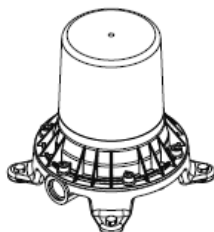

Starck
10452180

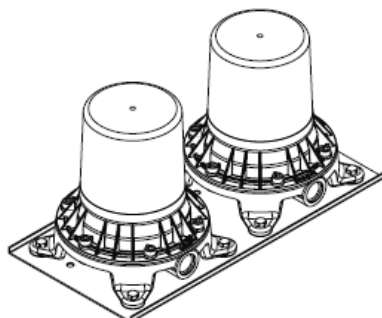

Montreux
16549180

AXOR[®]

hansgrohe

Starck 10458XXX

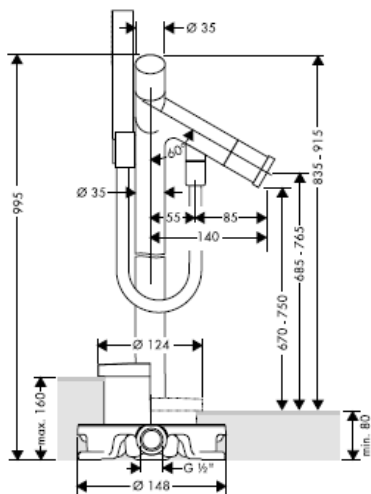

Starck 10060XXX

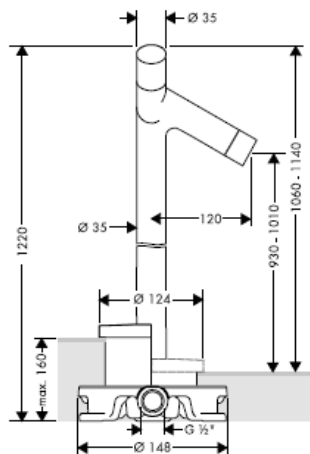

Starck 10456XXX

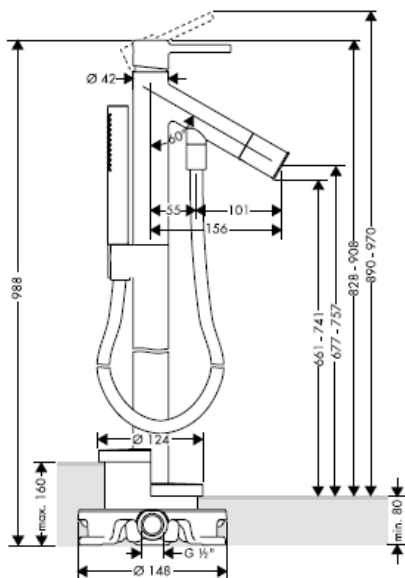

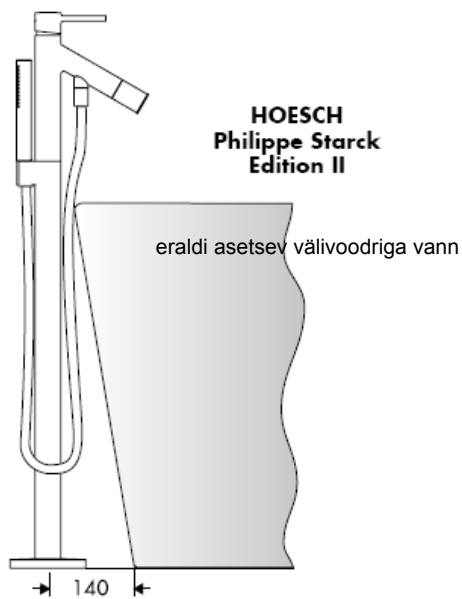
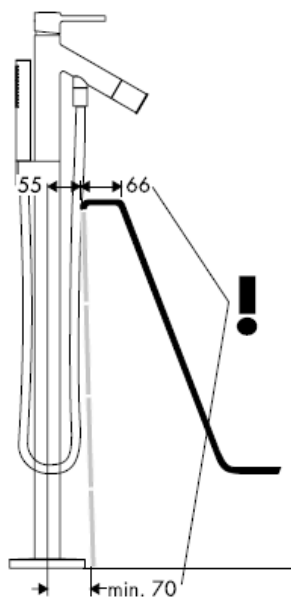
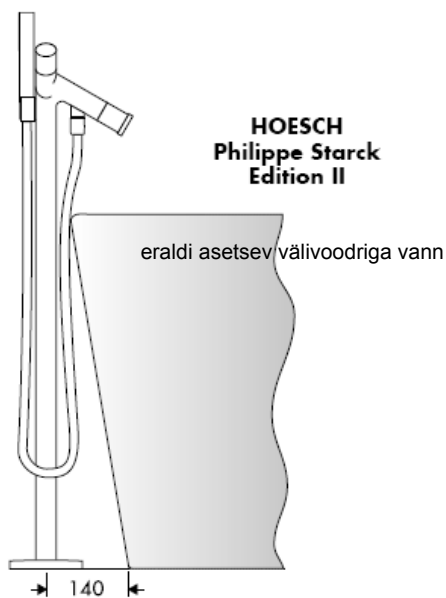

Starck X 10406000

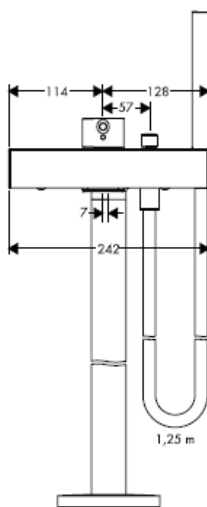
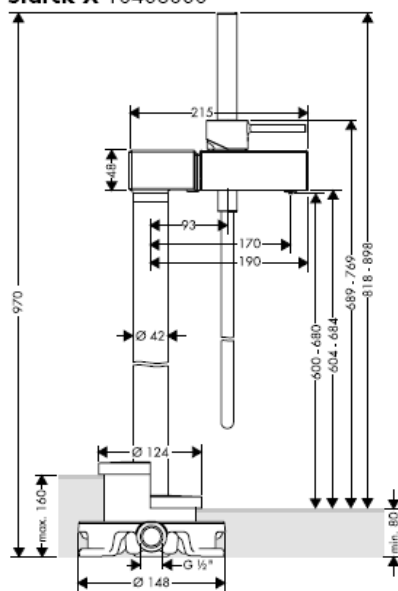

Montreux 16547XXX

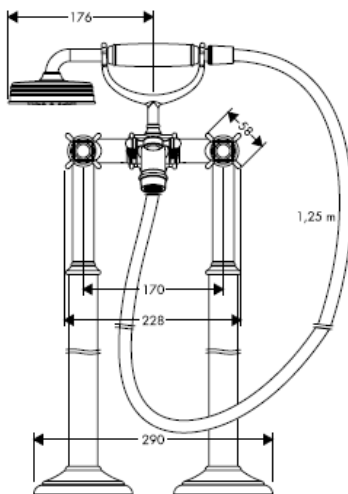
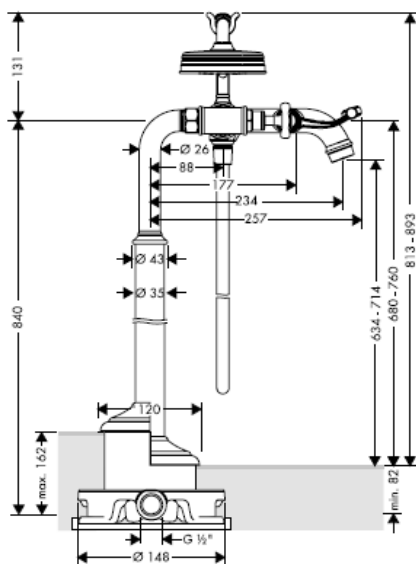

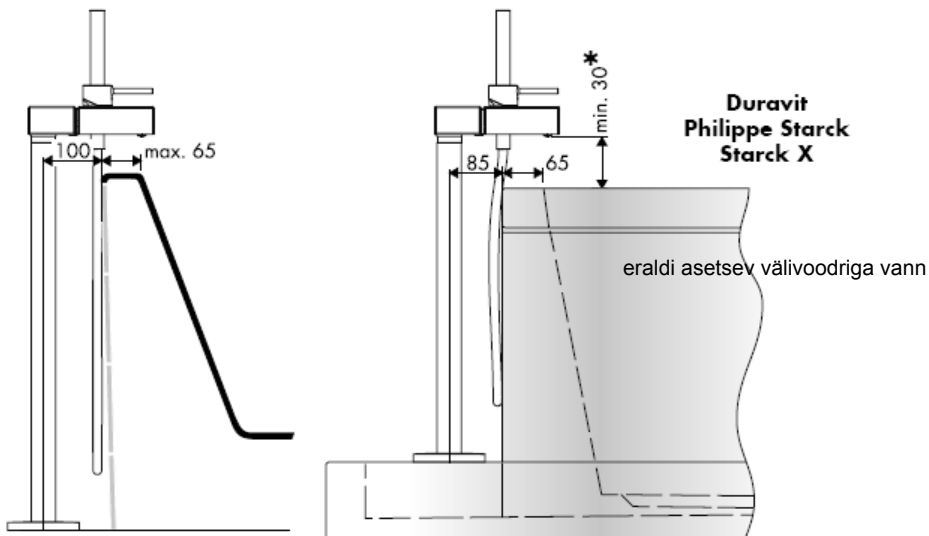

* < 30 min = pikendus 60 mm (artikli number 97686000)



Massaud 18450000

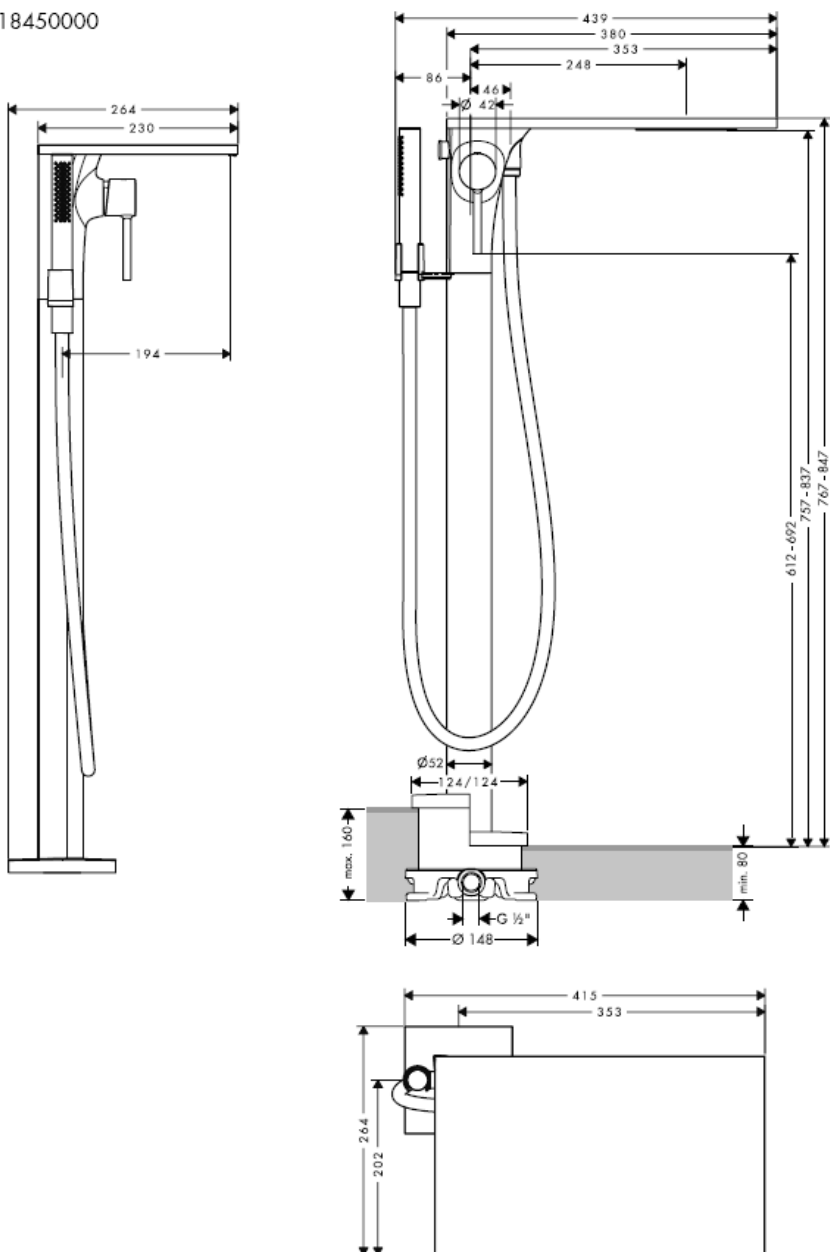

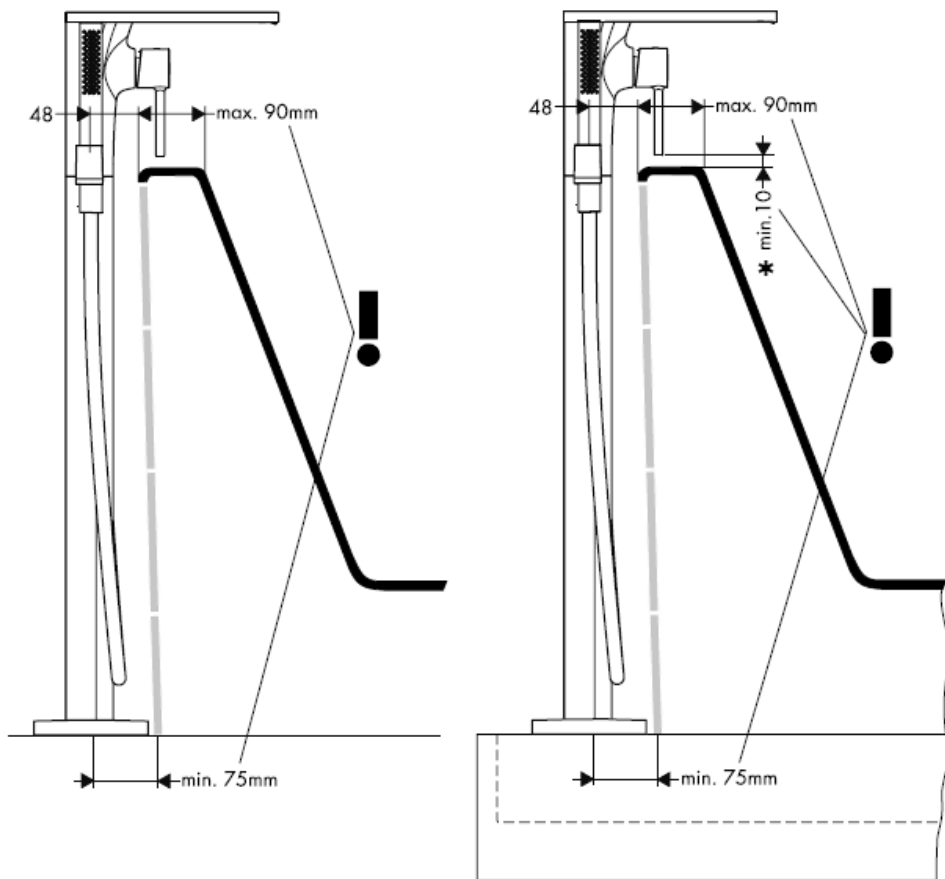

* < 10 min = pikendus 60 mm (artikli number 97686000)

Citterio 39451000

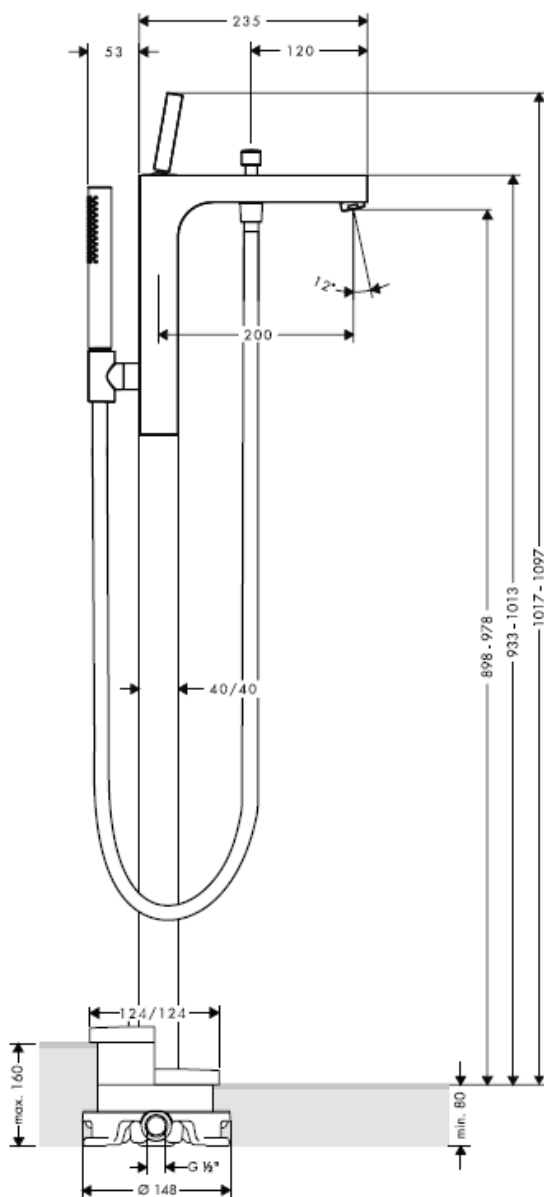

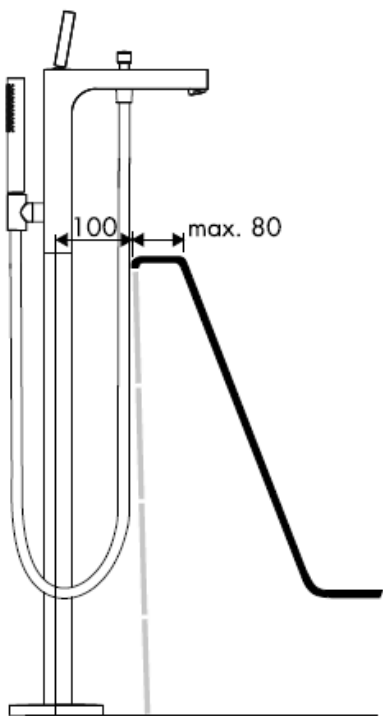

Tähelepanu! Segisti paigaldamine, loputamine ja kontroll peab toimuma vastavalt kehtivatele normidele!

Starck 10452180

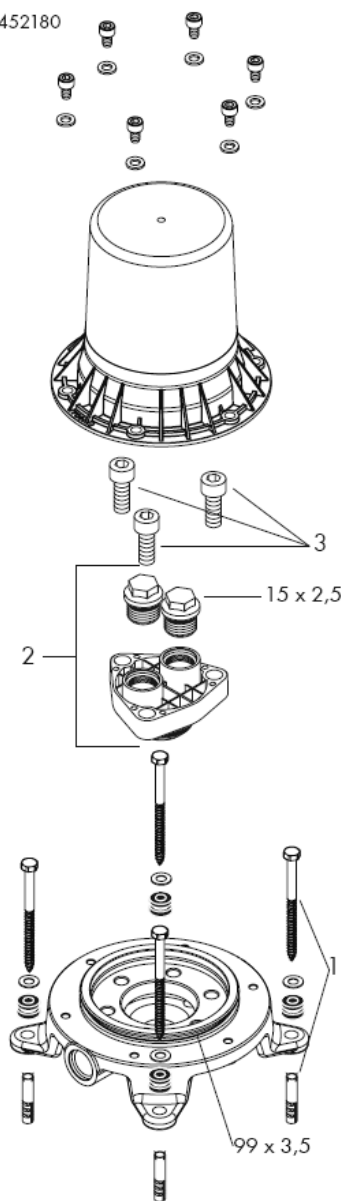

Montreux 16549180

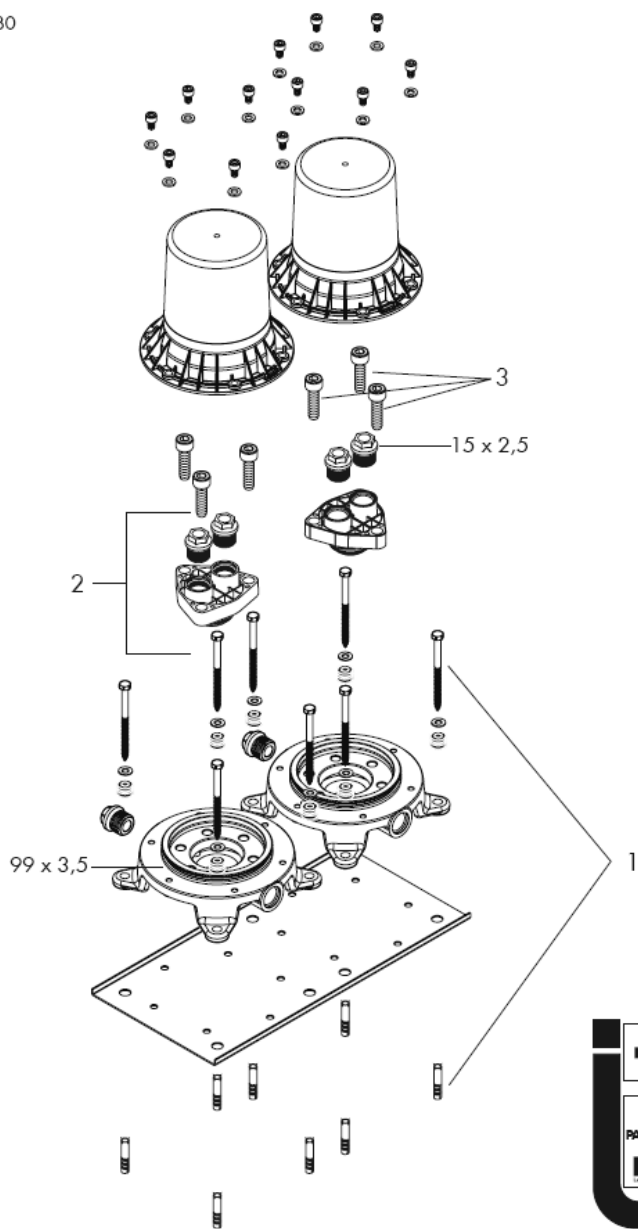

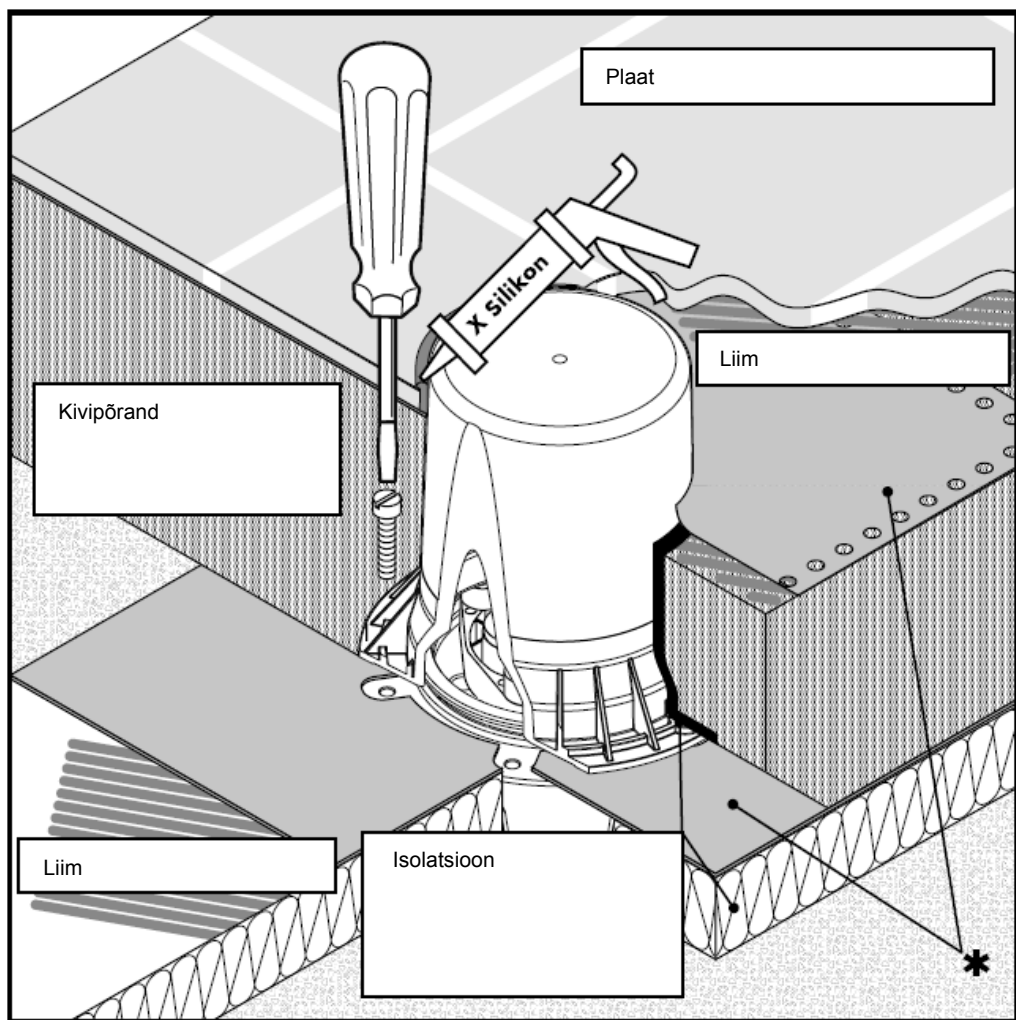

* Vajadusel tellige eraldi tihend

X Silikoon (äädikhappeta!)

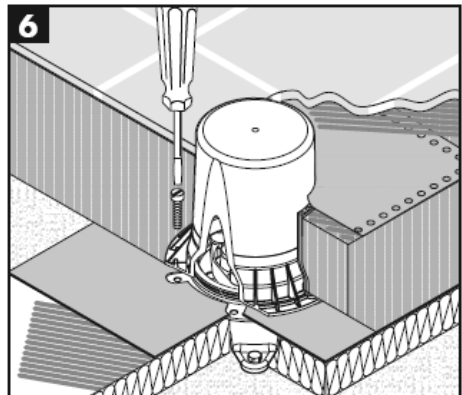
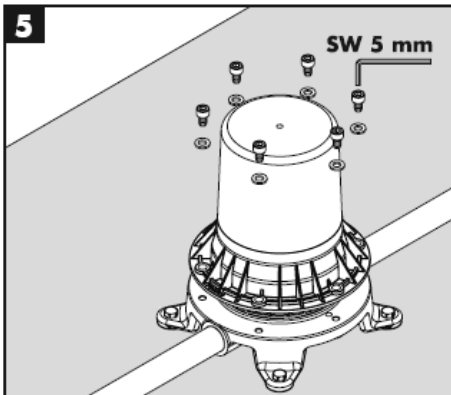
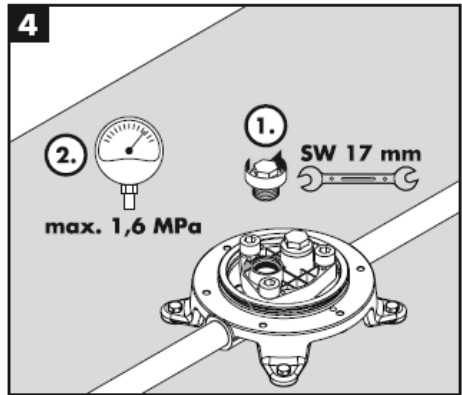
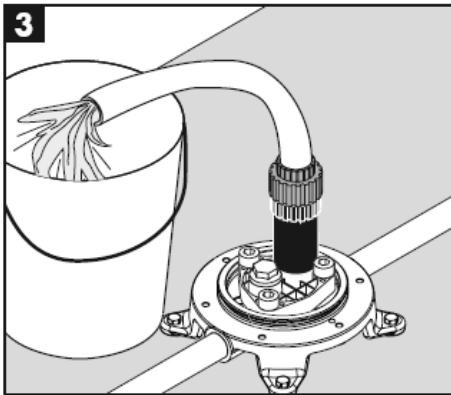
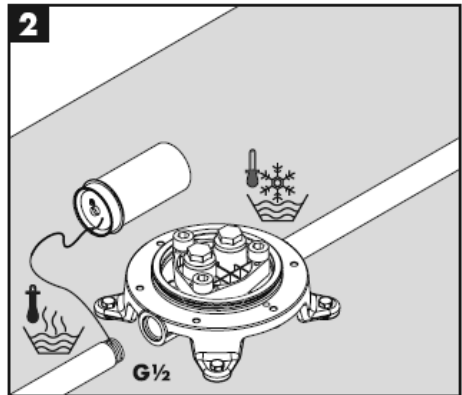
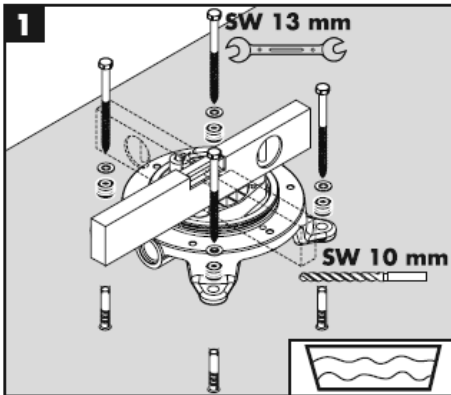

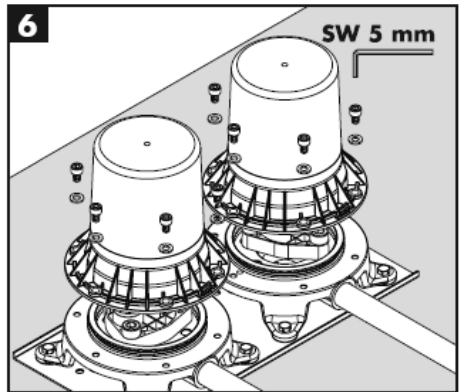
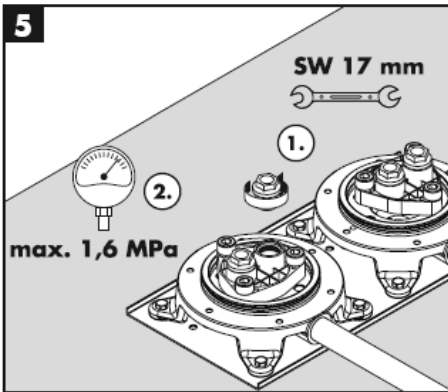
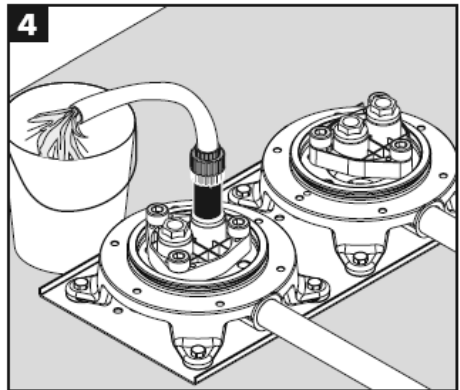
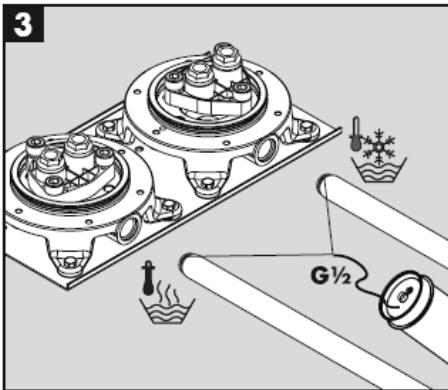
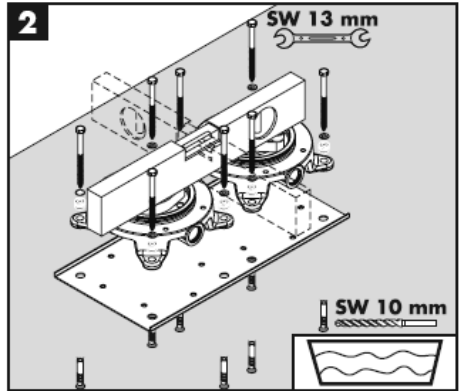
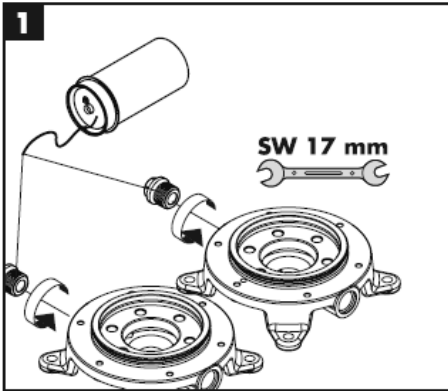

Paigaldamine

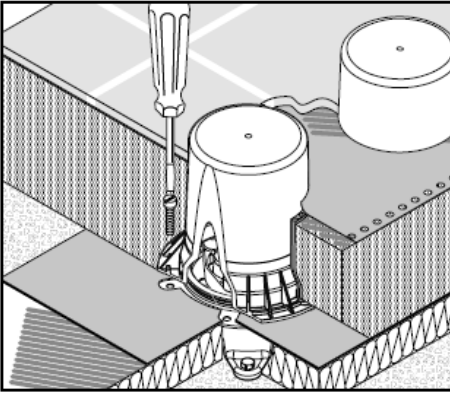

Estonia

Tehnilised andmed

Töörõhk	max. 1 MPa
Soovitav töörõhk:	0,1 – 0,5 MPa
Kontrollsurve: (1 MPa = 10 baari = 147 PSI)	1,6 MPa
Kuuma vee temperatuur:	max. 80° C
Soovitav kuuma vee temperatuur:	65° C

Varuosad vt lk 10 – 11

paigaldus komplekt	96260000
tihendite komplekt	96459000
kuusnurkne kruvi M 10 x 35	97670000

Spetsiaalne lisavarustus

* tihendi (ei sisaldu komplektis)	96441000
--------------------------------------	----------

Kontrollsertifikaat

	DVGW	P-IX	SVGW	ACS	NF	WRAS	KIWA
10452180				x		X	
16549180		PA-IX 18729/ICB					

hansgrohe

Montāžas instrukcija

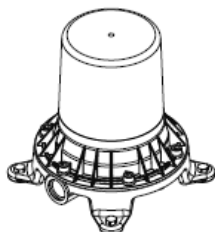

Starck
10452180

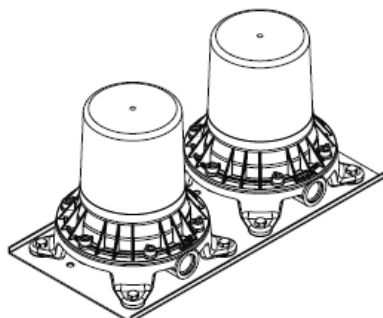

Montreux
16549180

AXOR[®]

hansgrohe

Starck 10458XXX

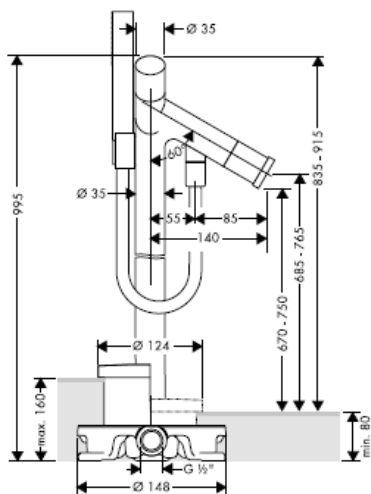

Starck 10060XXX

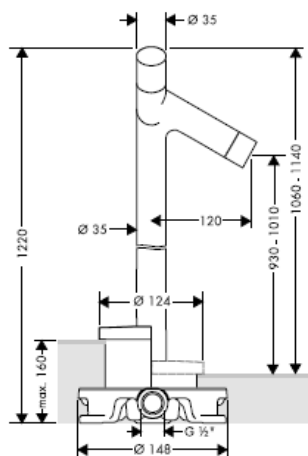

Starck 10456XXX

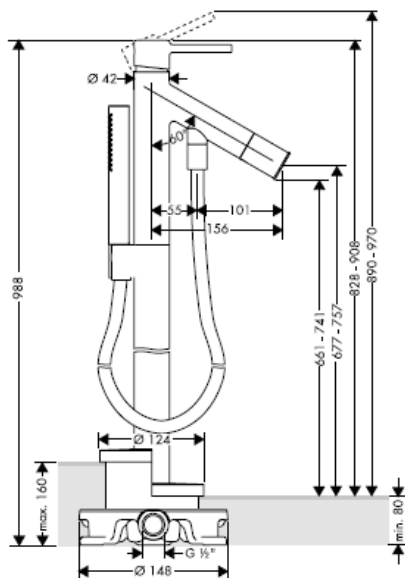

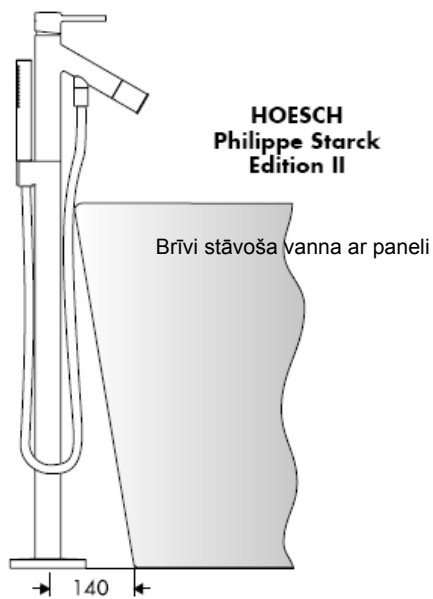
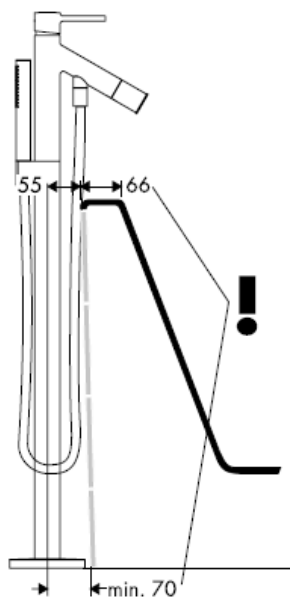
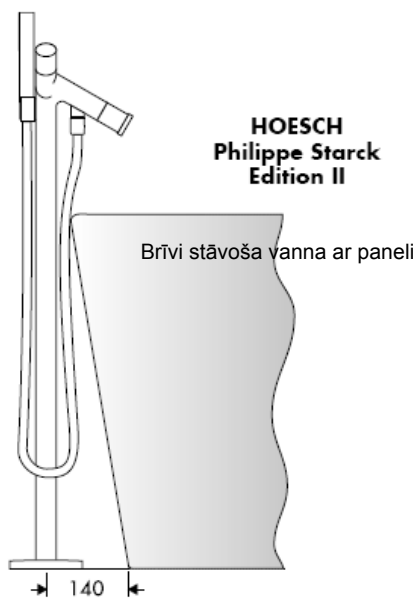

Starck X 10406000

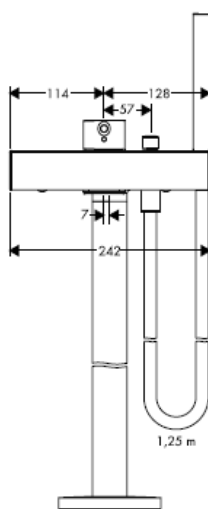
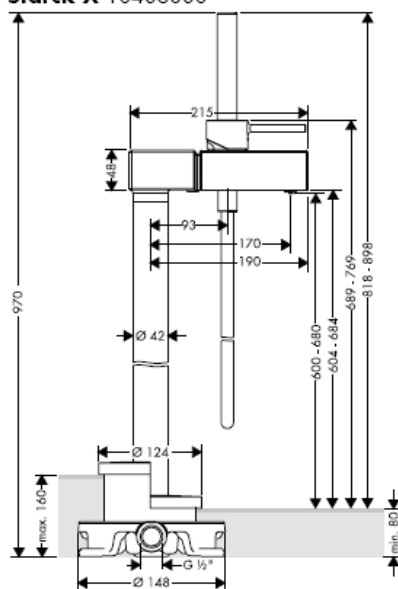

Montreux 16547XXX

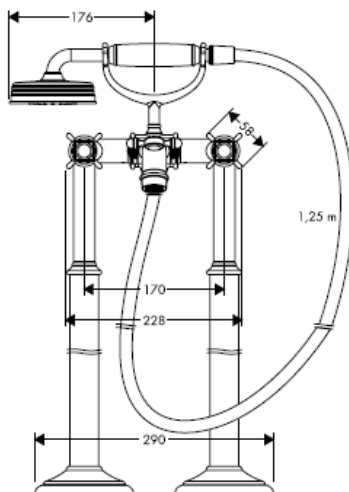
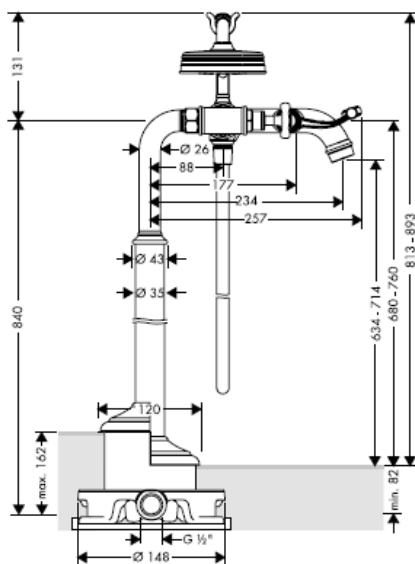

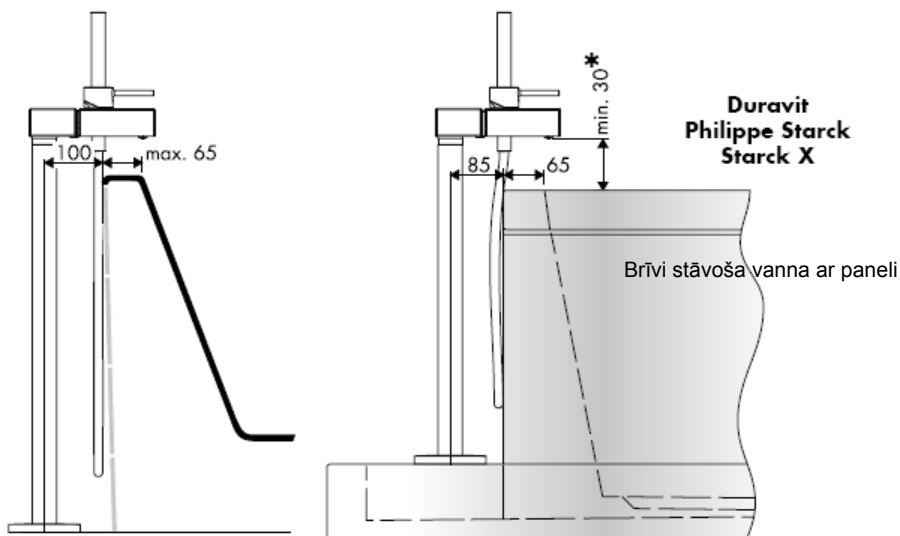

* < 30 min = Pagarinājums 60 mm (artikula numurs 97686000)

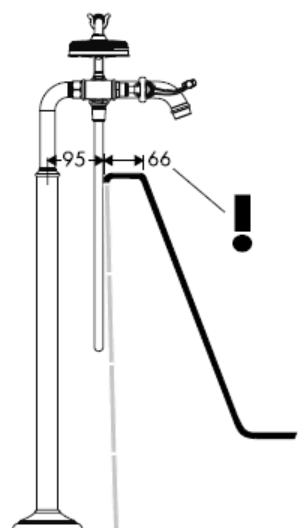

Massaud 18450000

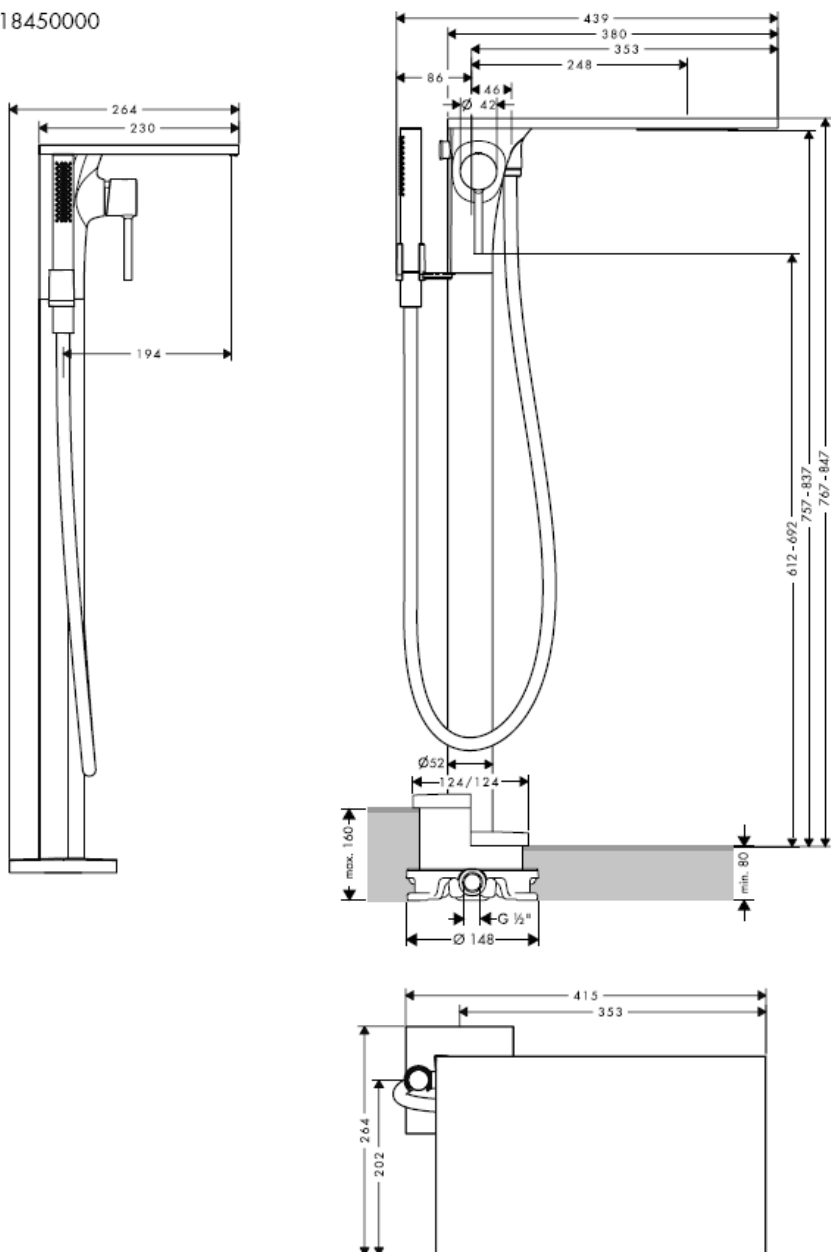

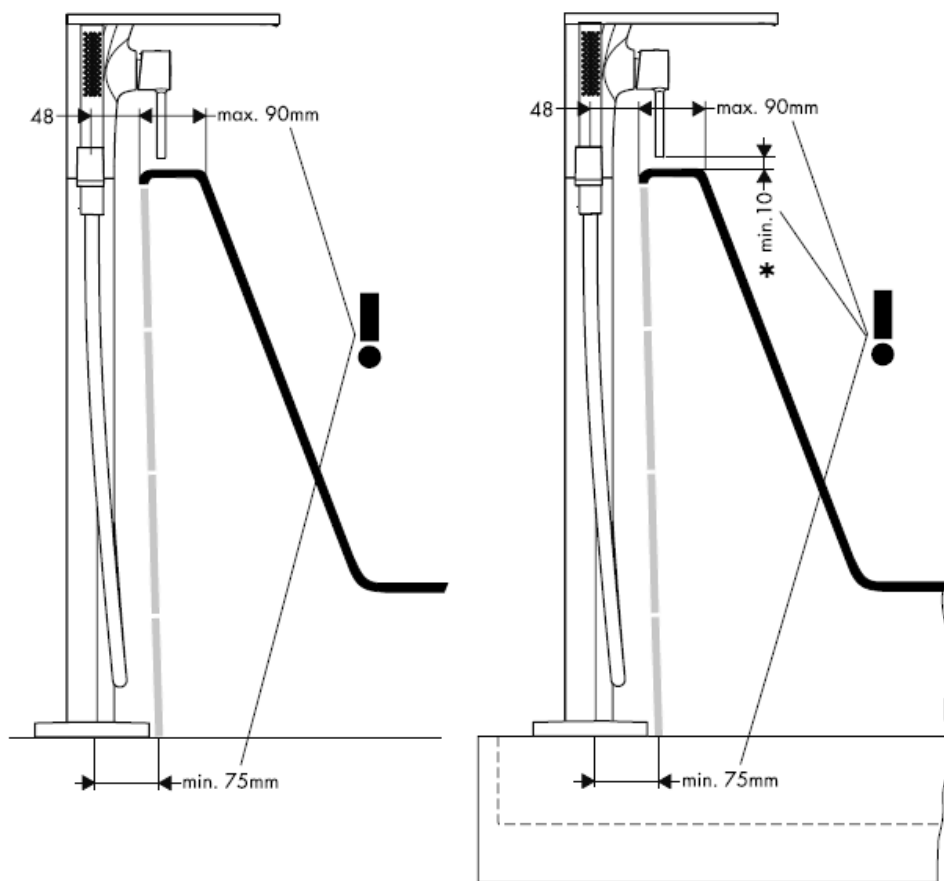

* < 10 min = Pagarinājums 60 mm (artikula numurs 97686000)

Citterio 39451000

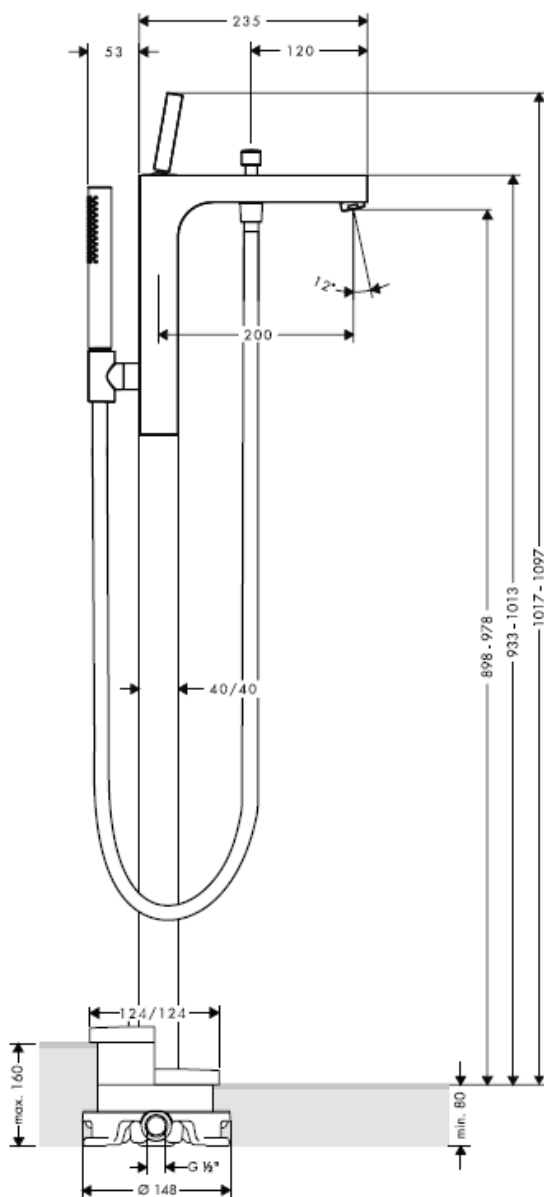

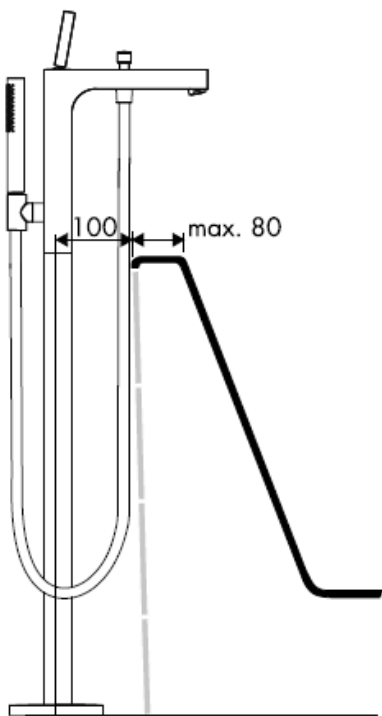

Uzmanību! Armatūra jāuzstāda, jāizskalo un jāpārbauda atbilstoši spēkā esošajām normām!

Starck 10452180

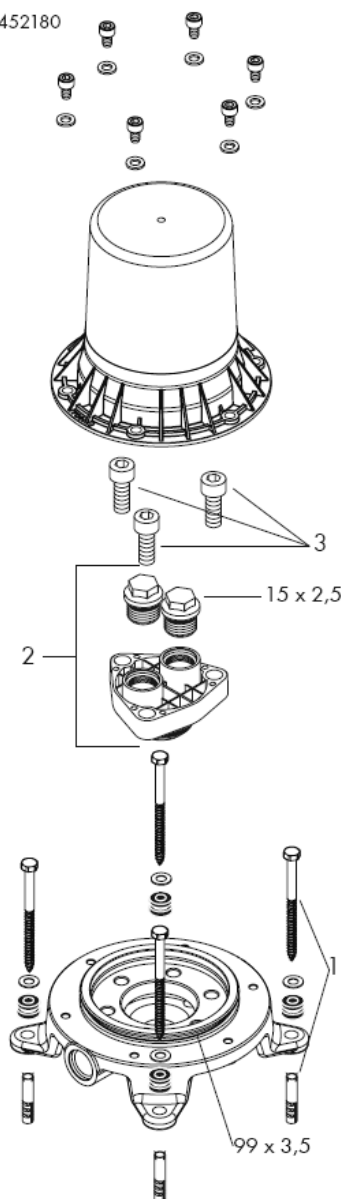

Montreux 16549180

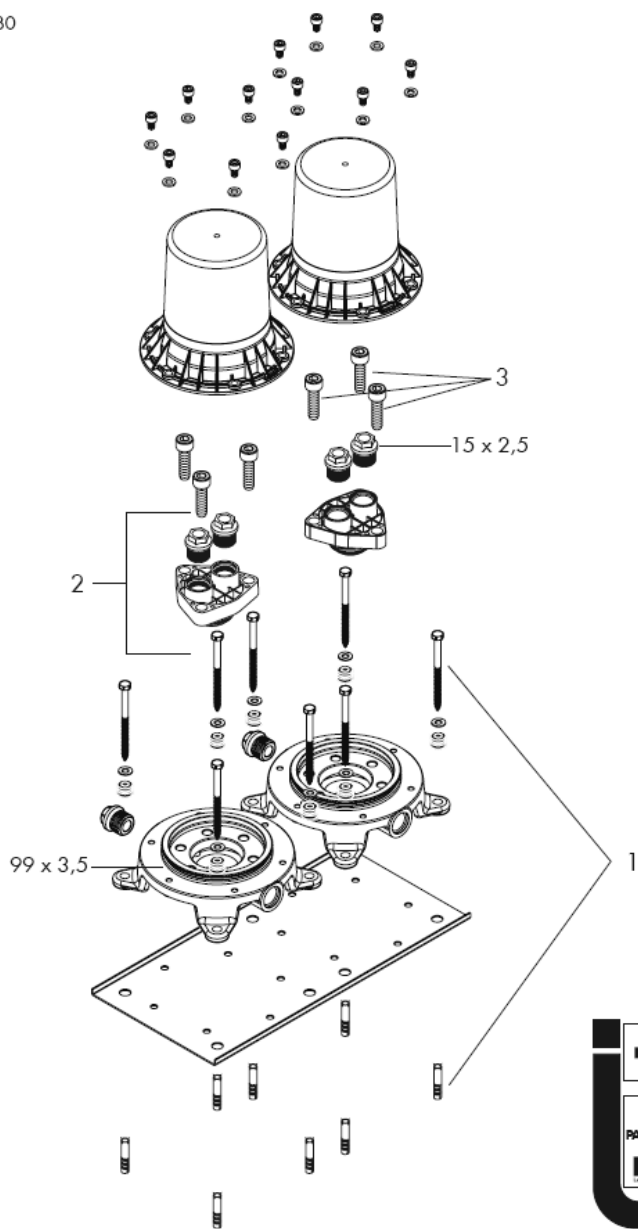

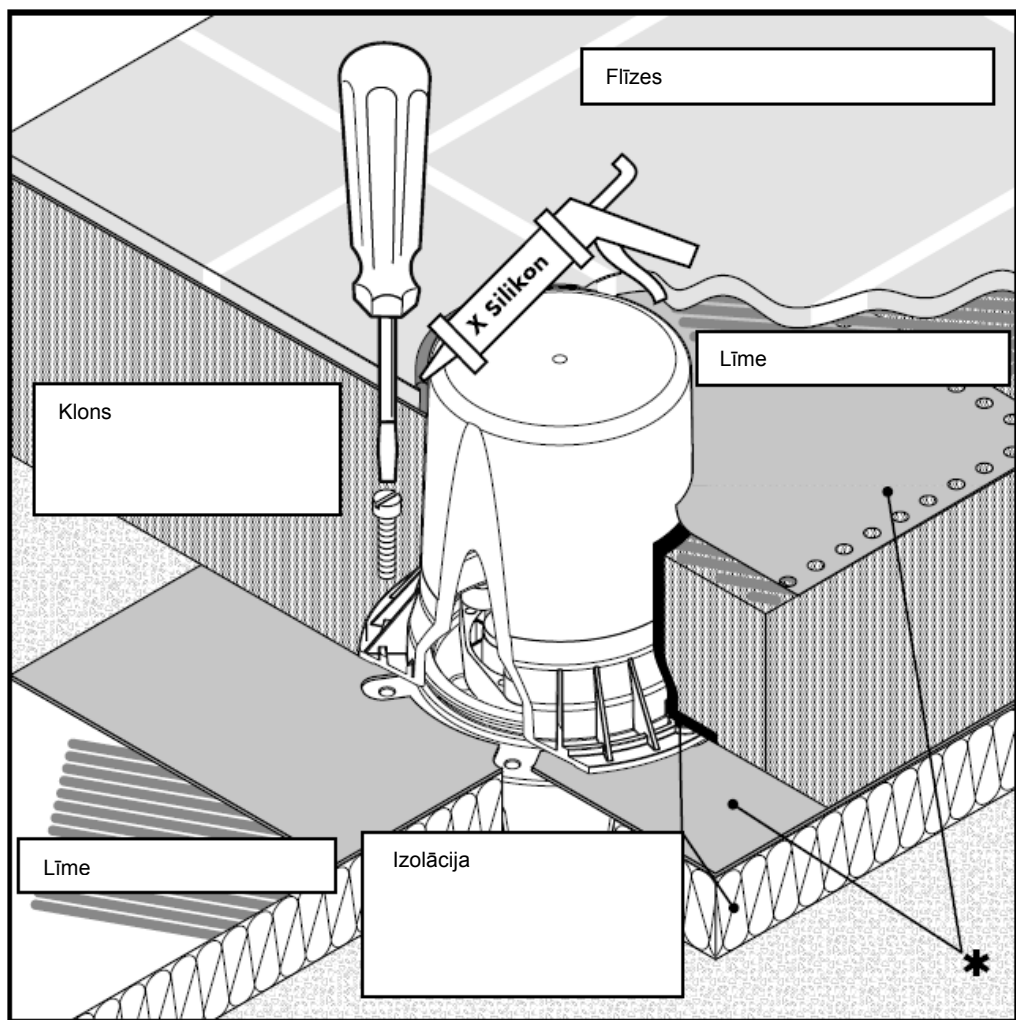

* Atsevišķi pasūtāma blīvējuma uzmava

X Silikons (etiķskābi nesaturošs!)

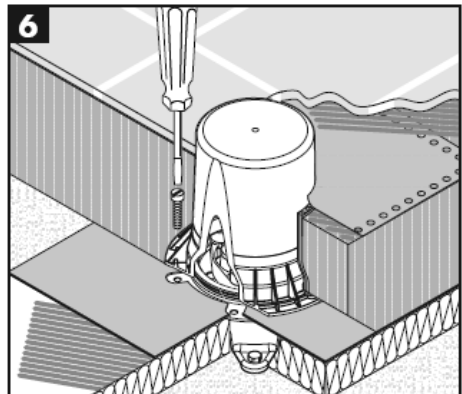
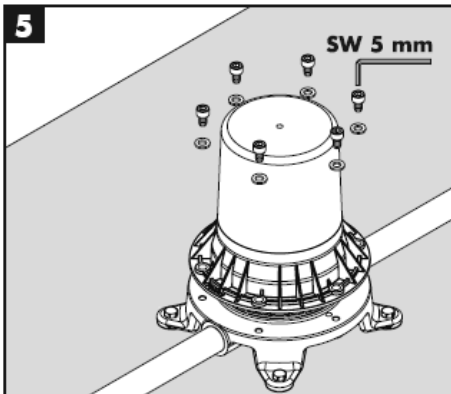
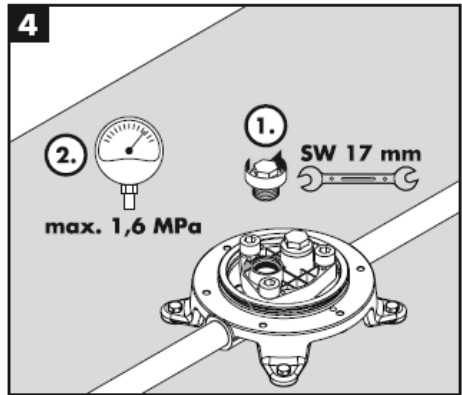
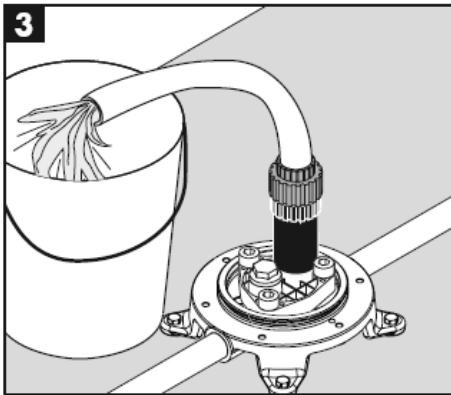
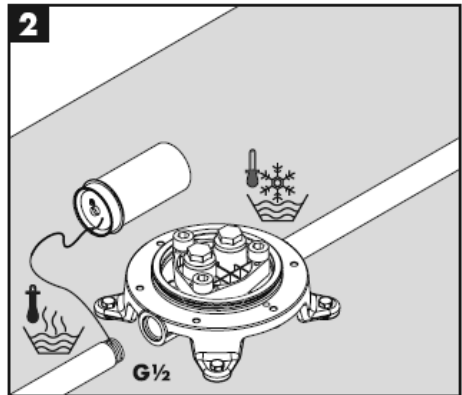
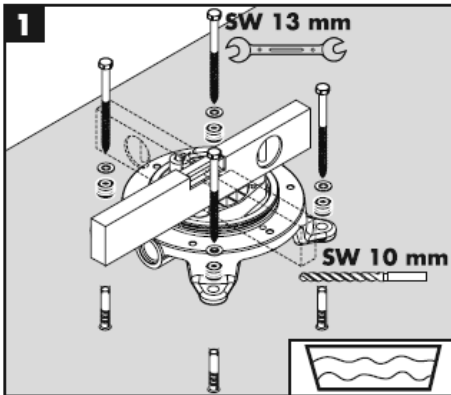

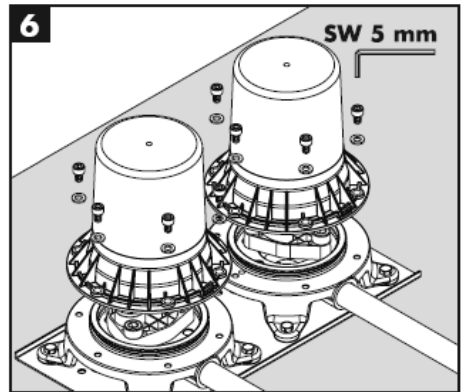
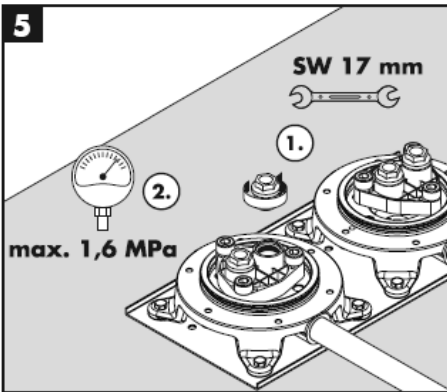
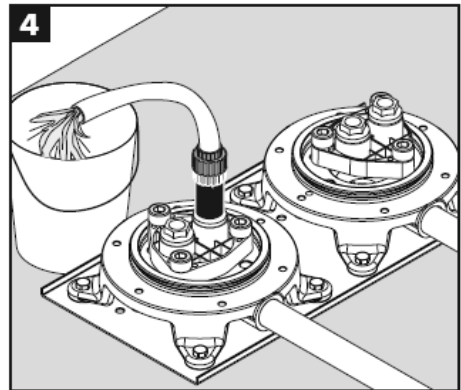
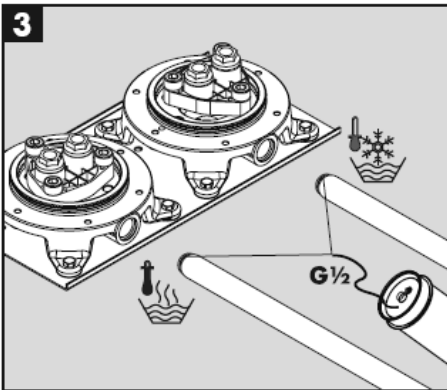
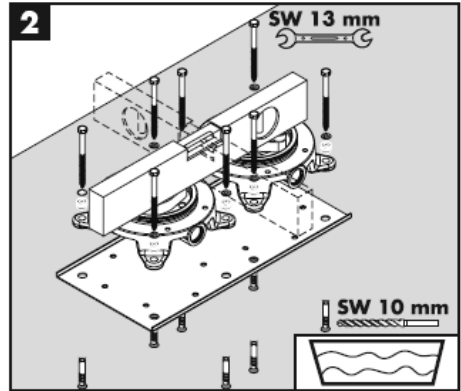
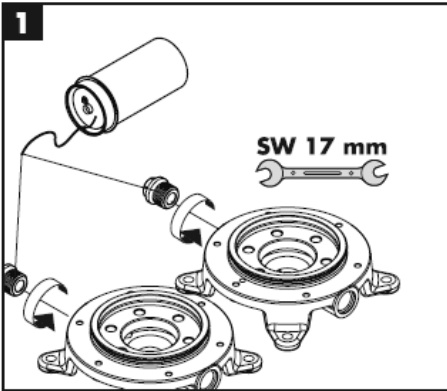

Montāža

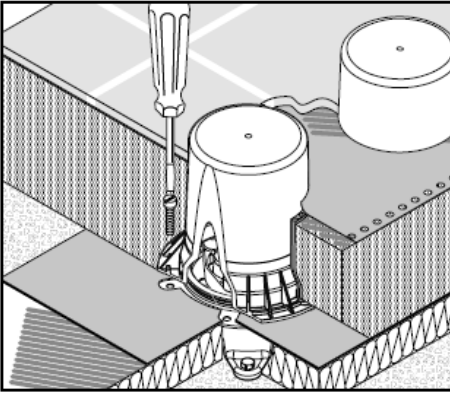

Latviski

Tehniskie dati

Darba spiediens: max. 1 MPa
Ieteicamais darba spiediens: 0,1 – 0,5 MPa
Pārbaudes spiediens: 1,6 MPa
(1 MPa = 10 bar = 147 PSI)
Karstā ūdens temperatūra: max. 80° C
Ieteicamā karstā ūdens temperatūra: 65° C

Rezerves daļas skat. lpp. 10 – 11

Stiprinājuma komplekts 96260000
Blīvju komplekts 96459000
Cilindriskā skrūve M 10 x 35 97670000

Speciāli aksesuāri

* Blīvējuma uzdeva 96441000
(komplektā netiek piegādāts)

Pārbaudes zīme

	DVGW	P-IX	SVGW	ACS	NF	WRAS	KIWA
10452180				x		X	
16549180		PA-IX 18729/ICB					

hansgrohe

Uputstvo za montažu

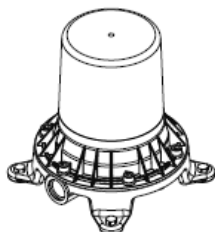

Starck
10452180

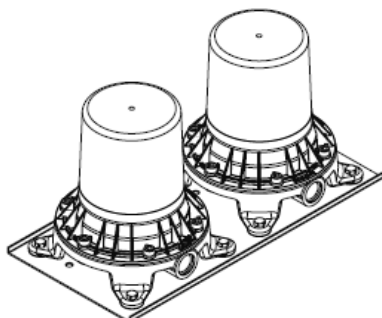

Montreux
16549180

AXOR[®]

hansgrohe

Starck 10458XXX

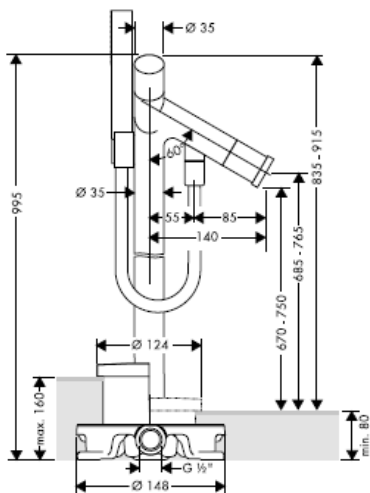

Starck 10060XXX

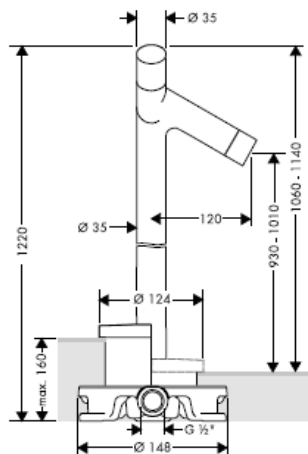

Starck 10456XXX

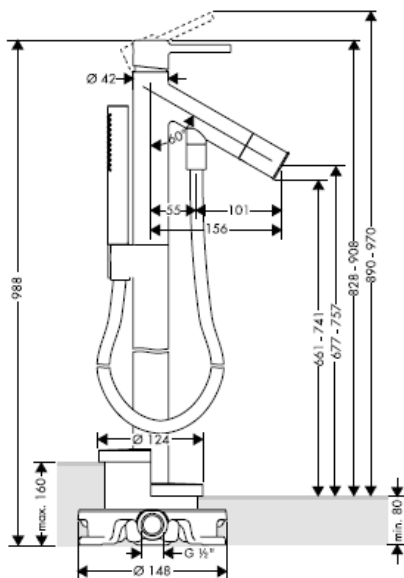

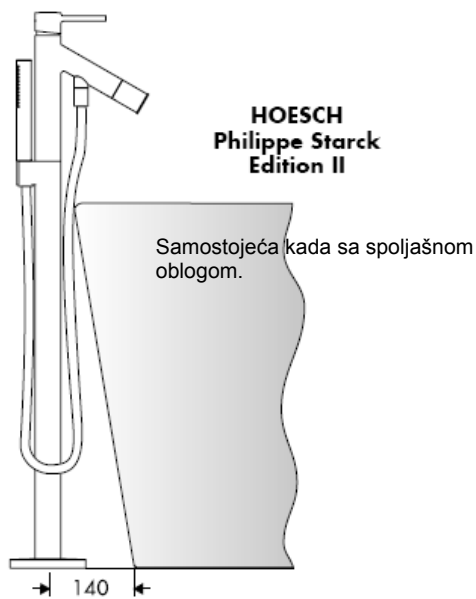
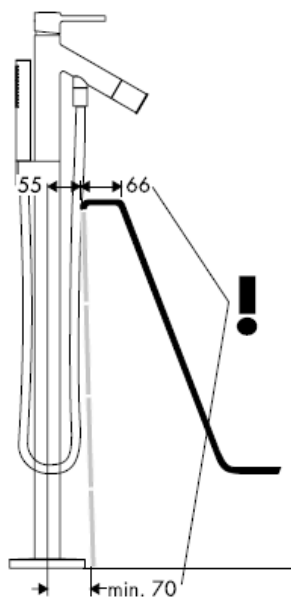
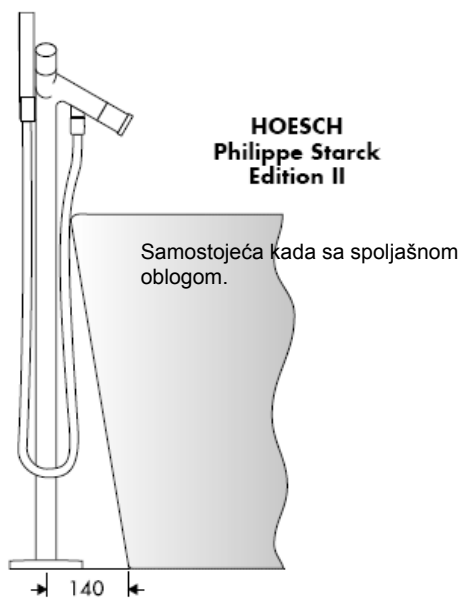

Starck X 10406000

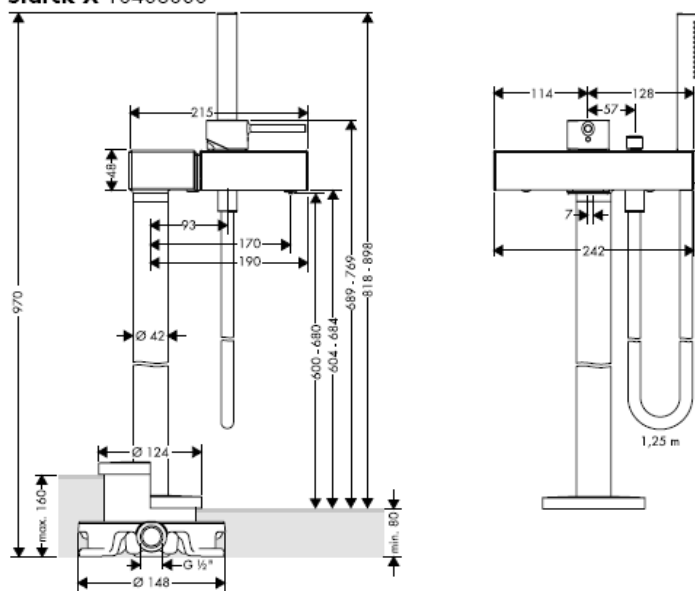

Montreux 16547XXX

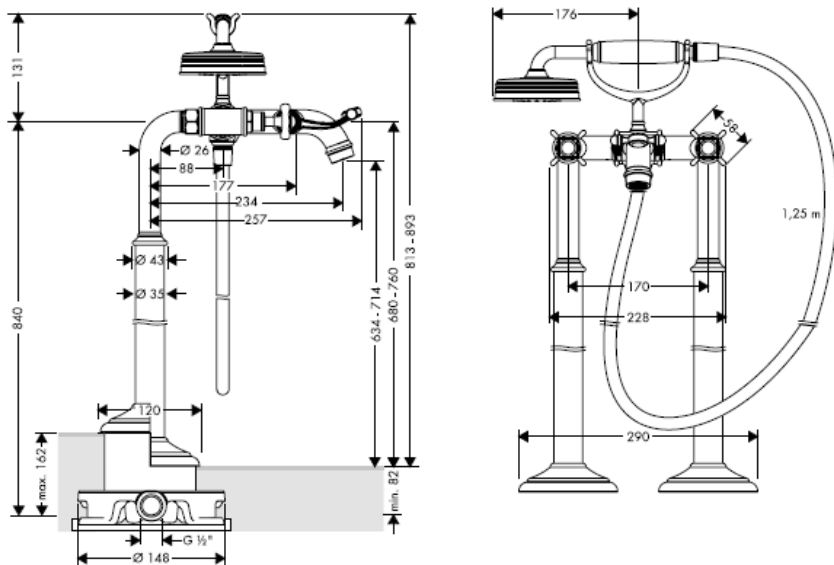

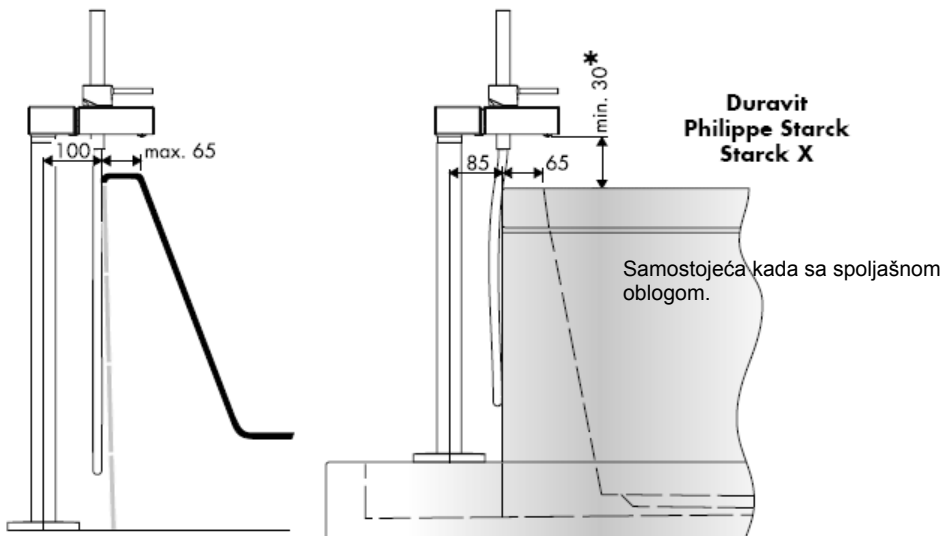

* < 30 min = Produžetak 60 mm (br. Proizvoda 97686000)



Massaud 18450000

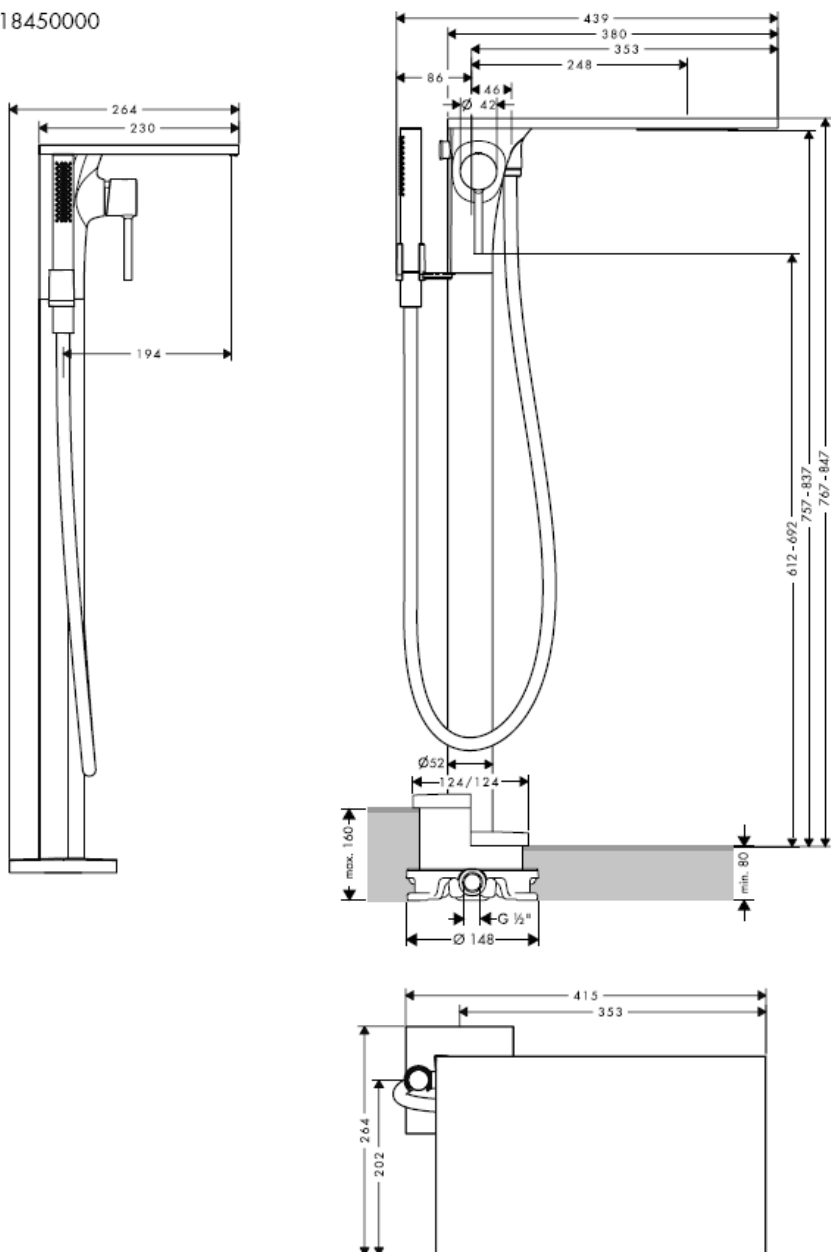

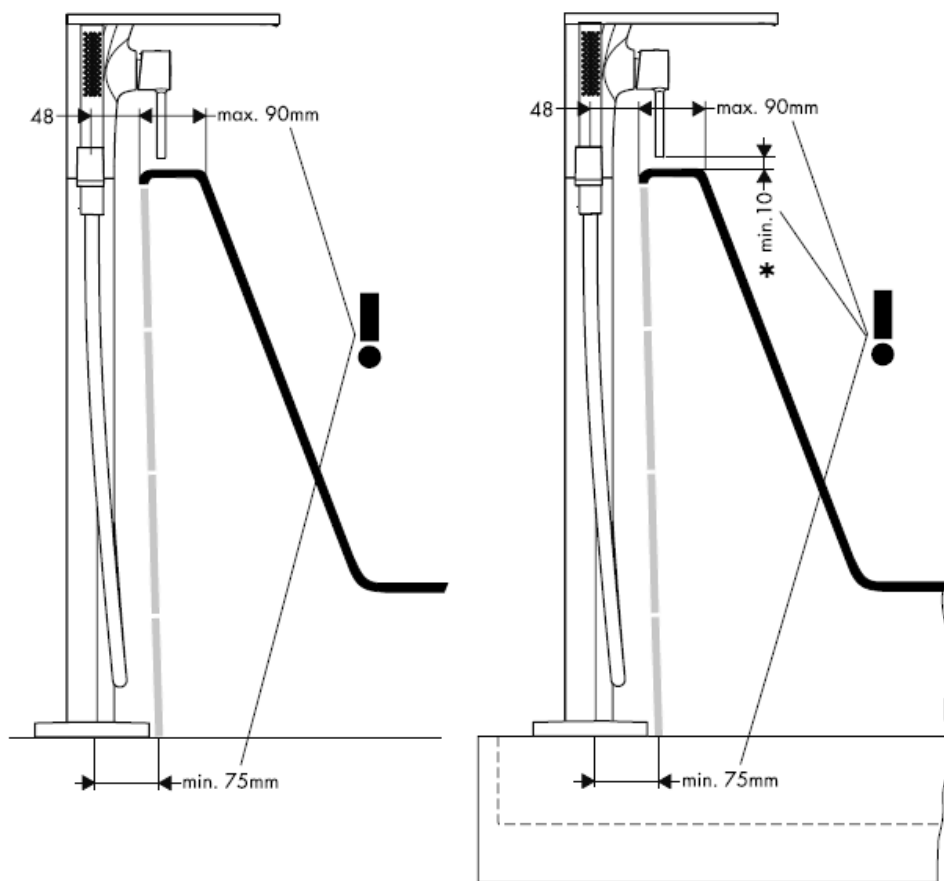

* < 10 min = Produžetak 60 mm (br. Proizvoda 97686000)

Citterio 39451000

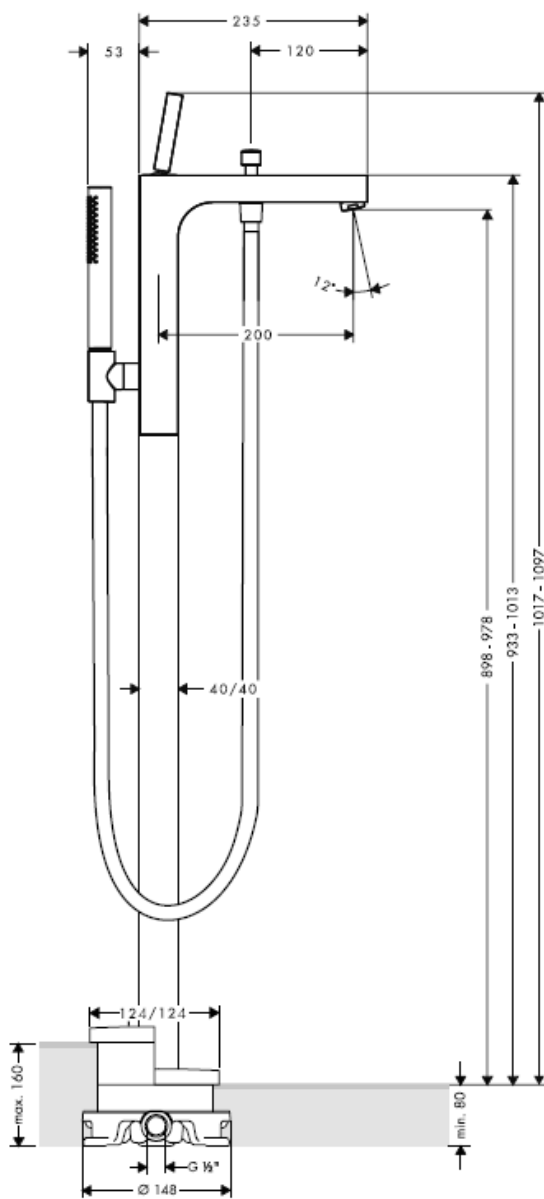

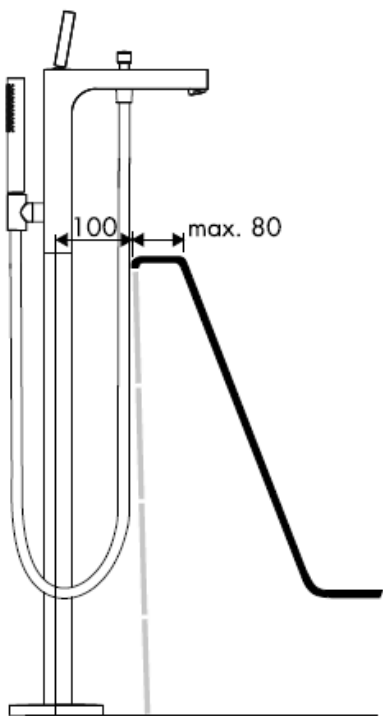

Pažnja! Armatura mora biti postavljena, isprana i testirana prema važećim normama!

Starck 10452180

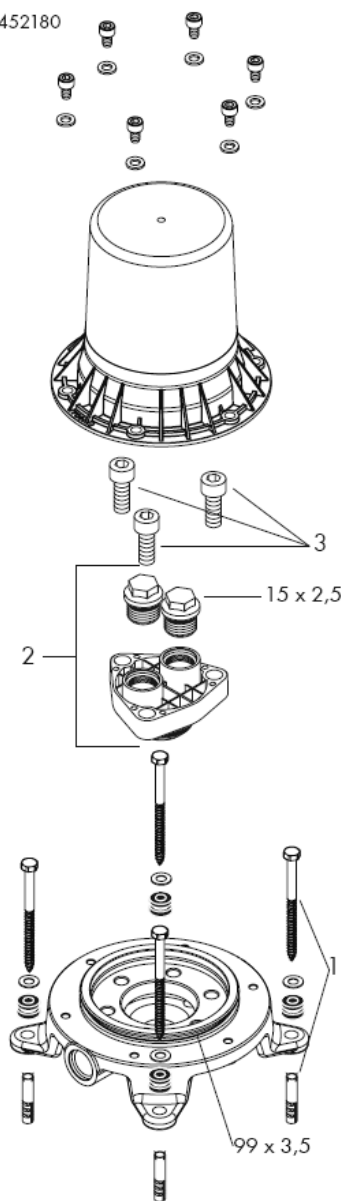

Montreux 16549180

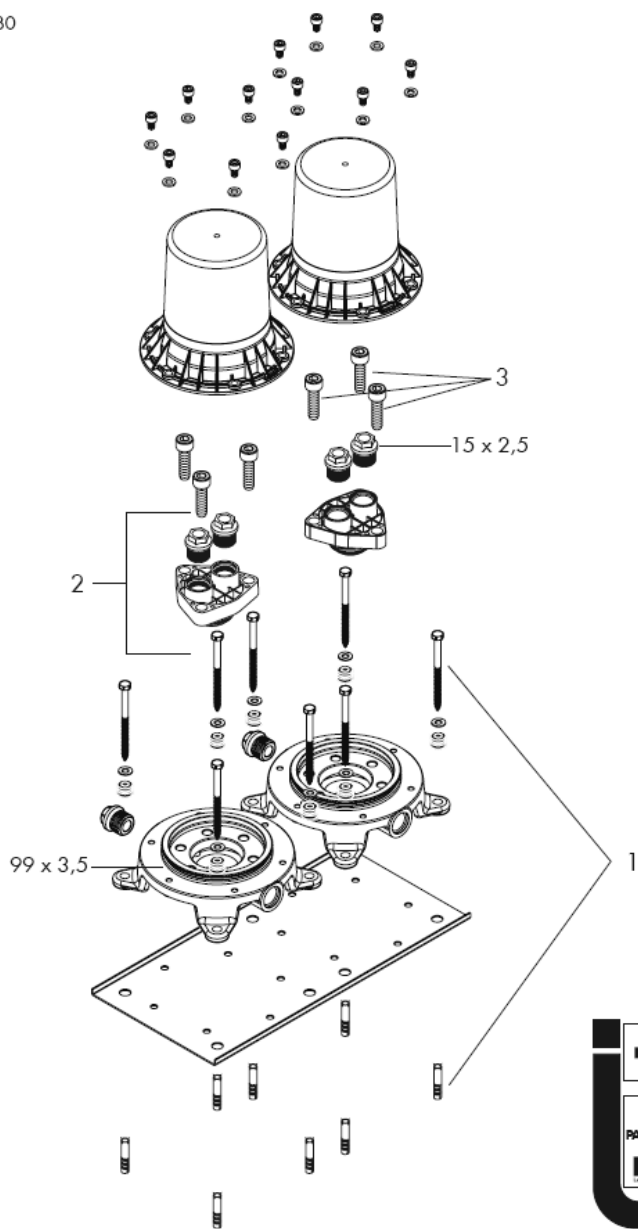

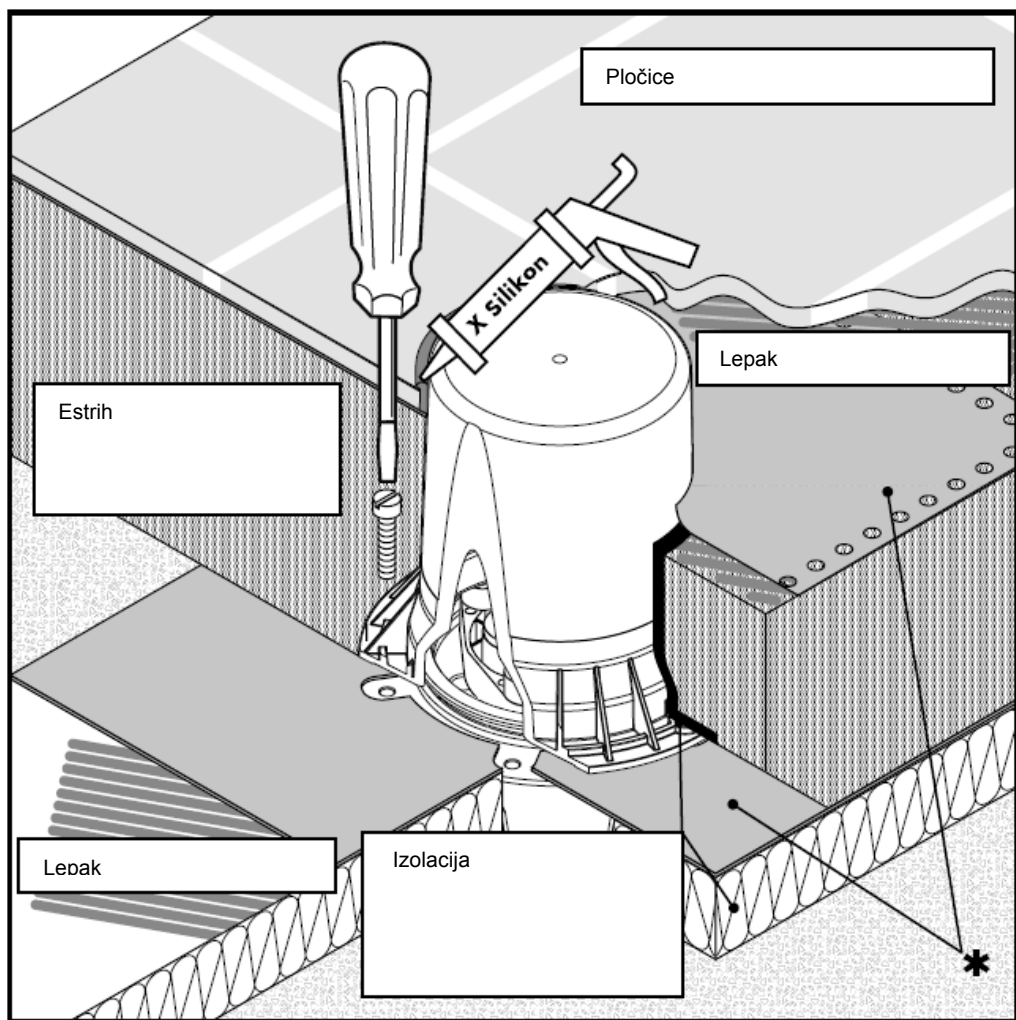

* Zaptivne manžetne - mogu se naručiti

X Silikon (ne sadrži sirćetnu kiselinu!)

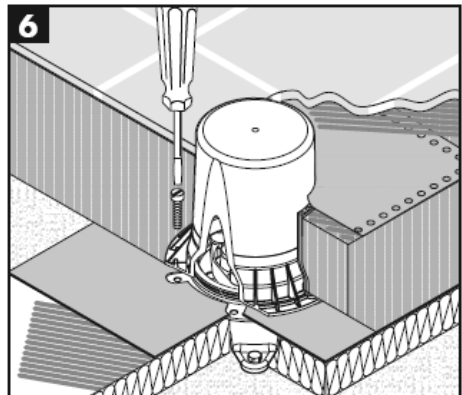
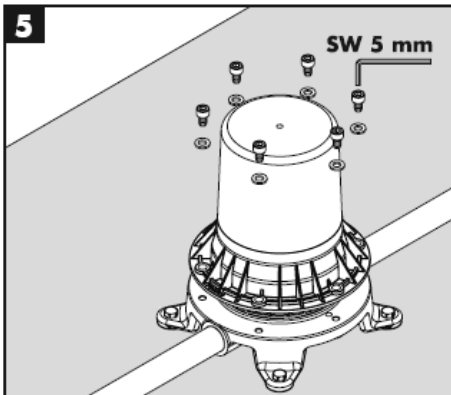
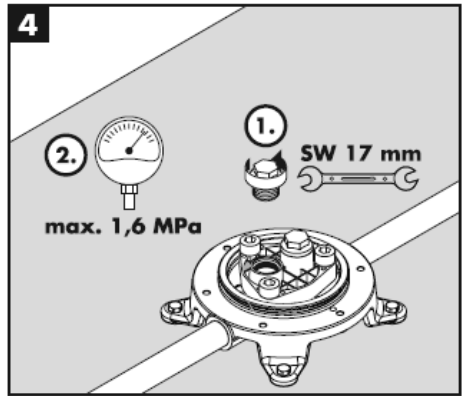
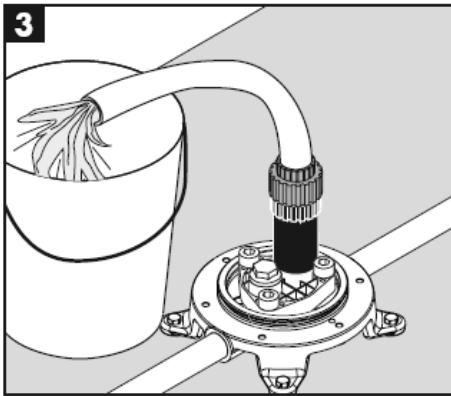
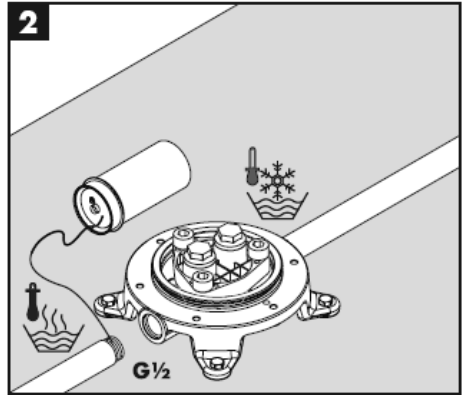
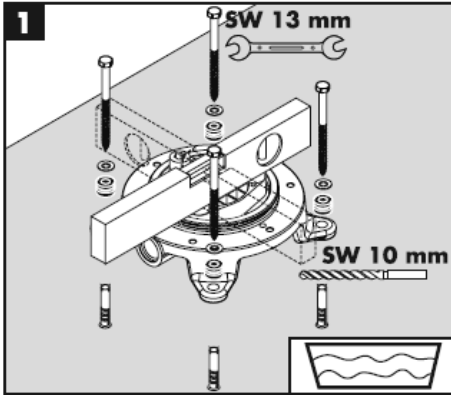

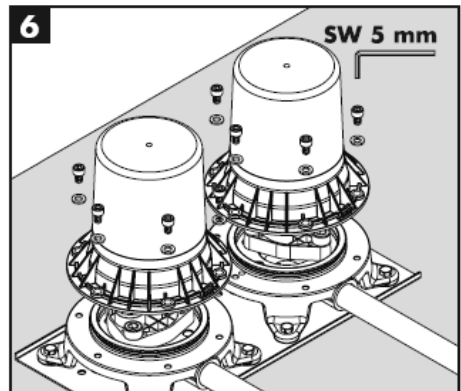
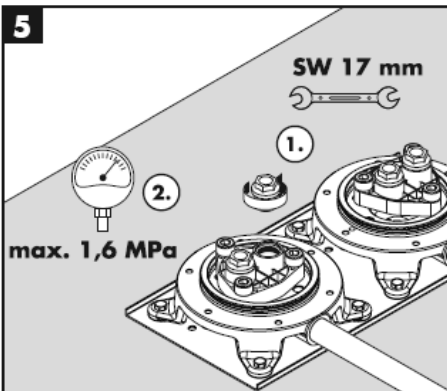
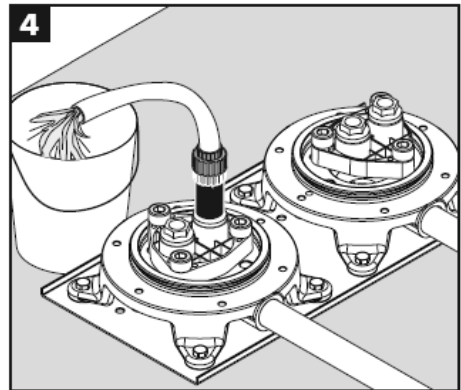
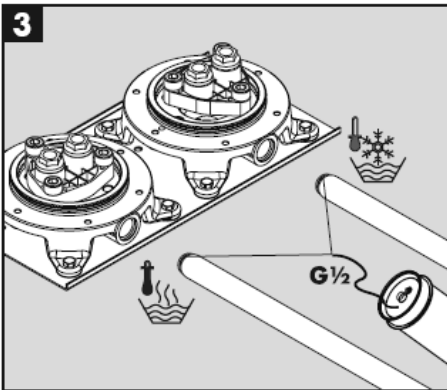
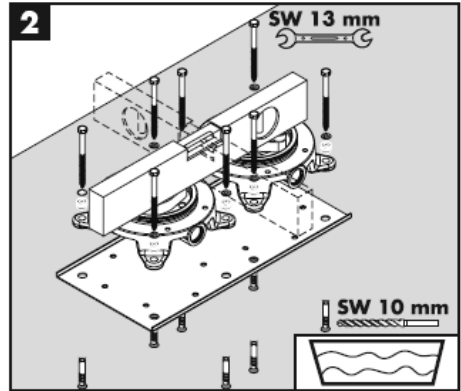
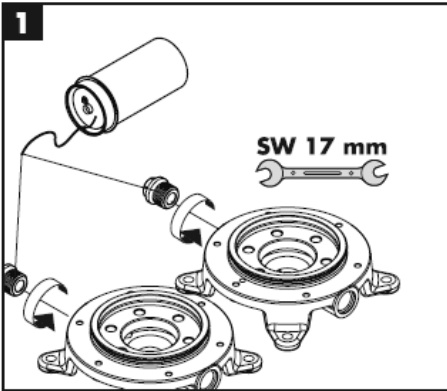

Montaža

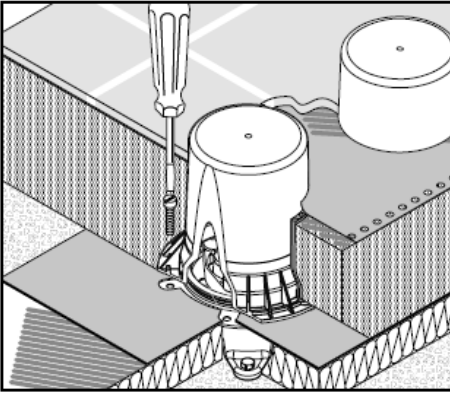

Srpski

Tehnički podaci

Radni pritisak:	max. 1 MPa
Preporučeni radni pritisak:	0,1 – 0,5 MPa
Probni pritisak:	1,6 MPa
(1 MPa = 10 bar = 147 PSI)	
Temperatura vruće vode:	max. 80° C
Preporučena temperatura vruće vode:	65° C

Rezervni delovi vidi stranu 10 – 11

garnitura za pričvršćivanje	96260000
Garnitura za zaptivanje	96459000
Cilindrični zavrtanj M 10 x 35	97670000

Poseban pribor

* Zaptivna manžetna (Nije sadržano u isporuci)	96441000
---	----------

Ispitni znak

	DVGW	P-IX	SVGW	ACS	NF	WRAS	KIWA
10452180				x		X	
16549180		PA-IX 18729/ICB					

hansgrohe

Montasjeveiledning

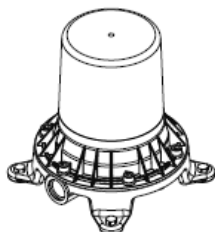

Starck
10452180

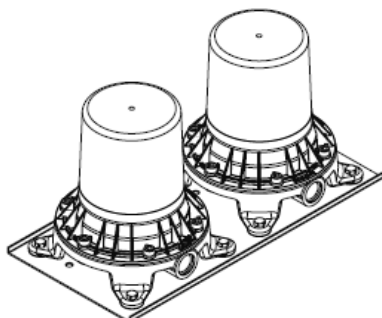

Montreux
16549180

AXOR[®]

hansgrohe

Starck 10458XXX

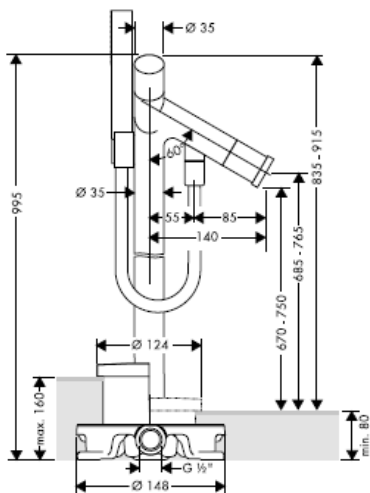

Starck 10060XXX

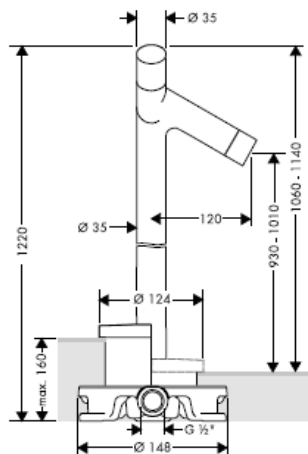

Starck 10456XXX

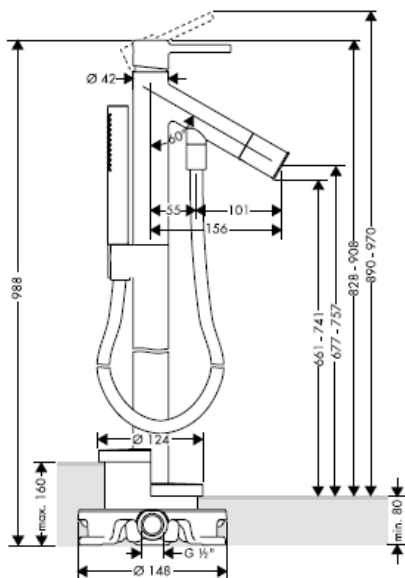

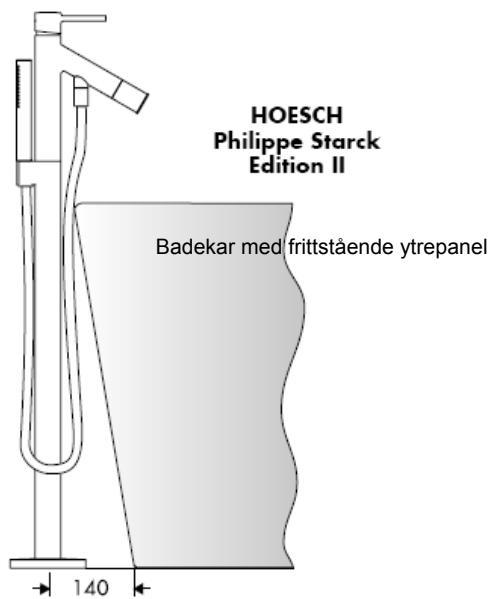
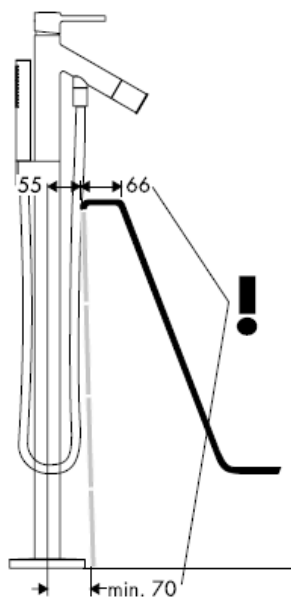
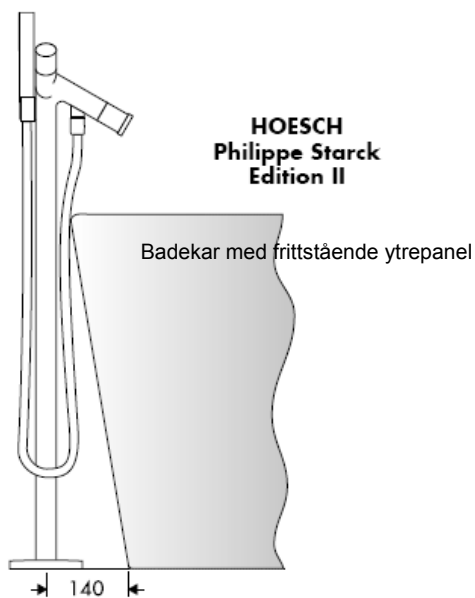

Starck X 10406000

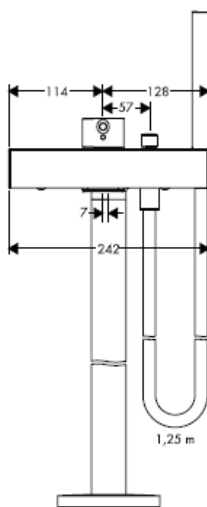
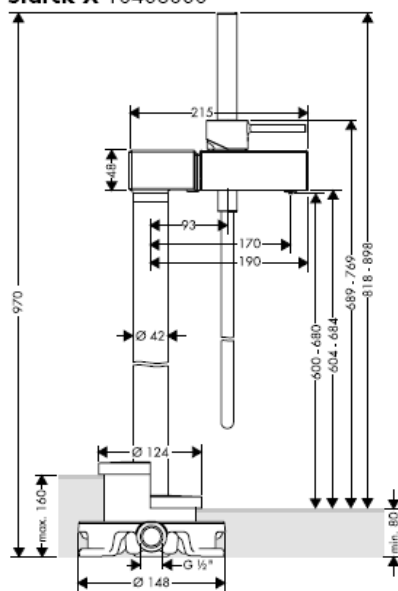

Montreux 16547XXX

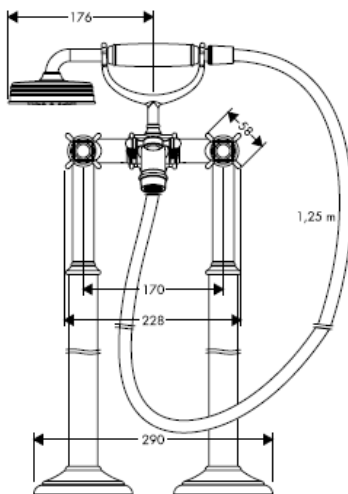
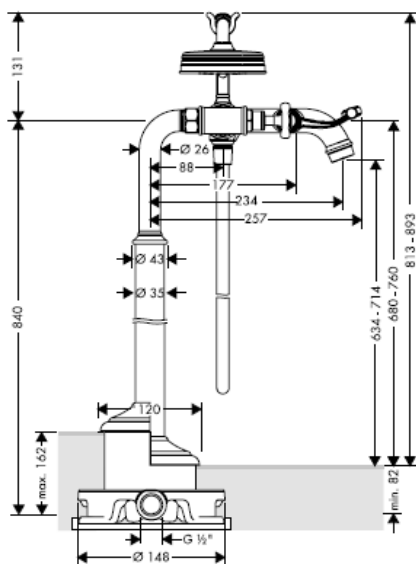

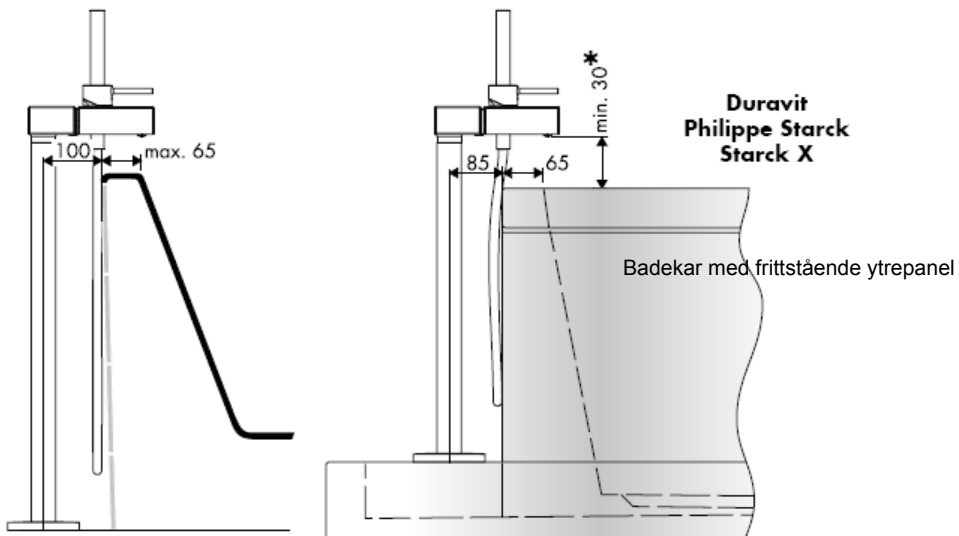

* < 30 min = Forlengelse 60 mm (Artikkelnummer 97686000)



Massaud 18450000

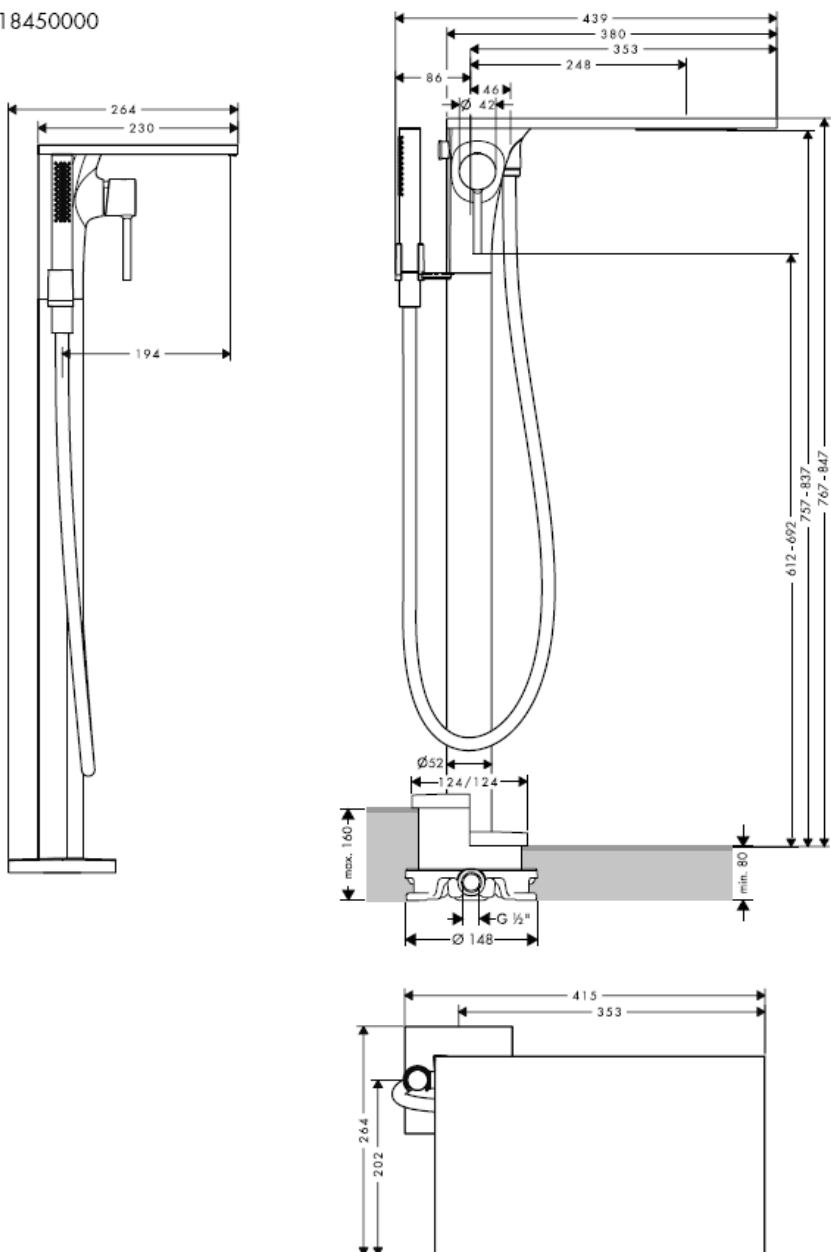

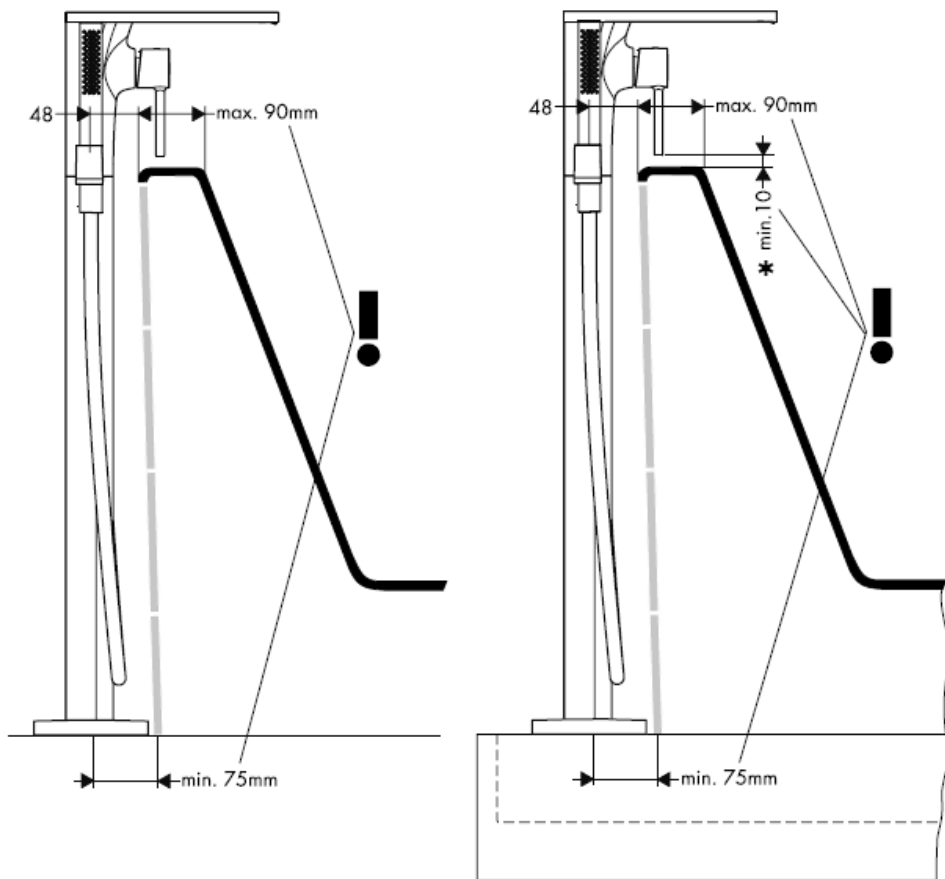

* < 10 min = Forlængelse 60 mm (Artikelnummer 97686000)

Citterio 39451000

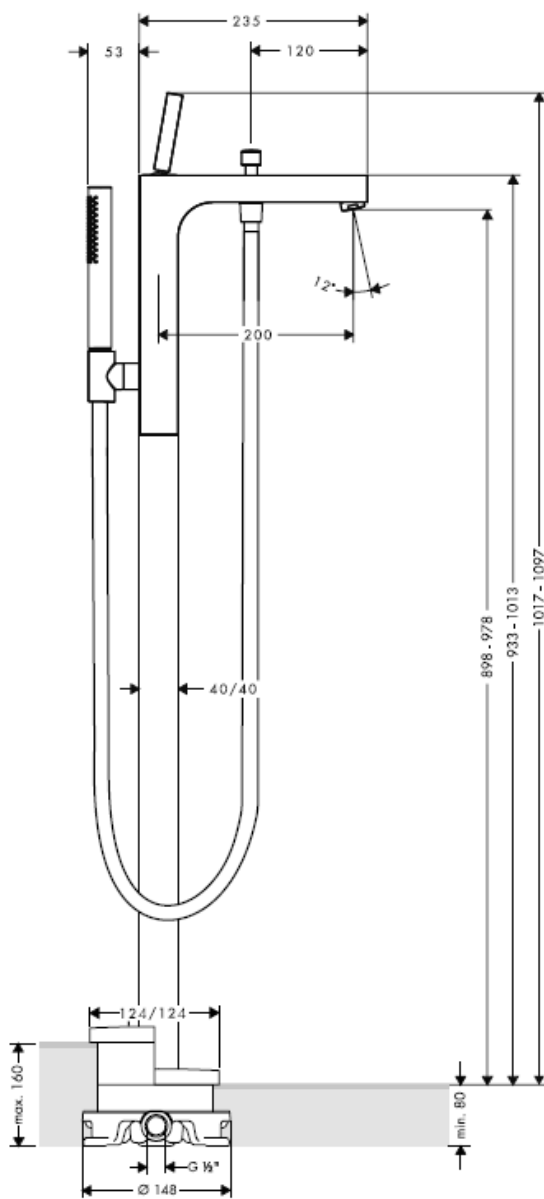

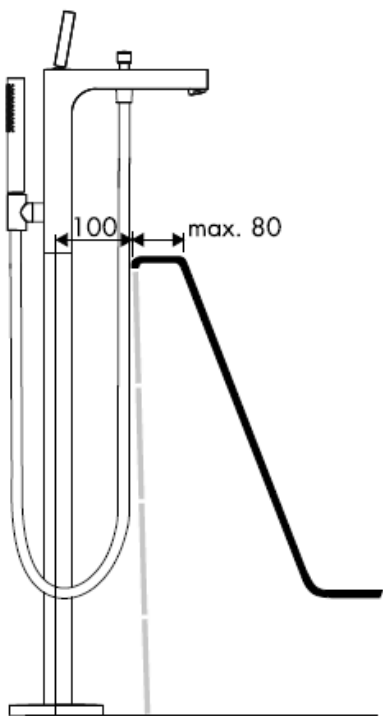

Obs! Armaturen skal monteres iht. gyldige standarder. De skal spyles og sjekkes!

Starck 10452180

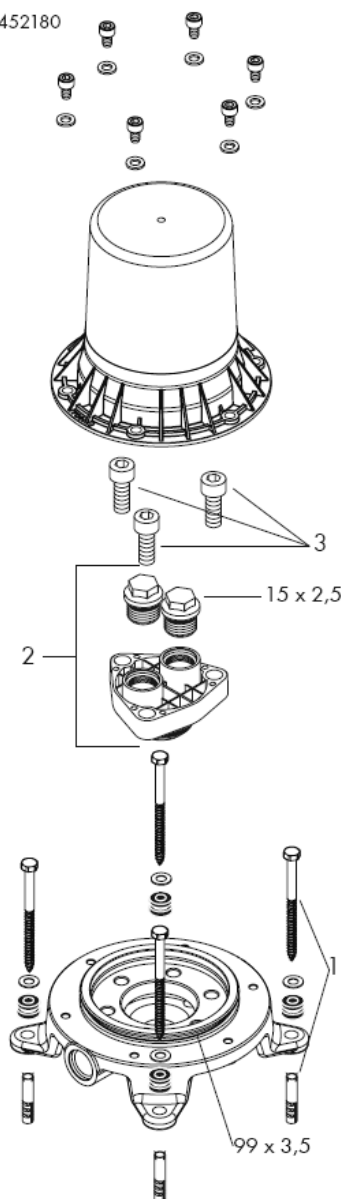

Montreux 16549180

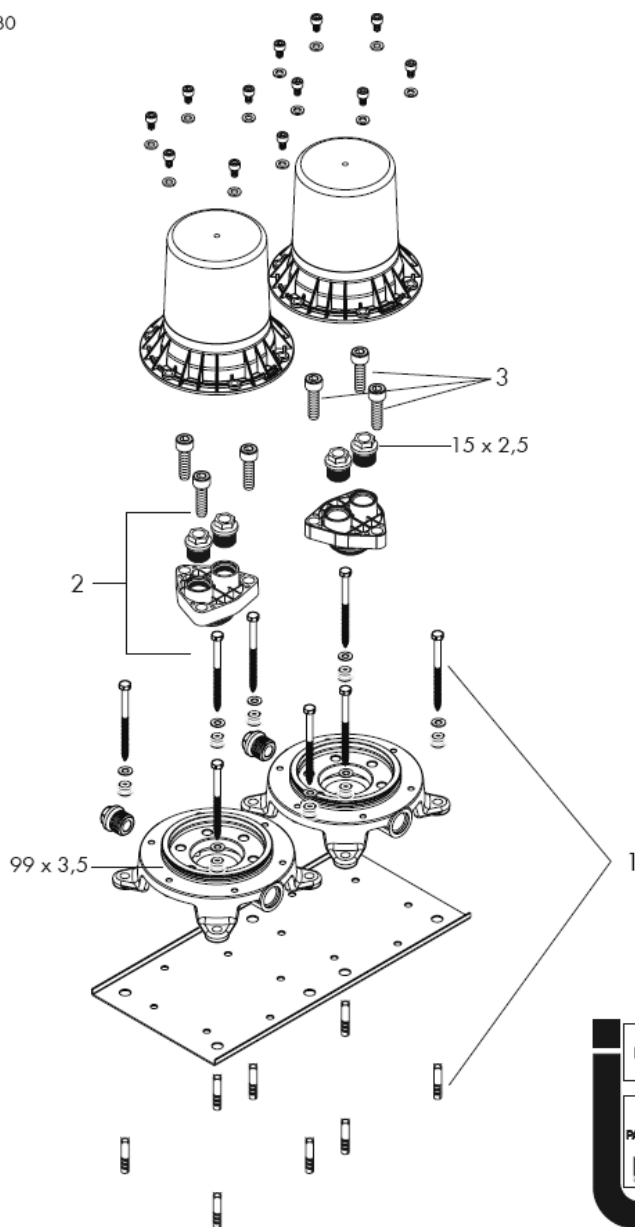

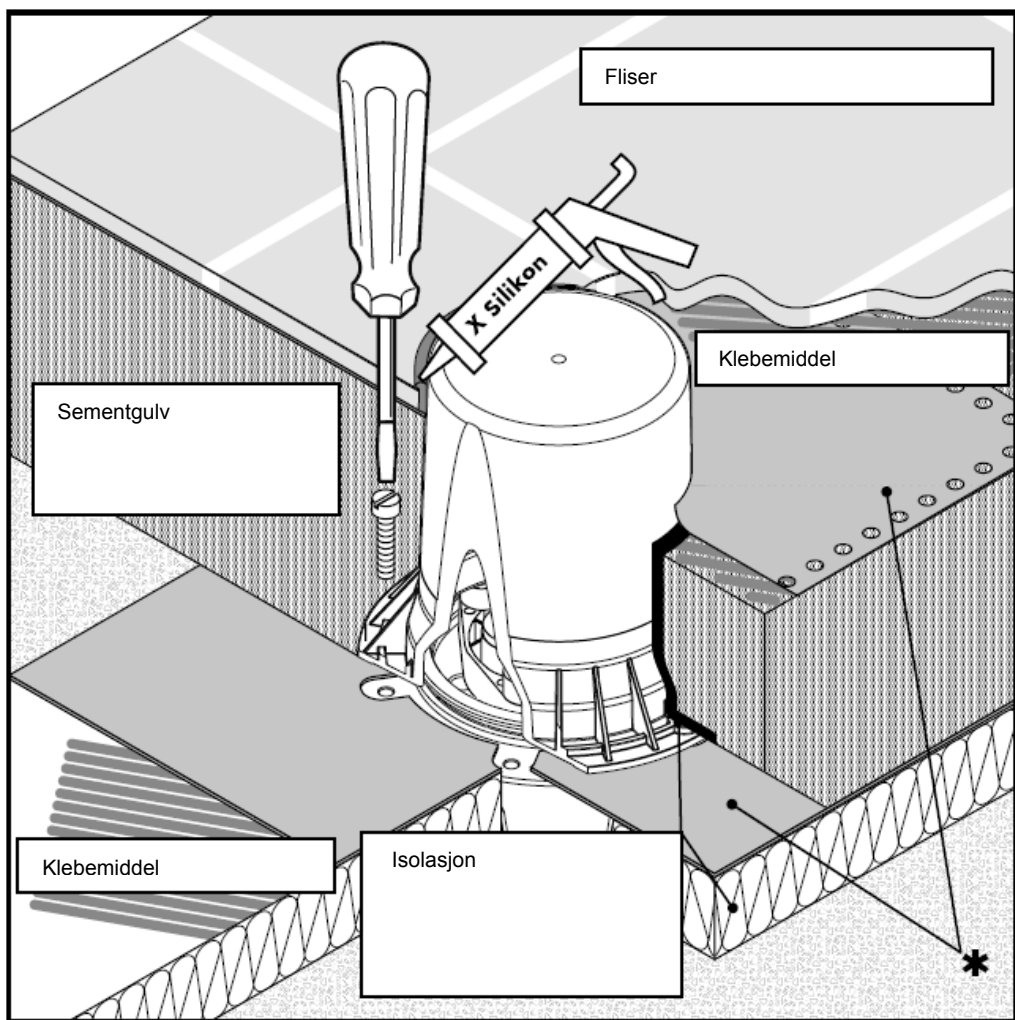

* opsjonal tilgjengelig tetningsmansjett

X Silikon (uten eddiksyre)

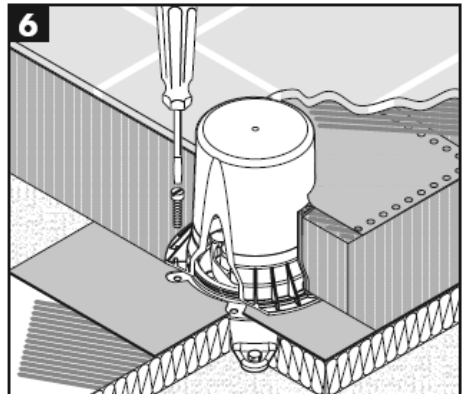
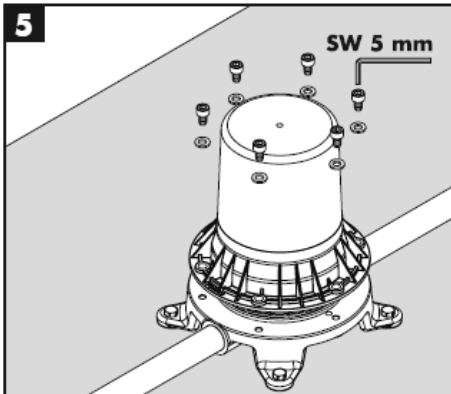
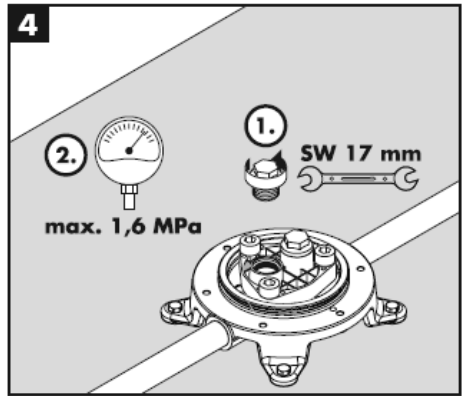
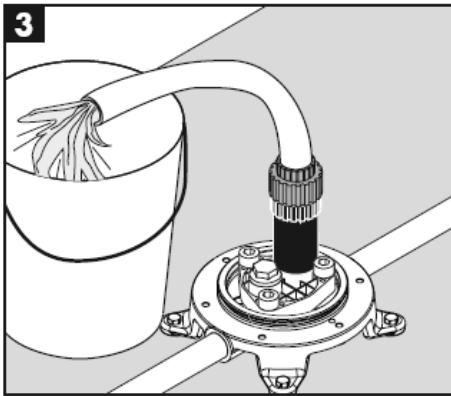
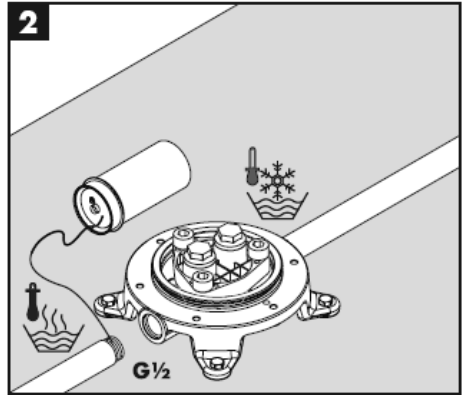
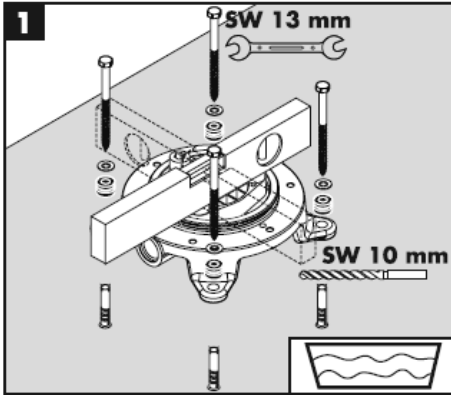

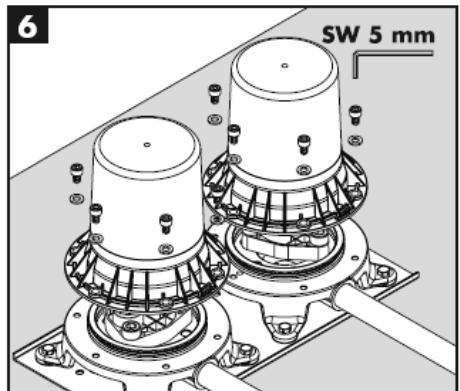
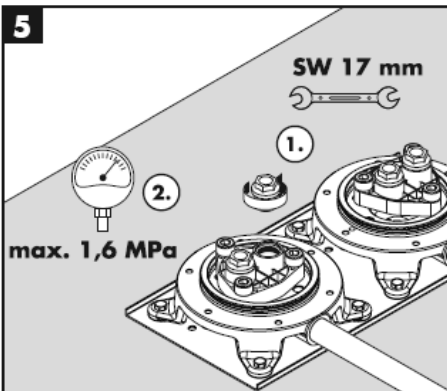
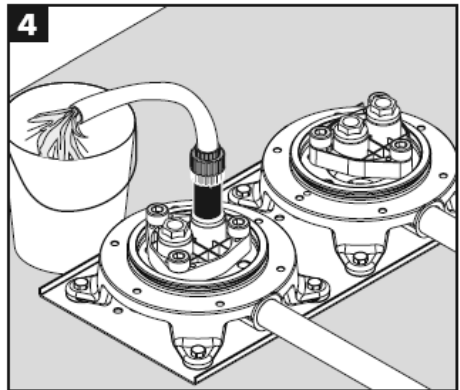
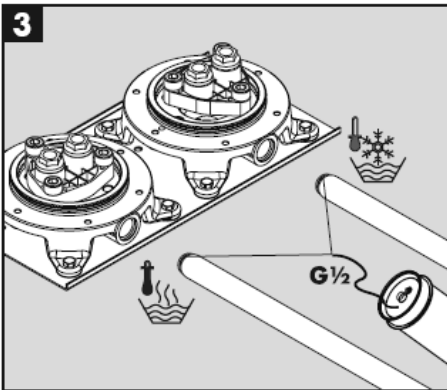
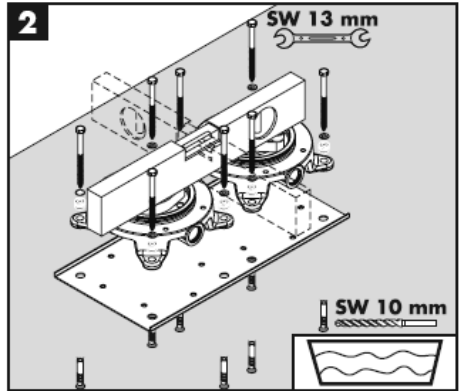
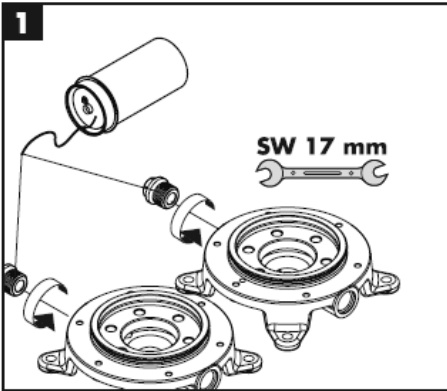

Montasje

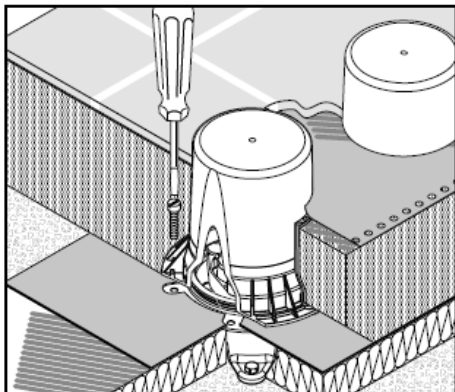

Norsk

Tekniske data

Driftstrykk	max. 1 MPa
Anbefalt driftstrykk:	0,1 – 0,5 MPa
Prøvetrykk	1,6 MPa
(1 Mpa = 10 bar = 147 PSI)	
Varmtvannstemperatur	max. 80° C
Anbefalt temperatur for varmt vann	65° C

Service­deler se side 10 – 11

Festesett	96260000
Pakningssett	96459000
Sylinderskrue M 10 x 35	97670000

Ekstratilbehør

* Tetningsmansjett (ikke med i leveransen)	96441000
---	----------

Prøve­merke

	DVGW	P-IX	SVGW	ACS	NF	WRAS	KIWA
10452180				x		X	
16549180		PA-IX 18729/ICB					

hansgrohe

РЪКОВОДСТВО ЗА МОНТАЖ

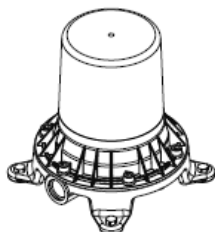

Starck
10452180

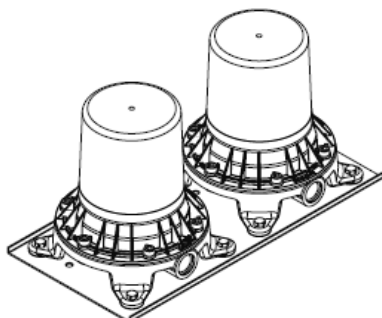

Montreux
16549180

AXOR[®]

hansgrohe

Starck 10458XXX

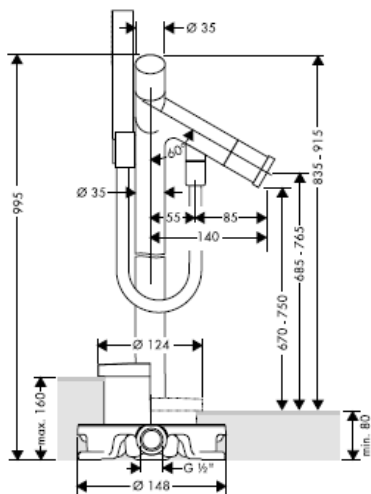

Starck 10060XXX

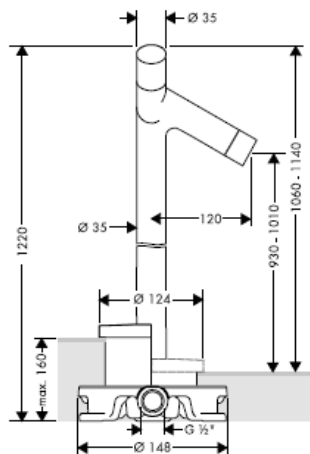

Starck 10456XXX

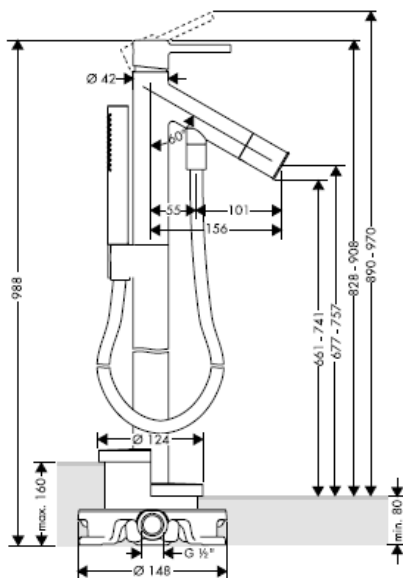

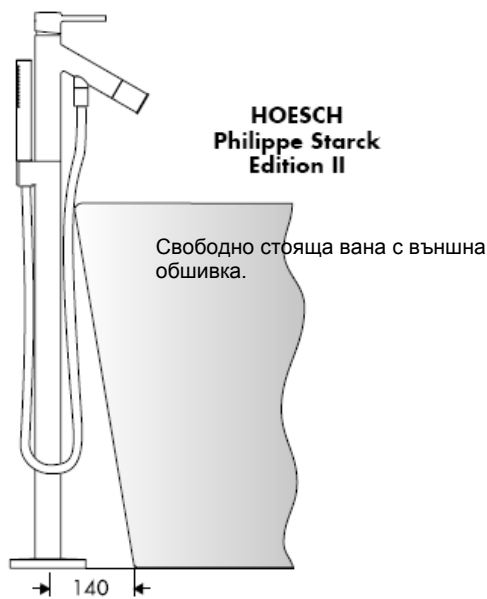
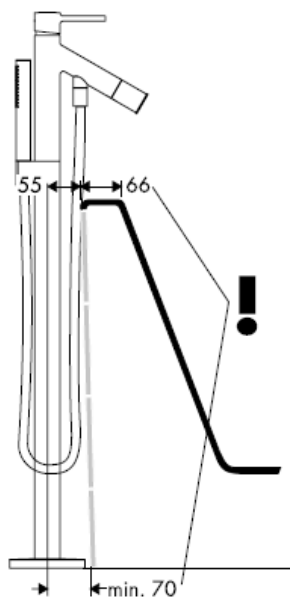
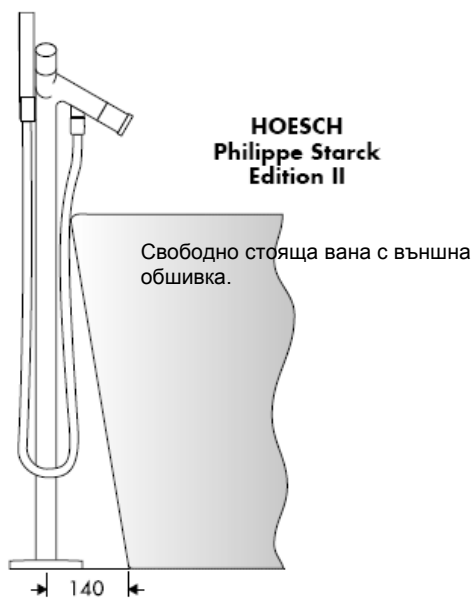

Starck X 10406000

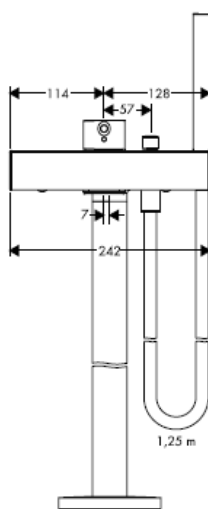
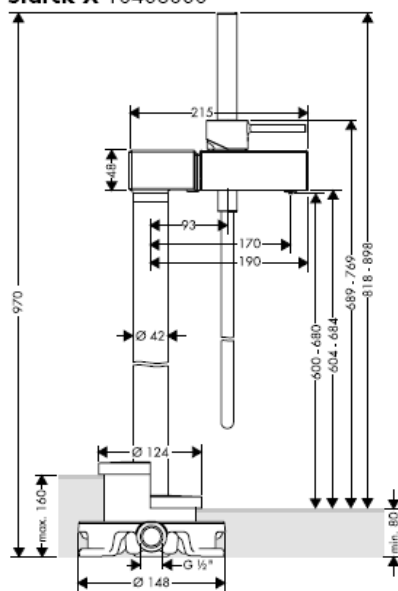

Montreux 16547XXX

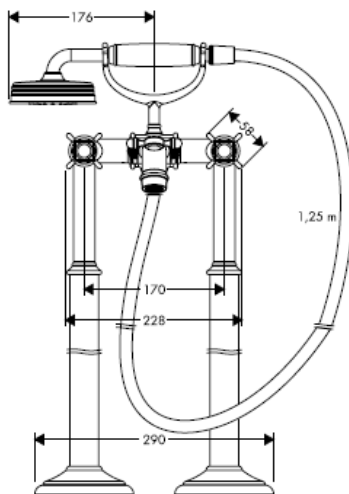
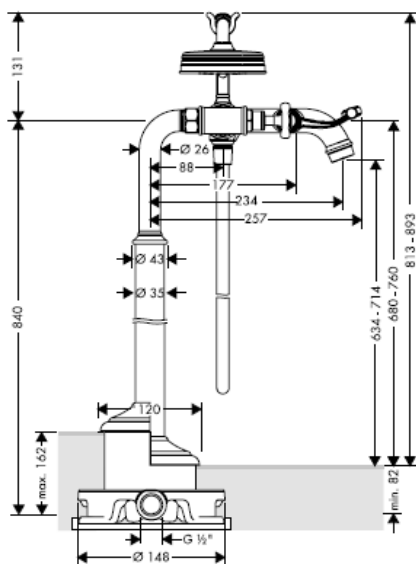

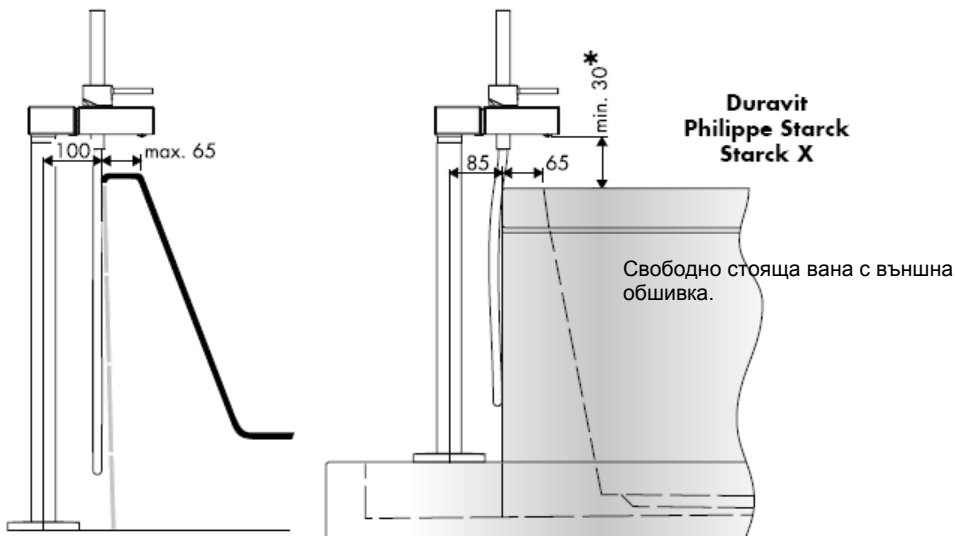

* < 30 min = Удължител 60 мм (Номенклатурен номер 97686000)



Massaud 18450000

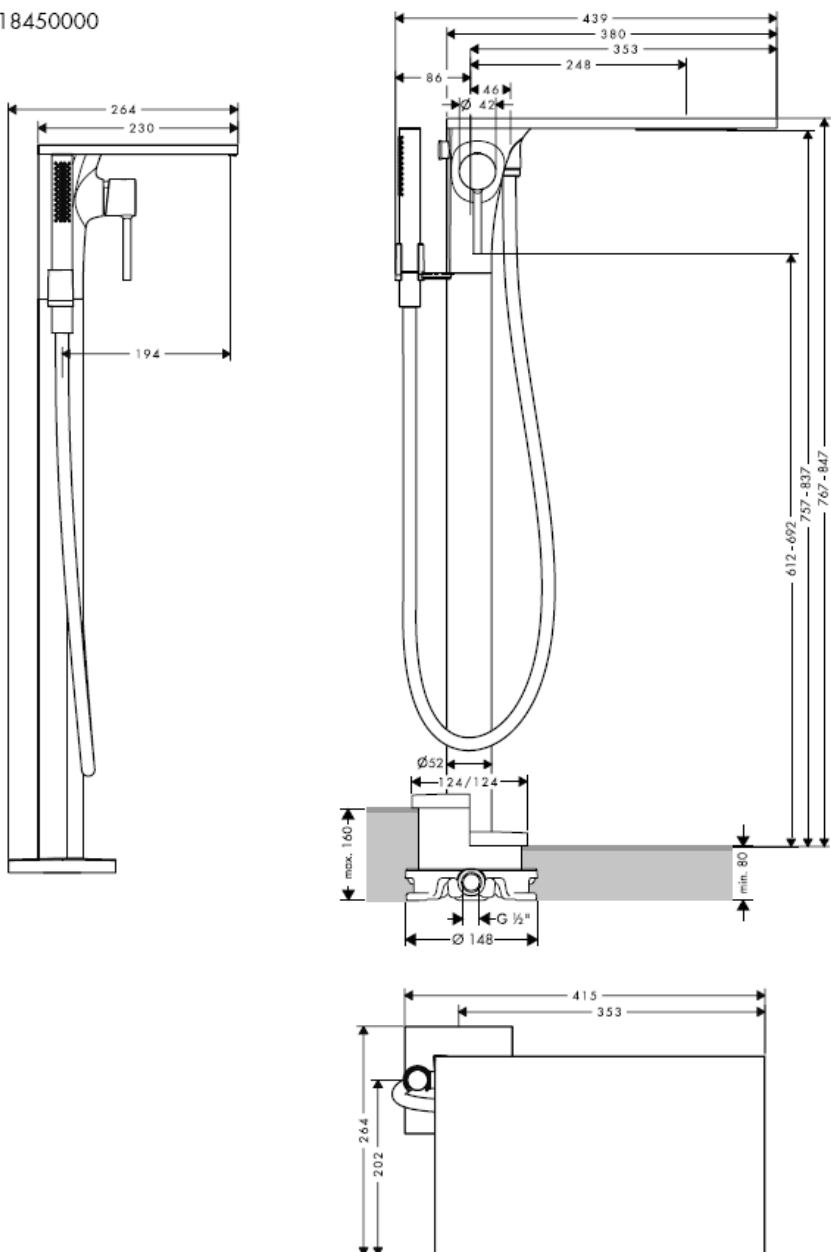

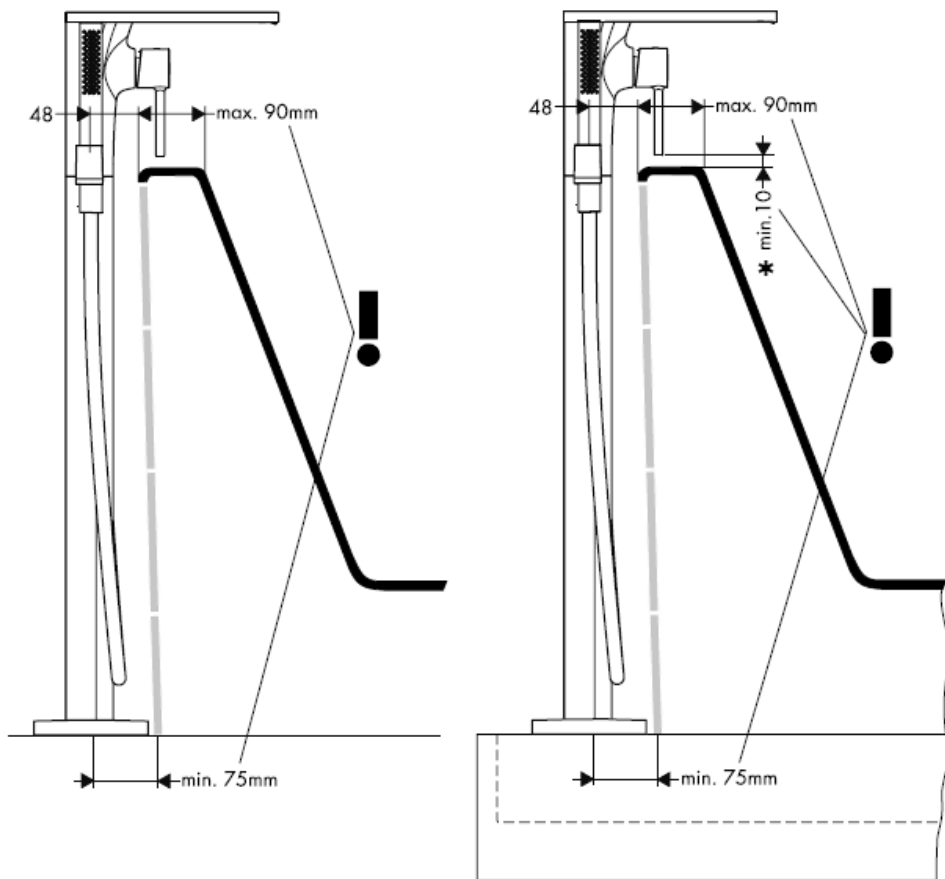

* < 10 min = Удължител 60 мм (Номенклатурен номер 97686000)

Citterio 39451000

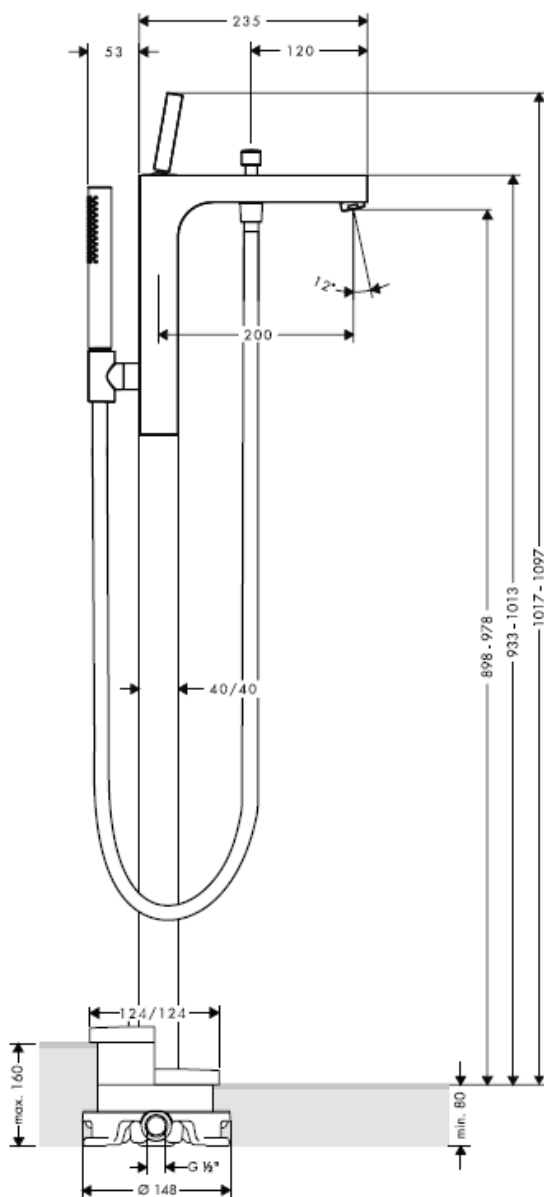

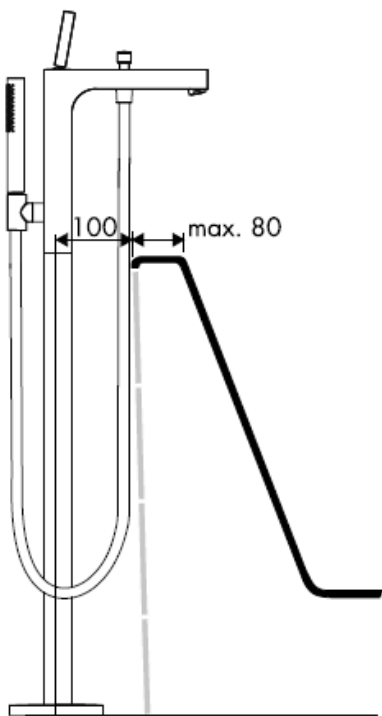

Внимание! Арматурата трябва да се монтира, промие и провери в съответствие с валидните норми!

Starck 10452180

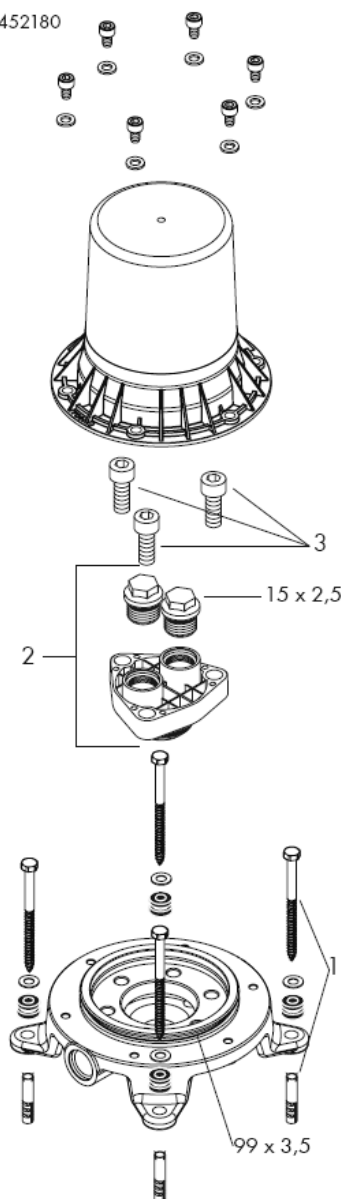

Montreux 16549180

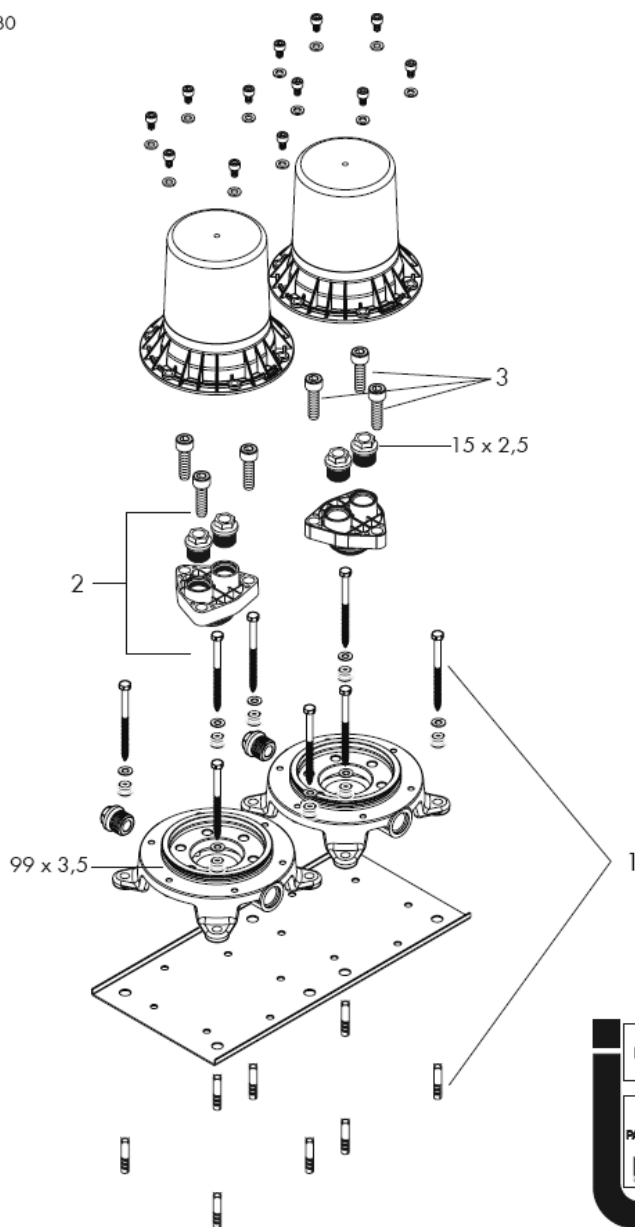

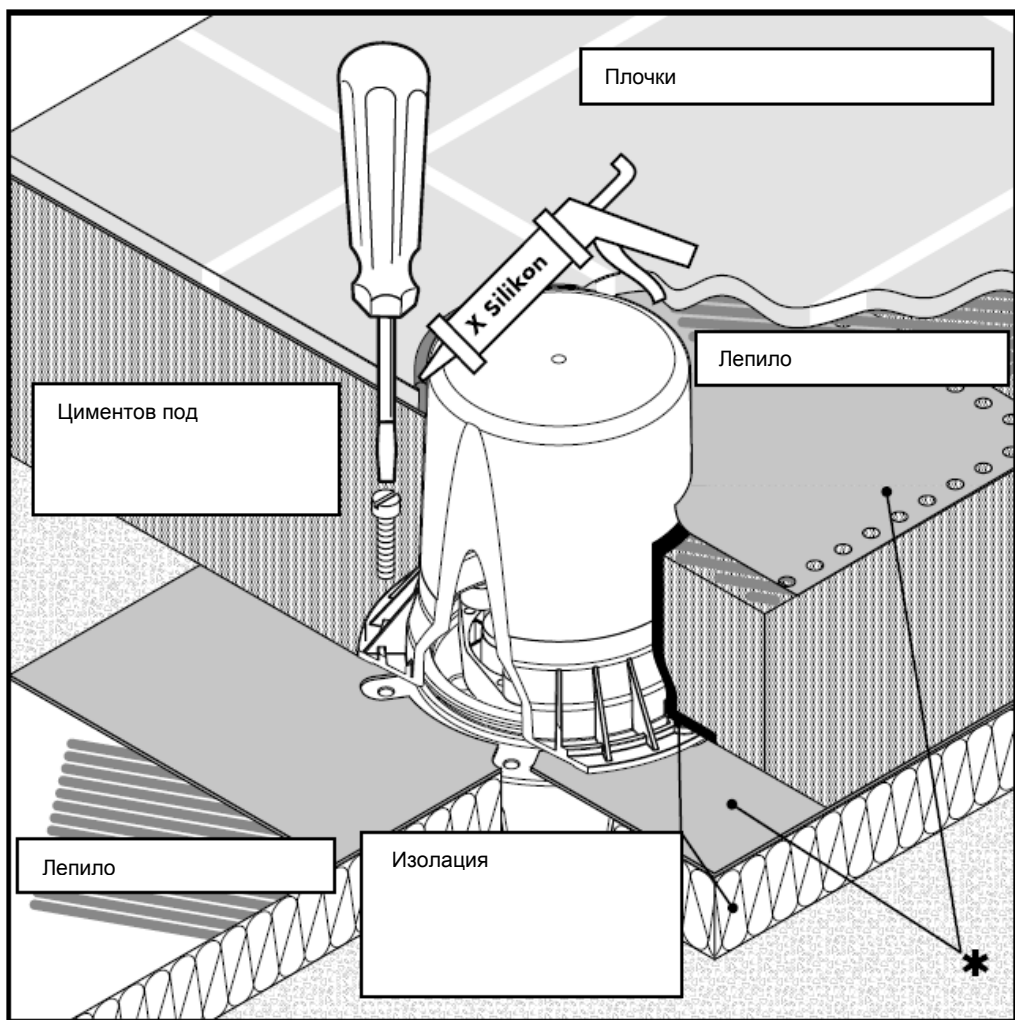

* уплътнителен маншет, който може да

X Силикон (без оцетна киселина!)

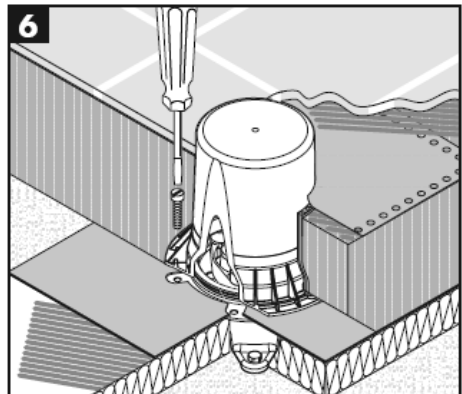
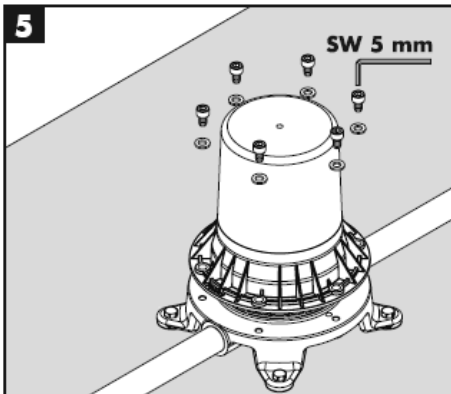
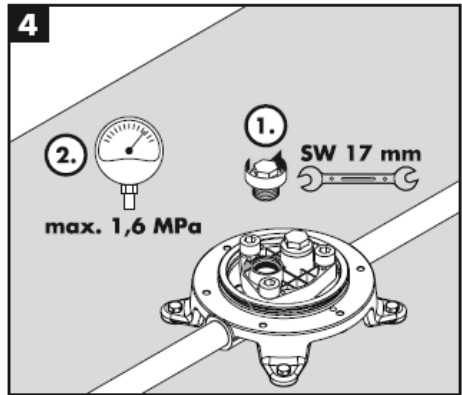
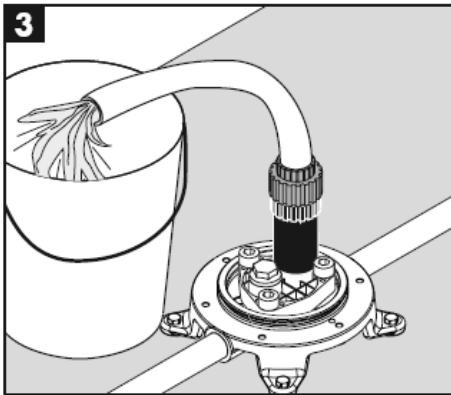
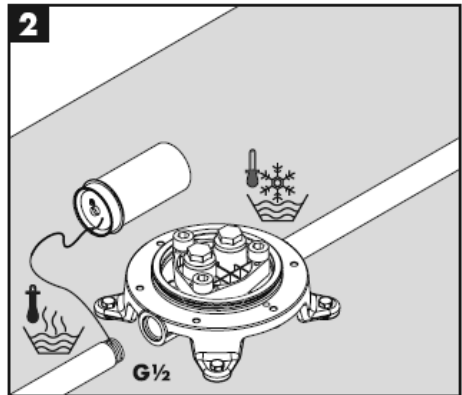
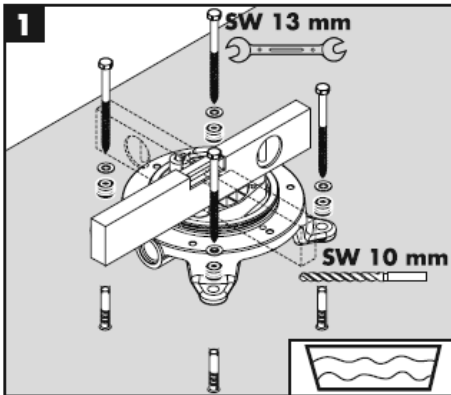

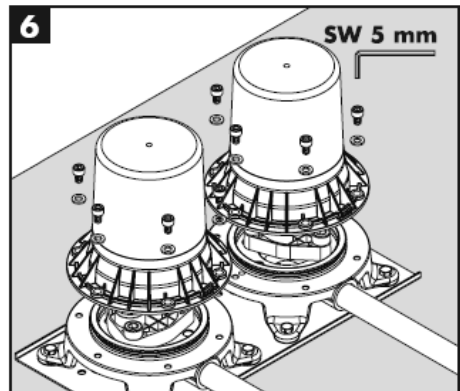
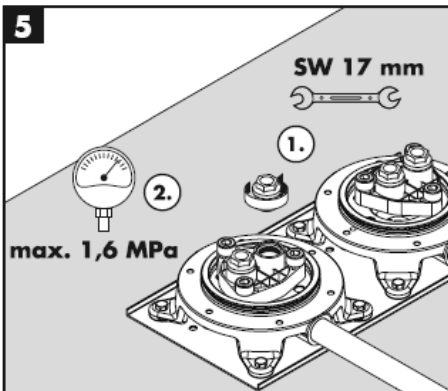
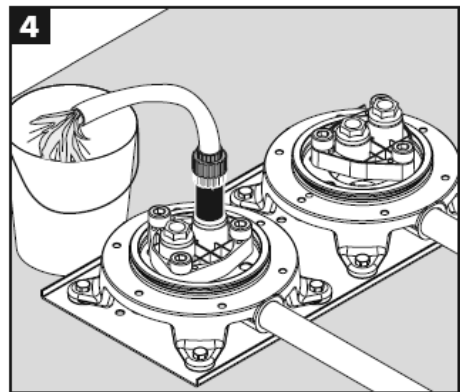
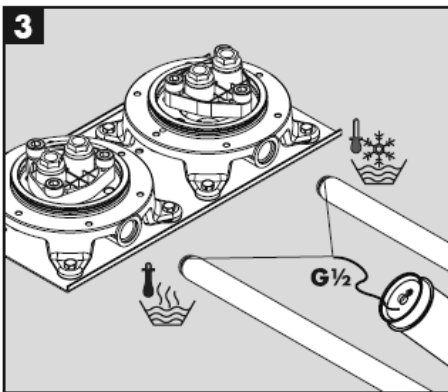
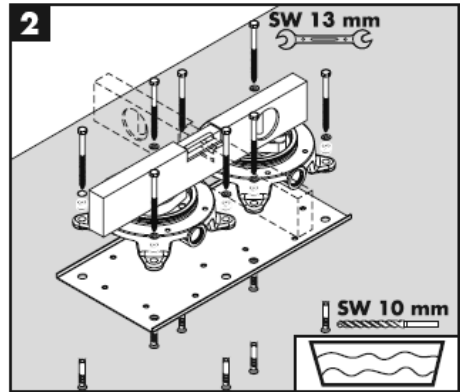
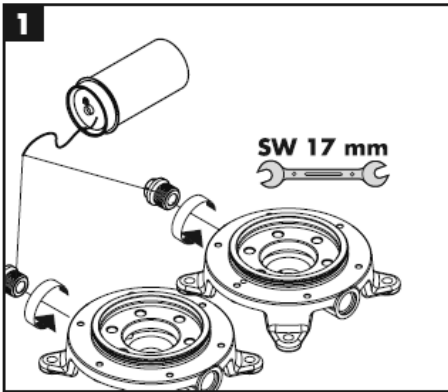

Монтаж

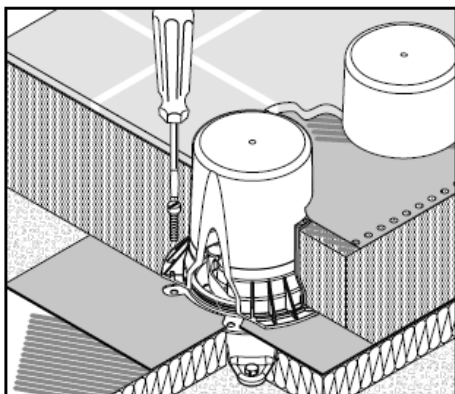

БЪЛГАРСКИ

Технически данни

Работно налягане: max. 1 МПа
Препоръчително работно налягане: 0,1 – 0,5 МПа
Контролно налягане: 1,6 МПа
(1 МПа = 10 bar = 147 PSI)
Температура на горещата вода: max. 80° C
Препоръчителна температура на горещата вода: 65° C

Контролен знак

DVGW	P-IX	SVGW	ACS	NF	WRAS	KIWA
10452180			x		X	
16549180	PA-IX 18729/ICB					

Сервизни части вижте стр. 10 – 11

Комплект за закрепване 96260000
Набор уплътнения 96459000
Болт с цилиндрична глава М 10 x 35 97670000

Специални принадлежности

* Уплътнителен маншет 96441000
(не се съдържа в обема на доставка)

hansgrohe

Udhëzime rreth montimit

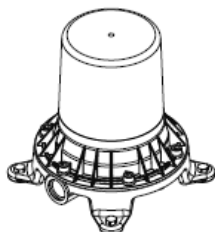

Starck
10452180

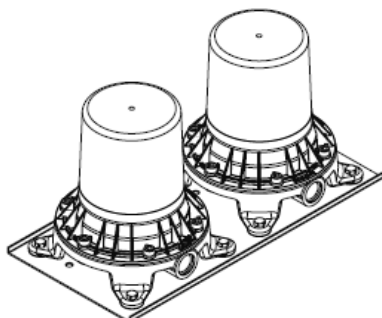

Montreux
16549180

AXOR[®]

hansgrohe

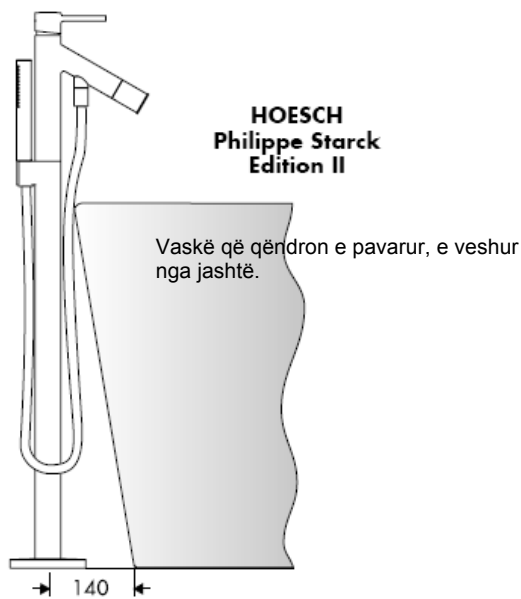
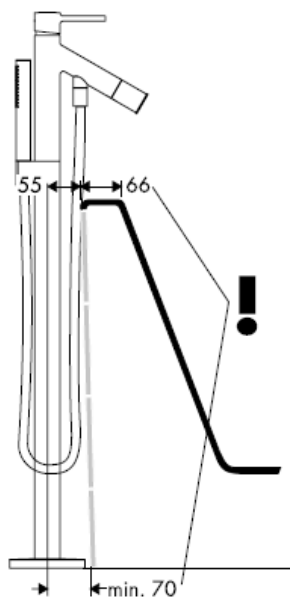
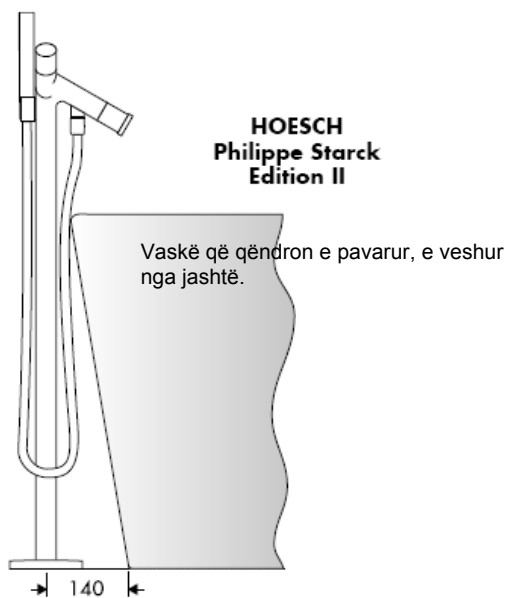

Starck X 10406000

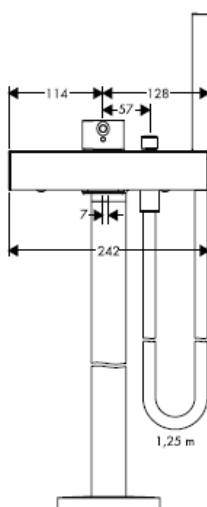
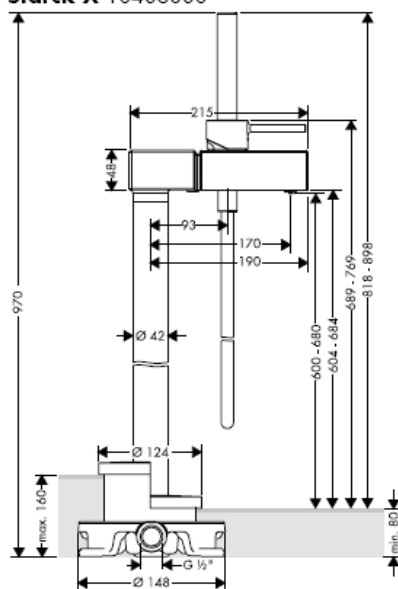

Montreux 16547XXX

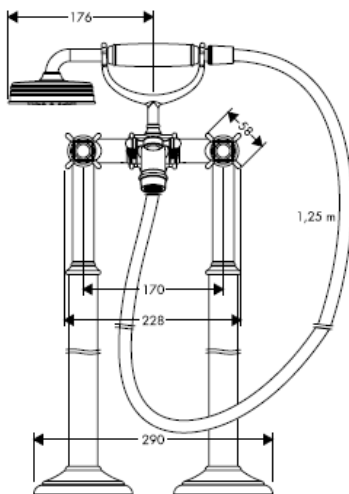
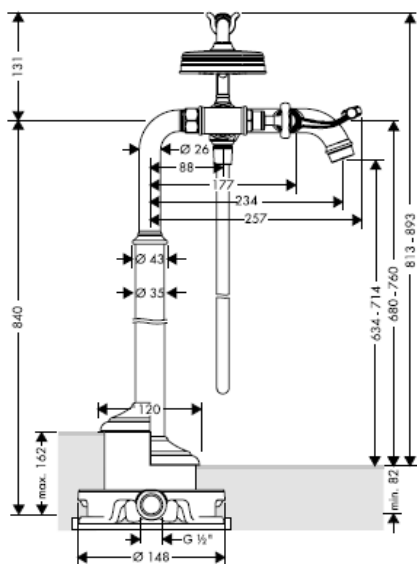

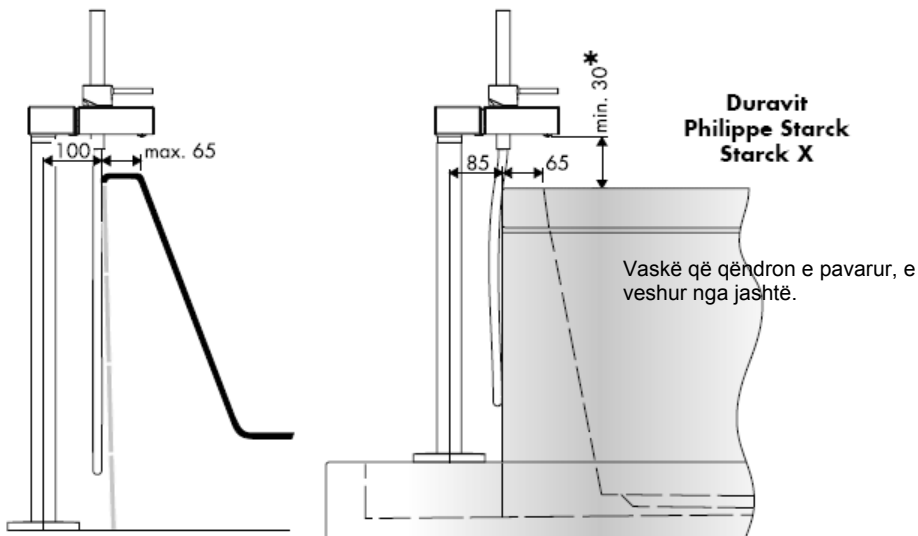

* < 30 min = Zgjatësi 60 mm (Numri i artikullit 97686000)



Massaud 18450000

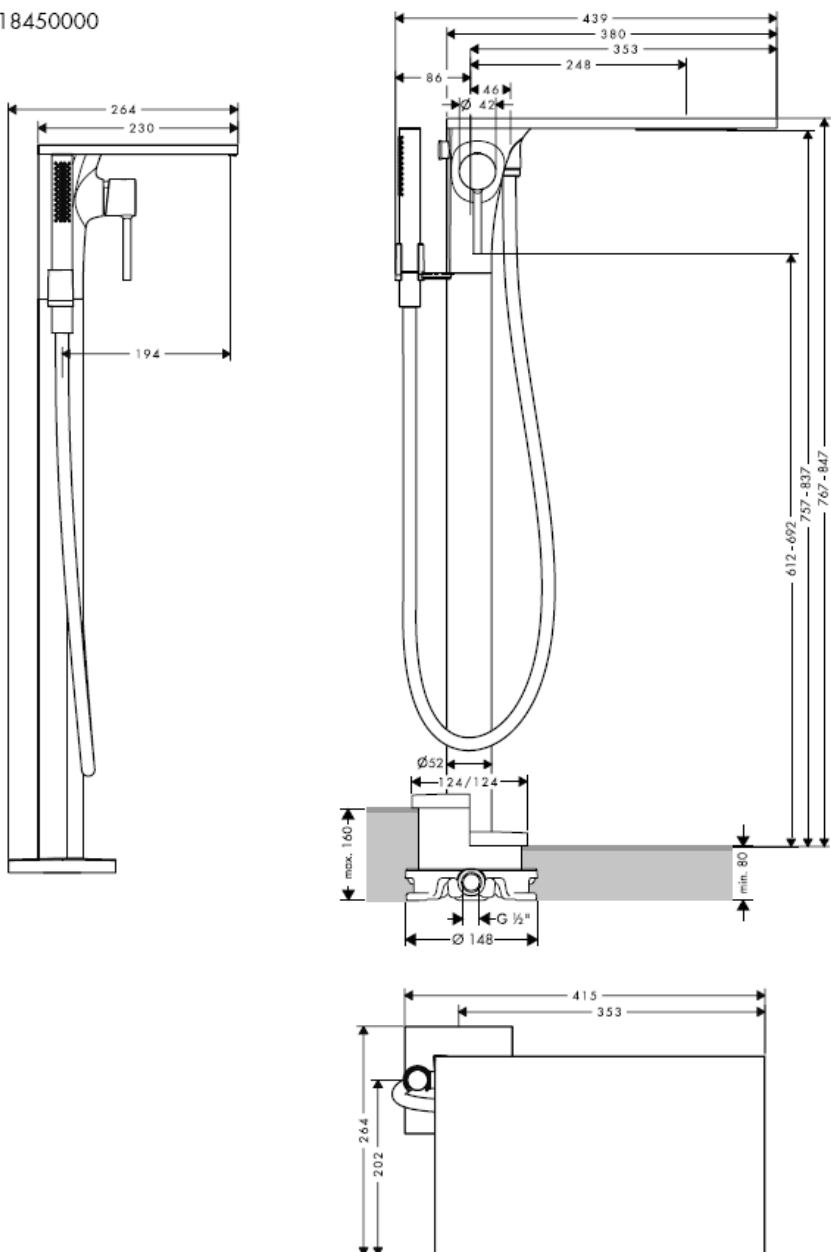

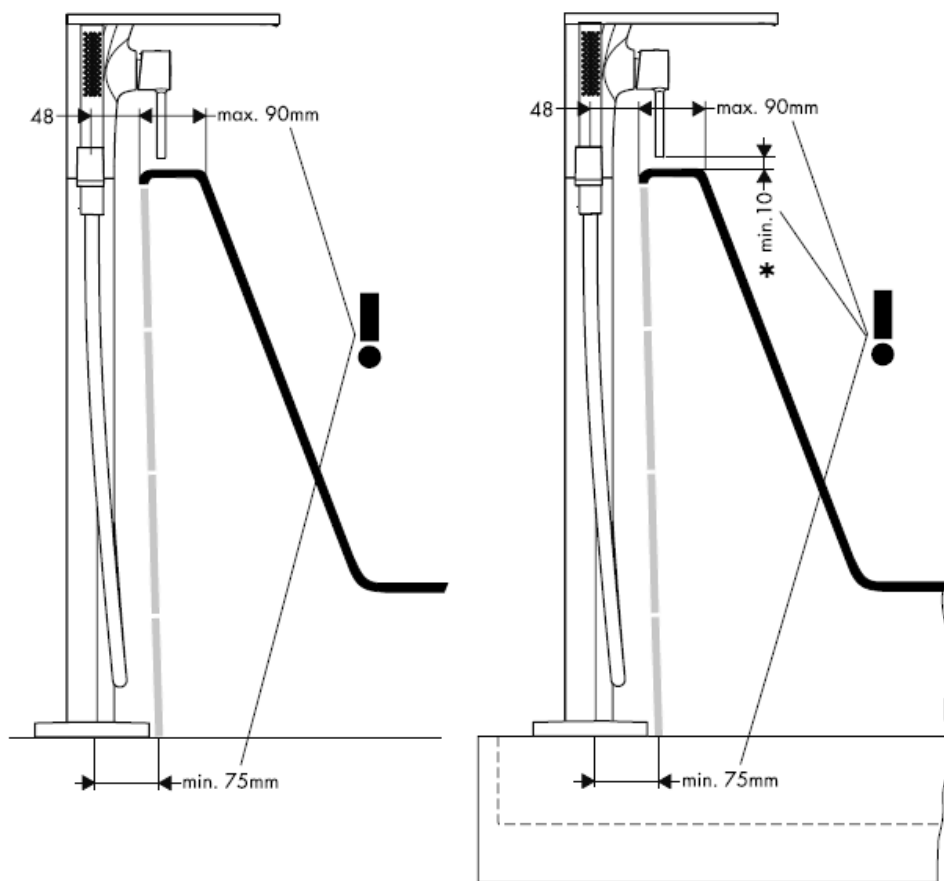

* < 10 min = Zgjatësi 60 mm (Numri i artikullit 97686000)

Citterio 39451000

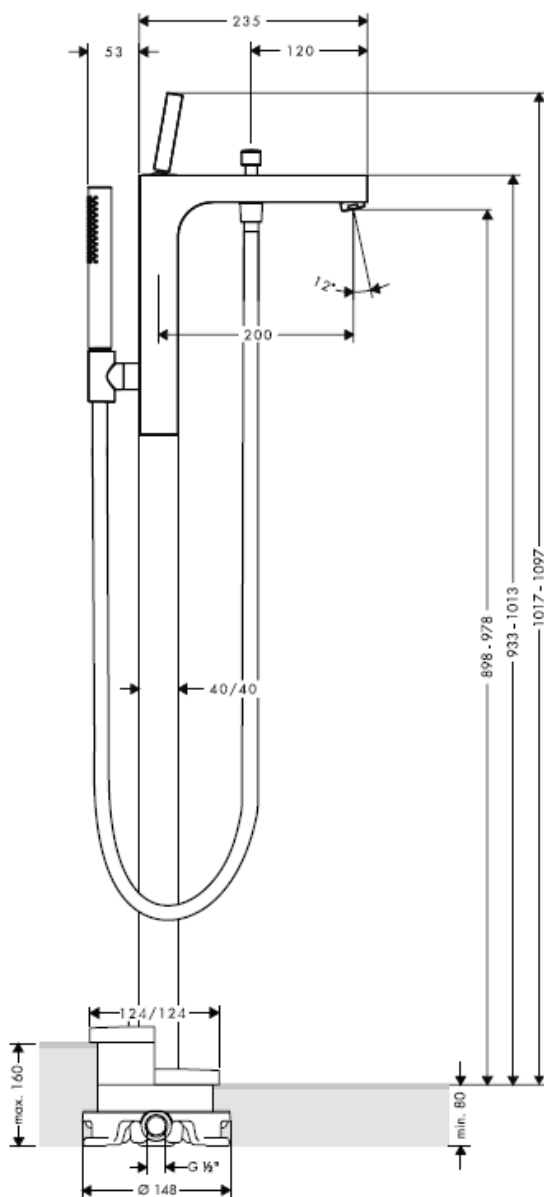

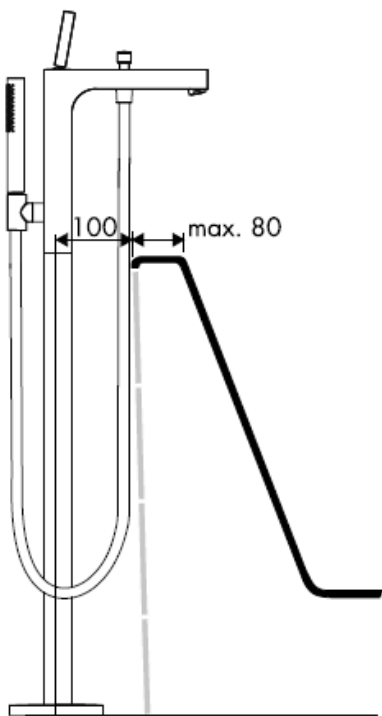

Kujdes! Armatura duhet montuar, shpërlarë dhe kontrolluar në bazë të normave të vlefshme!

Starck 10452180

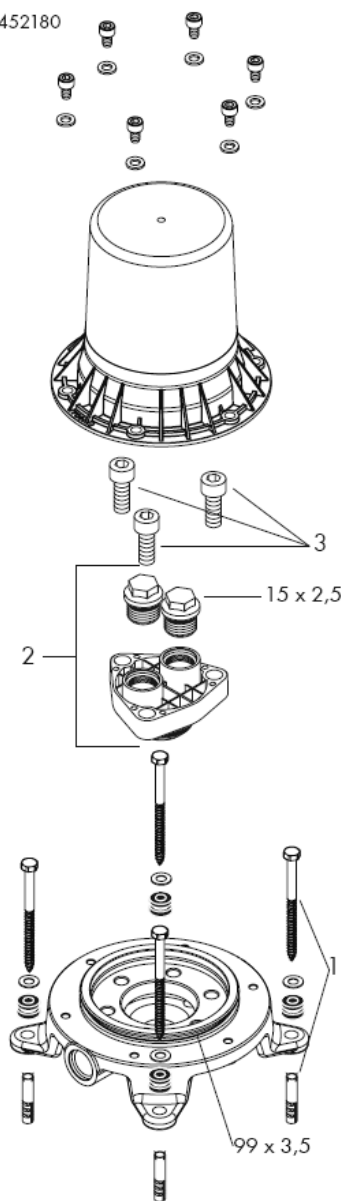

Montreux 16549180

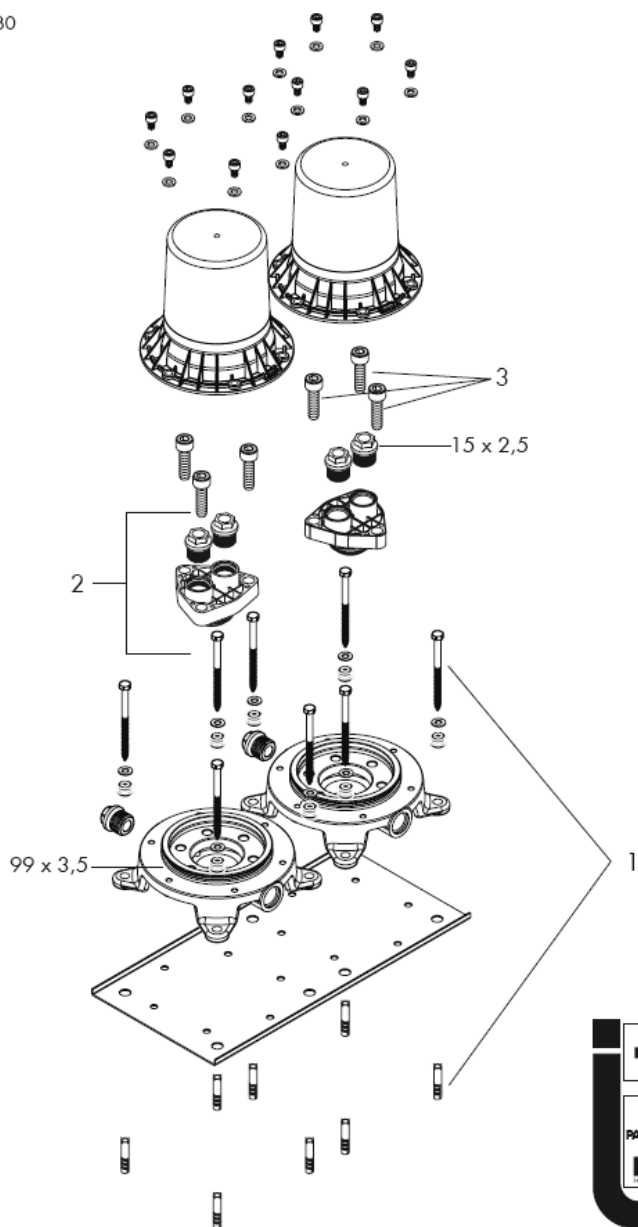

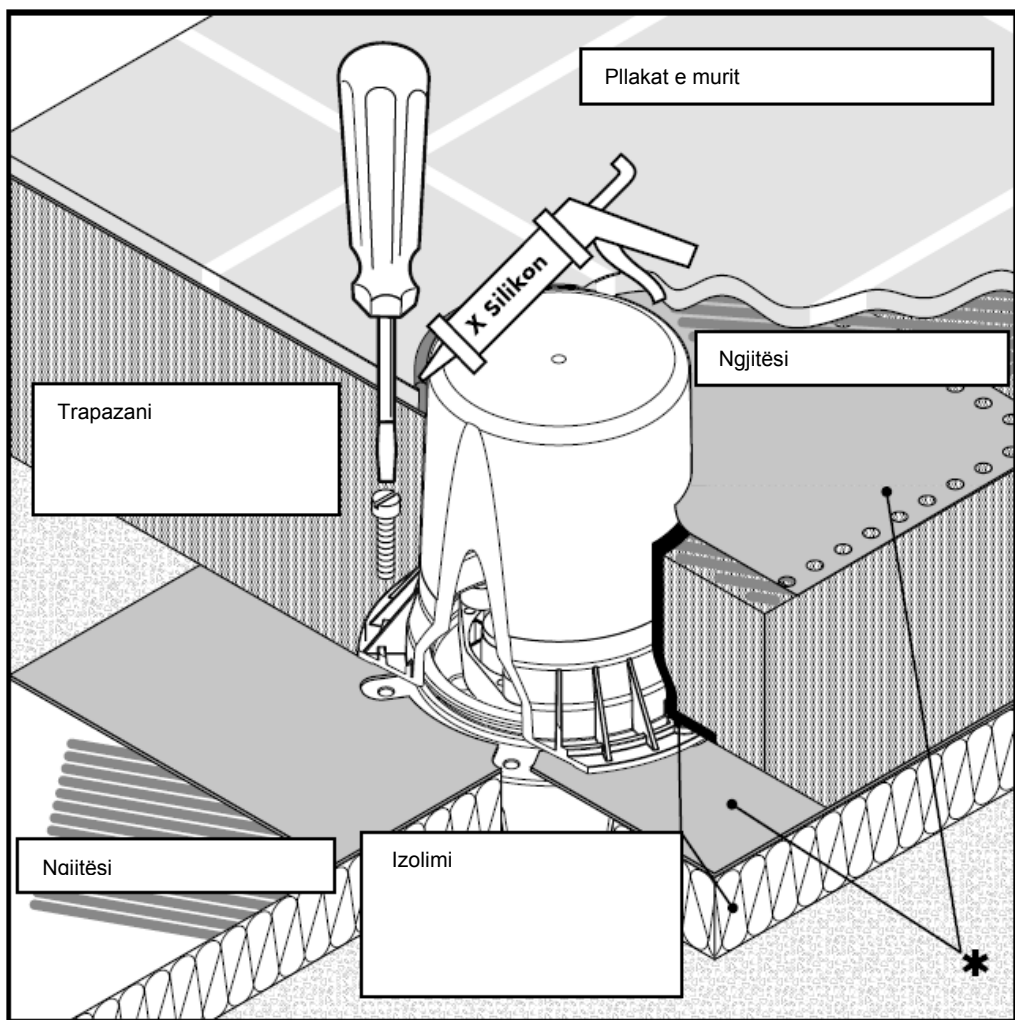

* manshetë izoluese opcionale

X Silikon (pa acid uthulle!)

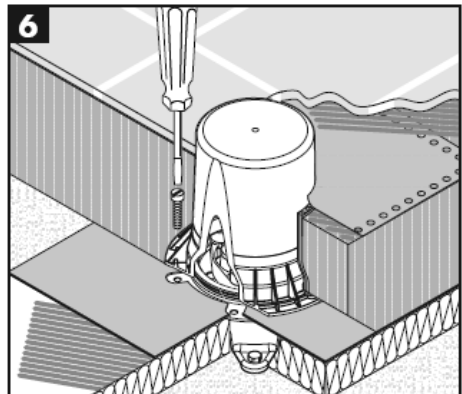
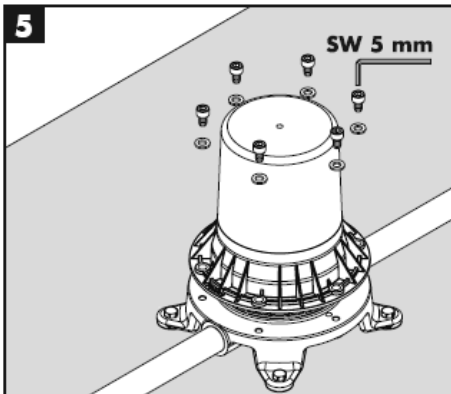
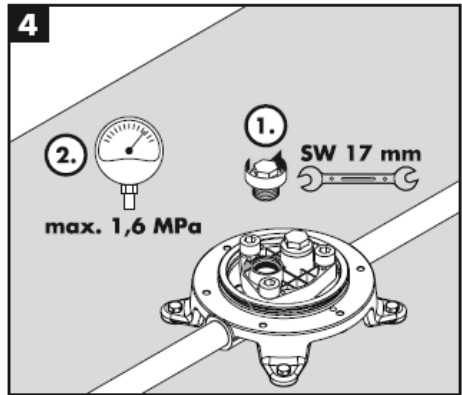
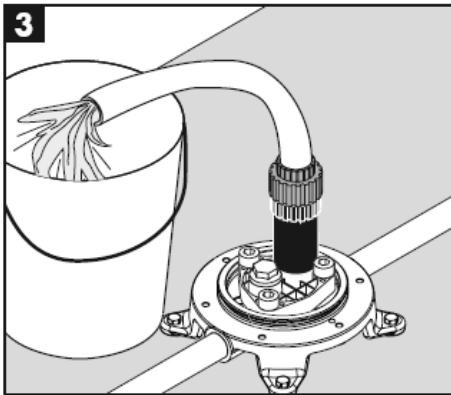
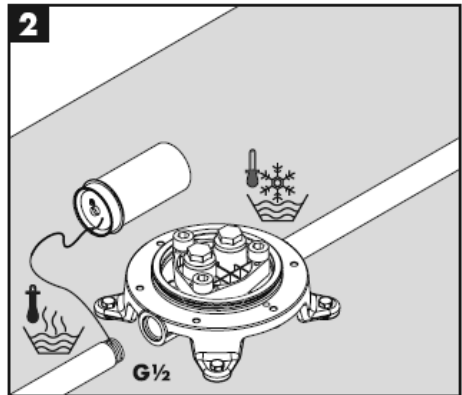
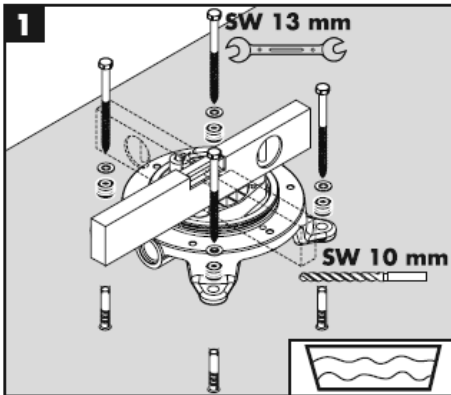

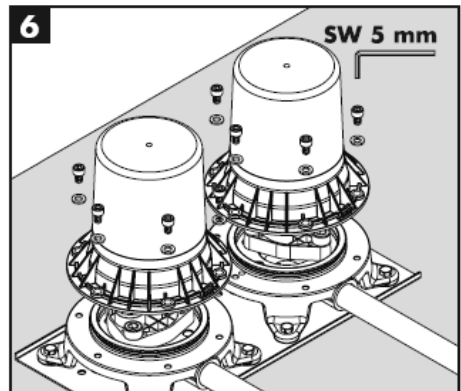
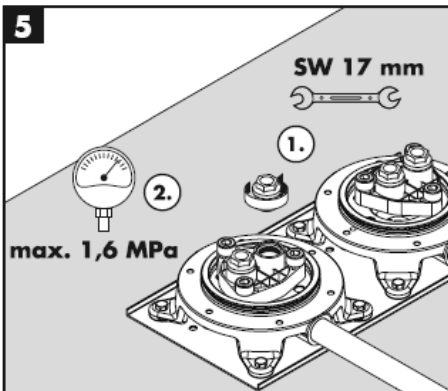
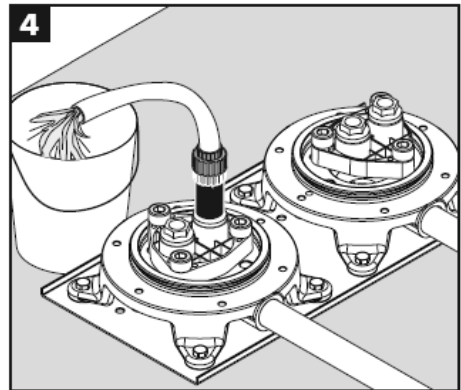
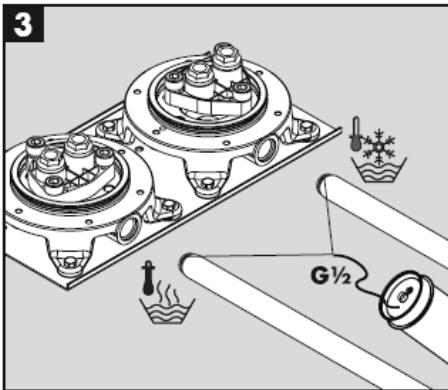
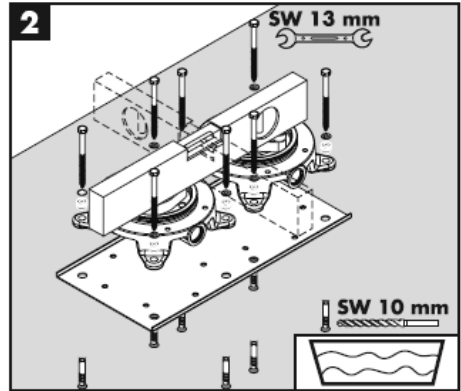
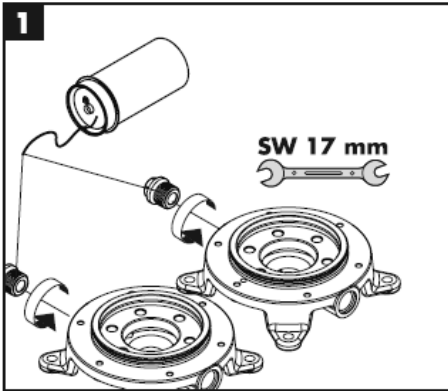

Montimi

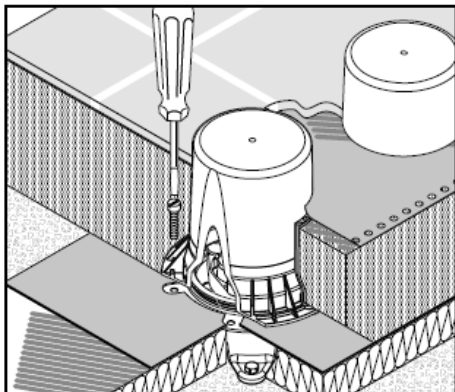

Shqip

Të dhëna teknike

Presioni gjatë punës	max. 1 MPa
Presioni i rekomanduar:	0,1 – 0,5 MPa
Presioni për provë:	1,6 MPa
(1 MPa = 10 bar = 147 PSI)	
Temperatura e ujit të ngrohtë	max. 80° C
Temperatura e rekomanduar e ujit të ngrohtë:	65° C

Pjesët e servisit shih faqen 10 – 11

Pajisja përforcuese	96260000
Kompleti i shtupës	96459000
Vidha e cilindrit M 10 x 35	97670000

Pajisje të posaçme

* Mansheta izoluese	96441000
(nuk përfshihet në vëllimin e furnizimit)	

Shenja e kontrollit

	DVGW	P-IX	SVGW	ACS	NF	WRAS	KIWA
10452180				x		X	
16549180		PA-IX 18729/ICB					

hansgrohe