

DE	Montageanleitung	2
FR	Instructions de montage	5
EN	assembly instructions	8
IT	Istruzioni per Installazione	11
ES	Instrucciones de montaje	14
NL	Handleiding	17
DK	Monteringsvejledning	20
PT	Manual de Instalação	23
PL	Instrukcja montażu	26
CS	Montážní návod	29
SK	Montážny návod	32
ZH	组装说明	35
RU	Инструкция по монтажу	38
HU	Szerelési útmutató	41
FI	Asennusohje	44
SV	Monteringsanvisning	47
LT	Montavimo instrukcijos	50
HR	Uputstva za instalaciju	53
TR	Montaj kılavuzu	56
RO	Instrucțiuni de montare	59
EL	Οδηγία συναρμολόγησης	62
SL	Navodila za montažo	65
ET	Raigaldusjuhend	68
LV	Montāžas instrukcija	71
SR	Uputstvo za montažu	74
NO	Montasjeveiledning	77
BG	Инструкция за употреба	80
SQ	Udhëzime rreth montimit	83
AR	تعليمات التجميع	86

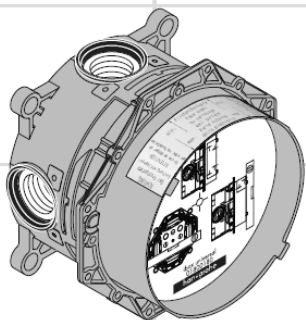

iBox universal
01800180

Rohmontage

Der rotationssymmetrische Grundkörper der iBox ist universell einsetzbar, horizontal wie vertikal. Ausgenommen bei der Montage der Wannensanitär mit Sicherungskombination, hier ist nur der vertikale Einbau möglich.

Da bei einem Defekt der Funktionsteile Wasser an der iBox austreten kann, muss die iBox über der Wanne montiert werden, damit austretendes Wasser in die Wanne abfließen kann!

Die iBox ist sowohl für Wannen- als auch für Brauseninstallation geeignet. Bei Einhand Wannenmischer ist der untere Abgang vorrangig. Bei Brauseinstallation muß der nicht benötigte Abgang mit einem Stopfen abgedichtet werden.

Grundkörper so einbauen, daß sich der Warmwasseranschluß links und der Kaltwasseranschluß rechts befindet. Einbautiefe 80 mm bis 108 mm.
Verlängerung 25 mm Artikelnummer 13595000
Verlängerung 22 mm (bei geringer Einbautiefe)
Artikelnummer 13596XXX / 13597XXX / 97407XXX / 98860000

Der Grundkörper kann entsprechend der baulichen Gegebenheiten montiert werden (Montagebeispiele siehe Seite 91 und 92).

- A** Installation auf die Wand.
- B** Installation auf die Wand. Hier mit flexiblen Abstandshalter durch 10er Stockschrauben.
- C** Montage auf Trägersystem.
- D** Installation an Fertighaus-Montageplatten oder Fertiggzellen.
- E** Installation direkt in die Wand.
- F** Installation mit Montageschienen-set 96615000.

Installationsbeispiele mit Massangaben und Leitungsdimensionierung sind ab Seite 96 zu finden.
Die Erläuterung der verwendeten Symbole auf Seite 3 und 4.

Montage-Tipp

Um Anschlussstücke einzudrehen, die iBox mittels eines Rohrstücks in den Schraubstock einspannen.

Spülen

Komplette Installation gemäß DIN 1988 / EN 1717 spülen. Die Pfeile auf dem Spülblock zeigen, welcher Zulauf mit welcher Abgangsleitung verbunden ist, z. B. Kaltwasser mit dem unteren Abgang und Warmwasser mit dem oberen Abgang. Falls nur ein Abgang benötigt wird, muß nach dem ersten Spülvorgang der Spülblock um 90° gedreht werden.

iBox in Kombination mit einer Exafill Wanneneinlauf mit Ab- und Überlaufgarnitur (siehe Seite 95)

Technische Daten

Betriebsdruck:	max. 1 MPa
Empfohlener Betriebsdruck:	0,1 - 0,5 MPa
Prüfdruck:	1,6 MPa
(1 MPa = 10 bar = 147 PSI)	
Heißwassertemperatur:	max. 80 °C
Empfohlene Heißwassertemperatur:	65 °C
Anschlussmaße:	G 3/4"
Anschlüsse:	kalt rechts - warm links
Freier Durchfluss bei 0,3 MPa:	
Wannenmischer Abgang Wanne:	31 l/min
Wannenmischer Abgang Brause:	24 l/min
Brausemischer:	32 l/min
Thermostat:	43 l/min
Thermostat mit Absperrventil / Brausenthermostat mit elektronischer Start-Stop-Taste:	26 l/min
Thermostat mit Absperr- und Umstellventil:	26 l/min
Thermostat High Flow:	58 l/min
iControl:	30 l/min
iControl mobile:	37 l/min



Thermostat (siehe Seite 118, 120, 126)



High Flow

Thermostat High Flow (siehe Seite 128 - 146)



Thermostat mit Absperrventil (siehe Seite 102, 104, 106, 112, 122)

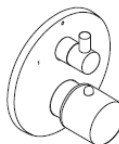

Thermostat mit Absperr- und Umstellventil (siehe Seite 98, 114, 116, 124)



Brausenthermostat mit elektronischer Start-Stop-Taste (siehe Seite 112)

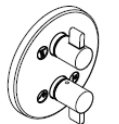

iControl Absperr- und Umstellventil (siehe Seite 144)



iControl mobile Absperr- und Umstellventil (siehe Seite 146)

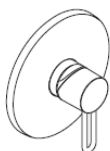

Brausemischer (siehe Seite 102, 104, 106, 112, 122)



Wannenmischer (siehe Seite 98, 100, 114, 116)



DVGW

Wannenmischer mit integrierter Sicherungskombination (siehe Seite 96)

An der Sicherungskombination kann bei einem Defekt Wasser austreten!

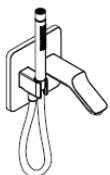

Wanneneinlauf (siehe Seite 100)

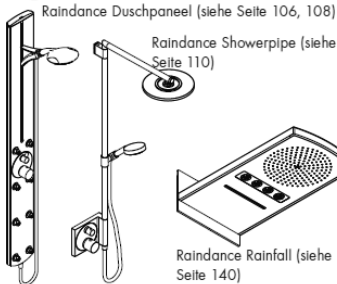





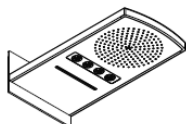









Raindance Duschanneel (siehe Seite 106, 108)

Raindance Showerpipe (siehe Seite 110)



Raindance Rainfall (siehe Seite 140)

<p>X</p>	<p>Mitte Badewanne / Mitte Duschwanne</p>		<p>Unterputz-Ventil</p>
<p>Y</p>	<p>Maß Y = Mitte Schlauchanschlussbogen bis Mitte Wanneneinlauf dividiert durch 2 (eventuell dem Fliesenraster anpassen).</p>	 <p>Quattro</p>	<p>Quattro Vierwegeumstellung</p>
	<p>Warmwasser</p>	 <p>T r i o</p>	<p>Trio Universal Absperr- und Umstellventil</p>
	<p>Kaltwasser</p>		<p>Wanneneinlauf</p>
	<p>Ab • ist die Funktion gewährleistet.</p>		<p>Der nicht benötigte Abgang muss mit einem Blindstopfen abgedichtet werden. (DN 20 3/4")</p>
	<p>In diesem Bereich ist eine Wandverstärkung notwendig.</p>		<p>Die Abflueistung muss mehr als 50 l/min betragen.</p>
	<p>Nur ein Verbraucher möglich, nicht zwei gleichzeitig.</p>	 <p>Raindrain</p>	<p>Ablauf</p>
	<p>Wasserleitungen für Seitenbrausen mit Gefälle verlegen.</p>	 <p>Exafill</p>	<p>iBox in Kombination mit einer Exafill Wanneneinlauf mit Ab- und Überlaufgarnitur (siehe Seite 95)</p>

Montage de base

La pièce de base rotative symétrique de l'iBox a une possibilité de montage universel, horizontal comme vertical. Sauf pour le montage d'un mitigeur bain-douche avec disconnecteur ou là le montage vertical seulement est possible.

Parce que l'eau pourrait fuir de l'iBox en cas de défaillance des pièces de fonctionnement, l'iBox doit être monté au dessus de la baignoire pour que la fuite puisse s'écouler dans la baignoire.

L'iBox est appropriée aussi bien pour les baignoires que pour les douches. Pour un mitigeur douche, la sortie inférieure est prioritaire. Pour une installation de douche, la sortie non utilisée doit être condamnée avec un bouchon.

Monter la pièce de base pour que l'eau chaude arrive sur le côté gauche et l'eau froide sur le côté droit.

Profondeur d'encastrement: 80 mm à 108 mm.

jeu de rallonge 25 mm référence 13595000

Rallonge de 22 mm (pour profondeur de montage trop faible) référence 13596XXX / 13597XXX / 97407XXX/ 98860000

La pièce de base peut être installée selon les différentes (possibilités voir pages 91 et 92).

- A** Installation au mur.
- B** Installation au mur avec une vis de distance.
- C** Montage sur système support.
- D** Installation encastree sur plaques de montage d'un préfabriqué ou sur cellules préparées.
- E** Installation directement dans le mur.
- F** Installation avec rail de fixation 96615000.

Des exemples d'installation avec indication de cotes et dimensions des conduites sont fournis à partir de la page 96.

Les symboles utilisés sont expliqués à la page 6 et 7.

Exemple de montage

Pour monter les différents raccords, on peut fixer l'iBox grâce à un tuyau et un étai.

Rinçage

Rincer l'installation complète conformément à la réglementation et aux normes.

Les flèches sur le bloc de rinçage indiquent l'arrivée et la sortie qui doivent être raccordés, par exemple eau froide avec sortie 1 et eau chaude avec sortie 2. Si on utilise seulement une sortie, on devra après le premier rinçage tourner de 90° le bloc de rinçage.

iBox en combinaison avec un remplissage exa-fill avec mécanisme de vidage et de trop plein (voir page 95)

Informations techniques

Pression de service autorisée:	max. 1 MPa
Pression de service conseillée:	0,1 - 0,5 MPa
Pression maximum de contrôle:	1,6 MPa
(1 MPa = 10 bar = 147 PSI)	
Température d'eau chaude:	max. 80 °C
Température recommandée:	65 °C
Dimension d'arrivée:	G 3/4"
Raccordement: froide à droite chaude à gauche entr'axe	
Débit libre à 0,3 MPa:	
Mitigeur bains-douches Sortie baignoire:	31 l/min
Mitigeur bains-douches Sortie douche:	24 l/min
Mitigeur douche:	32 l/min
Mitigeur thermostatique:	43 l/min
Mitigeur thermostatique avec robinet d'arrêt / Mitigeur thermostatique électronique avec touche Marche / arrêt:	26 l/min
Mitigeur thermostatique avec robinet d'arrêt et inverseur:	26 l/min
Mitigeur thermostatique High Flow:	58 l/min
iControl:	30 l/min
iControl mobile:	37 l/min



Mitigeur thermostatique (voir pages 118, 120, 126)



High Flow

Mitigeur thermostatique High Flow (voir pages 128 - 146)

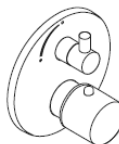

Mitigeur thermostatique avec robinet d'arrêt (voir pages 102, 104, 106, 112, 122)

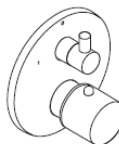

Mitigeur thermostatique avec robinet d'arrêt et inverseur (voir pages 98, 114, 116, 124)



Mitigeur thermostatique électronique avec touche Marche / arrêt (voir pages 112)

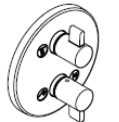

iControl
Robinet d'arrêt et inverseur (voir pages 144)



iControl mobile
Robinet d'arrêt et inverseur (voir pages 146)

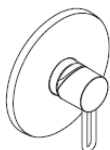

Mitigeur douche (voir pages 102, 104, 106, 112, 122)



Mitigeur bains-douches (voir pages 98, 100, 114, 116)



DVGW

Mitigeur bains-douches avec disconnecteur (voir pages 96)

En cas de défaillance, de l'eau peut ressortir au niveau de la combinaison de sécurité

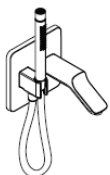

Bec déverseur (voir pages 100)

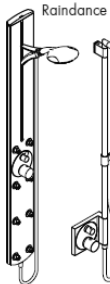





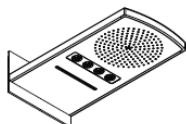









Raindance Duschpaneel (voir pages 106, 108)

Raindance Showerpipe (voir pages 110)



Raindance Rainfall (voir pages 140)

- X** Centre de la baignoire / Centre cuvette de douche  Robinet d'arrêt encastré
- Y** Dimension Y = du centre raccord coudé de douche au centre bec déverseur divisé par 2 (éventuellement s'adapter au carrelage).  Quattro inverseur quatre voies
-  Eau chaude  Trio Robinet d'arrêt avec inverseur
-  Eau froide  Bec déverseur
-  A partir de • le fonctionnement est garanti.  La sortie non utilisée doit être condamnée avec un bouchon laiton. (DN 20 3/4")
-  Le mur n'a pas besoin d'être renforcé à cet endroit  Le débit de vidage doit être supérieur à 50 l/min.
-  Une seule utilisation possible, pas les deux ensemble.  Raindrain Vidage
-  La tuyauterie des douchettes latérales à installer avec une pente.  Exafill iBox en combinaison avec un remplissage exafill avec mécanisme de vidage et de troplein (voir page 95)

Concealed installation

The rotation symmetrical body is horizontal and vertical usable. Only exception installing the bath-shower mixer with integrated safety combination. In this case only a vertical installation is possible.

Install the iBox always above the bath-tub. If parts of the iBox will broken, the water can flow in there!

The iBox is suitable for both bath and shower applications. When using the bath-shower mixer outlet, the lower outlet must have priority. For shower applications, plug the unused outlet with a plug.

Install body with the hot water supply left and cold water supply right.
Depth of fitting: 80 mm to 108 mm.
extension 25 mm article number 13595000
Extension Set 22 mm (when wall is not deep enough).
article number 13596XXX / 13597XXX / 97407XXX / 98860000

The iBox can depending on the building application be mounted in different ways, Installation examples please see page 91 and 92.

- A** Direct wall installation.
- B** Direct wall installation with 10 mm adjustable mounting studs.
- C** Installation on carrier system.
- D** Installation on prefabricated house installation panels or finished cells.
- E** Brick wall installation.
- F** Installation with fixation set 96615000.

Installation examples with measurements and pipe dimensions can be found starting on page 96.
The used symbols are explained on pages 9 and 10.

Installation tip

To install the supply pipes, fix the iBox with a pipe in a vice.

Flush piping system

Flush the entire system as per DIN 1988 / EN 1717. The arrows on the flush body show which inlet is connected with which outlet, for example cold water supply with the bottom outlet and hot water supply with the top outlet. If only one outlet is in use, after first flushing the flush body must be rotated by 90°.

iBox in combination with an Exafill bath filler with overflow and waste (see page 95)

Technical Data

Operating pressure:	max. 1 MPa
Recommended operating pressure:	0,1 - 0,5 MPa
Test pressure:	1,6 MPa
(1 MPa = 10 bar = 147 PSI)	
Hot water temperature:	max. 80 °C
Recommended hot water temp.:	65 °C
Centre distance:	G 3/4"
Connections:	cold right - hot left
Rate of flow by 0,3 MPa:	
Bath-shower mixer Tub outlet:	31 l/min
Bath-shower mixer Shower outlet:	24 l/min
Shower mixer:	32 l/min
Thermostatic mixer:	43 l/min
Thermostatic mixer with shut off unit / Shower Thermostatic mixer with electronic Start - Stop button:	26 l/min
Thermostatic mixer with shut off and diverter unit:	26 l/min
Thermostatic mixer High Flow:	58 l/min
iControl:	30 l/min
iControl mobile:	37 l/min



Thermostatic mixer (see page 118, 120, 126)



High Flow
Thermostatic mixer High Flow (see page 128 - 146)

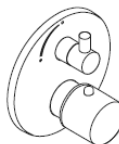

Thermostatic mixer with shut off unit (see page 102, 104, 106, 112, 122)

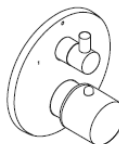

Thermostatic mixer with shut off and diverter unit (see page 98, 114, 116, 124)



Shower Thermostatic mixer with electronic Start - Stop button (see page 112)

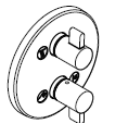

iControl Shut off and diverter unit (see page 144)



iControl mobile Shut off and diverter unit (see page 146)

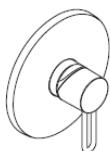

Shower mixer (see page 102, 104, 106, 112, 122)



Bath-shower mixer (see page 98, 100, 114, 116)



DVGW
Bath-shower mixer with integrated safety combination (see page 96)

Water can emerge at the safety combination in case of a defect!

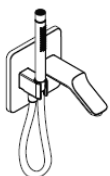

Bath Spout (see page 100)

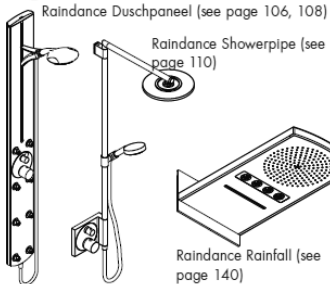





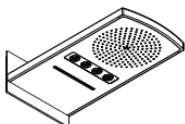









Raindance Duschpaneel (see page 106, 108)

Raindance Showerpipe (see page 110)



Raindance Rainfall (see page 140)

<p>X</p>	<p>Center bath tub / Center shower tub</p>		<p>Robinet d'arrêt encastré</p>
<p>Y</p>	<p>Dimension Y = center of hose wall outlet elbow to centre of bath filler divided by 2 (match to tile layout if applicable).</p>		<p>Quattro 4-Way Diverter Valve</p>
	<p>Warm water</p>		<p>Trio 2-Way Diverter Valve with integrated Shut-off valve</p>
	<p>Cold water</p>		<p>Bath Spout</p>
	<p>From • the function is guaranteed.</p>		<p>Plug the unused outlet. (DN 20 ¾")</p>
	<p>The wall must be reinforced in this area.</p>		<p>The waste drain performance must be more than 50 l/min.</p>
	<p>Only one function is possible.</p>		<p>Waste</p>
	<p>Install water pipes for body showers with a gradient.</p>		<p>iBox in combinaton with an Exafill bath filler with overflow and waste (see page 95)</p>

Installazione della tubazione

La rotazione simmetrica del corpo permette di raccordarsi agli attacchi sia verticalmente che orizzontalmente. Set vasca/doccia con valvola antiriflusso, è obbligatorio. Solo in caso di installazione del raccordarsi agli attacchi verticalmente.

Installare sempre l'iBox sopra alla vasca o al piatto doccia, poiché in caso di fuoriuscita d'acqua questa verrà convogliata allo scarico.

L' iBox è adatto tanto ad installazioni per vasca quanto per doccia. Per i miscelatori monocomando per vasca l' uscita inferiore ha la prevalenza. Nelle installazioni per doccia l' uscita non utilizzata deve essere chiusa con un tappo.

Installare il corpo incasso in modo tale che il raccordo dell' acqua calda si trovi a sinistra e il raccordo dell' acqua fredda a destra.

Profondità d'installazione: da 80 mm a 108 mm.

Prolunga 25 mm codice articolo 13595000

Prolunga 22 mm x set esterno (in caso di incasso troppo esterno al muro). codice articolo 13596XXX / 13597XXX / 97407XXX / 98860000

Il corpo incasso può essere installato conformemente alle condizioni edilizie, vedi esempi di installazione alle pagg. 91 e 92.

- A** Installazione a muro.
- B** Installazione a muro. Qui con la regolazione della distanza (vite nr 10).
- C** Montaggio su struttura portante.
- D** Installazione su pannelli di montaggio o celle prefabbricate.
- E** Installazione diretta a muro.
- F** Installazione con pareti in cartongesso 96615000.

Esempi per l'installazione con indicazioni delle misure e per le dimensioni delle tubature sono riportati a partire della pagina 96.

Per il significato dei simboli impiegati si vedano le pagine 12 e 13.

Suggerimento per l' installazione

Per avvitare i raccordi bloccare l' iBox nella morsa come illustrato.

Lavaggio della tubazione

Eeguire il lavaggio dell' impianto installato come suggerisce la normativa DIN 1988 / EN 1717. Le frecce sul corpo di lavaggio indicano quale alimentazione è collegata a quale tubo di uscita, ad es. acqua fredda con l' uscita inferiore e acqua calda con l' uscita superiore. Nel caso in cui sia utilizzata una sola uscita, dopo il primo processo di lavaggio il corpo di lavaggio deve essere ruotato di 90°.

iBox in combinazione con Exafill scarico con erogazione al troppo pieno (vedi pagg. 95)

Dati tecnici

Pressione d'uso:	max. 1 MPa
Pressione d'uso consigliata:	0,1 - 0,5 MPa
Pressione di prova:	1,6 MPa
(1 MPa = 10 bar = 147 PSI)	
Temperatura dell'acqua calda:	max. 80 °C
Temp. dell'acqua calda consigliata:	65 °C
Distanza di raccordo:	G 3/4"
Raccordi:	fredda a destra calda a sinistra
Portata a 0,3 MPa:	
Miscelatore vasca/doccia uscita vasca:	31 l/min
Miscelatore vasca/doccia uscita doccia:	24 l/min
Miscelatore doccia:	32 l/min
Termostatico:	43 l/min
Termostatico con rubinetto di arresto / Termostatico doccia incasso con pulsante elettronico	
Start - Stop:	26 l/min
Termostatico con rubinetto di arresto e deviatore:	26 l/min
Termostatico High Flow:	58 l/min
iControl:	30 l/min
iControl mobile:	37 l/min



Termostatico (vedi pagg. 118, 120, 126)



High Flow

Termostatico High Flow (vedi pagg. 128 - 146)



Termostatico con rubinetto di arresto (vedi pagg. 102, 104, 106, 112, 122)

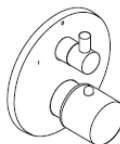

Termostatico con rubinetto di arresto e deviatore (vedi pagg. 98, 114, 116, 124)



Termostatico doccia incasso con pulsante elettronico Start - Stop (vedi pagg. 112)

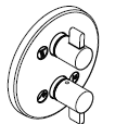

iControl
Rubinetto di arresto e deviatore (vedi pagg. 144)



iControl mobile
Rubinetto di arresto e deviatore (vedi pagg. 146)

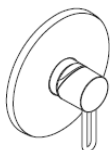

Miscelatore doccia (vedi pagg. 102, 104, 106, 112, 122)



Miscelatore vasca/doccia (vedi pagg. 98, 100, 114, 116)



DVGW

Miscelatore vasca incasso con sicurezza (valv. antiriflusso) (vedi pagg. 96)

In caso di difetto può fuoriuscire dell'acqua dalla combinazione di sicurezza

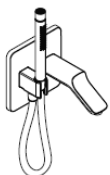

Bocca di erogazione (vedi pagg. 100)

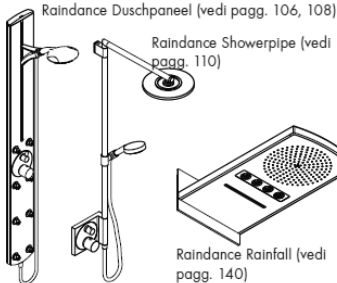





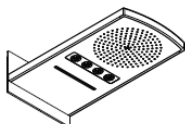









Raindance Duschpaneel (vedi pagg. 106, 108)

Raindance Showerpipe (vedi pagg. 110)



Raindance Rainfall (vedi pagg. 140)

- X** Centro vasca / Centro piatto doccia  Rubinetto di arresto
- Y** Valore Y = Dal centro del raccordo a muro al centro della bocca di erogazione vasca diviso 2 (eventualmente adattare alla dimensione delle piastrelle).  Quattro Valvola a quattro vie
-  Acqua calda  Trio arresto/deviatore
-  Acqua fredda  Bocca di erogazione
-  Dal • si garantisce la funzionalità.  Chiudere con un tappo l'uscita non utilizzata. (DN 20 3/4")
-  In questa zona è necessario un rinforzo della parete.  La portata di scarico deve essere superiore a 50 l/min.
-  Non è possibile utilizzare due utenze in contemporanea.  Scarico
-  Posizionare i tubi alle doccette laterali con una leggera pendenza.  iBox in combinazione con Exafill scarico con erogazione al troppo pieno (vedi pagg. 95)

Montaje del cuerpo empotrado

El cuerpo base del iBox universal se puede montar en plano horizontal y vertical. La única excepción se da al instalar el mezclador de baño/ducha con combinación de seguridad integrada. En tal caso, solo la instalación vertical es posible.

Instalar el iBox siempre por encima de la bañera ya que, si se rompiera alguna pieza del iBox, el agua estaría contenida.

El iBox universal puede ser utilizado para una grifería baño/ducha o ducha. En combinación con una instalación de ducha tiene prioridad la salida inferior. En combinación con un monomando ducha debe taparse la salida que no se utiliza.

Montar el cuerpo de tal manera que el agua caliente esté a la izquierda y el agua fría está en la derecha. Profundidad de montaje 80 mm a 108 mm. Prolongación 25 mm artículo número 13595000 Alargo 22 mm (en caso de pared delgada) artículo número 13596XXX / 13597XXX / 97407XXX / 98860000

El cuerpo empotrado puede ser colacado según los ejemplos expuestos en las páginas 91 y 92.

- A** Instalación directamente sobre la pared.
- B** Instalación sobre la pared. Aquí con soportes de distanciamiento y tornillos de acero de 10.
- C** Montaje en el sistema portante.
- D** Instalación en placas murales prefabricadas o en celdas prefabricadas.
- E** Instalación directa en la pared.
- F** Instalación con set de guías de fijación 96615000.

A partir de la página 96 puede consultar ejemplos de instalación y dimensionamiento de la conducción. La aclaración de los símbolos utilizados en las páginas 15 y 16.

Recomendación

Para enroscar los codos de conexión, fijar el iBox universal mediante un trozo de tubería en un tornillo de banco.

Purga de la tubería

Purgar la instalación según la normativa DIN 1988/ EN 1717. Las flechas en el bloque de purgar indican qué conducto de entrada está conectado con qué conducto de salida, p. ej. agua fría con la salida inferior y agua caliente con la salida superior. Si solamente se necesita una salida se debe girar el bloque de purgar 90° después del primer proceso de purgado.

iBox universal en combinación con Exafill, vaciador automático con chorro incorporado y rebosadero (ver página 95)

Datos técnicos

Presión en servicio:	max. 1 MPa
Presión recomendada en servicio:	0,1 - 0,5 MPa
Presión de prueba:	1,6 MPa
(1 MPa = 10 bar = 147 PSI)	
Temperatura del agua caliente:	max. 80 °C
Temp. recomendada del agua caliente:	65 °C
Racores excéntricos:	G 3/4"
Racores excéntricos:	a la derecha frío - a la izquierda caliente
Caudal con 0,3 MPa	
Monomando baño/ducha Salida bañera:	31 l/min
Monomando baño/ducha Salida surtidor de ducha:	24 l/min
Monomando ducha:	32 l/min
Termostato:	43 l/min
Termostato con llave de paso / Termostato para ducha con interruptor electrónica:	26 l/min
Termostato con llave de paso y distribuidor:	26 l/min
Termostato High Flow:	58 l/min
iControl:	30 l/min
iControl mobile:	37 l/min



Termostato (ver página 118, 120, 126)



High Flow

Termostato High Flow (ver página 128 - 146)



Termostato con llave de paso (ver página 102, 104, 106, 112, 122)

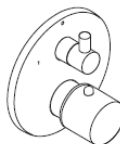

Termostato con llave de paso y distribuidor (ver página 98, 114, 116, 124)



Termostato para ducha con interruptor electrónico (ver página 112)

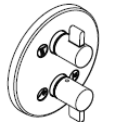

iControl
Llave de paso y distribuidor (ver página 144)



iControl mobile
Llave de paso y distribuidor (ver página 146)



Monomando ducha (ver página 102, 104, 106, 112, 122)



Monomando baño/ducha (ver página 98, 100, 114, 116)



DVGW

Monomando baño ducha con válvula anti-retorno (ver página 96)

En la combinación de seguro puede entrar agua en caso de avería.

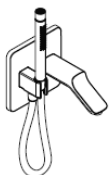

Caño de bañera (ver página 100)

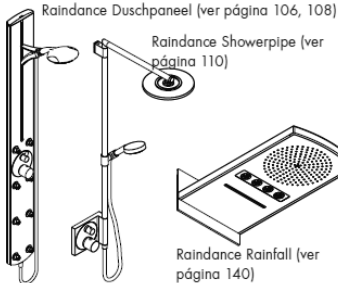





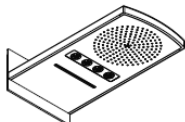









Raindance Duschpaneel (ver página 106, 108)

Raindance Showerpipe (ver página 110)



Raindance Rainfall (ver página 140)

<p>X</p>	<p>Centro de la bañera / Centro la plato de ducha</p>		<p>Llave de paso</p>
<p>Y</p>	<p>Medida Y = Desde el centro del racor de empalme hasta el centro de la boca de entrada a la bañera dividido por 2 (si fuera necesario, adaptar a la trama de los azulejos).</p>	 <p>Quattro</p>	<p>Quattro válvula de 4 vías</p>
	<p>Agua caliente</p>	 <p>T r i o</p>	<p>Trio llave de paso y distribuidor</p>
	<p>Agua fría</p>		<p>Caño de bañera</p>
	<p>Mínimo • para el correcto funcionamiento.</p>		<p>La salida que no se utiliza debe ser tapada. (DN 20 3/4")</p>
	<p>En este sector es necesario un refuerzo del muro.</p>		<p>El caudal de desagüe debe ser como mínimo de 50 l/min</p>
	<p>Sólo una función posible, no dos funciones al mismo tiempo.</p>	 <p>Raindrain</p>	<p>Desagüe</p>
	<p>Tubería hacia las duchas laterales con pendiente.</p>	 <p>Exafill</p>	<p>iBox universal en combinación con Exafill, vaciador automático con chorro incorporado y rebosadero (ver página 95)</p>

Ruwbouw

Het symmetrische basiscarnituur iBox universeel is zowel horizontaal als verticaal toe te passen. Uitgezonderd bij montage van een badmengkraan met zekerheidscombinatie, deze kan alleen verticaal worden ingebouwd.

Bij een defect functiedeel kan mogelijk water uit de iBox weglipen. Daarom moet de iBox boven het bad gemonteerd worden. Het lekwater wordt dan in het bad afgevoerd!

De iBox is zowel geschikt voor installatie bij het bad als bij de douche. Bij de ééngreeps badmengkraan heeft de onderste uitgang voorrang. Bij installatie in de douche moet de onbenodigde uitgang met een blindstop worden afgedicht.

Basiscarnituur zo inbouwen, dat de aansluiting voor warm water links en voor koud water rechts zit.
 Inbouwdiepte 80 mm tot 108 mm.
 Verlengstuk 25 mm Artikelnummer 13595000
 verlengset 22 mm (bij geringe inbouwdiepte) Artikelnummer 13596XXX / 13597XXX / 97407XXX / 98860000

Het basiscarnituur kan overeenkomstig de situatie ter plaatse worden ingebouwd. Montagevoorbeelden zie pag. 91 en 92.

- A** Installatie voor de wand.
- B** Installatie voor de wand.
- C** Montage op houdersysteem.
- D** Installatie op montageplaten voor prefab-huizen of kant-en-klare cellen.
- E** Installatie in de wand.
- F** Installatie met montageset 96615000.

Installatievoorbeelden met massagegevens en capaciteitsdimensionering staan op pagina 96.

De toelichting bij de gebruikte symbolen op pagina 18 en 19.

Montagetip

Om aansluitingen in te draaien de iBox door middel van een koppeling in de bankschroef vastzetten.

Spoelen

De complete installatie overeenkomstig DIN 1988/ EN 1717 spoelen. De pijlen op het spoelblok geven aan welke ingang met welke uitgang verbonden is, bv. koud water met de onderste uitgang en warm water met de bovenste uitgang. Wanneer slechts één uitgang wordt gebruikt, moet het spoelblok na de eerste spoeling 90° gedraaid worden.

iBox in combinatie met Exafill badvul-, afvoer- en overloopgarnituur (zie blz. 95)

Technische gegevens

Werkdruk: max.	max. 1 MPa
Aanbevolen werkdruk:	0,1 - 0,5 MPa
Getest bij:	1,6 MPa
(1 MPa = 10 bar = 147 PSI)	
Temperatuur warm water:	max. 80°C
Aanbevolen warm water temp.:	65°C
Aansluitmaten:	G ¾"
Aansluitingen:	koud rechts - warm links
Vrije doorstroom bij 0,3 MPa:	
Badmengkraan Uitlaat bad:	31 l/min
Badmengkraan Uitlaat douche:	24 l/min
Douchemengkraan:	32 l/min
Thermostaat:	43 l/min
Thermostaat met stopkraan / Douchethermostaat met start- en stopfunctie:	26 l/min
Thermostaat met stop- en omstelkraan:	26 l/min
Thermostaat High Flow:	58 l/min
iControl:	30 l/min
iControl mobile:	37 l/min



Thermostaat (zie blz. 118, 120, 126)



High Flow

Thermostaat High Flow (zie blz. 128 - 146)

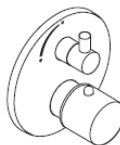

Thermostaat met stopkraan (zie blz. 102, 104, 106, 112, 122)

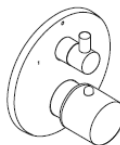

Thermostaat met stop-en omstelkraan (zie blz. 98, 114, 116, 124)

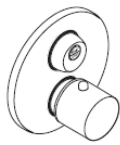

Douchethermostaat met start-en stopfunctie (zie blz. 112)

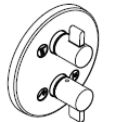

iControl Stop-en omstelkraan (zie blz. 144)



iControl mobile Stop-en omstelkraan (zie blz. 146)

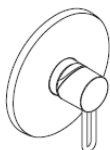

Douchemengkraan (zie blz. 102, 104, 106, 112, 122)



Badmengkraan (zie blz. 98, 100, 114, 116)



DVGW

Badmengkraan met geïntegreerde zekerheidscombinatie (zie blz. 96)

Bij een defect kan aan de zekerheidscombinatie water ontsnappen!

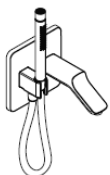

Baduitloop (zie blz. 100)

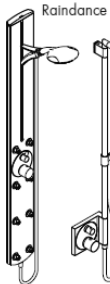

Raindance Duschpaneel (zie blz. 106, 108)

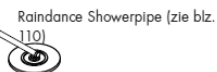

Raindance Showerpipe (zie blz. 110)

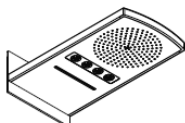

Raindance Rainfall (zie blz. 140)

X	Midden bad / Midden Douchebak		Inbouwstopkraan
Y	Maat Y = afstand tussen muuraansluit-bocht en baduitloop hart op hart, gedeeld door 2 (eventueel rekening houden met de wandtegels).	 Quattro	Quattro 4-weg omstelkraan
	Warm water	 T r i o	Trio stop- en omstelkraan
	Koud water		Baduitloop
	Vanaf • is het functioneren gegarandeerd.		De niet benodigde uitgang moet met een blindstop worden afgedicht. (DN 20 3/4")
	In dit bereik is een wandversterking noodzakelijk.	 > 50 l/min	De afvoercapaciteit moet meer dan 50 l/min bedragen.
	Slechts 1 functie mogelijk: geen 2 functies tegelijkertijd.	 Raindrain	Afvoer
	Waterleidingen voor zijdouches aflopend plaatsen.	 Exafill	iBox in combinatie met Exafill badvul-, afvoer- en overloopgarnituur (zie blz. 95)

Råmontage

I-boxens grundkrop er universel – kan monteres horisontalt og vertikalt. Undtagelsen er dog ved montering af kar/brusearmaturet med integreret sikkerhedskombination, her er kun den vertikale montering mulig.

Da der ved evt. defekt vil komme vand i I-boxen, skal denne monteres over karet, således at vandet ledes ned i karet!

I-boxen er egnet til såvel kar- som til bruseinstallation. Ved 1-grebs kararmatur er afgang forneden primærafgang. Ved bruseinstallation skal den overfløede afgang afroppe.

Grundkroppen indbygges således, at varmtvandsstilslutningen er til venstre og koldt vandsstilslutningen er til højre. Monteringsdybde 80 mm til 108 mm. Forlængersæt 25 mm art. nr. 13595000 Forlænger 22 mm (ved for stor indbygningsdybde) art. nr. 13596XXX / 13597XXX / 97407XXX / 98860000

For monteringseksempler se s. 91 og 92.

- A** Installation på væggen.
- B** Installation på væggen. Her med fleksibel afstandsholder med 10 mm justerbar monteringskrue.
- C** Montering på skinnedsystemet.
- D** Installering på monteringsplader til præfabrikerede huse.
- E** Installation direkte i væggen.
- F** Installation med monterings-skinnesæt 96615000.

Installationseksempler med mål og ledningsdimensioner kan efterlæses fra side 96.

Forklaringer til symbolerne findes på side 21 og 22.

Monterings-tips

For montering af tilslutningsvinkler, kan iBoxen fastspændes i en skrue/ringe ved hjælp af et rørstykke.

Gennemskylning

Den komplette installation skal gennemskylnes efter DIN 1988 / EN 1717.

Pilene på skylleblokken viser, hvilke tilgange og afgang der er forbundet med hinanden, f.eks. koldt vand med afgang forneden og varmt vand med afgang foroven. I tilfælde hvor kun én afgang benyttes, skal skylleblokken drejes 90° efter første gennemskylning.

iBox i kombination med Exafill påfyldnings- og overløbsgarniture (se s. 95)

Tekniske data

Driftstryk:	max. 1 MPa
Anbefalet driftstryk:	0,1 - 0,5 MPa
Prøvetryk:	1,6 MPa
(1 MPa = 10 bar = 147 PSI)	
Varmtvandstemperatur:	max. 80 °C
Aanbevolen warm water temp.:	65 °C
Tilslutningsmål:	G ¾"
Tilslutninger:	Koldt højre - varmt venstre
Fri gennemstrømning ved 0,3 MPa:	
Kararmaturer Afløb kar:	31 l/min
Kararmaturer Afløb bruser:	24 l/min
Brusearmaturer:	32 l/min
Termostat:	43 l/min
Termostat med afspæringsventil / Brusetermostat med elektronisk start-/stopknop.:	26 l/min
Termostat med afspæringsventil og omskifter:	26 l/min
Termostat High Flow:	58 l/min
iControl:	30 l/min
iControl mobile:	37 l/min



Termostat (se s. 118, 120, 126)



High Flow

Termostat High Flow (se s. 128 - 146)



Termostat med afspæringsventil (se s. 102, 104, 106, 112, 122)

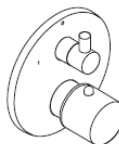

Termostat med afspæringsventil og omskifter (zie blz. 98, 114, 116, 124)



Brusetermostat med elektronisk start-/stopknop. (se s. 112)

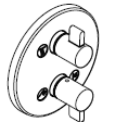

iControl Afspæringsventil og omskifter (se s. 144)



iControl mobile Afspæringsventil og omskifter (se s. 146)



Brusearmaturer (se s. 102, 104, 106, 112, 122)



Kararmaturer (se s. 98, 100, 114, 116)



DVGW

Kararmatur med integreret sikkerhedskombination. (se s. 96)

Hvis der foreligger en defekt, kan der udræde vand på sikkerhedskombinationen!

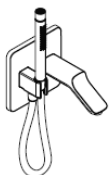

Kartud (se s. 100)

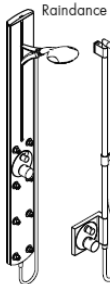





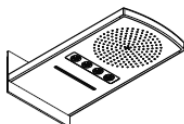











Raindance Duschpaneel (se s. 106, 108)

Raindance Showerpipe (se s. 110)



Raindance Rainfall (se s. 140)

	<p>Midt badekar / Midt brusekar</p>		<p>Afspæringsventil</p>
	<p>Mål Y = Midt slangeudtag til midt kartud divideret med 2 (evt. tilpas med fugerne i fliserne).</p>	 Quattro	<p>Quattro 4-vejs ventil</p>
	<p>Varmt vand</p>	 T r i o	<p>Trio afspæringsventil og omskifter</p>
	<p>Kold vand</p>		<p>Kartud</p>
	<p>Fra • er funktionen anvendelig.</p>		<p>Afgangen, der ikke benyttes, skal afpropes. (DN 20 ¾")</p>
	<p>I dette område er en forstærkning af væggen nødvendig.</p>		<p>Afløbskapaciteten skal være mere end 50 l/min.</p>
	<p>Det er kun muligt at benytte én funktion ad gangen.</p>	 Raindrain	<p>Afløb</p>
	<p>Vandledningerne til sidebruserne med fald.</p>	 Exafill	<p>iBox i kombination med Exafill påfyldnings- og overløbsgarniture (se s. 95)</p>

Instalação embutida na parede

O corpo de rotação simétrica pode ser instalado quer na horizontal quer na vertical. A única excepção é ao instalar uma misturadora de banheira/chuveiro com combinação de segurança. Neste caso, apenas é possível uma instalação vertical

Instalar a iBox sempre sobre a banheira. No caso de haver algum defeito nas peças da iBox a água pode fluir para lá.

A iBox é aplicável numa instalação de banheira e de chuveiro. Na misturadora de monobloco para banheira, a saída inferior é prioritária. Na instalação num chuveiro é necessário vedar a saída desnecessária com um tampão.

Instalar o corpo com a ligação para água quente à esquerda e a ligação para a água fria à direita. Profundidade de montagem 80 mm até 108 mm. Crescente 25 mm referência 13595000 Crescente 22 mm (quando instalado demasiado longe da parede) referência 13596XXX / 13597XXX / 97407XXX / 98860000

O corpo pode, dependendo da construção, ser instalado de diferentes maneiras, ver nas páginas 91 e 92 exemplos de instalação

- A** Instalação sobre a parede.
- B** Instalação sobre a parede com calçoa ajustáveis de 10 mm.
- C** Montagem no sistema de suporte.
- D** Instalação nas placas de montagem de pré-fabricado ou células pré-fabricadas.
- E** Instalação em paredes de tijolo.
- F** Instalação com set de fixação 96615000.

Exemplos de instalação com indicações dimensionais e dimensionamento das tubagens, podem ser encontrados a partir da página 96.

A explicação dos símbolos empregues, encontra-se na página 24 e 25.

Conselho para montagem

Para instalar as curvas de ligação na iBox coloque um tubo na iBox e prenda-o num torno.

Purgar as tubagens

Para completar a instalação purgar as tubagens da água quente e da água fria. As setas no corpo de descarga estão a mostrar que entrada está ligada com que saída, por exemplo, água fria com saída 1 e água quente com saída 2. Se apenas estiver em uso uma saída, após a 1ª purgagem o corpo de descarga deve ser rodado cerca de 90°.

iBox em combinação com Exafill com bica e avisador (ver página (ver página 95)

Dados Técnicos

Pressão de funcionamento:	max. 1 MPa
Pressão de func. recomendada:	0,1 - 0,5 MPa
Pressão testada:	1,6 MPa
(1 MPa = 10 bar = 147 PSI)	
Temperatura da água quente:	max. 80 °C
Temp. água quente recomendada:	65 °C
Distância entre eixos:	G 3/4"
Ligações:	fria à direita - quente à esquerda
Caudal a 0,3 MPa:	
Misturadora de banheira/chuveiro Saída da banheira:	31 l/min
Misturadora de banheira/chuveiro Saída do chuveiro:	24 l/min
Misturadora de chuveiro:	32 l/min
Misturadora termostática:	43 l/min
Misturadora termostática com válvula de corte / Misturadora termostática de duche com botão electrónico Start/Stop:	26 l/min
Misturadora termostática com Inversor/válvula de corte:	26 l/min
Misturadora termostática High Flow:	58 l/min
iControl:	30 l/min
iControl mobile:	37 l/min



Misturadora termostática (ver página 118, 120, 126)



High Flow
Misturadora termostática High Flow (ver página 128 - 146)

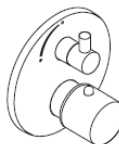

Misturadora termostática com válvula de corte (ver página 102, 104, 106, 112, 122)

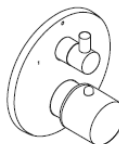

Misturadora termostática com inversor/válvula de corte (ver página 98, 114, 116, 124)



Misturadora termostática de duche com botão electrónico Start/Stop (ver página 112)

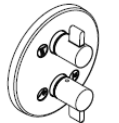

iControl
Inversor / válvula de corte (ver página 144)



iControl mobile
Inversor / válvula de corte (ver página 146)

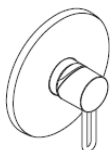

Misturadora de chuveiro (ver página 102, 104, 106, 112, 122)



Misturadora de banheira/chuveiro (ver página 98, 100, 114, 116)



DVGW
Misturadora de banheira/duche com combinação de segurança integrada (ver página 96)

Em caso de um defeito é possível a fuga de água pela combinação de segurança!

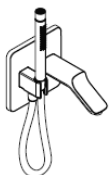

Entrada de banheira (ver página 100)

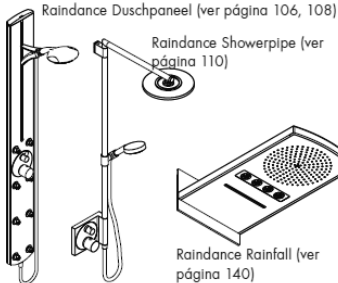





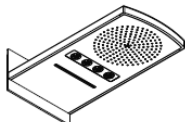





Raindance Duschpaneel (ver página 106, 108)

Raindance Showerpipe (ver página 110)



Raindance Rainfall (ver página 140)

<p>X</p>	<p>Meio da banheira / Meio da base de duche</p>		<p>Torneira de passagem</p>
<p>Y</p>	<p>Medida Y=Centro da curva de ligação até ao centro da bica da banheira dividido por 2 (conjugar com os azulejos, se fôr o caso).</p>		<p>Quattro válvula de diversão de 4 vias</p>
	<p>Água quente</p>		<p>Trio universal inversor/válvula de corte</p>
	<p>Água fria</p>		<p>Entrada de banheira</p>
	<p>• A partir deste ponto inicia-se o funcionamento correcto.</p>		<p>Tamponar a saída não utilizada. (DN 20 3/4")</p>
	<p>Nesta zona é necessário um reforço na parede.</p>		<p>Capacidade de escoamento tem que ser superior a 50 l/min.</p>
	<p>Apenas uma saída de cada vez, não duas simultâneamente.</p>		<p>Escoamento</p>
	<p>Instalar os tubos para os chuveiros laterais com ligeira inclinação.</p>		<p>iBox em combinação com Exafill com bica e avisador (ver página 95)</p>

Montaż przyłączy

Uniwersalny okrągły kształt korpusu iBox pozwala na dowolny sposób montażu i zabudowy, zarówno pionowy jak i poziomy. Z wyjątkiem montażu armatury wannowej ze zintegrowanym systemem zabezpieczającym do wylewki, możliwy jest tylko montaż pionowy

W przypadku uszkodzenia jakichkolwiek elementów przepływająca woda może kapać z iBoxa, dlatego też należy zamontować go nad wanną, dzięki czemu woda będzie mogła spływać do wanny.

iBox można wykorzystać zarówno jako baterię wannową jak i jako baterię natryskową. Przy jednonouchwytowym mieszaczu wannowym dolne wyjście ma pierwszeństwo. Przy instalacji prysznicowej niepotrzebne wyjście musi zostać zamknięte korkiem uszczelniającym.

Korpus zabudować w taki sposób, aby przyłącza zimnej wody znajdowały się po prawej stronie, a ciepłej po lewej.

Głębokość montażu 80 - 108 mm

Przedłużka 25 mm nr art. 13595000

Rozeta maskująca 22 mm (przy małej głębokości zabudowy) nr art. 13596XXX / 13597XXX / 97407XXX/ 98860000

Korpus może zostać zabudowany w różnych stadiach budowlanych, przykłady montażowe patrz str.91 i 92.

- A** Instalacja na ścianie.
- B** Instalacja przed ścianą. Na śrubach gwintowanych M10 jako elementy dystansowe.
- C** Montaż na systemie stelaży.
- D** Instalacja w ścianach prefabrykowanych domów gotowych.
- E** Instalacja w ścianie.
- F** Instalacja z szynami mocującymi 96615000.

Przykłady instalacji z podaniem ciężarów i rozmiarów przewodów, patrz od strony 96.

Wyjaśnienie używanych symboli, patrz strona 27 i 28.

Wskazówki montażowe

Aby dokręcić przyłącza, zamocować iBox w imadle.

Płukanie

Przepłukać całą instalację zgodnie z normą DIN 1988/ EN 1717. Strzałki na bloku płuczącym wskazują, który dopływ jest połączony z odpływem, np. zimna woda z dolnym odpływem, a ciepła woda z górnym odpływem. Jeżeli potrzebny jest jedynie jeden odpływ, po pierwszym płukaniu należy przekręcić blok płuczący o 90°.

iBox w kombinacji z odpływem wannowym Exafill posiadającym możliwość napełniania i opróżniania wanny (patrz strona 95)

Dane techniczne

Ciśnienie robocze:	maks. 1 MPa
Zalecane ciśnienie robocze:	0,1 - 0,5 MPa
Ciśnienie próbne:	1,6 MPa
(1 MPa = 10 bary = 147 PSI)	
Temperatura wody gorącej:	maks. 80 °C
Zalecana temperatura wody gorącej:	65 °C
Wymiary przyłącza:	G 3/4"
Przyłącza:	Zimna prawo - ciepła lewo
Swobodny przepływ przy 0,3 MPa:	
Mieszacz wannowy Odpływ wanny:	31 l/min
Mieszacz wannowy Odpływ prysznicowy:	24 l/min
Mieszacz prysznicowy:	32 l/min
Termostat:	43 l/min
Termostat z zaworem odcinającym / Termostat prysznicowy z elektronicznym przyciskiem	
Start / Stop:	26 l/min
Termostat z zaworem odcinająco-przełączającym:	26 l/min
Termostat High Flow:	58 l/min
iControl:	30 l/min
iControl mobile:	37 l/min



Termostat (patrz strona 118, 120, 126)



High Flow

Termostat High Flow (patrz strona 128 - 146)

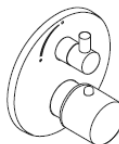

Termostat z zaworem odcinającym (patrz strona 102, 104, 106, 112, 122)

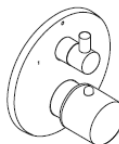

Termostat z zaworem odcinająco-przełączającym (patrz strona 98, 114, 116, 124)



Termostat prysznicowy z elektronicznym przyciskiem Start / Stop (patrz strona 112)

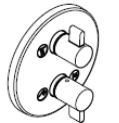

iControl Zawór odcinający i regulacyjny (patrz strona 144)



iControl mobile Zawór odcinający i regulacyjny (patrz strona 146)



Mieszacz prysznicowy (patrz strona 102, 104, 106, 112, 122)



Mieszacz wannowy (patrz strona 98, 100, 114, 116)



DVGW

Mieszacz wannowy ze zintegrowanym systemem zabezpieczającym do wylewki (patrz strona 96)

W kombinacji zabezpieczającej przy uszkodzeniu może pojawić się woda!

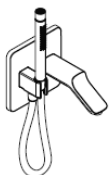

Wylewka wannowa (patrz strona 100)

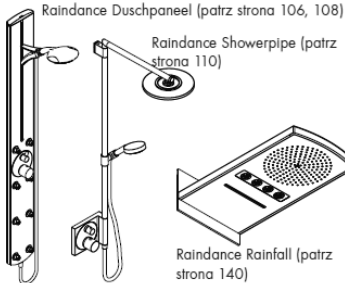





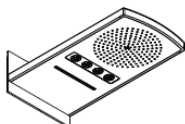









Raindance Duszchpaneel (patrz strona 106, 108)

Raindance Showerpipe (patrz strona 110)



Raindance Rainfall (patrz strona 140)

X	Środek wanny / Środek brodzika		Zawór podtynkowy
Y	Wymiar Y = środek mocowania węża prysnicowego do środka wylewki napełniającej wannę podzielony przez 2 (ewentualnie dopasować do układu płytek ceramicznych).	 Quattro	Regulator czterodrożny Quattro
	Ciepła woda	 T r i o	Zawór odcinający i regulacyjny Trio Universal
	Zimna woda		Wylewka wanny
	Od • możliwe jest funkcjonowanie.		Niewykorzystany wylot należy zakorkować dołożonym w dostawie korkiem. (DN 20 3/4")
	W tym obszarze konieczne jest wzmocnienie ściany.	 > 50 l/min	Wydajność odpływu musi być wyższa niż 50 l/min.
	Możliwe uruchamianie tylko każdego odbiornika osobno.	 Raindrain	Odpływ
	Przewody doprowadzające do pryszniców bocznych położyć z nachyleniem.	 Exafill	iBox w kombinacji z odpływem wannowym Exafill posiadającym możliwość napełniania i opróżniania wanny (patrz strona 95)

Hrubá montáž

Rotačně symetrické základní těleso iBoxu je univerzálně použitelné, horizontálně jakož i vertikálně. Neplatí pro montáž vanové armatury s bezpečnostní kombinací, zde je možná pouze vertikální montáž.

Protože v případě závady funkčních dílů může začít z jednotky iBox vytékat voda, musí být iBox instalován nad vanou, která vytékající vodu odvede.

iBox je vhodný jak pro vanovou, tak i pro sprchovou instalaci. U vanové jednoruční pákové batele je prioritní spodní vývod. U sprchové instalace musí být nepoužitý vývod utěsněn zaslepečovací zátkou

Základní těleso zabudovat tak, aby se připoj teplé vody nacházel vlevo a připoj studené vody vpravo.
Hloubka zabudování 80 mm až 108 mm.
prodloužení 25 mm kat.č. 13595000
prodloužení 22 mm (při malé hloubce zabudování) kat. č. 13596XXX / 13597XXX / 97407XXX / 98860000

Základní těleso může být namontováno v souladu s podmínkami na stavbě, příklady montáže viz strana 91 a 92.

- A** Instalace na stěnu.
- B** Instalace před stěnu. Zde s variabilními rozpěrkami pomocí šroubů M 10.
- C** Montáž na nosný systém.
- D** Instalace na montážní desky nebo prefabrikované díly typizovaného domu.
- E** Instalace přímo do stěny.
- F** Instalace se sadou montážních lišt 96615000.

Příklady instalace s údaji o rozměrech a dimenzování potrubí jsou uvedeny od strany 96.
Vysvětlivky k použitým symbolům naleznete na straně 30 a 31.

Montážní tip

Abyste bylo možno zatočit připojovací tvarovky do iBoxu, upněte iBox pomocí části trubky do svěráku.

Propláchnutí

Kompletní instalaci propláchnout podle normy DIN 1988 / EN 1717. Šipky na proplachovacím bloku ukáží, který přívod je spojen se kterým vedením vývodu, např. studená voda se spodním vývodem a teplá voda s horním vývodem. Je-li potřebný pouze jeden vývod, musí být po prvním vypláchnutí proplachovací blok otočen o 90 stupňů.

iBox v kombinaci s vanovým napouštěním Exafill s odpadní a přeřadovou garniturou (viz strana 95)

Technické údaje

Provozní tlak:	max. 1 MPa
Doporučený provozní tlak:	0,1 - 0,5 MPa
Zkušební tlak:	1,6 MPa
(1 MPa = 10 bar = 147 PSI)	
Teplota horké vody:	max. 80 °C
Doporučená teplota horké vody:	65 °C
Rozteč připojení:	G ¾"
Připoje:	studená vpravo - teplá vlevo
Volný průtok při 0,3 MPa	
vanová baterie Odtok vany:	31 l/min
vanová baterie Odtok sprchy:	24 l/min
Sprchová armatura:	32 l/min
Termostat:	43 l/min
Termostat s uzavíracím ventilem / Sprchový termostat s elektronickým tlačítkem start/stop:	26 l/min
Termostat s uzavíracím a přepínacím ventilem:	26 l/min
Termostat High Flow:	58 l/min
iControl:	30 l/min
iControl mobile:	37 l/min



Termostat (viz strana 118, 120, 126)



High Flow

Termostat High Flow (viz strana 128 - 146)



Termostat s uzavíracím ventilem (viz strana 102, 104, 106, 112, 122)

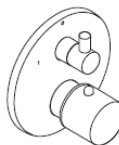

Termostat s uzavíracím a přepínacím ventilem (viz strana 98, 114, 116, 124)



Sprchový termostat s elektronickým tlačítkem start/stop (viz strana 112)

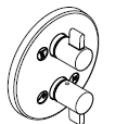

iControl Uzavírací a přepínací ventil (viz strana 144)



iControl mobile Uzavírací a přepínací ventil (viz strana 146)

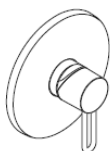

Sprchová armatura (viz strana 102, 104, 106, 112, 122)



vanová baterie (viz strana 98, 100, 114, 116)



DVGW

Vanová baterie s integrovanou bezpečnostní kombinací (viz strana 96)

U pojistné kombinace může při závadě vystupovat voda!

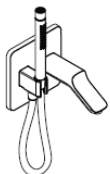

Vanový vtok (viz strana 100)

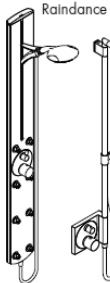





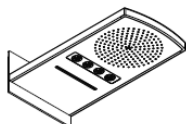









Raindance Duschpaneel (viz strana 106, 108)

Raindance Showerpipe (viz strana 110)



Raindance Rainfall (viz strana 140)

<p>X</p>	<p>Střed koupací vany / Střed sprchové vany</p>		<p>Podomítkový uzavírací ventil</p>
<p>Y</p>	<p>Rozměr Y = vzdálenost středu připojení sprchové hadice od středu vanového napouštění dělitelná 2 (eventuelně přizpůsobit rozměru obkladů).</p>	 <p>Quattro</p>	<p>Quattro čtyřcestné přestavování</p>
	<p>Teplá voda</p>	 <p>T r i o</p>	<p>Trio Universal - Uzavírací a přepínací ventil</p>
	<p>Studená voda</p>		<p>Vanový vtok</p>
	<p>Od • je zaručená funkce</p>		<p>Nepoužitý vývod musí být utěsněn zaslepovací zátkou. (DN 20 3/4")</p>
	<p>V této oblasti je potřebné zesílení stěny.</p>		<p>Odtokový výkon musí být vyšší než 50 l/min.</p>
	<p>Je možné použít pouze jeden spotřebič, ne dva současně.</p>	 <p>Raindrain</p>	<p>Odtok</p>
	<p>Vodovodní potrubí pro boční sprchy nainstalovat se spádem.</p>	 <p>Exafill</p>	<p>iBox v kombinaci s vanovým napouštěním Exafill s odpadní a přepadovou garniturou (viz strana 95)</p>

Hrubá montáž

Rotačne symetrické základné teleso iBoxu je univerzálne použiteľné, horizontálne aj vertikálne. Neplatí pro montáž vanové armatury s bezpečnostní kombinací, zde je možná pouze vertikální montáž.

Pretože v prípade poruchy funkčných častí môže začať z jednotky iBox vytekať voda, musí byť iBox namontovaný nad vaňou, ktorá vytekajúcu vodu odvedie.

iBox je vhodný tak pre vaňovú ako aj sprchovú inštaláciu. Pre jednoručnú pákovú vaňovú batériu je prioritný spodný vývod. Pre sprchovú inštaláciu musí byť nepoužitý vývod zaslepený zátkou.

Základné teleso zabudovať tak, aby prívod teplej vody bol vľavo a prívod studenej vody vpravo.

Montážna hĺbka: 80 mm až 108 mm.

Predĺženie 25 mm výrobné číslo 13595000

Predĺženie 22 mm (pri malej montážnej hĺbke).

výrobné číslo 13596XXX / 13597XXX / 97407XXX / 98860000

Základné teleso je montované podľa podmienok na stavbe podľa príkladov inštalácie vii strana 91 a 92.

- A** Inštalácia na stenu.
- B** Inštalácia pred stenu pomocou nastaviteľných 10 mm skrutiek.
- C** Montáž na nosný systém.
- D** Inštalácia na montážne platne prefabrikovanej konštrukcie alebo na hotové články.
- E** Inštalácia priamo do steny.
- F** Inštalácia so sadou montážnych listů 96615000.

Inštalčné príklady s uvedením rozmerov a výkonov nájdete od strany 96.

Vysvetlenie použitých symbolov nájdete na strane 33 a 34.

Montážny tip

Aby sa dali pripojovacie kusy dobre zatočiť, upne sa iBox pomocou trubkovej tvarovky do zveráku.

Prepláchnutie

Kompletnú inštaláciu prepláchnuť podľa normy DIN 1988 / EN 1717. Šípky na preplachovacom bloku ukazujú, ktorý prívod je spojený s ktorým vedením vývodu, napr. prívod studenej vody so spodným vývodom, prívod teplej vody s horným vývodom. Ak je použitý len jeden vývod, musí byť po prvom prepláchnutí preplachovací blok otočený o 90 stupňov.

iBox kombinovaný s EXAFILL vaňovým napúšťaním s odpadovou a prepadovou garnitúrou (viď strana 95)

Technické údaje

Prevádzkový tlak:	max. 1 MPa
Doporučený prevádzkový tlak:	0,1 - 0,5 MPa
Skúšobný tlak:	1,6 MPa
(1 MPa = 10 bar = 147 PSI)	
Teplota teplej vody:	max. 80 °C
Doporučená teplota teplej vody:	65 °C
Pripájacie rozmery:	G ¾"
Pripoje:	studená vpravo - teplá vľavo
Volný prietok pri 0,3 MPa	
vaňová batéria Odtok vane:	31 l/min
vaňová batéria Odtok sprchy:	24 l/min
Sprchová batéria:	32 l/min
Termostatická batéria:	43 l/min
Termostatická batéria s uzatváracím ventilom / Termostatická batéria s elektronickým tlačidlom start/stop:	26 l/min
Termostatická batéria s uzatváracou jednotkou a prestačovacím ventilom:	26 l/min
Termostatická batéria High Flow:	58 l/min
iControl:	30 l/min
iControl mobile:	37 l/min



Termostatická batéria (viď strana 118, 120, 126)



High Flow
Termostatická batéria High Flow (viď strana 128 - 146)

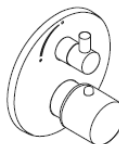

Termostatická batéria s uzatváracím ventilom (viď strana 102, 104, 106, 112, 122)

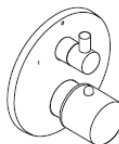

Termostatická batéria s uzatváracou jednotkou a prestavovacím ventilom (viď strana 98, 114, 116, 124)



Termostat sprchy s elektronickým tlačidlom start/stop (viď strana 112)

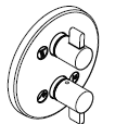

iControl
Uzatvárací a prestavovací ventil (viď strana 144)



iControl mobile
Uzatvárací a prestavovací ventil (viď strana 146)



Sprchová batéria (viď strana 102, 104, 106, 112, 122)



vaňová batéria (viď strana 98, 100, 114, 116)



DVGW
mešalna baterija za kopalno kad z vgrajeno varovalno kombinacijo (viď strana 96)

Na kombinácii poistiek môže v prípade chyby vystupovať voda!

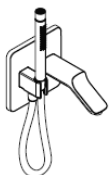

Vaňový vtok (viď strana 100)

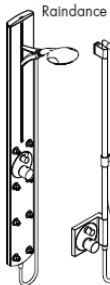





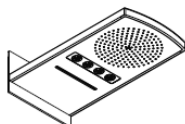









Raindance Duschpaneel (viď strana 106, 108)

Raindance Showerpipe (viď strana 110)



Raindance Rainfall (viď strana 140)

- X** Stred vane / Stred sprchovej vane  Podomietkový uzatvárací ventil
- Y** Rozmer Y = vzdialenosť stredu pripojenia sprchovej hadice od stredu vaňového napúšťania deliteľná 2 (prípadne prispôsobí rozmeru obkladu)  Quattro štvorcestné prestavenie
-  Teplá voda  Trio univerzálny uzatvárací a nastavovací ventil
-  Studená voda  Vaňový vtok
-  Od • je zaručená funkcia.  Nepoužitý vývod musí byť zaslepený zátkou. (DN 20 3/4")
-  V tejto oblasti je potrebné zosilnenie steny.  Výkon odtoku musí byť vyšší ako 50 l/min.
-  Je možné používať len jeden spotrebič, nie oba súčasne.  Odtok
-  Vodovodné potrubie pre bočné sprchy vspádovať.  iBox kombinovaný s EXAFILL vaňovým napúšťaním s odpadovou a prepádovou garnitúrou (viď strana 95)

粗安装

iBox的旋转对称基体可以作为万能部件使用，在此只能垂直安装。

始终在浴缸上面安装iBox，如果iBox零件即将断裂，水可能从这里流出！

iBox 不仅适用于槽安装，同样也适用于花洒安装。安装单手槽装置时，下出水口优先。安装花洒时，必须使用堵头密封不需要的出水口。

基体安装在热水连接装置左侧和冷水连接装置右侧。

安装深度：80mm至108 mm。

加长 商品编号 13595000

加长件22mm（墙壁不够深时）商品编号

13596XXX / 13597XXX / 97407XXX / 98860000

根据构造的实际情况安装基体，安装范例参见第91页和第92页。

A直接墙面安装。

B直接墙面安装，带10 mm可调节的固定柱头螺栓。

C安装在支柱上。

D安装在预制装配式房屋—装配平台或预制装配式小室。

E砖墙安装

F使用固定组件安装 96615000。

带数据和管道尺寸的安装实例请从96页起查找。所使用符号的说明参见36页和37页。

安装提示

iBox通过管件在台虎钳内处理，这样可以旋入连接件。

冲洗管系统

按照德国工业标准1988/欧洲标准1717清洁全部安装件。清洗端上的箭头显示，该进水口与其出水导通装置连接。例如：冷水与下出水口连接，热水与上出水口连接。如果只需要一个出水口，那么，在第一个清洁过程后，将冲洗端旋转90°。

iBox与下水部件组合，配备出水组件及溢流组件（参见第95页）

技术参数

工作压力:	最大 1 MPa
推荐工作压力:	0,1 - 0,5 MPa
测试压强:	1,6 MPa
(1 MPa = 10 bar = 147 PSI)	
热水温度:	最大 80°C
推荐热水温度:	65°C
中心距离:	G ¾"
连接管线:	左热右冷
0,3 MPa时的流速:	
浴缸-淋浴龙头 面盆岔管:	31 升/分钟
浴缸-淋浴龙头 蓬蓬头岔管:	24 升/分钟
淋浴龙头:	32 升/分钟
恒温龙头:	43 升/分钟
恒温龙头及闭锁单元 / 淋浴器恒温龙头带有电子启动-停止按钮:	26 升/分钟
恒温龙头及闭锁和分流器单元:	26 升/分钟
恒温龙头 High Flow:	58 升/分钟
iControl:	30 升/分钟
iControl mobile:	37 升/分钟



恒温龙头 (参见第页 118, 120, 126)



High Flow
恒温龙头 High Flow (参见第页 128 - 146)

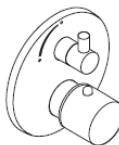

恒温龙头及闭锁单元 (参见第页 102, 104, 106, 112, 122)

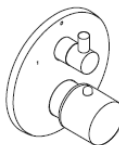

恒温龙头及闭锁和分流器单元 (参见第页 98, 114, 116, 124)

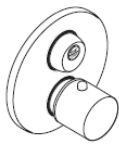

淋浴器恒温龙头带有电子启动-停止按钮 (参见第页 112)

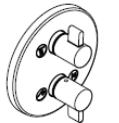

iControl
截止阀和换向阀 (参见第页 144)



iControl mobile
截止阀和换向阀 (参见第页 146)

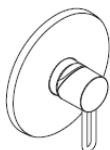

淋浴龙头 (参见第页 102, 104, 106, 112, 122)



浴缸-淋浴龙头 (参见第页 98, 100, 114, 116)



DVGW
浴缸淋浴龙头及整体式安全组合 (参见第页 96)

出现故障时, 水会从安全组合部位流出!

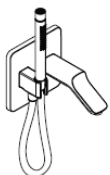

浴缸出水口 (参见第页 100)

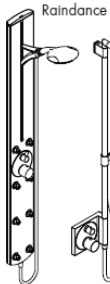

Raindance Duschpaneel (参见第页 106, 108)

Raindance Showerpipe (参见第页 110)

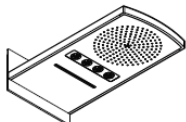

Raindance Rainfall (参见第页 140)

- X** 槽中间 / 中心淋浴盆  截止阀
- Y** 尺寸Y = 软管壁出口弯管的中心至浴盆加水口中心除以2 (匹配瓷砖布置)。
 Quattro 四通转换器
-  热水  通用的三通截止阀和换向阀
-  冷水  浴缸出水口
-  从•开始, 正常功能得以保证。
 插入不使用的插座。(DN 20 3/4")
-  该区域需要一个加固边壁。
 排水功率必须大于 50 l/min.
-  只有一项功能。
 Raindrain 排水口
-  安装水管, 用于带有梯度的淋浴器。
 Exafill iBox与下水部件组合, 配备出水组件及溢流组件 (参见第95页)

предварительный монтаж

Вращательно-симметричный корпус iBox может использоваться универсально, как горизонтально, так и вертикально. Кроме монтажа арматуры ванны с комбинированным предохранителем здесь возможна только вертикальная установка.

Поскольку при неисправности функциональных деталей у iBox может выходить вода, iBox необходимо монтировать над ванной, чтобы выступающая вода могла стекать в ванну!

iBox предназначен для монтажа как ванн, так и душей. Для однорычажного смесителя для ванны преимущество имеет нижний отвод. При монтаже душа ненужный выход необходимо закрыть пробкой.

Установите корпус так, чтобы подключение горячей воды находилось слева, а холодной – справа.
Глубина установки от 80 до 108 мм.
Удлинение 25 мм арт. № 13595000
Удлинение 22 мм (при малой глубине установки) арт. № 13596XXX / 13597XXX / 97407XXX / 98860000

Корпус может монтироваться, согласно условиям строительства, примеры монтажа см. на стр. 91 и 92.

- A** варианты установки
- B** Установка на стене. Здесь с гибким распорным держателем, благодаря винтам 10.
- C** Монтаж на системе стоек.
- D** Установка на сборных монтажных плитах или сборных кабинах.
- E** монтаж в кирпичную стену
- F** Установка с помощью комплекта монтажных шин 96615000.

Примеры монтажа с указанием размеров и размеры трубопровода см. на стр. 96.
Пояснение к используемым символам см. на стр. 39 и 40.

Подсказка по монтажу

Для завинчивания фитингов закрепите iBox с помощью куска трубы в тисках.

Промывка

Промывайте все установленное оборудование согласно DIN 1988/EN 1717. Стрелки на промывочном блоке показывают, какой вход связан с отводом, например холодная вода с нижним отводом, а горячая вода – с верхним отводом. Если требуется только один отвод, то после первой промывки промывочный блок необходимо повернуть на 90°.

iBox в комбинации со впуском ванны Exafill со сливной и переливной гарнитурой (см. стр. 95)

Технические данные

Рабочее давление:	не более. 1 МПа
Рекомендуемое рабочее давление:	0,1 - 0,5 МПа
Давление:	1,6 МПа
(1 МПа = 10 bar = 147 PSI)	
Температура горячей воды:	не более. 80 °C
Рекомендуемая темп. гор. воды:	65 °C
Размеры подключения:	G 3/4"
Подключение:	холодная справа
горячая слева	
Свободное истечение при 0,3 МПа:	
Смеситель ванны Отвод ванны:	31 л/мин
Смеситель ванны Отвод душа:	24 л/мин
Смеситель душа:	32 л/мин
Термостат:	43 л/мин
Термостат с запорным вентилем / Термостат душа с электронной кнопкой пуска-останова:	26 л/мин
Термостат с запорным и переключающим вентилем:	26 л/мин
Термостат High Flow:	58 л/мин
iControl:	30 л/мин
iControl mobile:	37 л/мин



Термостат (см. стр. 118, 120, 126)



High Flow
Термостат High Flow (см. стр. 128 - 146)



Термостат с запорным вентилем (см. стр. 102, 104, 106, 112, 122)

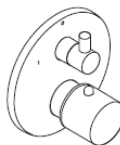

Термостат с запорным и переключающим вентилем (см. стр. 98, 114, 116, 124)

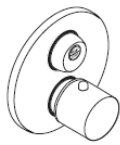

Термостат душа с электронной кнопкой пуска-останова (см. стр. 112)

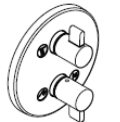

iControl
Запорный и переключающий вентиль (см. стр. 144)



iControl mobile
Запорный и переключающий вентиль (см. стр. 146)

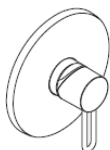

Смеситель душа (см. стр. 102, 104, 106, 112, 122)



Смеситель ванны (см. стр. 98, 100, 114, 116)



DVGW
Смеситель ванны со встроенным комбинированным предохранителем (см. стр. 96)
У комбинированного предохранителя при повреждении может вытекать вода!

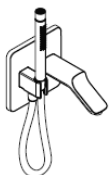

Водозабор (см. стр. 100)

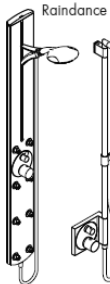

Raindance Duschpaneel (см. стр. 106, 108)

Raindance Showerpipe (см. стр. 110)

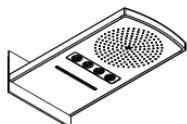

Raindance Rainfall (см. стр. 140)

	<p>середина ванны / Середина душевой ванны</p>		<p>Скрытый вентиль</p>
	<p>Размер Y = середина дуги подключения шланга, деленная на 2 (или подогнать по растр плитки).</p>	 Quattro	<p>Четырехходовой переключатель Quattro</p>
	<p>Теплая вода</p>	 Trio	<p>Трехходовой запорный и переключающий вентиль Trio Universal</p>
	<p>Холодная вода</p>		<p>Водозабор</p>
	<p>Гарантированное функционирование при показателях свыше *.</p>		<p>Неужный выход необходимо уплотнить с помощью заглушки. (DN 20 3/4")</p>
	<p>В этой области требуется укрепление стены.</p>		<p>Слив должен иметь производительность более 50 л/мин.</p>
	<p>Возможно использование только одного потребителя, не двух одновременно.</p>	 Raindrain	<p>Слив</p>
	<p>Водопроводы для боковых душей прикладывайте под наклоном.</p>	 Exafill	<p>ИВох в комбинации со впуском ванны Exafill со сливной и переливной гарнитурой (см. стр. 95)</p>

Csőszereelés

Az iBox szimmetrikus rotációjú belső szerelékével együtt univerzálisan – vízszintesen és függőlegesen egyaránt – elhelyezhető. A biztonsági szerelvényt ellátott kádcsaptelep kivételével, itt csak a függőleges beépítés lehetséges.

Mivel a működő részek meghibásodásakor víz kerülhet az iBox-ra, ezért az iBox-ot a kád fölé kell felszerelni, hogy a kifolyó víz a kádba folyhasson!

Az iBox kádhoz és tusolóhoz egyaránt alkalmas. Egykaros kádcsaptelep esetében az alsó kiállás az elsődleges. Zuhanycsaptelep szerelése esetén a használaton kívüli kiállást vakdugóval kell lezárni.

Az alaptestet úgy szereljük be, hogy a melegvíz csatlakozása bal oldalra, míg a hidegvíz csatlakozása jobb oldalra kerüljön.

Beépítési mélység: 80 – 108 mm
Hosszabbítás 25 mm cikkszám 13595000
Hosszabító készlet 22 mm (kis beépítési mélység esetén) cikkszám 13596XXX / 13597XXX / 97407XXX / 98860000

Az alaptestet az építészeti adottságoknak megfelelően szereljük be. A szerelési példákat lásd a 91. és a 92. oldalon.

- A** Szerelés közvetlenül a falra.
- B** Távtartó szerkezetre való szerelés.
- C** Tartórendszerre szerelés.
- D** Készház elemre vagy előkészített elemre szerelés.
- E** Szerelés falba süllyesztve.
- F** Szerelés szerelősín-szettel 96615000.

Felszerelési példák méreteikkel és vezeték-dimenzióval az 96 oldaltól kezdődően találhatóak. A használt szimbólumok magyarázata az 42 és 43 oldalon található.

Szerelési ötlet

A csatlakozó közdarabok becsavarásához - egy cső segítségével - fogjuk satuba az iBox-ot.

Átöblítés

Öblítsük át a teljes szerelvényt a DIN 1988 / EN 1717 sz. szabvány előírásainak megfelelően. Az öblítő-blokkon látható nyílak mutatják, hogy melyik beömlő vezeték melyik lefolyó vezetékhez kapcsolódik, így pl. a hidegvíz vezetéke az alsó kiálláshoz és a melegvíz vezetéke a felső kiálláshoz. Amennyiben csupán egyetlen kiállásra van szükség, az első öblítési műveletet követően forgassuk el 90°-kal az öblítő-blokkot.

iBox, valamint Exafill kádtöltő, le- és túlfolyó kombinációja (lásd a 95. oldalon)

Műszaki adatok

Üzemi nyomás:	max. 1 MPa
Ajánlott üzemi nyomás:	0,1 - 0,5 MPa
Nyomáspróba:	1,6 MPa
(1 MPa = 10 bar = 147 PSI)	
Forróvíz hőmérséklet:	max. 80 °C
Forróvíz javasolt hőmérséklete:	65 °C
Csatlakozási méret:	G ¾"
Csatlakozás:	hideg jobbra - meleg balra
Szabad átfolyás 0,3 MPa nyomás esetén:	
Kádcsaptelep Kád lefolyója:	31 l/perc
Kádcsaptelep Zuhany lefolyója:	24 l/perc
Zuhanycsaptelep:	32 l/perc
Termosztát:	43 l/perc
Termosztát elzárószeleppel / Önzáró termosztatikus zuhanycsaptelep:	26 l/perc
Termosztát elzáró- és váltószeleppel:	26 l/perc
Termosztát High Flow:	58 l/perc
iControl:	30 l/perc
iControl mobile:	37 l/perc



Termosztát (lásd a oldalon 118, 120, 126)



High Flow

Termosztát High Flow (lásd a oldalon 128 - 146)

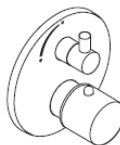

Termosztát elzárószeleppel (lásd a oldalon 102, 104, 106, 112, 122)

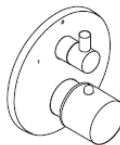

Termosztát elzáró- és váltószeleppel (lásd a oldalon 98, 114, 116, 124)



Önzáró termostatikus zuhanycsaptelep (lásd a oldalon 112)

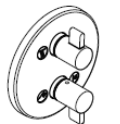

iControl Záró- és váltószelep (lásd a oldalon 144)



iControl mobile Záró- és váltószelep (lásd a oldalon 146)

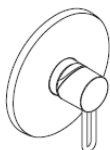

Zuhanycsaptelep (lásd a oldalon 102, 104, 106, 112, 122)



Kádcsaptelep (lásd a oldalon 98, 100, 114, 116)



DVGW Kádcsaptelep beépített biztonsági egységgel (lásd a oldalon 96)

A kombinált biztosító meghibásodásakor víz ömölhet ki!

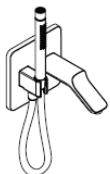

Kádbevezetés (lásd a oldalon 100)

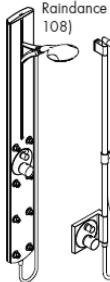





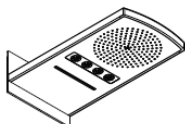









Raindance Duschpaneel (lásd a oldalon 106, 108)

Raindance Showerpipe (lásd a oldalon 110)



Raindance Rainfall (lásd a oldalon 140)

X	A kád közepe / Zuhanytálca közepe		Falsík alatti szelep
Y	Y méret = a csőcsatlakozó közepétől a kádöntő befolyócső közepéig, osztva kettővel (szükség esetén a csempe kiosztásához igazítva).		Quattro négy-utas átalakító
	Melegvíz		Trio univerzális záró- és váltószelep
	Hidegvíz		Kádbevezetés
	A • tól működik az adott funkció.		A főlöszleges kimenetet vakdugóval kell lezárni. (DN 20 3/4")
	Ezen a területen a fal megerősítésére van szükség.		A lefolyó teljesítményének 50l/percnél magasabbnak kell lenni
	Egyidejűleg csak egy fogyasztót lehet használni, két fogyasztó (zuhanyrózsa, oldalzuhanyok) egyszerre nem tud működni.		Lefolyó
	Az oldalzuhanyokhoz a vízvezetéklet lejtéssel ajánlott beszerezni.		iBox, valamint Exafill kádöntő, le- és túlfolyó kombinációja (lásd a 95. oldalon)

Raaka-asennus

Pyörsymmetrinen iBox:in peruskappale on yleiskäyttöinen, sen voi asentaa sekä pysty-, että vaakasuoraan. Poikkeuksena sellaisten ammearmatuurit, joissa on varmuuskombinaatio, tällöin vain vaakasuora asennus on mahdollinen.

Koska iBox:ista voi valua vettä toimintaosien vahingoittuessa, iBox on asennettava ammeen yläpuolelle, jotta valuva vesi pääsee valumaan ammeeseen!

iBox soveltuu sekä amme- että myös suihkuasennukseen. Lähtö 1 on tarkoitettu etupäässä yksiköksi ammesekoittimelle. Suihkuasennuksessa käyttämättä jäänyt lähtö pitää tiivistää sulkutulpalla.

Asenna peruskappale siten, että lämminvesiliitäntä tulee vasemmalle ja kylmävesiliitäntä aina oikealle puolelle. Asennussyvyys 80 mm - 108 mm.

Pidennys 25 mm tuotenumero 13595000

Pidennys 22 mm (pienemmällä asennussyvyydellä) tuotenumero 13596XXX / 13597XXX / 97407XXX / 98860000

Peruskappaleen voi asentaa rakennuksen asettamien reunaehtojen mukaisesti, katso asennusesimerkkejä sivulla 91 ja 92.

- A** Asennus seinään
- B** Asennus seinään. Tässä joustavaa etäisyydenpöytä käyttäen kaksikierteisillä 10 mm ruuveilla.
- C** Asennus kannatinjärjestelmään
- D** Asennus valmistalojen asennuslevyihin tai valmisosiin.
- E** Asennus suoraan seinään.
- F** Asennus käyttäen asennuskisko-sarjaa 96615000.

Asennusesimerkit mittoineen ja putkitietoineen löytyvät alkaen sivulta 96.

Käytettyjen merkkien selitys sivulla 45 ja 46.

Asennusvihje

Kiinnitä iBox putkenpätkän avulla ruuvipenkkiin, jotta saat kierrettyä liittokappaleet sisään.

Huuhtelu

Koko asennettu järjestelmä on huuhdeltava DIN 1988 / EN 1717 -standardin mukaisesti. Huuhtelulohkossa olevat nuolet osoittavat, mikä tulo on liitettyä mihinkin lähtöön, esim. kylmävesi lähtöön 1 ja lämminvesi lähtöön 2. Jos tarvitaan vain 1 lähtö, ensimmäisen huuhtelun jälkeen huuhtelulohkoa on kierrettävä 90°.

iBox yhdessä Exafill ammeentäyttöhana varustettuna tyhjennys- ja ylivuotovarusteilla
(katso sivu 95)

Tekniset tiedot

Käyttöpaine:	maks. 1 MPa
Suosittelut käyttöpaine:	0,1 - 0,5 MPa
Koestuspaine:	1,6 MPa
(1 MPa = 10 bar = 147 PSI)	
Kuuman veden lämpötila:	maks. 80 °C
Kuuman veden suosituslämpötila:	65 °C
Liitäntämitat:	G ¾"
Liittimet:	kylmä oikealla - kuuma vasemmalla
Vapaa läpivirtaus 0,3 MPa paineella:	
Ammesekoittaja Ammeen lähtö:	31 l/min
Ammesekoittaja Suihkon lähtö:	24 l/min
Suihkusekoittaja:	32 l/min
Termostaatti:	43 l/min
Termostaatti sulkuventtiilillä / Suihkutermostaatti elektronisella Start-Stop -painikkeella:	26 l/min
Termostaatti sulku- ja vaihtoverntiilillä:	26 l/min
Termostaatti High Flow:	58 l/min
iControl:	30 l/min
iControl mobile:	37 l/min



Termostaatti (katso sivu 118, 120, 126)



High Flow

Termostaatti High Flow (katso sivu 128 - 146)



Termostaatti sulkuventtiilillä (katso sivu 102, 104, 106, 112, 122)

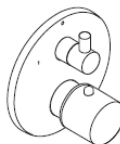

Termostaatti sulku- ja vaihtventtiilillä (katso sivu 98, 114, 116, 124)

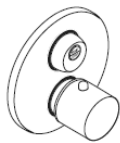

Suihkutermostaatti elektronisella Start-Stop -painikkeella (katso sivu 112)

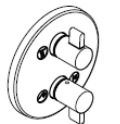

iControl Sulku- ja säätöventtiili (katso sivu 144)



iControl mobile Sulku- ja säätöventtiili (katso sivu 146)



Suihkusekoittaja (katso sivu 102, 104, 106, 112, 122)



Ammesekoittaja (katso sivu 98, 100, 114, 116)



DVGW

Ammesekoittaja integroidulla turvayhdistelmällä (katso sivu 96)

Varmistuskombinaatiosta voi, sen ollessa viallinen, valua vettä!

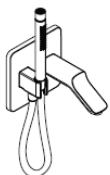

Vedentulo ammeseeseen (katso sivu 100)

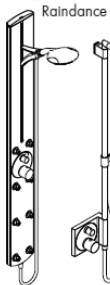





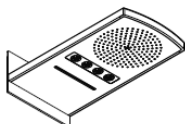







Raindance Duschpaneel (katso sivu 106, 108)

Raindance Showerpipe (katso sivu 110)



Raindance Rainfall (katso sivu 140)

X	Ammeen keskusta / Suihkualtaan keskusta		Upotettava venttiili
Y	Mitä Y = etäisyys letkunliitäntäkaaren keskeltä ammeen tuloaukon keskelle jaettuna kahdella (sovitus mahdollisesti laattaruudukkoon).	 Quattro	4-tiesäätöventtiili
	Lämmin vesi	 T r i o	Trio -sulku- ja säätöventtiili
	Kylmä vesi		Vedentulo ammeeseen
	Tämä toiminta on taattuna • alkaen.		Käyttämätön lähtöliitin on suljettava sulku- tulpalla. (DN 20 ¾")
	Tässä kohdassa seinää on vahvistettava	 > 50 l/min	Poisvirtaustehon on oltava enemmän kuin 50l/min.
	Vain yksi vedenkäyttöpiste kerrallaan on mahdollista, ei kahta samanaikaisesti.	 Raindrain	Veden poisvirtaus
	Vie sivusuihkujen syöttöputket alaspäin laskevasti.	 Exafill	iBox yhdessä Exafill ammeentäyttöhana varustettuna tyhjennys- ja ylivuotovarusteil- la (katso sivu 95)

Grundmontering

Den rotations-symmetriska grundkonstruktionen hos iBox är universellt användbar, så väl horisontellt som vertikalt. Detta gäller dock inte för monteringen av kararmatur med säkerhetskombination; här är endast vertikal monteringen möjlig.

Eftersom vatten kan tränga ut vid iBoxen om funktionsdelar är defekta så måste iBoxen monteras över karet så att det vatten som kommer ut kan rinna ner i karet!

iBox är avsedd för såväl kar- som duschinstallation. Till enhandsblandare används främst det undre avloppet. Vid installering i dusch måste man sätta en propp i det avlopp som inte behövs så att detta är tätt.

Montera grundkonstruktionen så att varmvattensanslutningen sitter till vänster och kallvattensanslutningen till höger.

Monteringsdjup 80 mm till 108 mm.

Förlängning 25 mm artikelnummer 13595000

Förlängning 22 mm (vid litet monteringsdjup) artikelnummer 13596XXX / 13597XXX / 97407XXX / 98860000

Grundkonstruktionen monteras enligt de förutsättningar som gäller på platsen, se monteringsexempel på sidor 91 och 92.

- A** Vägginstallation.
- B** Vägginstallation. Här med flexibel avståndshållare genom skruvstift storl. 10.
- C** Montering på stödsystem.
- D** Installation på monteringsplattor till färdighus eller färdigsektioner.
- E** Installation direkt i väggen.
- F** Installation med monteringskneset 96615000.

Du hittar installationsexempel med uppgifter om mått och ledningsdimensioner från sidan 96.

Förklaringen till de använda symbolerna på sidan 48 och 49.

Monteringstips

Sätt fast iBox i skruvvingen med hjälp av ett rör när anslutningsstycken ska skruvas in.

Spola

Spola igenom hela installationen enligt DIN 1988 / EN 17 17. Pilarna på spolblocket visar vilken inkommande ledning som är ansluten till vilket avlopp, t.ex. kallvatten till det nedre avloppet och varmvatten till det övre. Om det bar behövs ett avlopp måste spolblocket vridas 90° efter första spolningen.

iBox i kombination med ett Exafill karinlopp med från- och överrinningsset (se sidan 95)

Tekniska data

Driftstryck:	max. 1 MPa
Rek. driftstryck:	0,1 - 0,5 MPa
Tryck vid provtryckning: (1 MPa = 10 bar = 147 PSI)	1,6 MPa
Varmvattentemperatur:	max. 80 °C
Rek. varmvattentemp.:	65 °C
Anslutningsmått:	G ¾"
Anslutningar:	kallt höger - varmt vänster
Fri genomströmning vid 0,3 MPa:	
Karblandare Avlopp kar:	31 l/min
Karblandare Avlopp dusch:	24 l/min
Duschblandare:	32 l/min
Termostat:	43 l/min
Termostat med spärrventil / Duschtermostat med elektronisk Start-Stop-knapp:	26 l/min
Termostat med spärr- och omställningsventil:	26 l/min
Termostat High Flow:	58 l/min
iControl:	30 l/min
iControl mobile:	37 l/min



Termostat (se sidan 118, 120, 126)



High Flow

Termostat High Flow (se sidan 128 - 146)

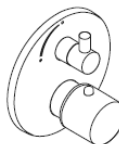

Termostat med spärrventil (se sidan 102, 104, 106, 112, 122)

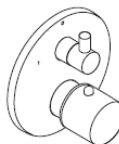

Termostat med spärr- och omställningsventil (se sidan 98, 114, 116, 124)



Duschtermostat med elektronisk Start-Stop-knapp (se sidan 112)

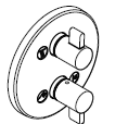

iControl Avstängningsventil och omkastare (se sidan 144)



iControl mobile Avstängningsventil och omkastare (se sidan 146)



Duschblandare (se sidan 102, 104, 106, 112, 122)



Karblandare (se sidan 98, 100, 114, 116)



DVGW

Karblandare med integrerad säkerhetskombination (se sidan 96)

Vid säkerhetskombinationen kan vatten tränga ut vid en defekt!

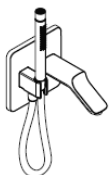

Badkarskran (se sidan 100)

Raindance Duschpanel (se sidan 106, 108)

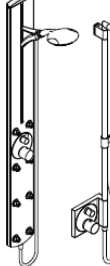

Raindance Showerpipe (se sidan 110)

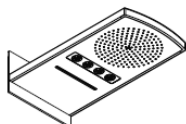

Raindance Rainfall (se sidan 140)

- X** Mitt på badkar / Mitten av duschkaret  Invändig ventil
- Y** Mått Y = mitten av slanganslutningskrök till mitten av karinlopp delat med två (anpassa eventuellt till kakelmönstret).  Quattro Fyrvägsomkastare
-  Varmvatten  Trio Universell avstängningsventil och omkastare
-  Kallvatten  Badkarskran
-  Från • garanteras funktionen.  Det utlopp som inte behövs måste tätas med en blindstopp. (DN 20 3/4")
-  Šioje zonoje būtinas sienos sutvirtinimas  Avloppet måste klara mer än 50 l/min.
-  Endast en enhet möjlig, inte två samtidigt.  Raindrain Avlopp
-  Drag vattenledningar till sidoduschar med fall.  Exafill i kombination med ett Exafill karinlopp med från- och överrinningsset (se sidan 95)

Bazinis montavimas

Simetriškai besisukantis iBox pagrindą galima įstatyti tiek horizontaliai, tiek vertikaliai. Kai įrengiama vonios armatūra su apsauginiu rinkiniu, įmontuoti galima tik vertikaliai.

„iBox“ visada montuokite virš vonios, kad atsiradus problemai su funkcinėmis dalimis, vanduo galėtų į ją nubėgti!

iBox tinka tiek voniai, tiek ir dušui. Viena ranka valdomuose maišytuvuose pirmenybė teikiama apatiniam išvadui. Įrengdami dušą, nereikalingą išvadą sandariai uždenkite kaiščiu.

Pagrindą sumontuokite taip, kad karšto vandens jungtis būtų kairėje, o šalto - dešinėje.

Montavimo gylis: nuo 80 mm iki 108 mm.

Ilgiklis 25 mm Art.Nr. 13595000

Ilgiklis 22 mm, esant nepakankamam sienos gyliui. Art. Nr. 13596XXX / 13597XXX / 97407XXX / 98860000

Pagrindą galite sumontuoti pagal vietos sąlygas, montavimo pavyzdžiai pateikti 91 ir 92 psl.

A Montavimas į sieną.

B Montavimas į sieną su specialiais reguliuojamais 10 mm varžtais.

C Montavimas prie laikančios sistemos.

D Montavimas prie namo montavimo plokščių arba elementų.

E Montavimas į sieną.

F Montavimas su montavimo rinkiniu 96615000.

Įrengimo pavyzdžiai su nurodytais matmenimis ir vamzdžio dydžiais pateikti 96 puslapyje.

Vartojamų simbolių paaiškinimai pateikti 51 ir 52 puslapiuose.

Montavimo patarimas

Norėdami įsukti jungiamuosius elementus, vamzdžius įtvirtinkite iBox spaustuvoje.

Išplaukite

Pagal DIN 1988 / EN 1717 išplaukite visą įrangą. Rodyklės ant plaunamojo bloko rodo, kuriuos įvadus ir išvadų vamzdžius reikia sujungti tarpusavyje, pavyzdžiui, šalto vandens įvadą su apatiniu išvadu, o karšto vandens įvadą su viršutiniu išvadu. Jei reikalingas tik vienas išvadas, po pirmojo plovimo pasukite plaunamąjį bloką 90°.

iBox kartu su Exafill vonios čiaupu ir išleidimo bei apsauginės angos rinkiniais (žr. psl. 95)**Techniniai duomenys**

Darbinis slėgis:	ne daugiau kaip 1 MPa
Rekomenduojamas slėgis:	0,1 - 0,5 MPa
Bandomasis slėgis:	1,6 MPa
(1 MPa = 10 barų = 147 PSI)	
Karšto vandens temperatūra:	ne daugiau kaip 80 °C
Rekomenduojama karšto vandens temperatūra:	65 °C
Atstumas tarp centrų:	G ¾"
Prijungimas:	Šaltas vanduo dešinėje, karštas - kairėje
Laisvas vandens pralaidumas esant 0,3 MPa slėgiui:	
maišytuvai voniai Vonios išleidimas:	31 l/min
maišytuvai voniai Dušo išleidimas:	24 l/min
dušo maišytuvai:	32 l/min
Termostatas:	43 l/min
Termostatas su uždarymo vožtuvu / Termostatas dušui su elektronine „Start-Stop“ funkcija:	26 l/min
Termostatas su uždarymo vožtuvu ir skirstytuvu:	26 l/min
Termostatas High Flow:	58 l/min
iControl:	30 l/min
iControl mobile:	37 l/min



Termostatas (žr. psl. 118, 120, 126)



High Flow
Termostatas High Flow (žr. psl. 128 - 146)



Termostatas su uždarymo vožtuvu (žr. psl. 102, 104, 106, 112, 122)

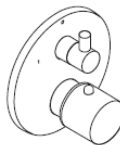

Termostatas su uždarymo vožtuvu ir skirstytuvu (žr. psl. 98, 114, 116, 124)



Termostatas dušui su elektronine "Start-Stop" funkcija (žr. psl. 112)

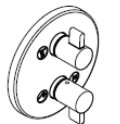

iControl
Užtvarinis ir perjungimo vožtuvas (žr. psl. 144)



iControl mobile
Užtvarinis ir perjungimo vožtuvas (žr. psl. 146)

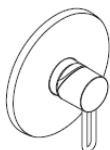

dušo maišytuvai (žr. psl. 102, 104, 106, 112, 122)



maišytuvai voniai (žr. psl. 98, 100, 114, 116)



DVGW
maišytuvai voniai su integruota apsaugos sistema (žr. psl. 96)
Įvykus gedimui, prieš apsauginio rinkinio gali ištekėti vanduo!

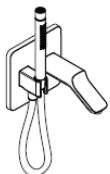

Vonios įeiga (žr. psl. 100)

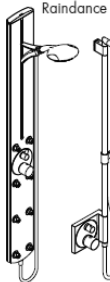



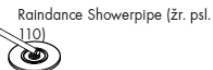



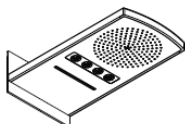







Raindance Duschpaneel (žr. psl. 106, 108)



Raindance Showerpipe (žr. psl. 110)



Raindance Rainfall (žr. psl. 140)

X	Vonios vidurys / Dušo padėklo centras		Potinkinis uždarymo vožtuvas
Y	Matmuo Y = atstumas nuo dušo žarnos jungties centro iki čiaupo centro, padalintas iš 2 (jei įmanoma, taikykite prie plytelių).	 Quattro	„Quattro“ 4-krypčių perjungimas
	Šiltas vanduo	 T r i o	Užtvartinis ir perjungimo vožtuvas „Trio Universal“
	Šaltas vanduo		Vonios įeiga
	Nuo • funkcionavimas garantuotas		Nenaudojamą išėjimą užaklinti. (DN 20 3/4")
	Šioje zonoje būtinas sienos sutvirtinimas	 > 50 l/min	Nutekėjimo našumas turi būti ne mažesnis 50 l/min
	Vienu metu galima tik viena funkcija.	 Raindrain	Nutekėjimas
	Privesti vamzdžius šoniniams purkštukams.	 Exafill	iBox kartu su Exafill vonios čiaupu ir išleidimo bei apsauginės angos rinkiniais (žr. psl. 95)

Priprema montaža

Rotacijsko simetrično tijelo jedinice iBox je univerzalno primjenjivo, kako horizontalno tako i vertikalno. Iznimku predstavlja montaža armatura za kade sa sigurnosnom kombinacijom, kod koje je moguća samo vertikalna ugradnja.

Budući da kod kvara pojedinih dijelova iz iBox-a može otjecati voda, iBox je potrebno instalirati iznad kade kako bi voda mogla otjecati u kadu!

iBox je pogodan za ugradnju na tuš kade i kade. Kod jednoručnih miješalica za kade prioritetan je donji izlaz. Kod instalacije na tuš kadi izlaz koji se ne koristi treba zabrtviti čepom.

Montirajte tijelo tako da se priključak tople vode nalazi na lijevoj, a hladne na desnoj strani.

Dubina ugradnje 80 - 108 mm.

Produljenje 25 mm br. Proizvoda 13595000

Produljenje 22 mm (kod manje dubine ugradnje) br.

Proizvoda 13596XXX / 13597XXX / 97407XXX / 98860000

Tijelo se može montirati u skladu s uvjetima koji vladaju na mjestu postavljanja, primjeri montaže mogu se naći na stranicama 91 i 92.

- A** Direktna instalacija u zid.
- B** Direktna instalacija u zid sa 10 mm podesivim vijcima
- C** Montaža na sustav nosača.
- D** Instalacija na gotove montažne ploče ili gotove ćelije.
- E** Instalacija u zid od cigle.
- F** Instalacija sa setom instalacijskih udlaga 96615000.

Primjeri instalacija s veličinama i dimenzijama vodova mogu se naći od stranice 96 nadalje.

Pojašnjenje korištenih simbola nalazi se na stranici 54 i 55.

Savjet u vezi montaže

Za uvrtnje priključnih elemenata iBox treba zategnuti u stegu uz pomoć komada cijevi.

Ispiranje

Kompletnu instalaciju treba isprati sukladno DIN 1988 / EN 1717. Streljce na bloku prikazuju koji je dovod spojen s kojim odvodom, npr. hladna voda s donjim, a topla s gornjim odvodom. Ako je potreban samo jedan odvod, onda se nakon prvog ispiranja blok mora zakrenuti za 90°.

iBox u kombinaciji s Exafill ispustom u kadu s odvodnom i preljevnom garniturom (pogledaj stranicu 95)

Tehnički podaci

Najveći dopušteni tlak:	tlak 1 MPa
Preporučeni tlak:	0,1 - 0,5 MPa
Probni tlak:	1,6 MPa
(1 MPa = 10 bar = 147 PSI)	
Temperatura vruće vode:	tlak 80 °C
Preporučena temperatura vruće vode:	65 °C
Razmak od sredine:	G ¾"
Spojevi:	hladna desno - topla lijevo
Slobodan protok na 0,3 MPa:	
Mješalica za kadu Ogranak kada:	31 l/min
Mješalica za kadu Ogranak tuš:	24 l/min
Mješalica tuša:	32 l/min
Termostat:	43 l/min
Termostat sa izolacijskim ventilom / Termostat tuša sa elektronskom Start-stop tipkom:	26 l/min
Termostat sa ventilom za zatvaranje i ventilom selektora:	26 l/min
Termostat High Flow:	58 l/min
iControl:	30 l/min
iControl mobile:	37 l/min



Termostat (pogledaj stranicu 118, 120, 126)



High Flow
Termostat High Flow (pogledaj stranicu 128 - 146)

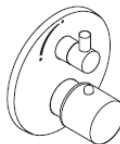

Termostat sa izolacijskim ventilom (pogledaj stranicu 102, 104, 106, 112, 122)

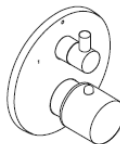

Termostat sa ventilom za zatvaranje i ventilom selektora (pogledaj stranicu 98, 114, 116, 124)



Termostat tuša sa elektronskom Start-stop tipkom (pogledaj stranicu 112)

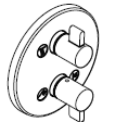

iControl
Ventil za zatvaranje i ventil selektora (pogledaj stranicu 144)



iControl mobile
Ventil za zatvaranje i ventil selektora (pogledaj stranicu 146)

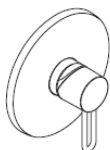

Mješalica tuša (pogledaj stranicu 102, 104, 106, 112, 122)



Mješalica za kadu (pogledaj stranicu 98, 100, 114, 116)



DVGW
Mješalica za kadu sa ugrađenim sigurnosnim sustavom (pogledaj stranicu 96)
Kod sigurnosne kombinacije u slučaju kvara može doći do istjecanja vode!

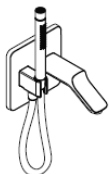

Ispust u kadu (pogledaj stranicu 100)

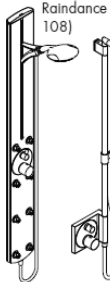





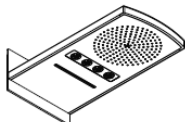









Raindance Duschpaneel (pogledaj stranicu 106, 108)

Raindance Showerpipe (pogledaj stranicu 110)



Raindance Rainfall (pogledaj stranicu 140)

X	Sredina kade / Sredina tuš-kada		Podžbukni ventil
Y	Mjera Y = sredina priključka crijeva do sredine filtera kade podijeljeno sa 2 (eventualno prilagoditi rasteru pločica)	 Quattro	Quattro četverostruki preusmjernič
	topla voda	 T r i o	Trio Universal ventil za zatvaranje i ventil selektora
	hladna voda		Ispust u kadu
	Zajamčena funkcija od • naviše		Potrebno je ostaviti zatvoren izlaz koji se ne koristi (DN 20 3/4")
	U ovom je području potrebno ojačanje zida.	 > 50 l/min	Protok vode mora biti veći od 50 l/min.
	Moguće je koristiti samo jedno trošilo, nikako dva istovremeno!	 Raindrain	Odvod
	Položite vodovodne cijevi za bočni tuš nagibom	 Exafill	iBox u kombinaciji s Exafill Ispustom u kadu s odvodnom i prelijevnom garniturom (pogledaj stranicu 95)

Ham montaj

iBox'un rotasyon simetrik ana gövdesi yatay veya dikey şekilde çok amaçlı kullanılabilir. İstisna: Emniyet kombinasyonlu batarya armatürünün montajı sırasında sadece dikey montaj mümkündür.

Fonksiyon parçalarının arızalanması durumunda iBox'tan su çıkabileceği için, dışarı çıkan suyun küvete akabilmesi için iBox küvetin üzerine monte edilmelidir.

Ibox hem küvet hem de duş tesisatı için uygundur. Tek elli küvet tipi bataryalarda alt çıkış önceliklidir. Duş testi atında, kullanılmayan çıkış bir tapayla izole edilmelidir.

Ana gövdeyi, sıcak su bağlantısı solda ve soğuk su bağlantısı sağda olacak şekilde takın.
Montaj derinliği 80 mm ila 108 mm.
Uzatma 25 mm Ürün kodu 13595000
Uzatma 22 mm (montaj derinliği düşükken) Ürün kodu 13596XXX / 13597XXX / 97407XXX / 98860000

Ana gövde yapısal koşullara uygun şekilde takılabilir, Montaj örneği Bkz. Sayfa 91 ve 92.

- A** Duvara direkt montaj
- B** Duvara direkt montaj. Burada, esnek mesafe tutucuları ile 10'lu sıkma vidaları kullanılarak.
- C** Taşıyıcı sistem üzerine montaj.
- D** Hazır ev montaj plakalarına veya hazır hücelere kurulum.
- E** Tuğla duvar Montajı
- F** Montaj rayı setiyle montaj 96615000.

Ölçü verileri ve hat boyutlandırıcılı tesisat örnekleri Sayfa 96 itibarıyla bulunabilir.
Kullanılan simgelerin açıklaması Sayfa 57 ve 58'de.

Montaj önerisi

Bağlantı parçalarını vidalamak için, iBox'u bir boru parçasıyla mengeneyle sabitleyin.

Yıkama

Tüm tesisatı DIN 1988 / EN 1717'ye göre yıkayın. Yıkama bloğundaki oklar hangi beslemenin hangi çıkış hattına bağlı olduğunu gösterir, örn; soğuk su alt çıkışa ve sıcak su üst çıkışa. Sadece bir çıkış kullanılıyorsa, birinci yıkama işleminden sonra yıkama bloğu 90° döndürülmelidir.

Çıkış ve taşma aksesuarlı bir Exafill batarya girişiyile bağlantılı iBox (Bakınız sayfa 95)**Teknik bilgiler**

İşletme basıncı:	azami 1 MPa
Tavsiye edilen işletme basıncı:	0,1 - 0,5 MPa
Kontrol basıncı:	1,6 MPa
(1 MPa = 10 bar = 147 PSI)	
Sıcak su sıcaklığı:	azami 80 °C
Tavsiye edilen su ısı:	65 °C
Bağlantı ölçüleri:	G ¾"
Bağlantılar:	soğuk sağ - sıcak sol
0,3 MPa serbest akış:	
Küvet miks bataryası Tekne çıkışı:	31 l/dak
Küvet miks bataryası Su püskürtücü çıkışı:	24 l/dak
Duş miks bataryası:	32 l/dak
Termostat:	43 l/dak
Kesme valfli termostat / Elektronik Start-Stop tuşlu duş termostat:	26 l/dak
Kesme ve divertör valfli termostat:	26 l/dak
Termostat High Flow:	58 l/dak
iControl:	30 l/dak
iControl mobile:	37 l/dak



Termostat (Bakınız sayfa 118, 120, 126)



High Flow

Termostat High Flow (Bakınız sayfa 128 - 146)



Kesme valfli termostat (Bakınız sayfa 102, 104, 106, 112, 122)

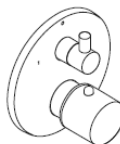

Kesme ve divertör valfli termostat (Bakınız sayfa 98, 114, 116, 124)



Elektronik Start-Stop tuşlu duş termostadı (Bakınız sayfa 112)

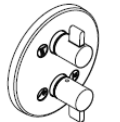

iControl Kapatma ve değiştirme valfi (Bakınız sayfa 144)



iControl mobile Kapatma ve değiştirme valfi (Bakınız sayfa 146)

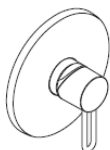

Duş miks bataryası (Bakınız sayfa 102, 104, 106, 112, 122)



Küvet miks bataryası (Bakınız sayfa 98, 100, 114, 116)



DVGW

Entegre emniyet kombinasyonlu küvet miks bataryası (Bakınız sayfa 96)

Bir arıza durumunda, emniyet kombinasyonundan su çıkabilir!

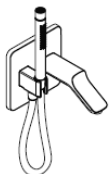

Küvet su girişi (Bakınız sayfa 100)

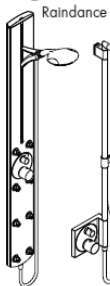





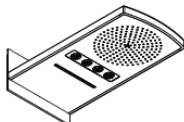









Raindance Duschpaneel (Bakınız sayfa 106, 108)

Raindance Showerpipe (Bakınız sayfa 110)



Raindance Rainfall (Bakınız sayfa 140)

X	Küvetin ortası / Duş küvetinin ortası		Sıva altı valfi
Y	Y = Hortum bağlantı kavisinin ortasından küvet girişinin ortası arasındaki ölçü 2'ye bölünür (gerekirse fayans bölümlerine adapte edin).	 Quattro	Quattro dört yönlü değiştirme
	Sıcak su	 T r i o	Trio üniversal kapatma ve değiştirme valfi
	Soğuk su		Küvet su girişi
	• 'den itibaren fonksiyon garanti edilmiştir.		Kullanılmayan çıkış bir kör tapayla izole edilmelidir. (DN 20 3/4")
	Bu alanda duvarın kalınlaştırılması gereklidir.		Akış kapasitesi 50 l/dak üzerinde olmalıdır.
	Sadece bir tüketici mümkündür, aynı anda iki tüketici mümkün değildir.	 Raindrain	Akış
	Yan duşların su hatlarını eğimli şekilde döşeyin.	 Exafill	Çıkış ve taşma aksesuarlı bir Exafill batarya girişiyle bağlantılı iBox (Bakınız sayfa 95)

Instalare brută

Partea principală simetric-rotațională a iBox-ului poate fi introdusă oricum, atât orizontal cât și vertical. Excepție la montarea robinetului căzii cu combinația de protecție, în acest caz este posibilă numai montarea pe verticală.

Din cauza posibilității de defectare a componentelor din iBox, montați instalația iBox deasupra căzii pentru ca apa cursă să se evacueze prin cadă.

Cutia iBox este corespunzătoare atât pentru instalarea cadelor cât și a dușurilor. În cazul amestecătorului monomanual pentru cadă, este prioritară ieșirea inferioară. La instalarea dușului ieșirea nefolosită trebuie etanșată cu o garnitură de etanșare.

Corpul de bază este astfel construit încât racordul pentru apa caldă se află în partea stângă, iar cel pentru apa rece, în dreapta.

Adâncime de montare 80 - 108 mm

Prelungitor 25 mm Nr. produs 13595000

Prelungitor 22 mm (în cazul montării la adâncime mică)

Nr. produs 13596XXX / 13597XXX / 97407XXX / 98860000

Corpul de bază se poate monta în funcție de condițiile existente, ca exemplu de montare, vedeți pagina 91 și 92.

A Montare pe perete.

B Montare pe perete. Cu distanțieri flexibili și țije filetate de 10 mm cu diblu.

C Montare pe sistem de susținere.

D Instalare pe plăci de montare în case prefabricate sau în compartimente prefabricate.

E Montare direct pe perete.

F Montare cu set de șine de montare 96615000.

Exemplele de montaj cu specificații referitoare la dimensiuni și capacități se găsesc începând de la pagina 96. Explicațiile simbolurilor utilizate se găsesc la paginile 60 și 61.

Indicații pentru montaj

Pentru înșurubarea piesei de racordare, cutia iBox este prevăzută cu o piesă tubulară strânsă în locul filetat.

Clătire

Toată instalația se spală în conformitate cu prevederile DIN 1988 / EN 1717. Săgețile de pe blocul de spălare, arată cum se face racordarea la conductele de ieșire, spre ex. apa rece la ieșirea inferioară și apa caldă la ieșirea superioară. În cazul în care este utilizată numai o singură ieșire, blocul de spălare trebuie rotit cu 90° după prima spălare.

Cutie iBox în combinație cu Exafill pe intrarea în cadă, cu un set pentru evacuare și deversare. (vezi pag. 95)

Date tehnice

Presiune de funcționare:	max. 1 MPa
Presiune de funcționare recomandată:	0,1 - 0,5 MPa
Presiune de verificare:	1,6 MPa
(1 MPa = 10 bar = 147 PSI)	
Temperatura apei calde:	max. 80 °C
Temperatura recomandată a apei calde:	65 °C
Interax racorduri:	G 3/4"
Racorduri:	rece - dreapta / cald - stânga
Debit cu curgere liberă la 0,3 MPa:	
baterie pentru cadă de baie Orificiu de scurgere vană:	31 l/min
baterie pentru cadă de baie Orificiu de scurgere duș:	24 l/min
Baterie duș:	32 l/min
Termostat:	43 l/min
Termostat cu ventil de închidere / Robinet termostatic cu întrerupător electric:	26 l/min
Termostat cu ventil de închidere și valvă comutator:	26 l/min
Termostat High Flow:	58 l/min
iControl:	30 l/min
iControl mobile:	37 l/min



Termostat (vezi pag. 118, 120, 126)



High Flow

Termostat High Flow (vezi pag. 128 - 146)



Termostat cu ventil de închidere (vezi pag. 102, 104, 106, 112, 122)

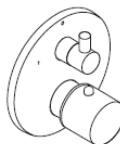

Termostat cu ventil de închidere și valvă comutator (vezi pag. 98, 114, 116, 124)

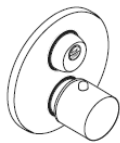

Robinet termostatic cu întrerupător electric (vezi pag. 112)

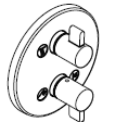

iControl Valvă de închidere și de inversare (vezi pag. 144)



iControl mobile Valvă de închidere și de inversare (vezi pag. 146)

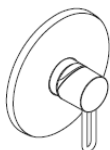

Baterie duș (vezi pag. 102, 104, 106, 112, 122)



baterie pentru cadă de baie (vezi pag. 98, 100, 114, 116)



DVGW

Baterie pentru cadă de baie cu combinație de siguranță integrată (vezi pag. 96)

Cu ajutorul combinației de protecție, în cazul unui defect, apa poate fi evacuată!

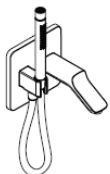

Gură de admisiune (vezi pag. 100)

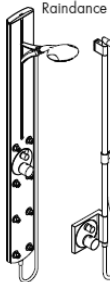





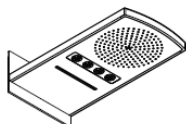

Raindance Duschpaneel (vezi pag. 106, 108)

Raindance Showerpipe (vezi pag. 110)



Raindance Rainfall (vezi pag. 140)

- X** Cadă de baie în mijloc / În mijlocul căzii de duș  Ventil montat sub tencuială
- Y** Dimensiune Y = distanța între mijlocul racordului pentru furtună și intrare cadă împărțită la doi (eventual potrivit la suprafața tencuiei).  **Quattro** Quattro valvă de inversare cu patru căi
-  Apă caldă  Trio valvă de închidere și de inversare universală **T r i o**
-  Apă rece  Gură de admisiune
-  Începând de la • funcționarea este garantată.  Racordurile neutilizate trebuie acoperite cu dop etanș. (DN 20 ¾")
-  În această zonă este nevoie de întărirea peretelui.  Capacitatea de evacuare trebuie să fie mai mare de 50 l/min.
-  Se poate conecta numai un singur consumator, nu se pot conecta doi în același timp.  **Raindrain** Deversor
-  Montați conductele de apă înclinate (în cădere) pentru dușurile laterale.  **Exafill** Cutie iBox în combinație cu Exafill pe intrarea în cadă, cu un set pentru evacuare și deversare. (vezi pag. 95)

Εγκατάσταση

Το συμμετρικό σώμα περιστροφής του iBox μπορεί να χρησιμοποιηθεί παντού, οριζόντια και κατακόρυφα. Εξαιρείται η συναρμολόγηση της μπαταρίας μπανιέρας με συνδυασμό ασφαλείας, εδώ είναι εφικτή μόνο η κατακόρυφη εγκατάσταση.

Σε περίπτωση βλάβης των λειτουργικών τμημάτων, μπορεί να εξέρχεται νερό από το iBox, και θα πρέπει η μονάδα iBox να συναρμολογηθεί πάνω από την μπανιέρα, προκειμένου το εξερχόμενο νερό να ρέει μέσα στην μπανιέρα στην περίπτωση αυτή.

Το iBox είναι κατάλληλο για εγκατάσταση τόσο σε μπανιέρες όσο και σε ντουζιέρες. Σε αναμικτήρες μπανιέρας με μια λαβή προτεραιότητα έχει η κάτω εξαγωγή. Σε εγκατάσταση σε ντουζιέρες η εξαγωγή που δεν θα χρησιμοποιείται πρέπει να ταπώνεται με τάπα.

Τοποθετήστε τη βασική εγκατάσταση έτσι ώστε η σύνδεση ζεστού νερού να βρίσκεται αριστερά και του ψυχρού δεξιά.

Βάθος τοποθέτησης 80 -108 mm.

Επιμήκυνση 25 mm αρ. είδους 13595000

Σωλήνας επιμήκυνσης 22 mm (σε μειωμένο βάθος τοποθέτησης) αρ. είδους 13596XXX / 13597XXX / 97407XXX / 98860000

Η βασική εγκατάσταση μπορεί να τοποθετηθεί σύμφωνα με τα δεδομένα του χώρου, παραδείγματα εγκατάστασης βλέπε σελίδα 91 και 92.

A Επίτοιχη τοποθέτηση

B Επίτοιχη εγκατάσταση. Χρησιμοποιήστε 10άρες βίδες -καρφιά με εύκαμπτα στηρίγματα.

C Συναρμολόγηση επί φέροντος συστήματος.

D Εγκατάσταση σε πλάκες συναρμολόγησης προκατασκευασμένων οικιών ή προκατασκευασμένες κυψέλες.

E Εγκατάσταση απευθείας στον τοίχο

F Εγκατάσταση με σετ σιδηροτροχιών συναρμολόγησης 96615000.

Παραδείγματα εγκατάστασης με διαστάσεις και διαστασιολόγηση των σωλήνων θα βρείτε από τη σελίδα 96.

Επεξήγηση των χρησιμοποιούμενων εικονιδίων θα βρείτε στη σελίδα 63 και 64.

Συμβουλή για την εγκατάσταση

Για να βιδώσετε τεμάχια σύνδεσης, σφίξτε το iBox με ένα τεμάχιο σωλήνα στη μέγγενη.

Καθαρισμός

Όλη η εγκατάσταση πρέπει να ξεπλυθεί σύμφωνα με το DIN 1988 / EN 1717. Τα βέλη επάνω στο μπλοκ δείχνουν ποια παροχή είναι συνδεδεμένη με τον αντίστοιχο σωλήνα εξαγωγής, π. χ. το κρύο νερό με την κάτω εξαγωγή και το ζεστό νερό με την άνω εξαγωγή. Αν χρειαστεί μόνο μία εξαγωγή, μετά την πρώτη πλύση θα πρέπει να περιστραφεί το μπλοκ κατά 90°.

iBox σε συνδυασμό με είσοδο νερού μπανιέρας Exacfill με απορροή και εξοπλισμό υπερχειλίσης (βλ. σελίδα 95)

Τεχνικά Χαρακτηριστικά

Λειτουργία πίεσης:	έως 1 MPa
Συνιστώμενη λειτουργία πίεσης:	0,1 - 0,5 MPa
Πίεση ελέγχου:	1,6 MPa
(1 MPa = 10 bar = 147 PSI)	
Θερμοκρασία ζεστού νερού:	έως 80 °C
Συνιστώμενη θερμοκρασία ζεστού νερού:	65 °C
Διαστάσεις σύνδεσης:	G ¾"
Συνδέσεις:	κρύο δεξιά - ζεστό αριστερά
Ελεύθερη ροή στα 0,3 MPa:	
Μπαταρία μπανιέρας Έξοδος μπανιέρας:	31 l/min
Μπαταρία μπανιέρας Έξοδος ντους:	24 l/min
Μπαταρία (μείκτης) καταιονιστήρα:	32 l/min
Θερμοστάτης:	43 l/min
Θερμοστάτης με βαλβίδα κλεισίματος / Θερμοστάτης καταιονιστήρα με ηλεκτρονικό πλήκτρο έναρξης- διακοπής (Start-Stop):	26 l/min
Θερμοστάτης με βαλβίδα κλεισίματος και εκτροπή:	26 l/min
Θερμοστάτης High Flow:	58 l/min
iControl:	30 l/min
iControl mobile:	37 l/min



Θερμοστάτης (βλ. Σελίδα 118, 120, 126)



High Flow

Θερμοστάτης High Flow (βλ. Σελίδα 128 - 146)



Θερμοστάτης με βαλβίδα κλεισίματος (βλ. Σελίδα 102, 104, 106, 112, 122)

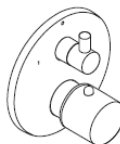

Θερμοστάτης με βαλβίδα κλεισίματος και εκτροπής (βλ. Σελίδα 98, 114, 116, 124)



Θερμοστάτης καταιονιστήρα με ηλεκτρονικό πλήκτρο έναρξης-διακοπής (Start-Stop) (βλ. Σελίδα 112)

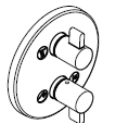

iControl Βαλβίδα κλεισίματος και εκτροπής (βλ. Σελίδα 144)



iControl mobile Βαλβίδα κλεισίματος και εκτροπής (βλ. Σελίδα 146)

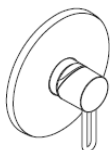

Μπαταρία (μείκτης) καταιονιστήρα (βλ. Σελίδα 102, 104, 106, 112, 122)



Μπαταρία μπανιέρας (βλ. Σελίδα 98, 100, 114, 116)



DVGW

Μπαταρία μπανιέρας με ενσωματωμένο συνδυασμό ασφαλείας (βλ. Σελίδα 96)

Στον συνδυασμό ασφαλείας εάν υπάρξει βλάβη μπορεί να υπάρξει διαρροή νερού!

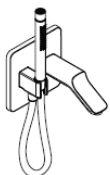

Είσοδος νερού στη μπανιέρα (βλ. Σελίδα 100)

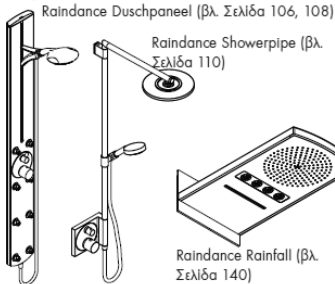

Raindance Duschraneel (βλ. Σελίδα 106, 108)

Raindance Showerpipe (βλ. Σελίδα 110)

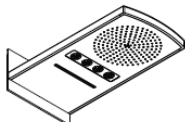

Raindance Rainfall (βλ. Σελίδα 140)

<p>X</p>	<p>Κέντρο μπανιέρας / Μέσον της ντουσιέρας</p>		<p>Χωνευτή βαλβίδα</p>
<p>Y</p>	<p>Μέγεθος X = από το μέσον του τόξου σύνδεσης του εύκαμπτου σωλήνα έως το μέσον της εισόδου της μπανιέρας, δια του 2 (ενδεχομένως να πρέπει να προσαρμοστεί στο ράστερ των πλακιδίων).</p>	 <p>Quattro</p>	<p>Quattro τετράοδης μετατροπής</p>
	<p>Ζεστό νερό</p>	 <p>T r i o</p>	<p>Trio Universal βαλβίδα κλεισίματος και εκτροπής</p>
	<p>Κρύο νερό</p>		<p>Είσοδος νερού στη μπανιέρα</p>
	<p>Αυτή η λειτουργία διασφαλίζεται από το σημείο κι έπειτα</p>		<p>Τα περίπα στόμια εξόδου πρέπει να στεγανοποιηθούν με ένα τυφλό πώμα. (DN 20 3/4")</p>
	<p>Σε αυτήν την περιοχή είναι απαραίτητη μία ενίσχυση του τοίχου.</p>	 <p>> 50 l/min</p>	<p>Η αποχευτική ικανότητα της βαλβίδας εκροής πρέπει να υπερβαίνει τα l/min.</p>
	<p>Μόνο ένας χρήστης, όχι δύο ταυτόχρονα</p>	 <p>Raindrain</p>	<p>Βαλβίδα εκροής</p>
	<p>Εγκαταστήστε τους αγωγούς νερού του καταιονιστήρα σώματος με κλίση.</p>	 <p>Exafill</p>	<p>Σε αυτήν την περιοχή είναι απαραίτητη μία ενίσχυση του τοίχου. (βλ. σελίδα 95)</p>

Surova montaža

Rotacijsko simetrično osnovno telo valja iBox je univerzalno vstavljivo, tako vodoravno kot tudi navpično. Izjema je le montaža armature za kopalno kad z zaščitnim kompletom, kjer je možna le navpična vgradnja.

Pri okvari delov iBoxa lahko pride do izteka vode, zato iBox montiramo nad kadjo. Tako lahko voda odteka v kad!

iBox je primeren tako za instalacije za kopalne kadi kot tudi za prhe. Pri enoročnih baterijah za kopalno kad ima prednost spodnji odvod. Pri instalaciji prhe je treba neuporabljen odvod zatesniti s čepom.

Monter la pièce de base pour que l'eau chaude arrive sur le côté gauche et l'eau froide sur le côté droit.
Globina vgradnje 80 do 108 mm
Podaljšek 25 mm številka artikla 13595000
Podaljšek 22 mm (če zid ni dovolj globok) številka artikla 13596XXX / 13597XXX / 97407XXX / 98860000

Osnovno telo se lahko montira ustrezno gradbenim pogojem, montažne primere glejte na strani 91 in 92.

- A** Montaža na steno
- B** Montaža na steno. Tukaj z upogljivim distančnikom in 10-milimetrskimi vijaki.
- C** Montaža na nosilnem sistemu.
- D** Instalacija na plošče montažne hiše ali montažne celice.
- E** Montaža direktno v steno
- F** Montaža s pritrdilnim kompletom 96615000.

Inštalacijske primere z navedbami mer in dimenzioniranjem cevi najdete od strani 96 dalje.

Razlage uporabljenih simbolov na straneh 66 in 67.

Nasvet za montažo

Za uvitje priključnih kosov iBox s pomočjo kosa cevi vpnite v primež.

Izpiranje

Kompletno instalacijo morate v skladu z DIN 1988/EN 1717 splakniti. Puščice na splakovalnem ventilu kažejo, kateri dovod je povezan s katerim odvodom, npr. mrzla voda s spodnjim odvodom in topla voda z zgornjim odvodom. Če je potreben le en odvod, je treba ventil po prvem splakanju obrniti za 90°.

iBox v kombinaciji z Exafill dovodom za kopalno kad z odtočno in pretočno garnituro (glejte stran 95)

Tehnični podatki

Delovni tlak:	maks. 1 MPa
Priporočeni delovni tlak:	0,1 - 0,5 MPa
Preskusni tlak:	1,6 MPa
(1 MPa = 10 bar = 147 PSI)	
Temperatura tople vode:	maks. 80°C
Priporočena temperatura tople vode:	65°C
Razdalja od sredine:	G ¾"
Priključki:	mrzla desno - topla levo
Prost pretok pri 0,3 MPa:	
Mešalna baterija za kad Odvod banje:	31 l/min
Mešalna baterija za kad Odvod prhe:	24 l/min
Mešalna baterija za prho:	32 l/min
Termostat:	43 l/min
Termostat z zapornim ventilom / Termostatska baterija za prho z elektronsko tipko „start-stop“:	26 l/min
Termostat z zapornim in preklopnim ventilom:	26 l/min
Termostat High Flow:	58 l/min
iControl:	30 l/min
iControl mobile:	37 l/min



Termostat (glejte stran 118, 120, 126)



High Flow
Termostat High Flow (glejte stran 128 - 146)



Termostat z zapornim ventilom
(glejte stran 102, 104, 106, 112, 122)

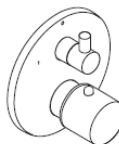

Termostat z zapornim in preklopnim ventilom (glejte stran 98, 114, 116, 124)



Termostatska baterija za prho z elektronsko tipko "start-stop" (glejte stran 112)

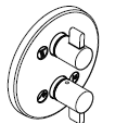

iControl
Zaporni in preklopni ventil (glejte stran 144)



iControl mobile
Zaporni in preklopni ventil (glejte stran 146)

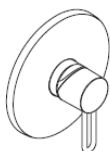

Mešalna baterija za prho (glejte stran 102, 104, 106, 112, 122)



Mešalna baterija za kad (glejte stran 98, 100, 114, 116)



DVGW
Mešalna baterija za kad z vgrajeno varnostno kombinacijo (glejte stran 96)

Iz zaščitnega kompleta lahko pri okvari odteka voda!

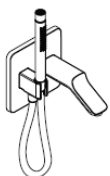

Vanni kran (glejte stran 100)

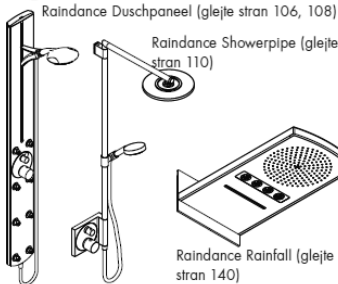





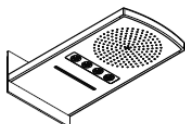









Raindance Duschpaneel (glejte stran 106, 108)

Raindance Showerpipe (glejte stran 110)



Raindance Rainfall (glejte stran 140)

X	Sredina kopalne kadi / Sredina pršne kadi		Podometni ventil
Y	Mera Y = sredina loka priključka za cev do sredine dotoka v kad deljeno z 2 (morebiti prilagoditi vzorcu ploščic)	 Quattro	Quattro ütiripotna prestavitev
	Topla voda	 T r i o	Trio Universal zaporni in preklopni ventil
	Mrzla voda		Vtok v kad
	Od • je delovanje zagotovljeno.		Izhod, ki ga ne potrebujete, zatesnite s čepom. (DN 20 ¾")
	V tem območju je potrebno ojačanje stene.	 > 50 l/min	Odtočna kapacitetamora znašati več kot 50 l/min.
	Mogoč je samo en uporabnik, ne dva istočasno.	 Raindrain	Odtok
	Položite vodovodne cevi za stranske šobe z naklonom.	 Exafill	iBox v kombinaciji z Exafill dovodom za kopalno kad z odtočno in pretočno garnituro (glejte stran 95)

Toormontaaz

Iboxi sümmeetrilise ringlusega põhikorpus on universaalselt kasutatav, nii horisontaalselt kui vertikaalselt. V.a. turvakombinatsooniga vanniarmatuuri paigaldamisel, kus on võimalik ainult vertikaalne paigaldamine.

Paigaldage iBox alati vanni kohale. Kui iBox'i osad lähevad katki, võib vesi vanni voolata!

Ibox sobib niihästi vanni kui ka duši paigaldamiseks. Ühekäe-vannisegisti puhul on alumine väljavool prioriteetne. Duši paigaldamisel tuleb mittevajalik väljavool korgiga tihendada.

Põhikorpus paigaldada nii, et sooja vee liitmik oleks vasakul ja külma vee liitmik paremal. Paigalduse sügavus 80 mm kuni 108 mm pikendus 25 mm artikli number 13595000 pikendus 22 mm (kui sein ei ole piisavalt paks). artikli number 13596XXX / 13597XXX / 97407XXX / 98860000

Põhikorpus on võimalik paigaldada vastavalt ehituslikele asjaoludele, näiteid paigaldamise kohta vt lk 91 ja 92.

- A** Seinale paigaldamine.
- B** Seinale paigaldamine. Siin reguleeritava vahehooldikuga, kasutades 10 mm tikkpolte.
- C** Kandursüsteemile paigaldamine.
- D** Paigaldamine valmismaja seinaplaatidele või lisamoodulitele
- E** Paigaldamine otse seinale.
- F** Paigaldamine kinnitussiinidega 96615000.

Paigaldusnäited koos mõõtude info ja voolikute suurustega leiata alates leheküljest 96. Kasutatud sümbolite selgitused leiata lehekülgedelt 69 ja 70.

Paigaldusnäpunäide

Ühendusdetailide sissekeeramiseks kinnitage iBox toru abil kruustangidesse.

Äravoolu süsteem

Pärast paigaldamist vastavalt standardile DIN 1988/EN 1717 läbi pesta. Loputusploklil olevad nooled näitavad, milline pealevool on millise äravoolutoruga seotud, nt külm vesi alumise äravooluga ja soe vesi ülemise äravooluga. Kui on vaja ainult ühte äravoolu, tuleb loputusplokki pärast esimest loputus 90° keerata.

iBox ühenduses ära- ja ülevoolugarnituuriga Exafilli vanni sissevooluga (vt lk 95)

Tehnilised andmed

Töörõhk	maks. 1 MPa
Soovitatav töörõhk:	0,1 - 0,5 MPa
Kontrollsurve:	1,6 MPa
(1 MPa = 10 baari = 147 PSI)	
Kuuma vee temperatuur:	maks. 80 °C
Soovitatav kuuma vee temperatuur:	65 °C
distsants keskelt:	G ¾"
ühendused:	külm paremal, kuum vasakul
Äravoolu surve	0,3 MPa
Vanni-duši segisti Vanni väljund:	31 l/min
Vanni-duši segisti Duši väljund:	24 l/min
dušisegisti:	32 l/min
Termostaat:	43 l/min
Katkestusklapiga termostaat / Duši termostaatsegisti	
elektroonse start-stop- nupuga.:	26 l/min
Katkestus- ja ümberlülitusklapiga termostaat:	26 l/min
Termostaat High Flow:	58 l/min
iControl:	30 l/min
iControl mobile:	37 l/min



Termostaat (vt lk 118, 120, 126)



High Flow

Termostaat High Flow (vt lk 128 - 146)



Katkestusklapiga termostaat (vt lk 102, 104, 106, 112, 122)

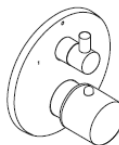

Katkestus- ja ümberlülitusklapiga termostaat (vt lk 98, 114, 116, 124)



Duši termostaatsegisti elektroonse start-stop-nupuga. (vt lk 112)

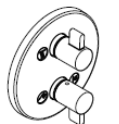

iControl Katkestus- ja ümberlülitusklapp (vt lk 144)



iControl mobile Katkestus- ja ümberlülitusklapp (vt lk 146)

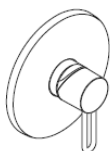

dušisegisti (vt lk 102, 104, 106, 112, 122)



Vanni-duši segisti (vt lk 98, 100, 114, 116)



DVGW

Turvasüsteemiga vanni-duši segisti (vt lk 96)

Turvakombinatsiooni juurest võib defekti korral vett välja tulla!

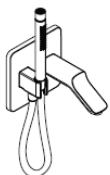

Vtök v kad (vt lk 100)

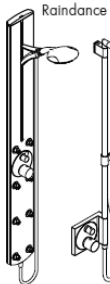



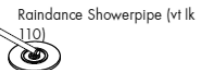



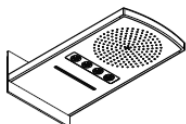





Raindance Duschpaneel (vt lk 106, 108)



Raindance Showerpipe (vt lk 110)



Raindance Rainfall (vt lk 140)

X	Vanni keskoht / Dušivanni kese		peiteklapp
Y	Mõõt Y = vooliku seinaväljavoolu keskmest vannitüüri keskele jagatud 2-ga (võimalusel kohandage keraamiliste plaatide asetusega).	 Quattro	Quattro-liitmik
	Soe vesi	 T r i o	Katkestus- ja ümberlülitusklapp Trio Universal
	Külm vesi		Vanni kraan
	Alates • on funktsioneerimine garanteeritud		Mittevajalik väljavool tuleb sulgeda korgiga. (DN 20 3/4")
	Selles alas tuleb seinu tugevdada.	 > 50 l/min	Äravoolu jõudlus peab olema suurem kui 50 l/min.
	Võimalik on ainult üks funktsioon, mitte kaks korruga.	 Raindrain	Äravool
	Paigaldage kehaduši jaoks vajalikud veetorud kaldega.	 Exafill	iBox ühenduses ära- ja ülevoolugarnituuriga Exafilli vanni sissevooluga (vt lk 95)

Cauruļu montāža

Rotācijā simetriskais iBox korpus ir izmantojams universāli - gan horizontāli, gan vertikāli. Izņemot gadījumus, kad veic vannas armatūras montāžu ar drošības kombināciju - šādos gadījumos iespējama tikai vertikāla iebūve.

Tā kā funkcionālo detaļu bojājuma gadījumā no iBox daļas var izplūst ūdens, iBox jāmontē virs vannas, lai izplūstošais ūdens varētu notecēt vannā!

Ibox ir piemērots gan vannu, gan dušu instalācijām. Vannas jaucējkrāniem ar vienu rokturi apakšējai izplūdei ir prioritāte. Instalējot dušu, nevajadzīgā izplūde jānoblīvē ar aizbāzni.

Korpusu iebūvējiet tā, lai siltā ūdens pieslēgums atrastos pa kreisi un aukstā ūdens pieslēgums - pa labi. Iebūvēšanas dziļums 80 mm līdz 108 mm.

Pagarinājums 25 mm artikula numurs 13595000
Pagarinājums 22 mm (ja iebūvēšanas dziļums nav pietiekams) artikula numurs 13596XXX / 13597XXX / 97407XXX / 98860000

Korpusu iespējams iebūvēt atbilstoši konstrukcijas īpašībām, montāžas piemērus skat. 91. un 92. lpp.

- A** Instalācija pie sienas.
- B** Instalācija pie sienas. Šeit ar elastīgu starpliku un 10 mm izmēra montāžas skrūvēm.
- C** Montāža uz balstu sistēmu.
- D** Instalācija uz gatavām ēku montāžas platēm vai gatavām kabīnēm.
- E** Instalācija tieši sienā.
- F** Instalācija ar montāžas sliekšņu komplektu 96615000.

Uzstādīšanas piemēri ar izmēriem un vadu izkārtojumu atrodami, sākot no 96 lappuses.
Lietoto simbolu izskaidrojums atrodams 72 un 73 lappusē.

Montāžas padoms

Lai iegrieztu savienojuma elementus, iBox ar caurules palīdzību nostipriniet skrūvspilēs.

Skalošana

Izskalojiet visu instalāciju atbilstoši DIN 1988 / EN 1717. Bultiņas uz skalošanas bloka parāda, kurš pievads ir savienots ar attiecīgo izplūdes cauruli, piem., aukstais ūdens ar augšējo izplūdi un siltais ūdens ar apakšējo izplūdi. Ja nepieciešama tikai viena izplūde, pēc pirmās skalošanas reizes par 90° jāpagriež skalošanas bloks.

iBox kombinācijā ar Exafill vannas ielūdi ar noplūdes un pārplūdes garnitūru (skat. 95. lpp.)

Tehniskie dati

Darba spiediens:	maks. 1 MPa
Ieteicamais darba spiediens:	0,1 - 0,5 MPa
Pārbaudes spiediens:	1,6 MPa
(1 MPa = 10 bar = 147 PSI)	
Karstā ūdens temperatūra:	maks. 80 °C
Ieteicamā karstā ūdens temperatūra:	65 °C
Pieslēguma izmēri:	G ¾"
Pieslēgumi:	aukstais pa labi / karstais pa kreisi
Brīva caurplūde, ja ir 0,3 MPa:	
Vannas/ dušas jaucējkrāns Vannas izeja:	31 l/min
Vannas/ dušas jaucējkrāns Dušas izeja:	24 l/min
Dušas jaucējkrāns:	32 l/min
Termostats:	43 l/min
Termostats ar slēgvārstu. / Dušas termostats ar elektro-	
nisku „start/stop” taustiņu:	26 l/min
Termostats ar noslēgvārstu un pārslēdzējvārstu:	26 l/min
Termostats High Flow:	58 l/min
iControl:	30 l/min
iControl mobile:	37 l/min



Termostats (skat. lpp. 118, 120, 126)



High Flow
Termostats High Flow (skat. lpp. 128 - 146)

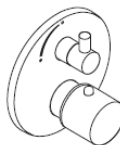

Termostats ar slēgvārstu. (skat. lpp. 102, 104, 106, 112, 122)

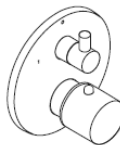

Termostats ar noslēgvārstu un pārslēdzējvārstu. (skat. lpp. 98, 114, 116, 124)



Dušas termostats ar elektronisku „start/stop” taustiņu (skat. lpp. 112)

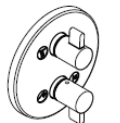

iControl
Noslēgvārsts un pārslēdzējvārsts (skat. lpp. 144)



iControl mobile
Noslēgvārsts un pārslēdzējvārsts (skat. lpp. 146)

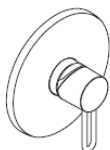

Dušas jaucekļkrāns (skat. lpp. 102, 104, 106, 112, 122)



Vannas/ dušas jaucekļkrāns (skat. lpp. 98, 100, 114, 116)



DVGW
Vannas/ dušas jaucekļkrāns ar integrētu drošības kombināciju (skat. lpp. 96)

No drošības kombinācijas defekta gadījumā var izplūst ūdens!

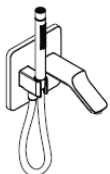

Vannas tekne (skat. lpp. 100)

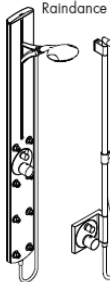





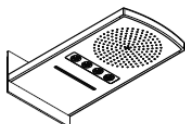









Raindance Duschpaneel (skat. lpp. 106, 108)

Raindance Showerpipe (skat. lpp. 110)



Raindance Rainfall (skat. lpp. 140)

<p>X</p>	<p>Vannas vidus / Dušas paliktņa vidus</p>		<p>Zemapmetuma ventillis</p>
<p>Y</p>	<p>Izmērs Y = šļūtenes savienojuma loka vidu līdz vannas ietece vidum dalīt ar 2 (eventuāli piemērot flīžu rakstam)</p>		<p>Četrvirzienu pārslēgs</p>
	<p>Siltais ūdens</p>		<p>Trīsvirzienu universālais noslēgvārsts un pārslēdzējvārsts</p>
	<p>Aukstais ūdens</p>		<p>Vannas tekne</p>
	<p>No • funkcija nodrošināta</p>		<p>Neizmantoto izteku aizbāzt ar aizbāzni. (DN 20 ¾")</p>
	<p>Šajā zonā ir nepieciešams pastiprināt sienu.</p>		<p>Notece veikspējai jābūt vairāk nekā 50 l/min.</p>
	<p>Iespējams tikai viens patērētājs, nedrīkst vienlaikus būt divi patērētāji.</p>		<p>Notece</p>
	<p>Montēt ūdens cauruļvadus sānu (ķermeņa) dušām ar atbilstošu slīpumu.</p>		<p>iBox kombinācijā ar Exafill vannas iepļūdi ar noplūdes un pārplūdes garnitūru (skat. 95. lpp.)</p>

Priprema montaža

Rotaciono simetrično telo jedinice iBox je univerzalno primenljivo, kako horizontalno tako i vertikalno. Izuzetak predstavlja montaža armatura za kade sa sigurnosnom kombinacijom, jer je tu moguća samo vertikalna ugradnja.

Pošto kod kvara pojedinih delova iz iBox-a može isticati voda, iBox se mora instalirati iznad kade, tako da voda može oticati u kadu!

iBox je pogodan za ugradnju na tuš i instalaciju za kade. Kod jednoručnih mešača za kadu prioritetan je donji izlaz. Kod instalacije na tuš izlaz koji se ne upotrebljava mora da se zatvori čepom.

Montirajte telo tako da priključak tople vode bude sa leve, a hladne sa desne strane.

Dubina ugradnje 80 - 108 mm.

Produžetak 25 mm br. Proizvoda 13595000

Produžetak 22 mm (kod manje dubine ugradnje) br.

Proizvoda 13596XXX / 13597XXX / 97407XXX / 98860000

Telo može da se montira u skladu sa uslovima na mestu ugradnje, za primere montaže vidi strane 91 i 92.

- A** Direktna instalacija na zid.
- B** Direktna instalacija na zid sa držačem odstojanja pomoću 10 mm podesivih zavrtnja.
- C** Montaža na sistem nosača.
- D** Instalacija na gotove montažne ploče ili gotove ćelije.
- E** Instalacija direktno u zid.
- F** Instalacija sa setom instalacionih šina 96615000.

Primeri instalacija sa veličinama i dimenzijama vodova mogu se naći od stranice 96 nadalje.

Objašnjenje korišćenih simbola nalazi se na stranici 75 i 76.

Savet u vezi montaže

Za uvrtnje priključnih elemenata iBox treba zategnuti u stegu uz pomoć komada cevi.

Ispiranje

Kompletnu instalaciju treba isprati u skladu sa normom DIN 1988 / EN 1717. Strelice na bloku prikazuju koji je dovod spojen sa kojim odvodom, npr. hladna voda sa donjim, a topla sa gornjim odvodom. Ukoliko je potreban samo jedan odvod, onda se nakon prvog ispiranja blok mora zakrenuti za 90°.

iBox u kombinaciji sa Exafill dotokom kade sa odvodnom i prelivnom garniturom (vidi stranu 95)

Tehnički podaci

Radni pritisak:	maks. 1 MPa
Preporučeni radni pritisak:	0,1 - 0,5 MPa
Probni pritisak:	1,6 MPa
(1 MPa = 10 bar = 147 PSI)	
Temperatura vruće vode:	maks. 80 °C
Preporučena temperatura vruće vode:	65 °C
Rastojanje između centara priključaka:	G ¾"
Priključci:	hladna voda desno - topla levo
Slobodan protok na 0,3 MPa:	
Mešač za kadu Ogranak kada:	31 l/min
Mešač za kadu Ogranak tuš:	24 l/min
Mešač tuša:	32 l/min
Termostat:	43 l/min
Termostat s ventilom za zatvaranje / Termostat tuša s elektronskim start-stop prekidačem:	26 l/min
Termostat s ventilom za zatvaranje i preklopnim ventilom:	26 l/min
Termostat High Flow:	58 l/min
iControl:	30 l/min
iControl mobile:	37 l/min



Termostat (vidi stranu 118, 120, 126)



High Flow

Termostat High Flow (vidi stranu 128 - 146)



Termostat s ventilom za zatvaranje (vidi stranu 102, 104, 106, 112, 122)

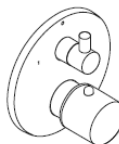

Termostat s ventilom za zatvaranje i preklopnim ventilom (vidi stranu 98, 114, 116, 124)



Termostat tuša s elektronskim start-stop prekidačem (vidi stranu 112)

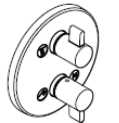

iControl Ventil za zatvaranje i preklopni ventil (vidi stranu 144)



iControl mobile Ventil za zatvaranje i preklopni ventil (vidi stranu 146)



Mešač tuša (vidi stranu 102, 104, 106, 112, 122)



Mešač za kadu (vidi stranu 98, 100, 114, 116)



DVGW

Mešač za kadu s ugrađenim sigurnosnim sistemom (vidi stranu 96)

Kod sigurnosne kombinacije u slučaju kvara može doći do isticanja vode!

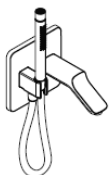

Dotok kade (vidi stranu 100)

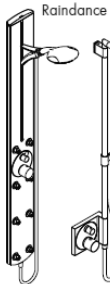





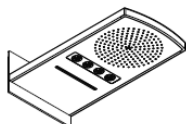









Raindance Duschpaneel (vidi stranu 106, 108)

Raindance Showerpipe (vidi stranu 110)



Raindance Rainfall (vidi stranu 140)

<p>X</p>	<p>Sredina kade / Sredina tuš-kada</p>		<p>Uzidni ventil</p>
<p>Y</p>	<p>Mera Y = sredina priključnog luka creva do sredine dotoka kade podeljeno sa 2 (eventualno prilagoditi rasteru pločica).</p>		<p>Quattro četverostruki preusmerivač</p>
	<p>topla voda</p>		<p>Trio Universal ventil za zatvaranje i preklonni ventil</p>
	<p>hladna voda</p>		<p>Dotok kade</p>
	<p>Od • je funkcija zagarantovana.</p>		<p>Izlaz koji se ne koristi, mora se zatvoriti slepim čepom. (DN 20 ¾")</p>
	<p>U ovoj oblasti je potrebno ojačanje zida.</p>		<p>Kapacitet odvoda mora biti veći od 50 l/min.</p>
	<p>Moguće je koristiti samo jedan potrošač, nikako dva istovremeno!</p>		<p>Ispust</p>
	<p>Položite vodovodne cevi za bočni tuš s nagibom.</p>		<p>iBox u kombinaciji sa Exafill dotokom kade sa odvodnom i prelivnom garniturom (vidi stranu 95)</p>

Råmontasje

Det rotasjonsymetriske basiselementet til iBox kan brukes universelt dvs. horisontalt og vertikalt. Et unntak er ved montasje av kararmatur med sikkerhetskombinasjon. Da er det kun mulig med vertikal montasje.

Etttersom det kan lekke vann ut av iBoxen ved en defekt, skal iBoxen monteres over badekaret, slik at vannet som lekker ut kan renne ned i badekaret.

iBoxen egner seg både for installasjon på dusj eller badekar. Ved enhånd-blandebatteri for badekar prioriteres nedre utgangen. Ved installasjon i dusjen skal utgangen som ikke brukes tettes med en plugg.

Basiselementet bygges inn slik at varmtvannstilkobling er på venstre og kaldtvannstilkobling er på høyre side. Innbyggingsdybde 80 mm til 108 mm. Forlengelse 25 mm Artikkelnummer 13595000 Forlengelse 22 mm (ved liten montasje dybde) Artikkelnnummer 13596XXX / 13597XXX / 97407XXX / 98860000

Basiselementet kan monteres iht. byggmessige forhold, se montasje-eksempel på side 91 og 92.

- A** Installasjon på vegg
- B** Installasjon på vegg. Her med fleksible avstandsholdere via spesialskruer.
- C** Montasje på bæresystem.
- D** Installasjon på ferdighus-montasjeplater eller ferdigceller.
- E** Installasjon rett på vegg.
- F** Installasjon med sett av montasjeskinner 96615000.

Installasjonseksempel med målangivelser og ledningsdimensjoner finns fom. side 96.

Forklaring for brukte symboler på side 78 og 79.

Montasje-tipp

For å skru inn koblinger skal iBoxen settes fast i en skrutikke ved hjelp av et rør.

Spyle

Komplett installasjon spyles iht. DIN 1988 / EN 1717. Pilene på spyleblokken indikerer hvilke tilløp som er koblet sammen med hvilken utgangsledning, f.eks. kaldtvann med nedre utgangen og varmtvann med øvre utgangen. Hvis det kun er nødvendig med en utgang, skal spyleblokken dreies med 90° etter den første spylingen.

iBox i kombinasjon med Exfill karinnløp med avløps- og overflytgarnityr (se side 95)

Tekniske data

Driftstrykk	maks. 1 MPa
Anbefalt driftstrykk:	0,1 - 0,5 MPa
Prøvetrykk	1,6 MPa
(1 MPa = 10 bar = 147 PSI)	
Varmtvannstemperatur	maks. 80 °C
Anbefalt temperatur for varmt vann	65 °C
Tilkoblingsmål:	G ¾"
Tilkoblinger:	kaldt høyre - varm venstre
Fri gjennomstrømning ved 0,3 MPa:	
Blandebatteri for badekar Utgang kar:	31 l/min
Blandebatteri for badekar Utgang dusj:	24 l/min
Dusj-blandebatteri:	32 l/min
Termostat:	43 l/min
Termostat med sperreventil / Dusjtermostat med elektronisk start- / stopptast:	26 l/min
Termostat med sperre- og omstillingsventil:	26 l/min
Termostat High Flow:	58 l/min
iControl:	30 l/min
iControl mobile:	37 l/min



Termostat (se side 118, 120, 126)



High Flow

Termostat High Flow (se side 128 - 146)



Termostat med sperreventil (se side 102, 104, 106, 112, 122)

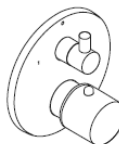

Termostat med sperre- og omstillingsventil (se side 98, 114, 116, 124)



Dusjtermostat med elektronisk start- / stopptast (se side 112)

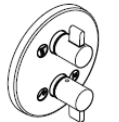

iControl Stenge- og omstillingsventil (se side 144)



iControl mobile Stenge- og omstillingsventil (se side 146)

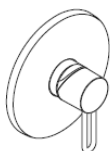

Dusj-blande batteri (se side 102, 104, 106, 112, 122)



Blande batteri for badekar (se side 98, 100, 114, 116)



DVGW

Blande batteri for badekar med integrert sikkerhetskombinasjon (se side 96)

Ved defekt kan det lekke vann ut av sikkerhetskombinasjonen!

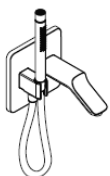

Innløp badekar (se side 100)

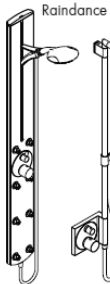





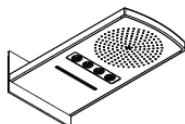









Raindance Dusjpaneel (se side 106, 108)

Raindance Showerpipe (se side 110)



Raindance Rainfall (se side 140)

- X** Midten av badekaret / Midten på dusjkar  Innfelt ventil
- Y** Mål Y = Midten til slangetilkoblingsbue t.o.m. badekarinnløp delt på 2 (eventuelt skal fliseraster tilpasses).  Quattro fire-veis omstilling
-  Varmtvann  Trio universal stenge- og omstillingsventil
-  Kaldtvann  Innløp badekar
-  F.o.m. • er funksjonen garantert  Utgangen som ikke brukes kan tettes med en blindplugg. (DN 20 ¾")
-  I dette området skal vegg forsterkes.  Avløp ytelse skal være mer enn 50 l/min.
-  Kun en forbruker mulig, ikke to samtidig.  Avløp
-  Vannledninger for sidedusjer installeres med fall.  iBox i kombinasjon med Exfill karinnløp med avløps- og overflytgarnityr (se side 95)

Първичен монтаж

Ротационно-симетричното основно тяло на iBox може да се приложи универсално, хоризонтално и вертикално. Изключение прави монтажът на арматурата за вана с комплект предпазители, тук е възможен само вертикален монтаж.

Тъй като при дефект на функционалните части около iBox може да изтече вода, iBox трябва да се монтира над ваната, за да може изтичащата вода да се отича във ваната!

iBox е подходяща както за инсталации на вани, така и за душове. При смесители за вана с една ръкохватка първостепенен е долният извод. При инсталация на разпръсквател излишният извод трябва да се уплътни с глуха пробка.

Основното тяло се монтира така, че изводът за топла вода да се намира отляво, а за студена вода отдясно. Монтажна дълбочина 80 мм до 108 мм. Удължител 25 мм Номенклатурен номер 13595000 Удължител 22 мм (при малка монтажна дълбочина) Номенклатурен номер 13596XXX / 13597XXX / 97407XXX / 98860000

Основното тяло може да се закрепни на стената в съответствие с конструктивните дадености, примери за монтаж на стр. 91 и 92.

- A** Инсталация на стената.
- B** Инсталация на стената. Тук с гъвкава разпънка с помощта на комбинирани болтове 10.
- C** Монтаж на трегерната система.
- D** Инсталация на монтажни плочи на сглобяеми сгради или готови клетки.
- E** Инсталация директно в стената.
- F** Инсталация с набор монтажни шини 96615000.

Примери за инсталация с данни за размери и определяне на размерите на тръбопроводите можете да намерите от стр. 96 нататък.

Разяснения на използваните символи на стр. 81 и 82.

Съвети при монтаж

За да завинтите присъединителните елементи затегнете iBox с помощта на тръбен елемент в менюте.

Промиване

Промийте цялата инсталация съгласно DIN 1988 / EN 1717. Стрелките на промивачия блок показват, кой вход с кой изходящ тръбопровод е свързан, напр. студена вода с долния извод, а топла вода с горния извод. В случай, че е необходим само един изход, след първия процес на промиване промивачият блок трябва да се завърти на 90°.

iBox в комбинация с вход за вана Exafill с гарнитура за изтичане и преливане. (вижте стр. 95)

Технически данни

Работно налягане:	макс. 1 МПа
Препоръчително работно налягане:	0,1 - 0,5 МПа
Контролно налягане:	1,6 МПа
(1 МПа = 10 bar = 147 PSI)	
Температура на горещата вода:	макс. 80 °C
Препоръчителна температура на горещата вода:	65 °C
Присъединителни размери:	G ¾"
Изводи:	студено отдясно – топло отляво
Свободен поток при 0,3 МПа:	
Смесител за вана Извод вана:	31 л/мин
Смесител за вана Изход разпръсквател:	24 л/мин
Смесител на разпръсквателя:	32 л/мин
Термостат:	43 л/мин
Термостат със спирателен клапан / Термостат на разпръсквателя с електронен бутон за пускане и спиране:	26 л/мин
Термостат със спирателен и превключващ клапан:	26 л/мин
Термостат High Flow:	58 л/мин
iControl:	30 л/мин
iControl mobile:	37 л/мин



Термостат (вижте стр. 118, 120, 126)



High Flow
Термостат High Flow (вижте стр. 128 - 146)



Термостат със спирателен клапан (вижте стр. 102, 104, 106, 112, 122)

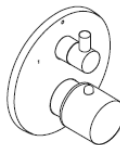

Термостат със спирателен и превключващ клапан (вижте стр. 98, 114, 116, 124)

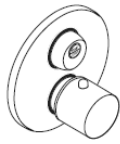

Термостат на разпръсквателя с електронен бутон за пускане и спиране (вижте стр. 112)

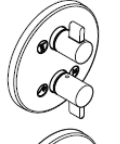

iControl
Спирателен и превключващ клапан (вижте стр. 144)



iControl mobile
Спирателен и превключващ клапан (вижте стр. 146)



Смесител на разпръсквателя (вижте стр. 102, 104, 106, 112, 122)



Смесител за вана (вижте стр. 98, 100, 114, 116)



DVGW
Смесител на вана с интегриран комплект предпазители (вижте стр. 96)

При дефект от комплекта предпазители може да изтече вода!

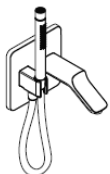

Вход за вана (вижте стр. 100)

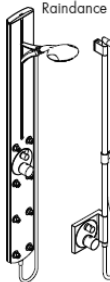

Raindance Duschpaneel (вижте стр. 106, 108)

Raindance Showerpipe (вижте стр. 110)

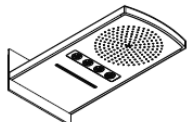

Raindance Rainfall (вижте стр. 140)

	<p>Среда на ваната / Среда на коритото на душ-кабината</p>		<p>Клапан за мазилка</p>
	<p>Мярка Y = Среда на присъединителното коляно на маркуча до входа на ваната разделено на 2 (евентуално изравнете към растера на плочките).</p>	 Quattro	<p>Четирипътно превключване Quattro</p>
	<p>Топла вода</p>	 Trio	<p>Спирателен и превключващ клапан Trio Universal</p>
	<p>Студена вода</p>		<p>Вход за вана</p>
	<p>От • функцията е гарантирана.</p>		<p>Излишният извод може да се уплътни с глуха пробка. (DN 20 ¾")</p>
	<p>В тази област е необходимо подсилване на стената.</p>		<p>Мощността на изтичане трябва да бъде повече от 50 л/мин.</p>
	<p>Възможен е само един консуматор, не два едновременно.</p>	 Raindrain	<p>Отвеждане</p>
	<p>Водопроводните линии за страничните разпръскватели полагайте с наклон.</p>	 Exafill	<p>iBox в комбинация с вход за вана Exafill с гарнитура за изтичане и преливане. (вижте стр. 95)</p>

Montimi në vija të trasha

Trupi bazë me rotacion simetrik i iBox-it mund të përdoret në mënyrë universale, si horizontalisht, ashtu edhe vertikalisht. Me përjashtim të montimit të armaturës së vaskës me kombinim me elemente sigurie. Kështu është i mundur vetëm montimi vertikal.

Meqë në rast të ndonjë defekti të pjesëve funksionale mund të rrjedhë ujë nga iBox-i, është e nevojshme që iBox-i të montohet sipër vaskës, me qëllim që uji që rrjedh të derdhet në vaskë!

iBox-i është i përshtatshëm si për instalimin me vaskën, ashtu edhe me dushin. Te rubinetet me një dorezë për përzierjen e ujit për vaskën ka prioritet dalja e poshtme. Në rast se instalohet dushi, atëherë dalja që nuk nevojitet duhet mbyllur me një tapë.

Trupi bazë duhet montuar në atë mënyrë që lidhja e ujit të ngrohtë të jetë në të majtë dhe ajo e ujit të ftohtë në të djathtë.

Thellësia e montimit 80 mm deri 108 mm.

Zgjatësi 25 mm Numri i artikullit 13595000

Zgjatësi 22 mm (lartësia e montimit jo e madhe) Numri i artikullit 13596XXX / 13597XXX / 97407XXX / 98860000

Trupi bazë mund të montohet duke iu përshtatur kushteve ndërtimore. Shembuj të montimit gjinden në faqet 91 dhe 92.

- A** Instalimi në mur.
- B** Instalimi në mur. Këtu me distancues të lakueshëm përmes vidhave lidhëse 10-she.
- C** Montimi në sistemin mbajtës.
- D** Instalimi në pllaka montimi parafabrikate.
- E** Instalimi direkt në mur.
- F** Instalimi me kompletin e shinave të montazhit 96615000.

Shembujt e instalimit me përmasat dhe dimensionimet e tubacioneve mund t'i gjeni nga faqja 96.

Shpjegimi i simboleve të përdorura gjendet në faqen 84 dhe 85.

Këshilla rreth montimit

Për të rrotulluar lidhjet duhet lidhur iBox/ me anë të një pjesë të tubit në morskë.

Shpëlarje

Të gjitha instalimet duhen shpëlarë sipas normës DIN 1988 / EN 1717. Shigjetat në njësinë shpëlarëse tregojnë se me cilën dalje është lidhur secila hyrje, p.sh. uji i ftohtë me daljen e poshtme dhe uji i ngrohtë me daljen e sipërme. Nëse do të nevojitet vetëm një dalje, atëherë pas procesit të shpëlarjes së parë njësjia shpëlarëse duhet rrotulluar 90°.

iBox-i në kombinim me në garniturë dalëse dhe rrjedhëse Exafill hyrjen e vaskës (shih faqen 95)

Të dhëna teknike

Presioni gjatë punës	maks. 1 MPa
Presioni i rekomanduar:	0,1 - 0,5 MPa
Presioni për provë:	1,6 MPa
(1 MPa = 10 bar = 147 PSI)	
Temperatura e ujit të ngrohtë	maks. 80 °C
Temperatura e rekomanduar e ujit të ngrohtë:	65 °C
Përmasat e lidhjeve:	G ¾"
Lidhjet:	i ftohtë djathtas - i ngrohtë majtas
Rrjedhja e lirë me 0,3 Mpa:	
Rubineti i vaskës Dalja e vaskës:	31 l/min
Rubineti i vaskës Dalja e spërkatësës:	24 l/min
Spërkatësja me ujë të përzier:	32 l/min
Termostati:	43 l/min
Termostati me ventil bllokues / Termostati i spërkatësës me buton elektronik start-stop:	26 l/min
Termostati me ventil bllokues dhe ventil për ndërrimin e pozicionit:	26 l/min
Termostati High Flow:	58 l/min
iControl:	30 l/min
iControl mobile:	37 l/min



Termostati (shih faqen 118, 120, 126)



High Flow

Termostati High Flow (shih faqen 128 - 146)



Termostat me ventil bllokues (shih faqen 102, 104, 106, 112, 122)

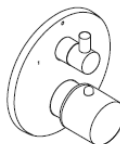

Termostati me ventil bllokues dhe ventil për ndërrimin e pozicionit (shih faqen 98, 114, 116, 124)



Termostati i spërkatësës me buton elektronik start-stop (shih faqen 112)

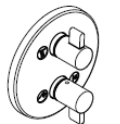

iControl Valvula e bllokimit dhe e devijimit (shih faqen 144)



iControl mobile Valvula e bllokimit dhe e devijimit (shih faqen 146)



Spërkatësja me ujë të përzier (shih faqen 102, 104, 106, 112, 122)



Rubineti i vaskës (shih faqen 98, 100, 114, 116)



DVGW

Rubineti i vaskës me kombinim të integruar të sigurisë (shih faqen 96)

Në kombinimin me elemente sigurie mund të rrjedhë ujë në rast defektil

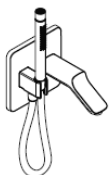

Vrima për mbushjen e vaskës (shih faqen 100)

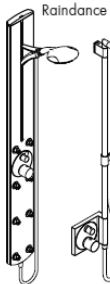





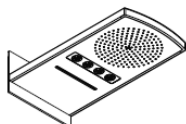









Raindance Duschpaneel (shih faqen 106, 108)

Raindance Showerpipe (shih faqen 110)



Raindance Rainfall (shih faqen 140)

X	Mesi i vaskës / Mesi i vaskës së dushit		Ventili i suvajës
Y	Përmasa Y = mesi i harkut të lidhjes së zor-rës deri tek mesi i hyrjes së vaskës pjesëtim për 2 (eventualisht i duhet përshtatur këndit të pllakave të murit).	 Quattro	Valvul devijuese Quattro me katër drejtime
	Uji i ngrohtë	 T r i o	Valvul universale Trio për bllokim dhe devijim
	Uji i ftohtë		Vrima për mbushjen e vaskës
	Nga • është i mundur funksioni.		Dalja që nuk nevojitet duhet izoluar me tapë qorre. (DN 20 3/4")
	Në këtë zonë është i nevojshëm një përfërim i murit.	 > 50 l/min	Kapaciteti i shkarkimit duhet të jetë më shumë se 50 l/minutë.
	Ekziston mundësia vetëm për një konsumator, jo për dy njëkohësisht.	 Raindrain	Shkarkimi
	Vendosni tubacionet e ujit për spërkatëset anësore me pjerrësi.	 Exafill	iBox-i në kombinim me në garniturë dalëse dhe rrjedhëse Exafill hyrjen e vaskës (shih faqen 95)

صمام التدفق		منتصف حوض الاستحمام / بانيو مزود بدش في المنتصف	X
تغيير مسار رباعي كواترو		البعد $Y =$ مركز مرفق مخرج حائط الخرطوم إلى مركز حشوة الحمام مقسوماً علي 2 (مطابق لشكل البلطة إن أمكن).	Y
صمام حجز وتغيير تريبو يونيفرسال		ماء دافئ	
مدخل مياه للبانوي		ماء بارد	
قم بسد المنفذ غير المستخدم. (DN 20 ¼")		من • الوظيفة مضمونة.	
يجب أن تكون قدرة الصرف أكبر من 50 لتر/دقيقة		يلزم هذا في النطاق وجود تقوية للحائط.	
تصريف		لا يمكن القيام بأكثر من وظيفة واحدة.	
وحدة "iBox" مع وحدة التدفق بالحوض من النوع "Exafill" مع لوازم تصريف الماء وتصريف تدفق المياه. (راجع صفحة 115)		قم بتركيب مواسير المياه للشدن العادي المنحدر.	

خلاط الدش (راجع صفحة 102،
104، 106، 112، 122)

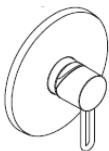

ترموستات (راجع صفحة 118،
120، 126)



خلاط دش الحمام (راجع
صفحة 98، 100، 114، 116)

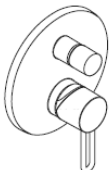

ترموستات High Flow (راجع
صفحة 128 - 146)



خلاط دش الحمام بمجموعة أمان
مدمجة (راجع صفحة 96)



ترموستات متصل بصمام غلق
(راجع صفحة 102، 104، 106،
112، 122)



ترموستات متصل بصمامات غلق
وتحويل (راجع صفحة 98، 114،
116، 124)



وفي حالة حدوث أي عطل، يمكن أن
تخرج المياه من خلال تركيبة الأمان.
مدخل مياه للبانو (راجع صفحة
100)

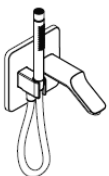

خلاط الدش المزود بترموستات وزر
بدء تشغيل - إيقاف إلكتروني (راجع
صفحة 112)



Raindance Duschpaneel
(راجع صفحة 106، 108)

Raindance Showerpipe
(راجع صفحة 110)



iControl
صمام الحجز والتغيير (راجع صفحة
144)

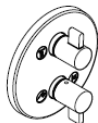

Raindance
Rainfall
(راجع صفحة 114)



iControl mobile
صمام الحجز والتغيير (راجع صفحة
146)



تركيب الأبواب

يتم استخدام الجسم الرئيسي ذبوالدوران المتمائل للوحدة "iBox" في جميع أنحاء العالم سواء بصورة أفقية أو رأسية. إلا أنه لا يمكن القيام بالتركيب إلا بصورة رأسية في هذه الحالة إلا في حالة تركيب لوازم الحوض باستخدام تركيبية الأمان.

احرص دوماً على تركيب iBox فوق حوض الاستحمام (البانيو). إذا تعرضت أجزاء من iBox للكسر، فربما يتسبب ذلك في تسرب المياه في كل مكان!

تد وحدة "iBox" ملائمة لتركيب حوض الاستحمام أو الدش. وفي حالة استخدام خلاط بالحوض بصنوبر واحد فقط، يفضل استخدام الصرف السفلي. وعند القيام بتركيب الدش، يجب سد المنفذ غير المستخدم عن طريق سداة.

قم بتركيب الجسم الرئيسي للوحدة بصورة ملائمة بحيث توجد وصلة المياه الساخنة في الجانب الأيسر ووصلة المياه الباردة في الجانب الأيمن.

عمق التركيب: من 1_eم حتى 1_fم.

وصلة إطالة 25 مم رقم الصنف 13595000

طقم الملحقات 22 مم (عندما لا يكون الجدار عميقاً بما يكفي). رقم الصنف 13597XXX / 13596XXX / 97407XXX / 98860000

يمكن تركيب الجسم الرئيسي للوحدة وفقاً لظروف البناء، انظر أمثلة التركيب صفحتي 80 و 108.

A التركيب على حائط مباشر

B التركيب على الحائط المباشر بجوابط تركيب قابلة للضغط طولها 10 مم.

C التركيب على نظام حمامات.

D التركيب على لوحات التركيب للمنازل الجاهزة البناء أو على الخاليا الجاهزة.

E التركيب على حائط من الطوب

F التركيب باستخدام طقم التثبيت 9661500.

يوجد بدءاً من صفحة 96 أمثلة للتركيب بمقاسات وطرق عمل بعض الوصلات.

يوجد شرح للرموز المستخدمة على الصفحات 85 و 86.

نصائح خاصة بعملية التركيب

من أجل لف الوصلات، يجب تركيب وحدة "iBox" في الملمزة باستخدام أنبوبة.

نظام سريان الماء عبر المواسير

يجب غسل الوحدة المركبة بالكامل وفقاً للمعيار DIN 1988/EN 1717 لتحديد الأسهم الموجودة على وحدة الغسل أي وصلة تغذية بالمياه ترتبط بأية وصلة صرف، على سبيل المثال: المياه الباردة مع وصلة الصرف السفلي، والمياه الساخنة مع وصلة الصرف العليا. إذا كان هناك حاجة إلى وصلة صرف واحدة فقط، يجب لف وحدة الغسل قبل أول استخدام لها بنسبة 90° درجة.

وحدة "iBox" مع وحدة التدفق بالحوض من النوع "Exafill" مع لوازم تصريف الماء وتصريف تدفق المياه. (راجع صفحة 95)

المواصفات الفنية

ضغط التشغيل: الحد الأقصى 1 ميجاباسكال

ضغط التشغيل الموصى به: 0,5 - 0,1 ميجاباسكال

ضغط الاختيار: 1,6 ميجاباسكال

(1 ميجاباسكال = 10 بار = 147 PSI)

درجة حرارة الماء الساخن: الحد الأقصى 80°C

درجة الحرارة الموصى بها للماء الساخن: 65°C

المسافة المركزية: 3/4" G

النوصيلات: الماء البارد جهة اليمين - الماء الساخن جهة اليسار

معدل تدفق 0,3 ميجاباسكال:

31 لتر / الدقيقة / خلط دق الحمام صرف البانيو:

24 لتر / الدقيقة / خلط دق الحمام صرف الرشاش:

32 لتر / الدقيقة / خلط الدش:

43 لتر / الدقيقة / ترموستات:

ترموستات متصل بصمام غلق / خلط الدش المزود

بترموستات وزر بدء تشغيل -

26 لتر / الدقيقة / إيقاف إلكتروني:

26 لتر / الدقيقة / ترموستات متصل بصمامات غلق وتحويل:

58 لتر / الدقيقة / ترموستات High Flow:

30 لتر / الدقيقة / iControl:

37 لتر / الدقيقة / iControl mobile:

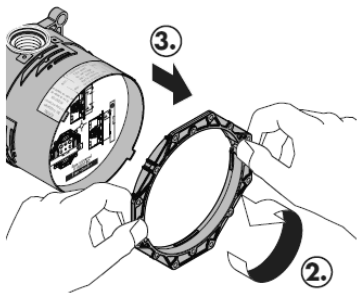
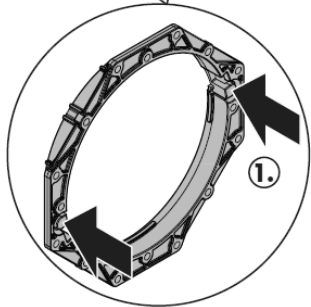
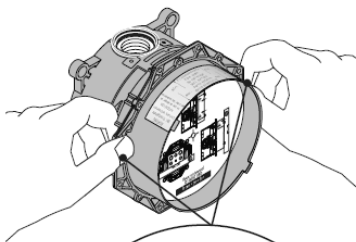
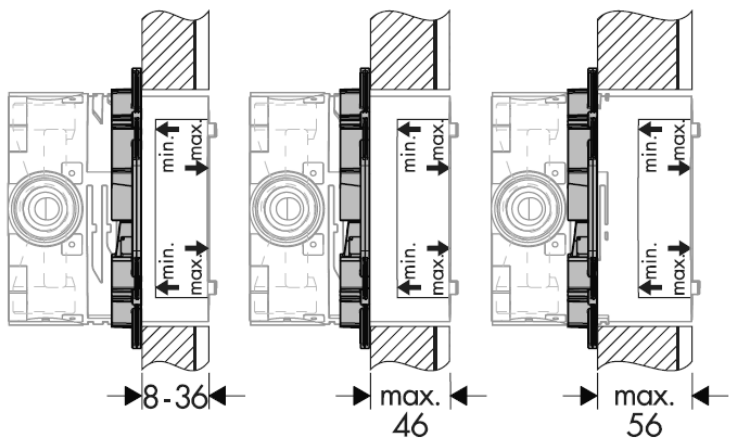

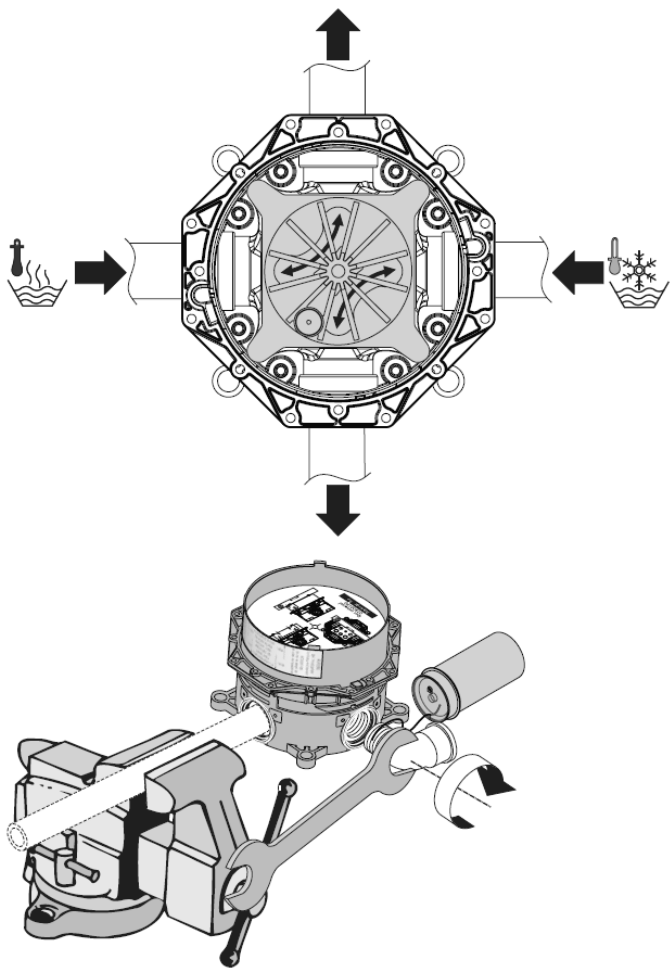

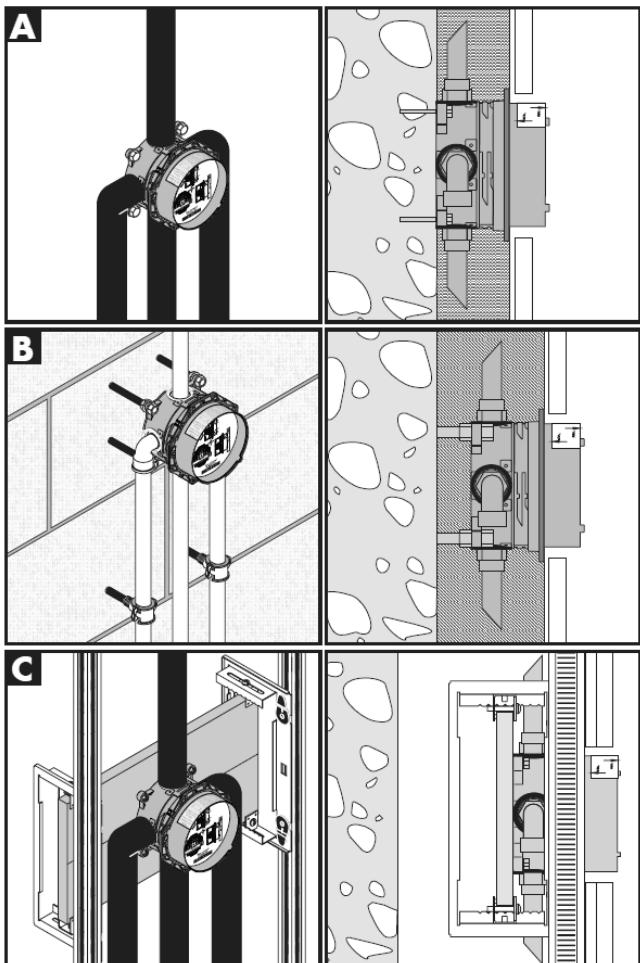

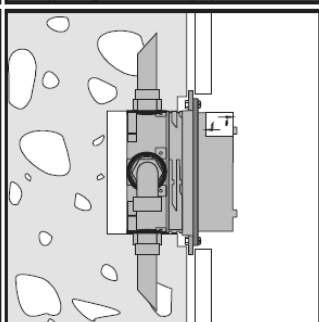
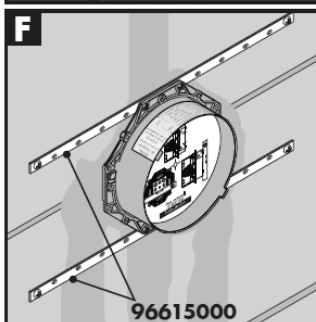
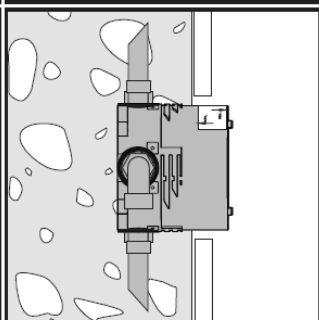
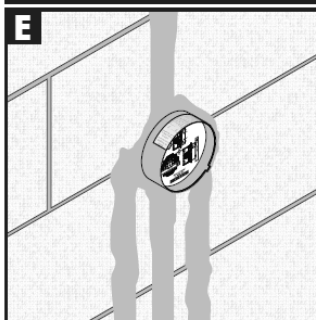
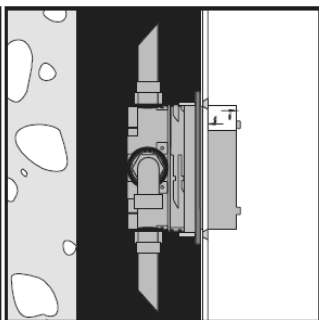
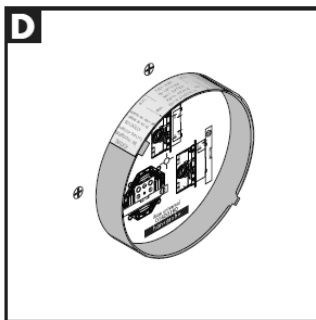

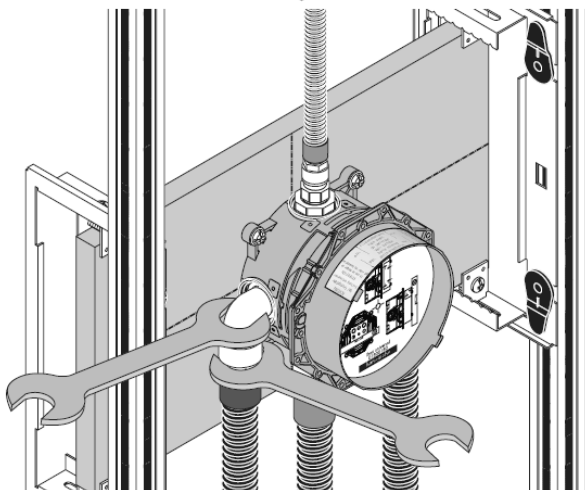
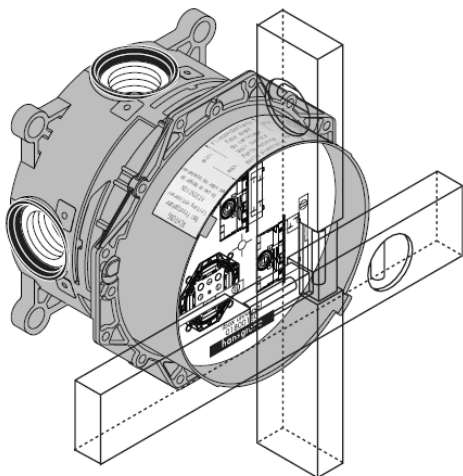

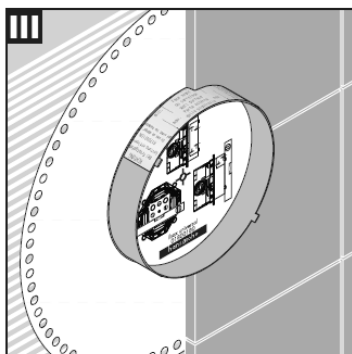
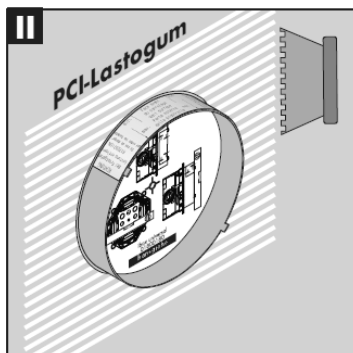
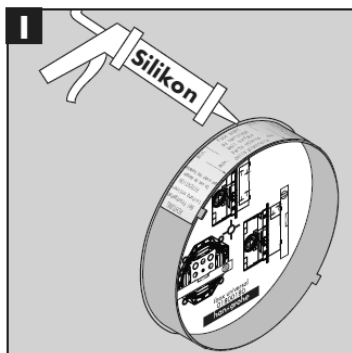

iBox universal + Excafill

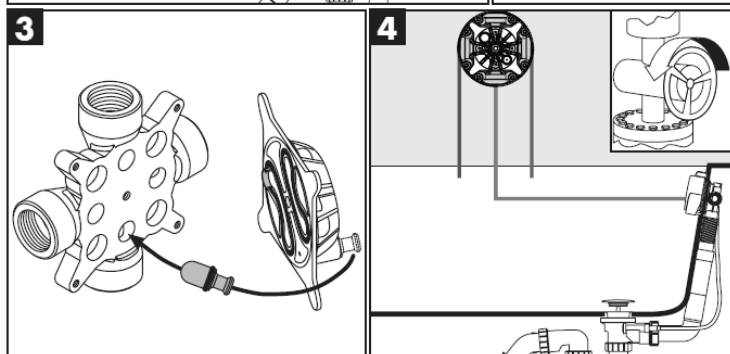
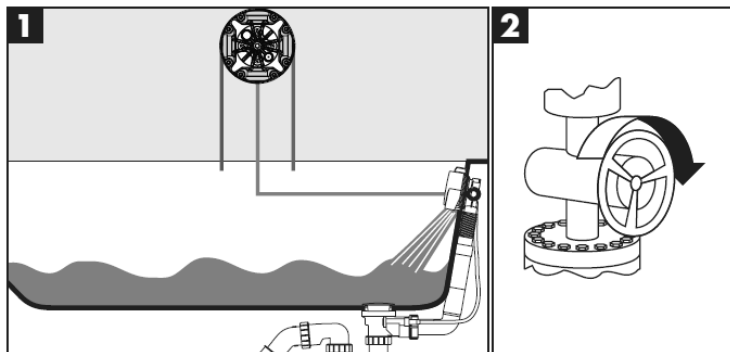
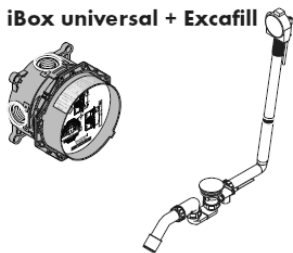

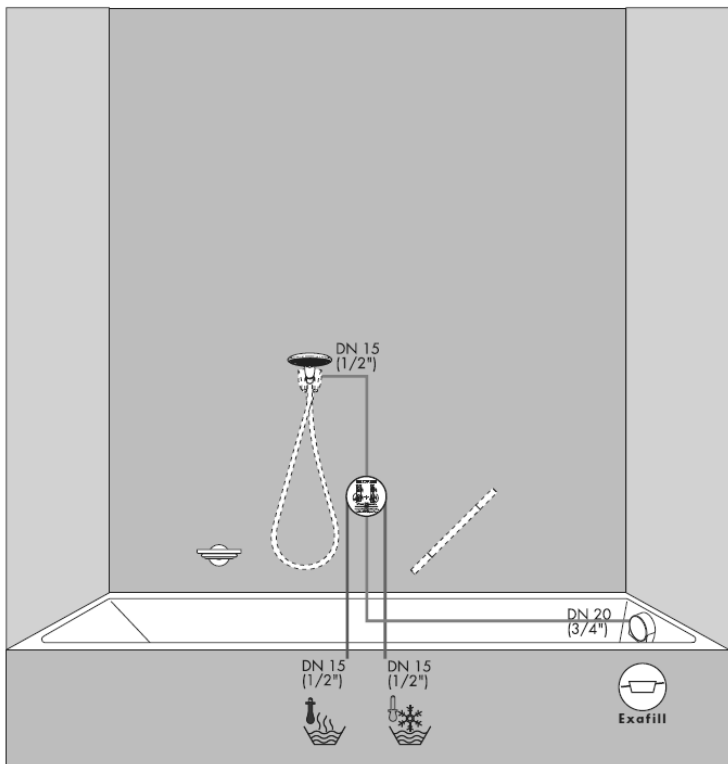

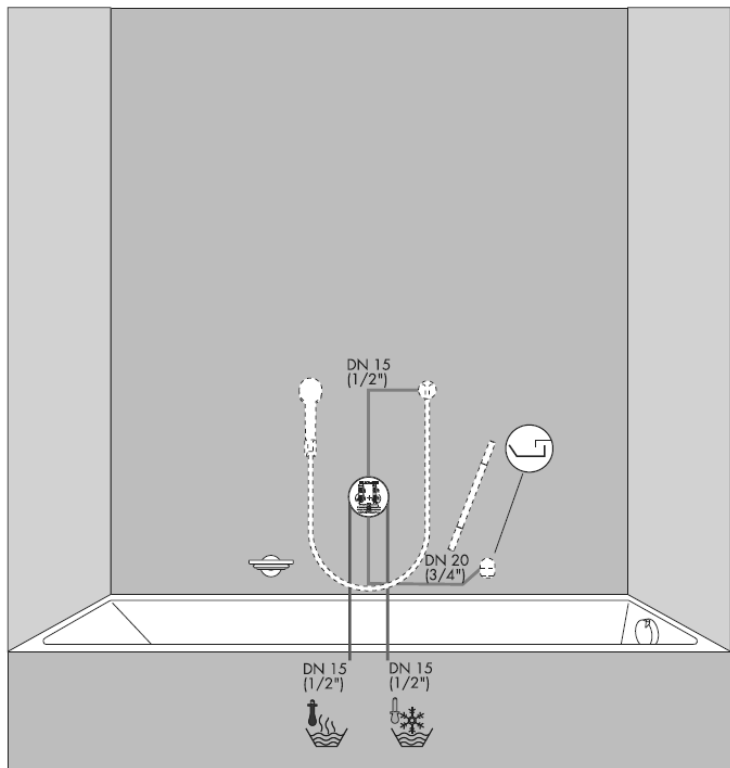

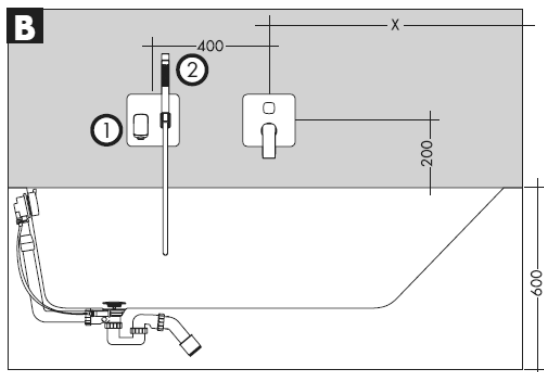
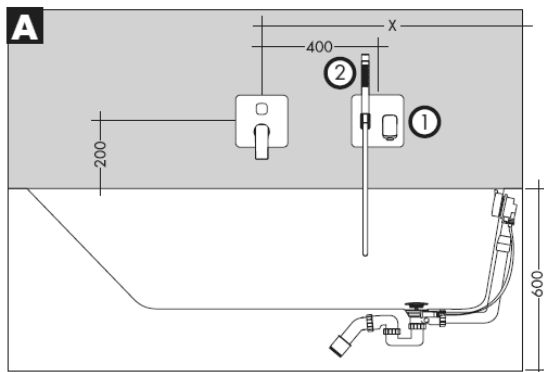
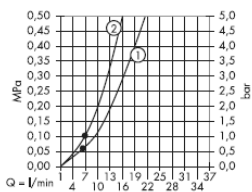
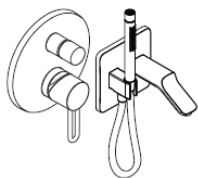

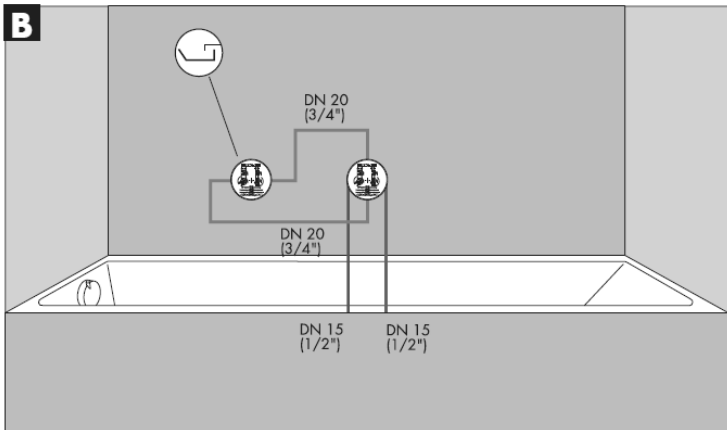
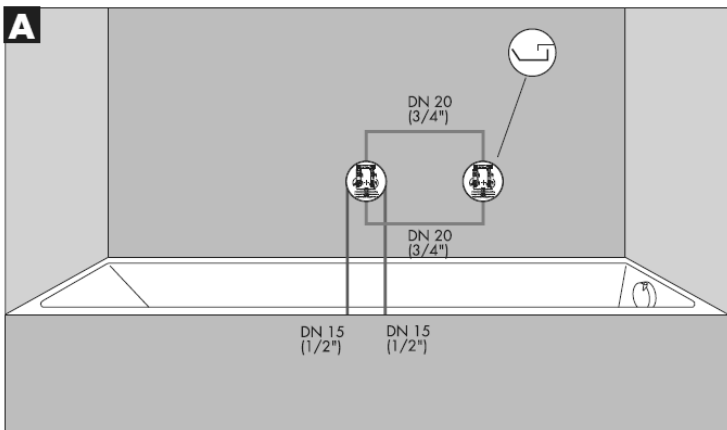

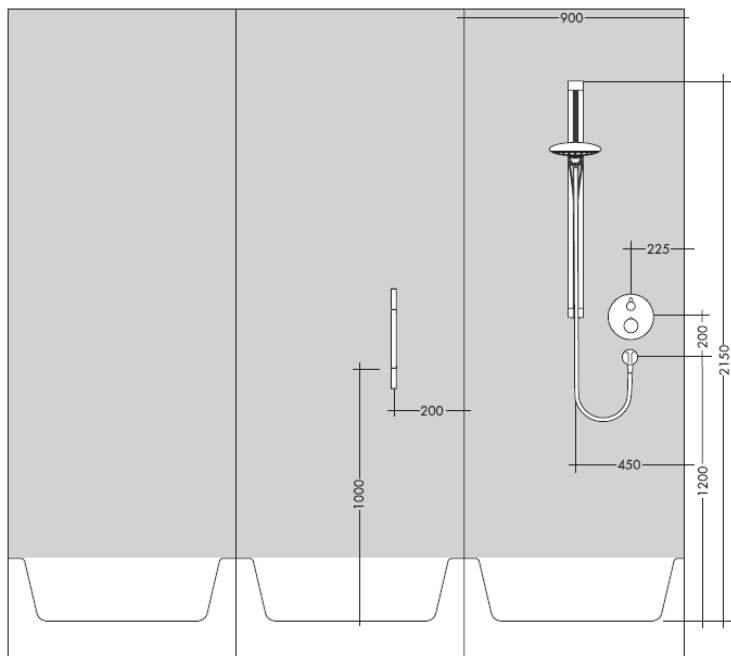
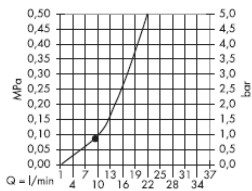
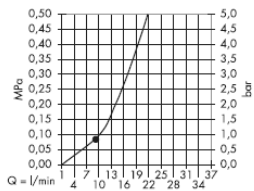

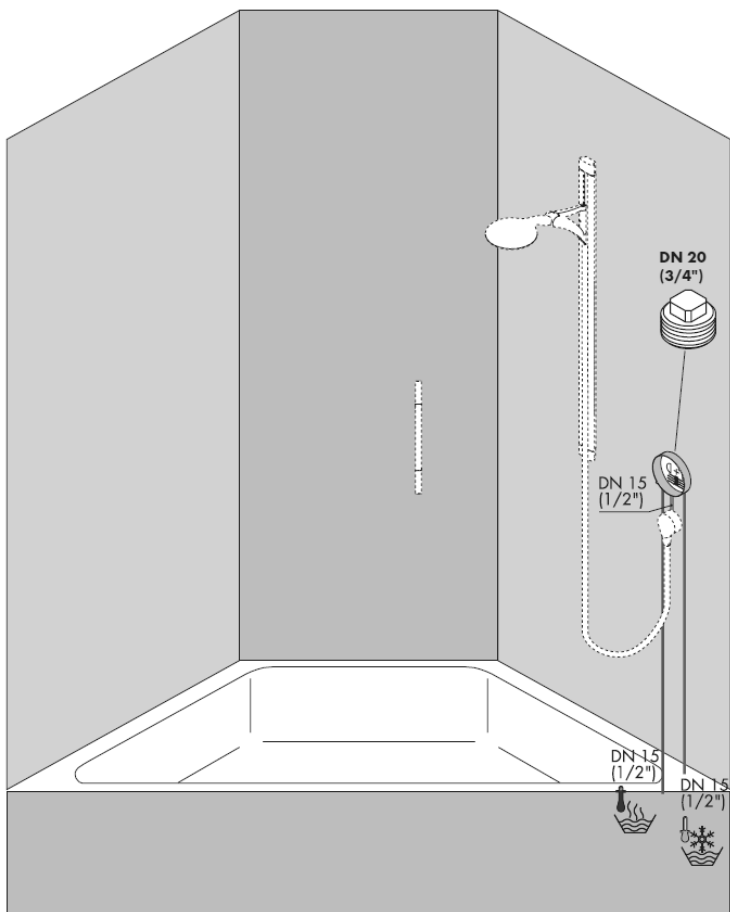

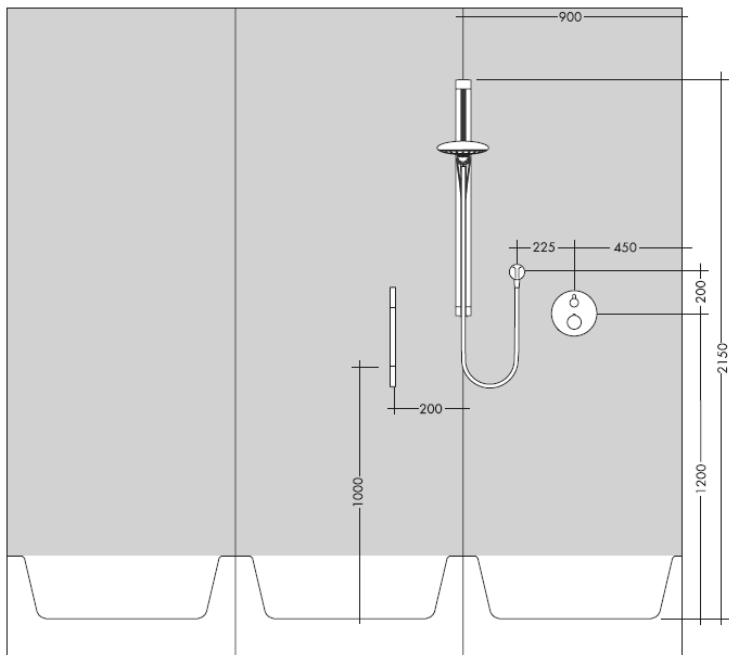
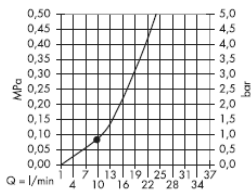
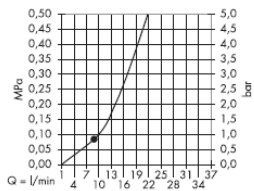

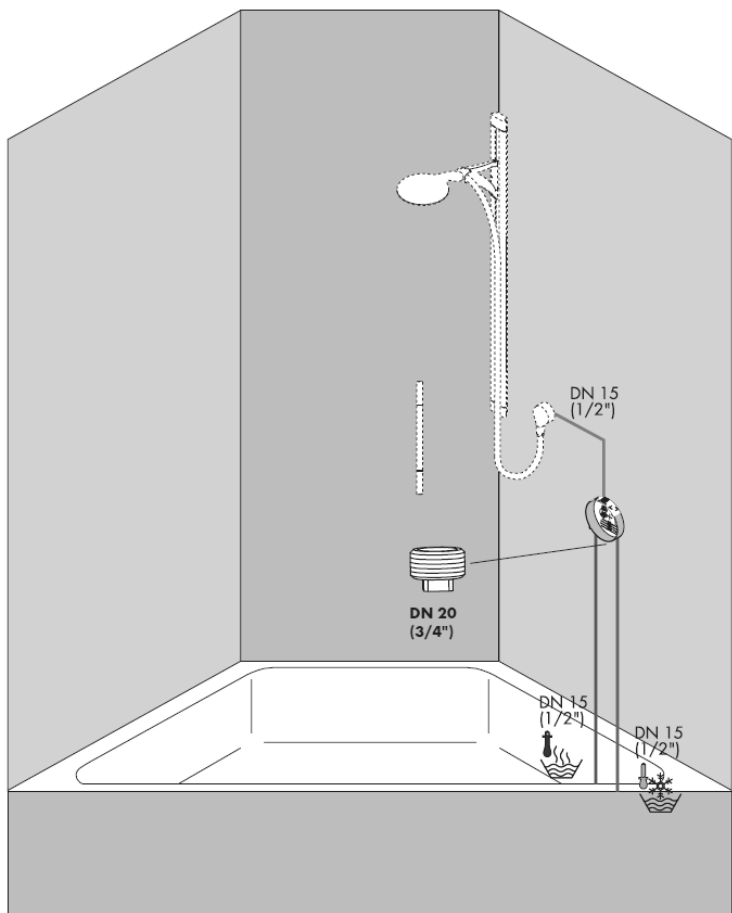

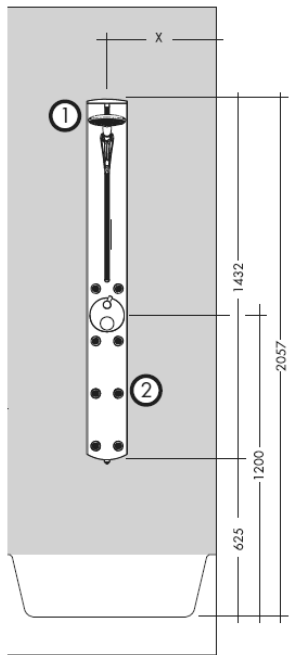
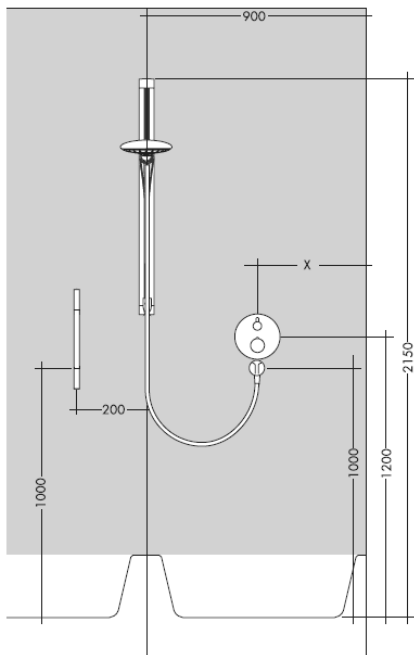
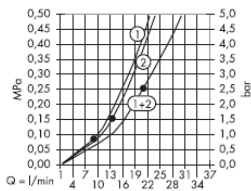
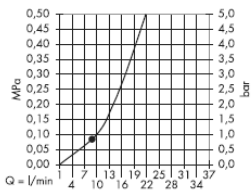

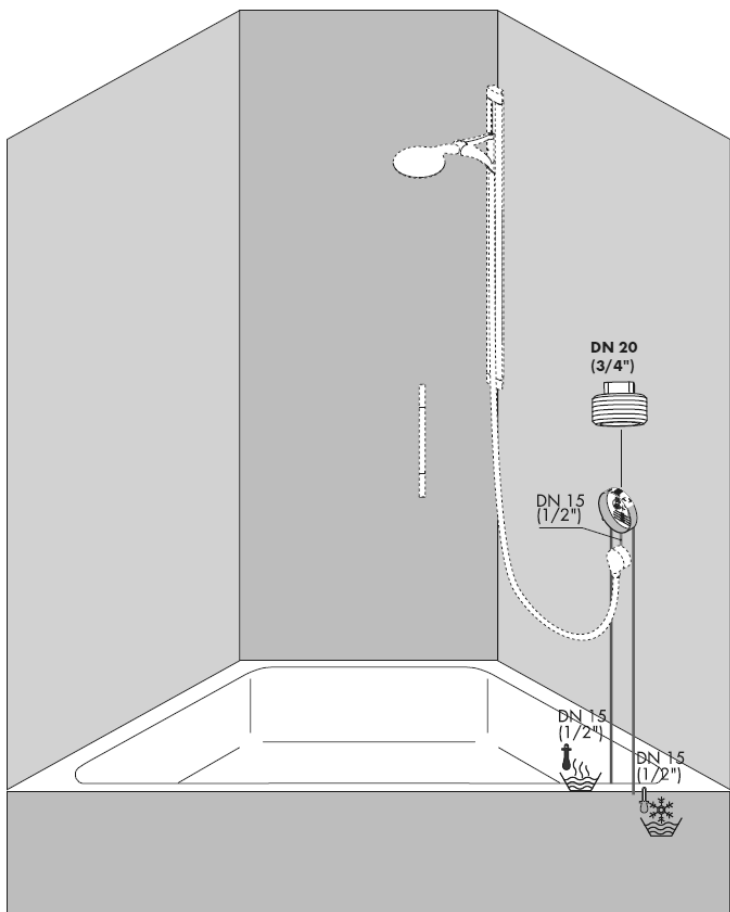

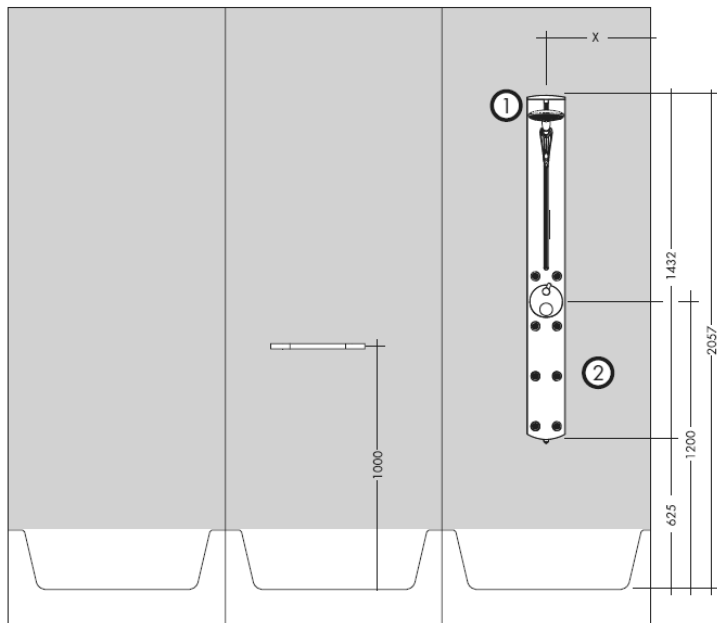
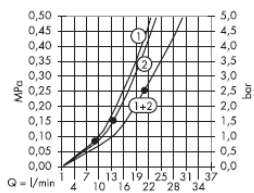

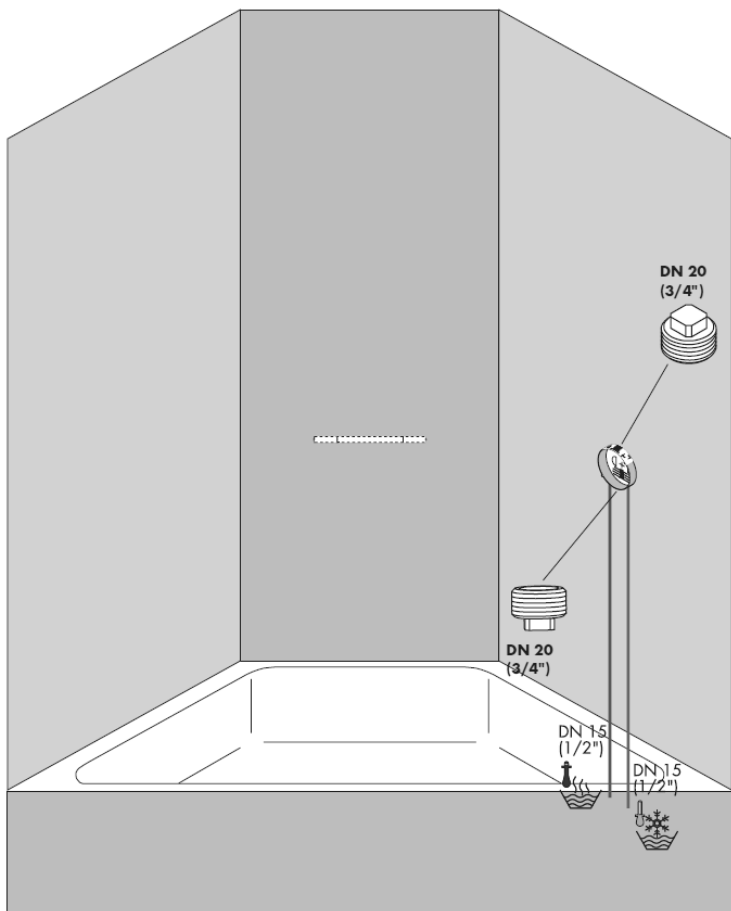

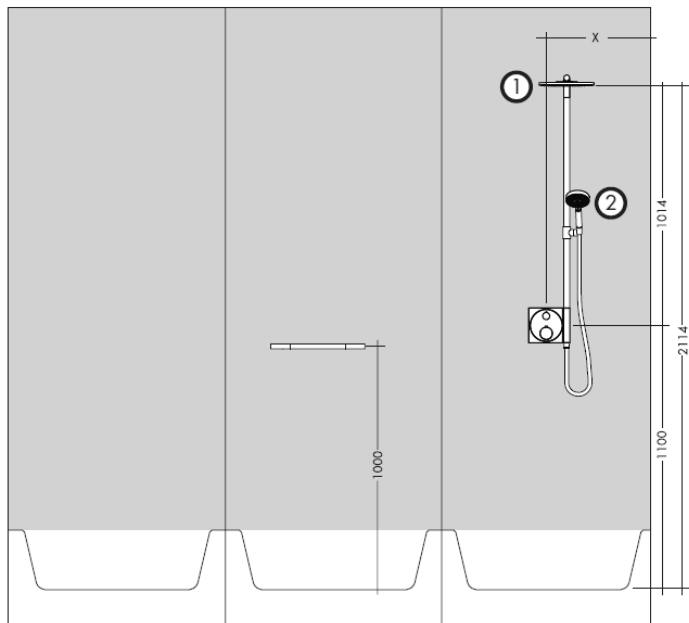
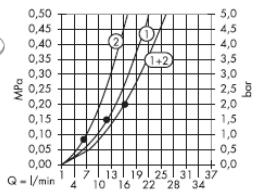

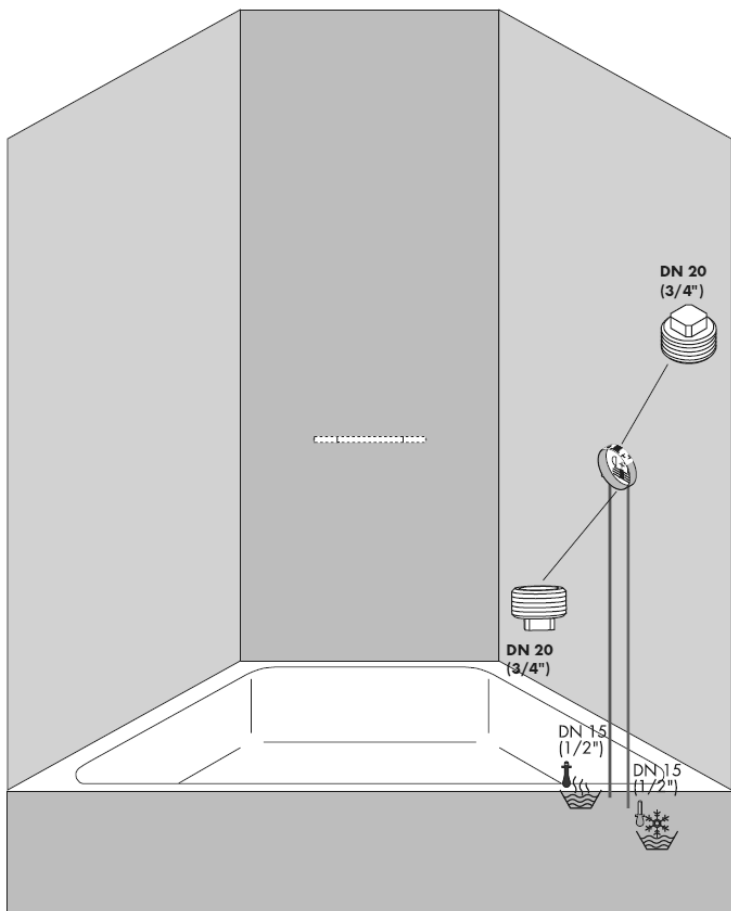

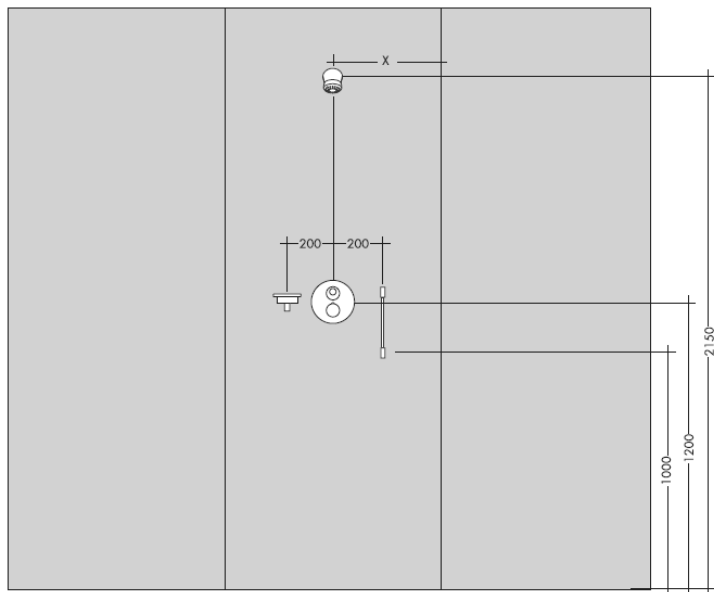
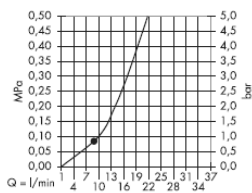
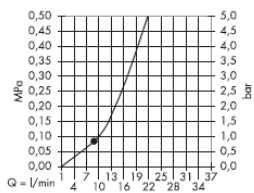

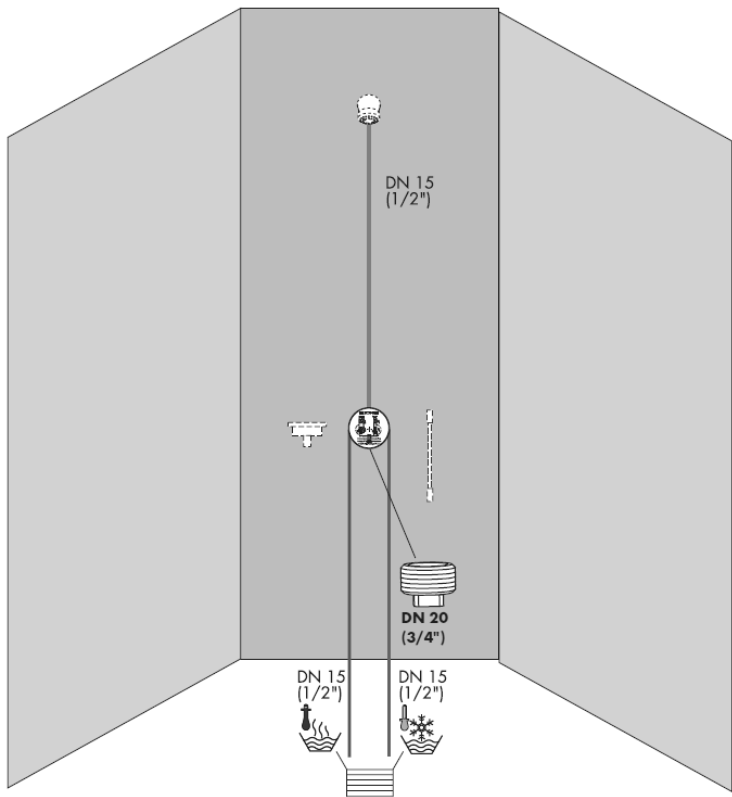

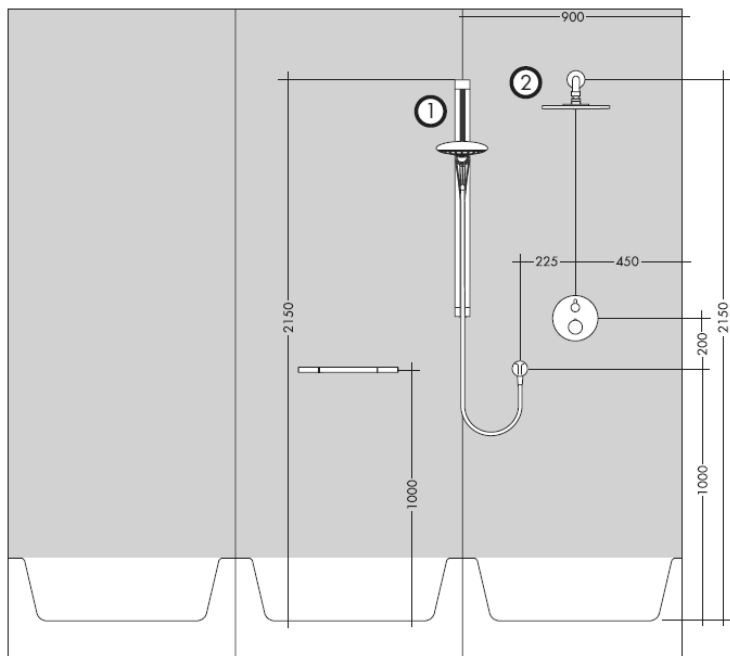
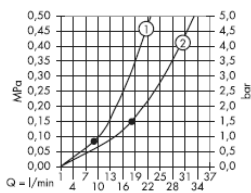
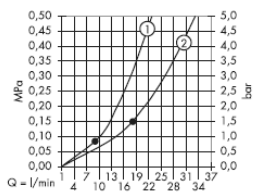
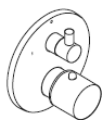

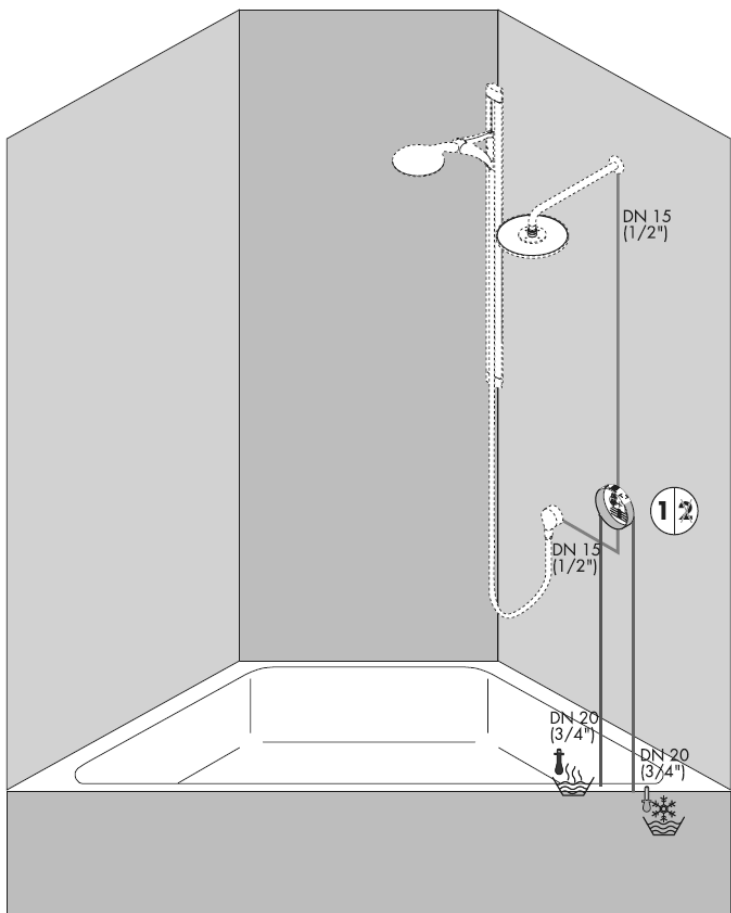

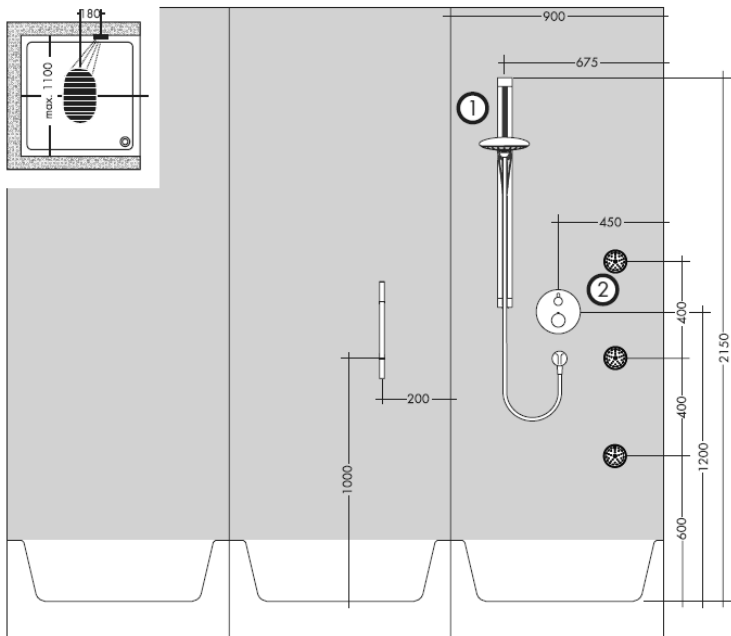
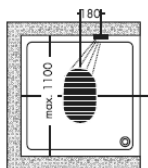
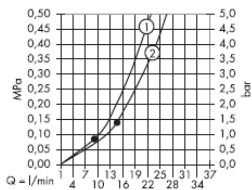
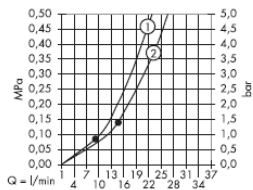

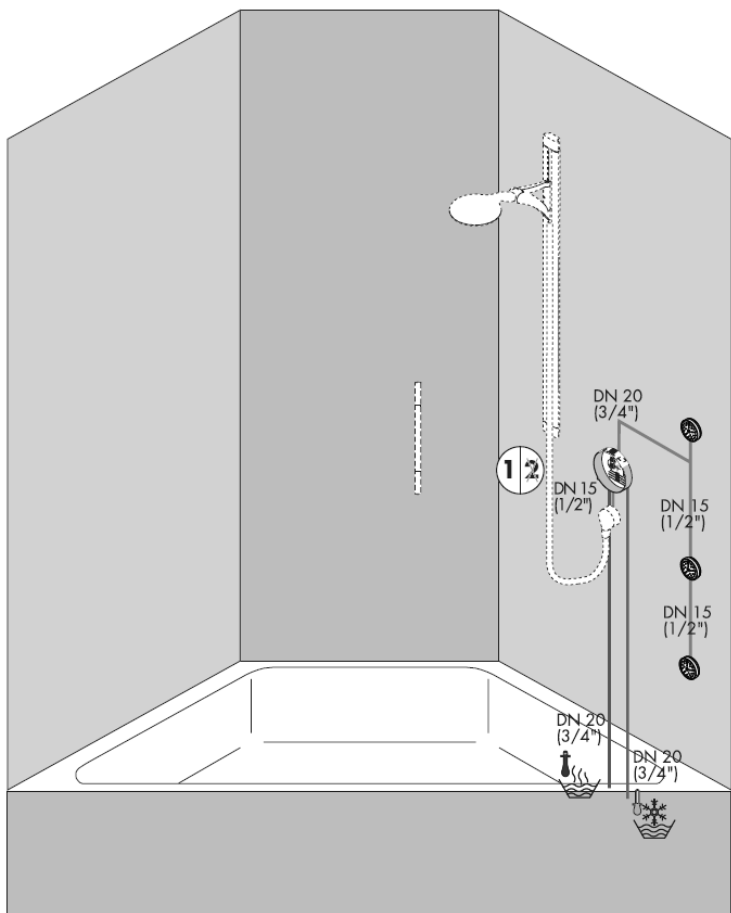

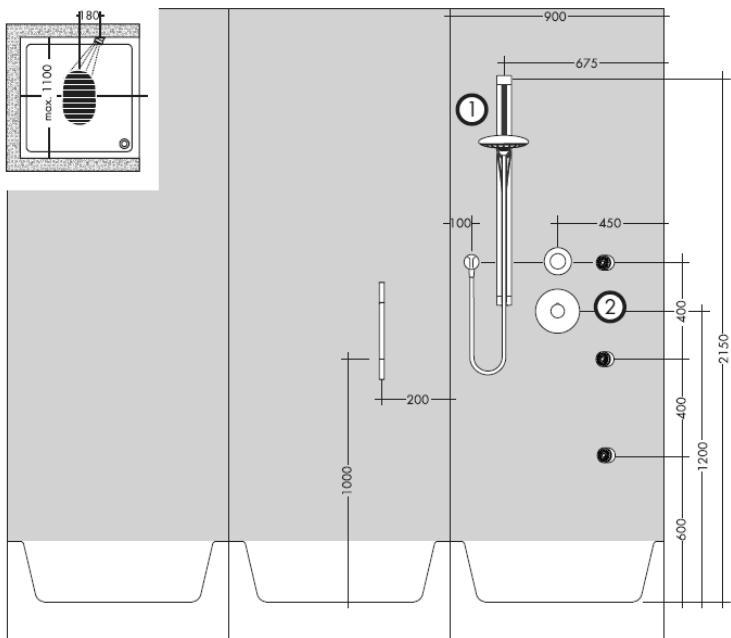
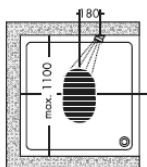
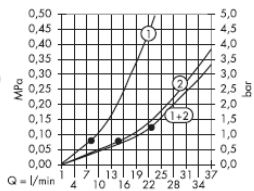

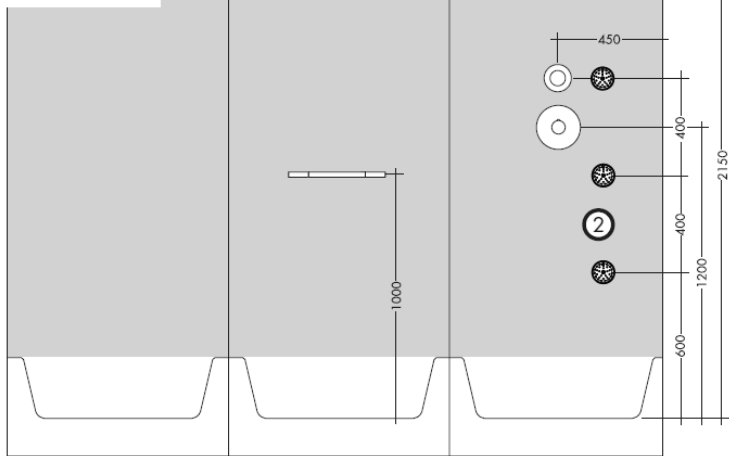
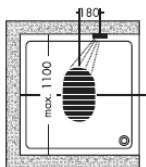
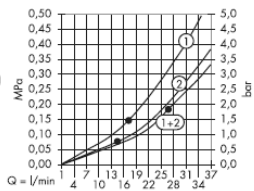

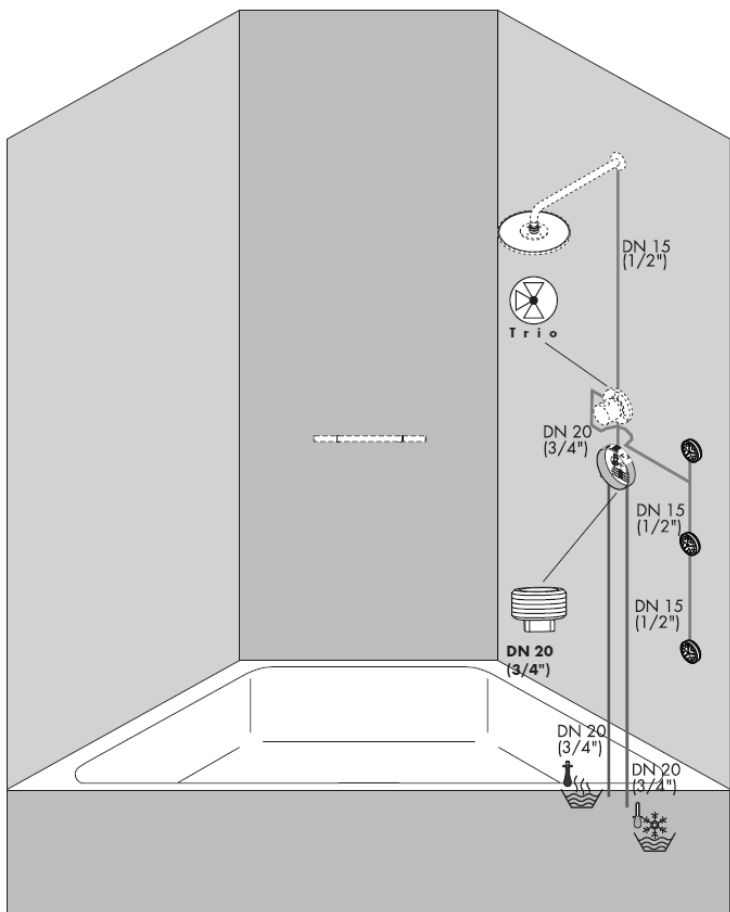

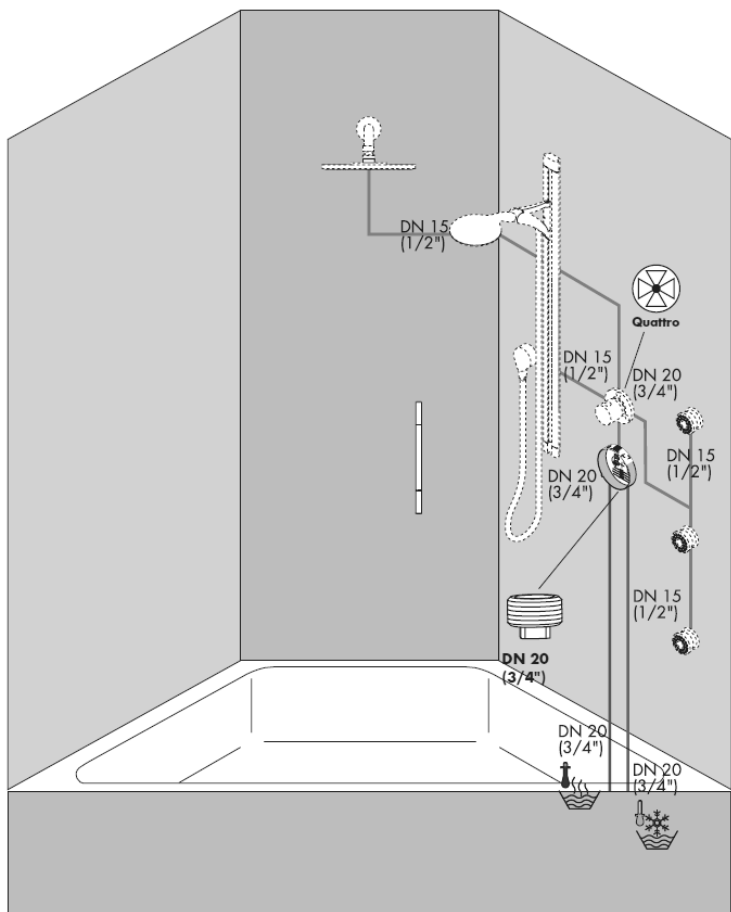

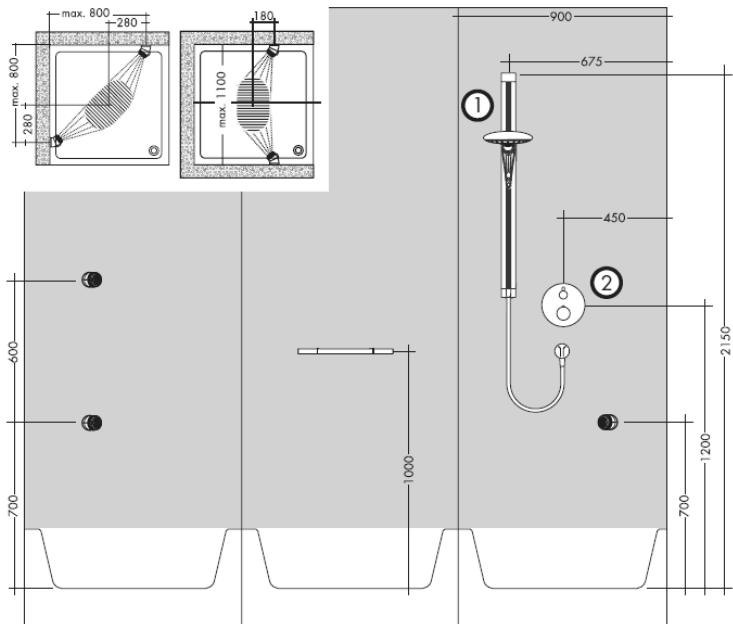
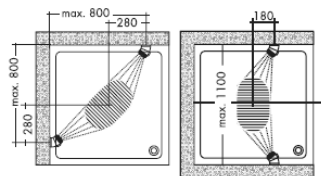
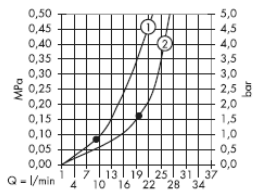
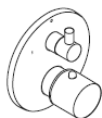

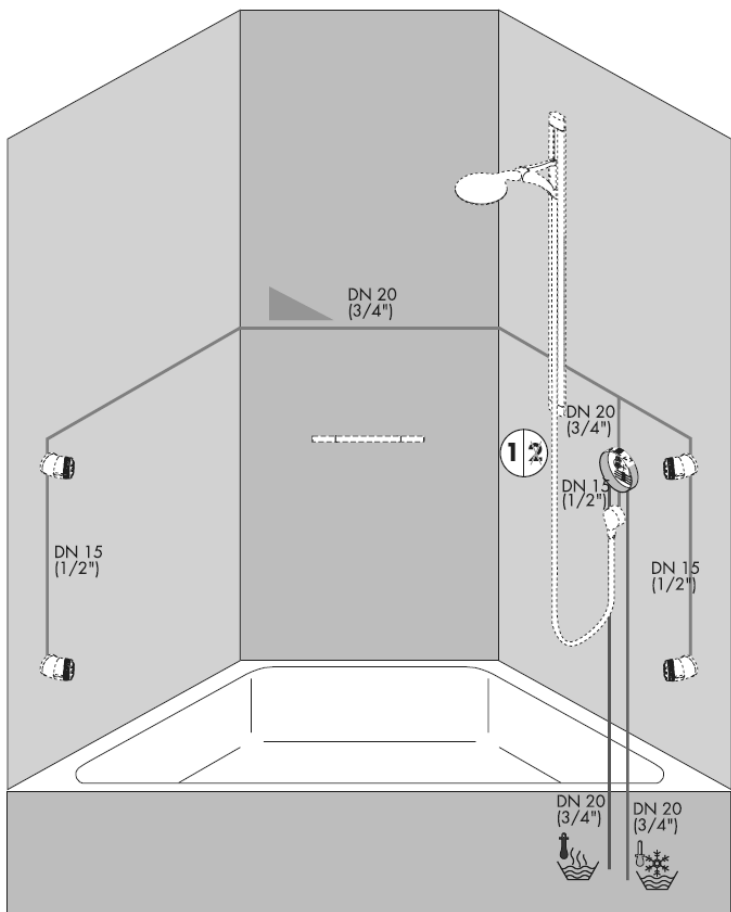

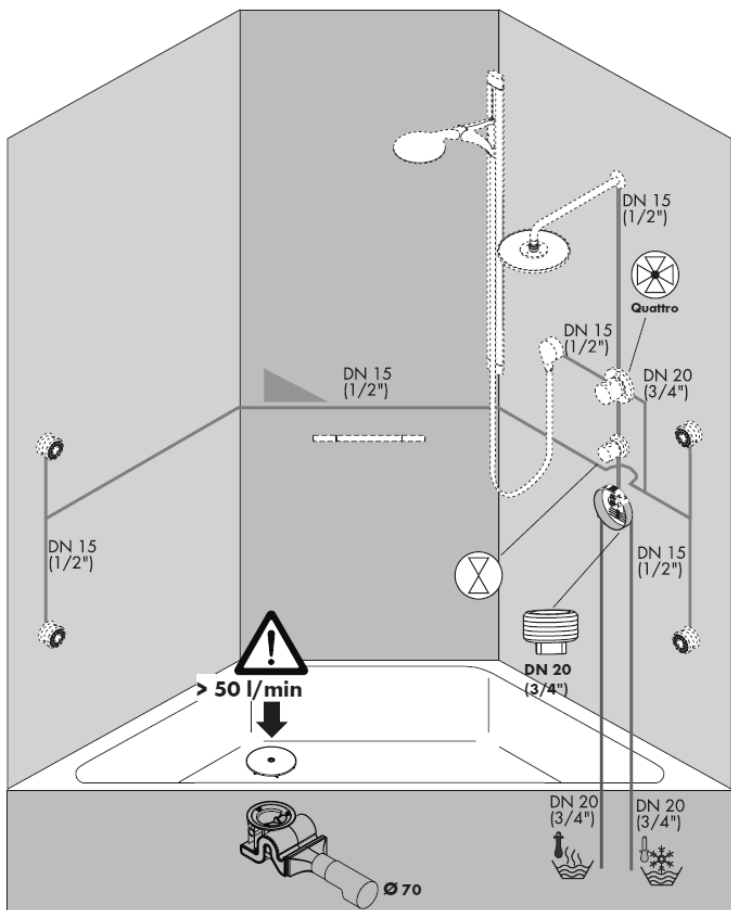

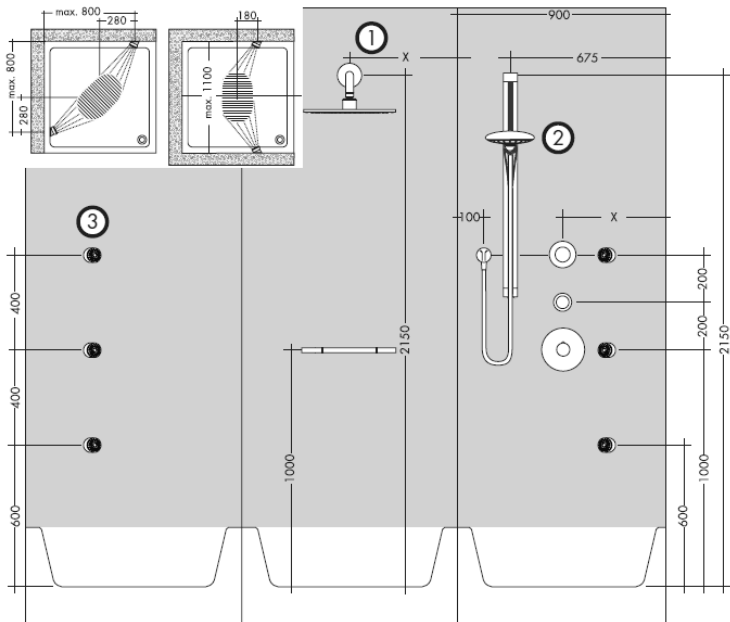
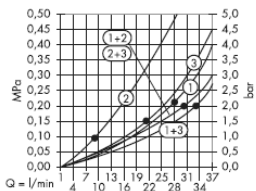

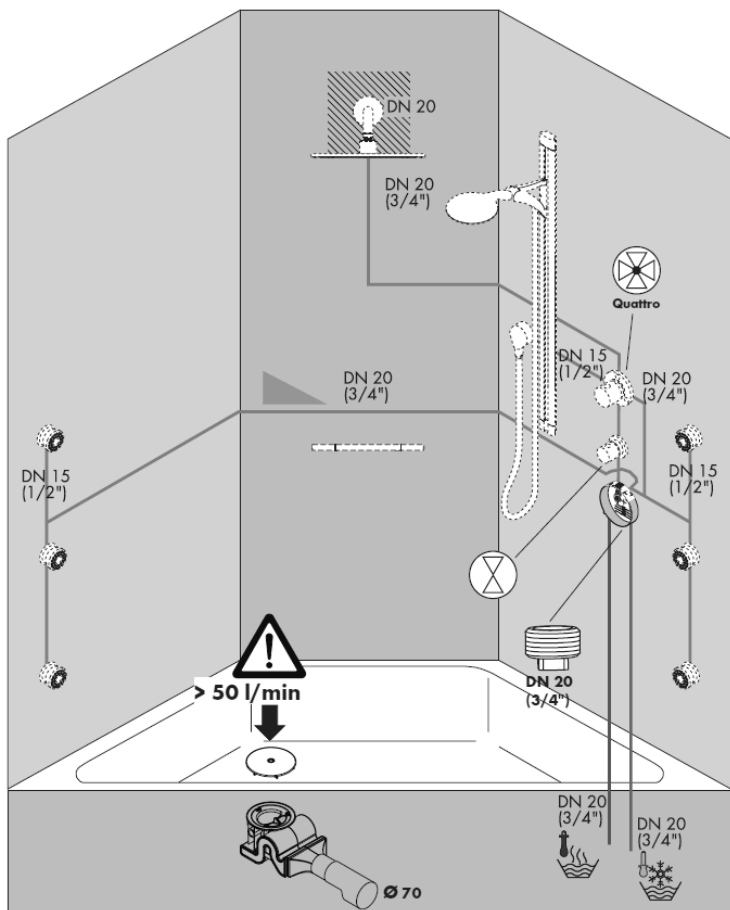

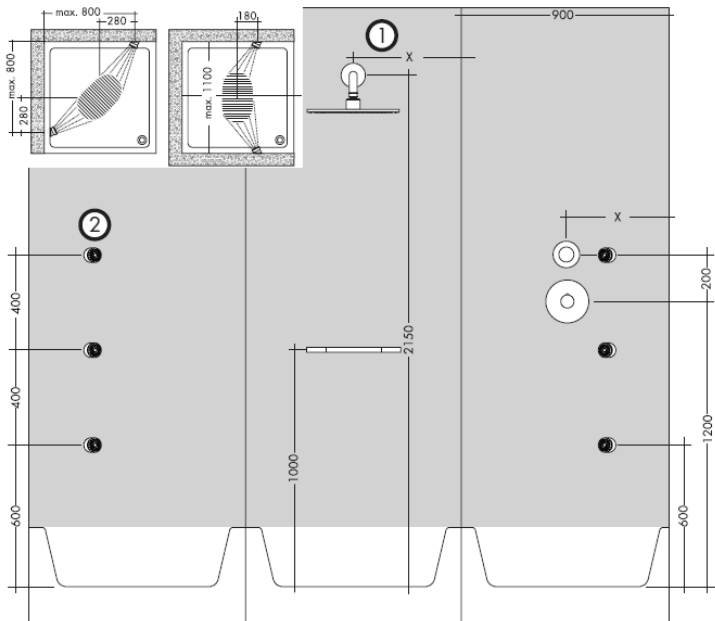
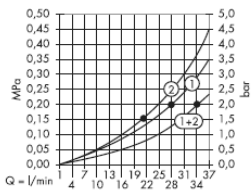

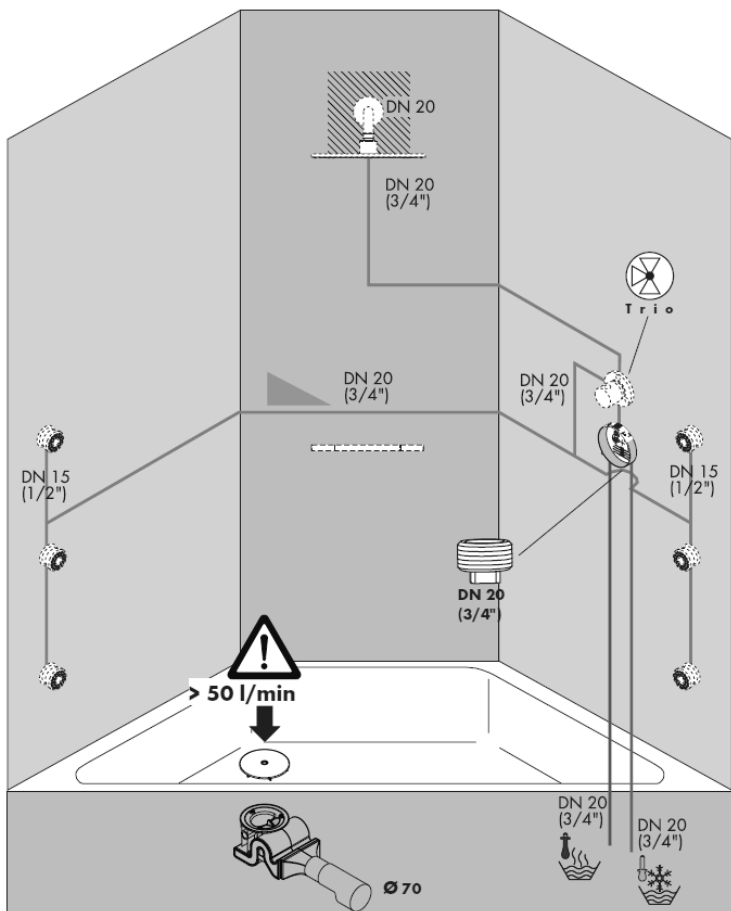

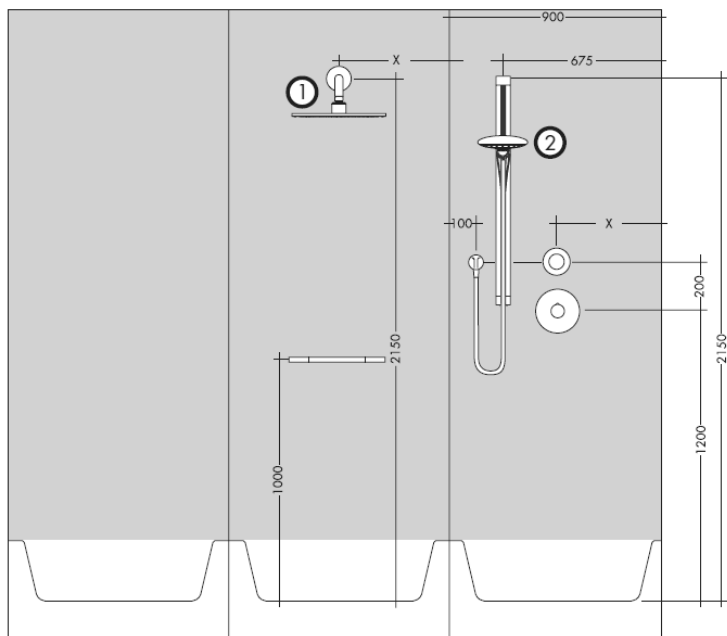
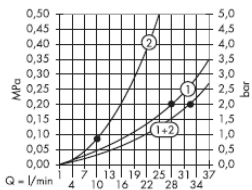

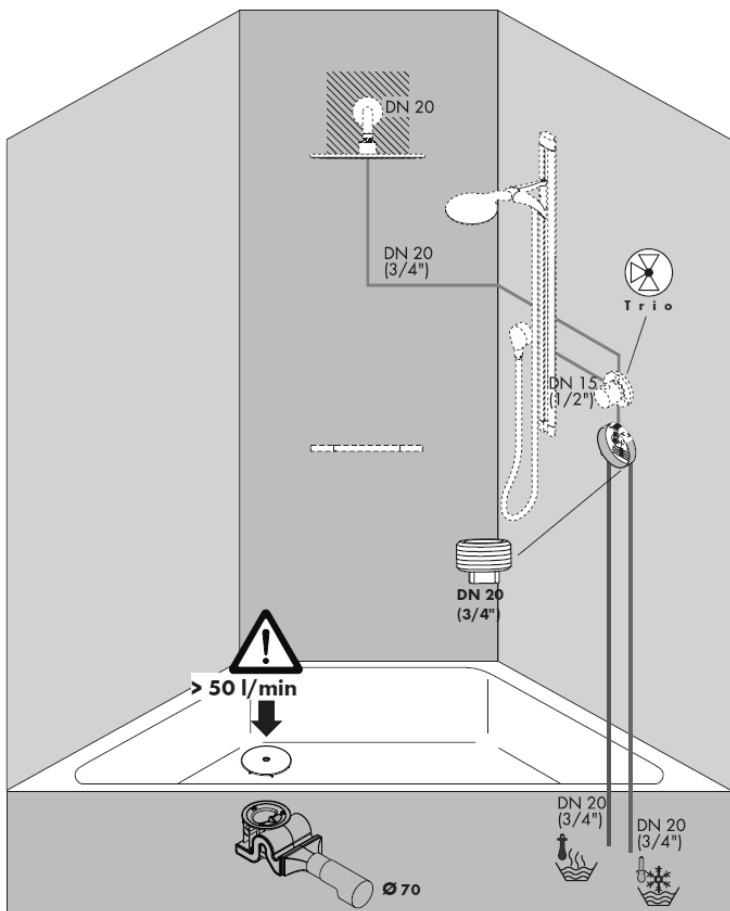

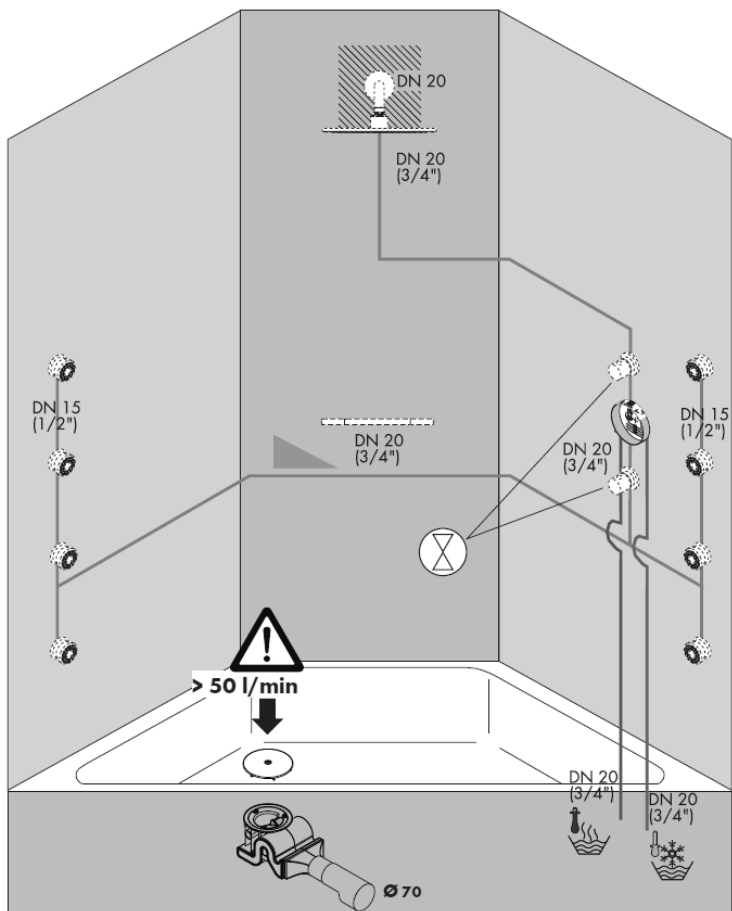

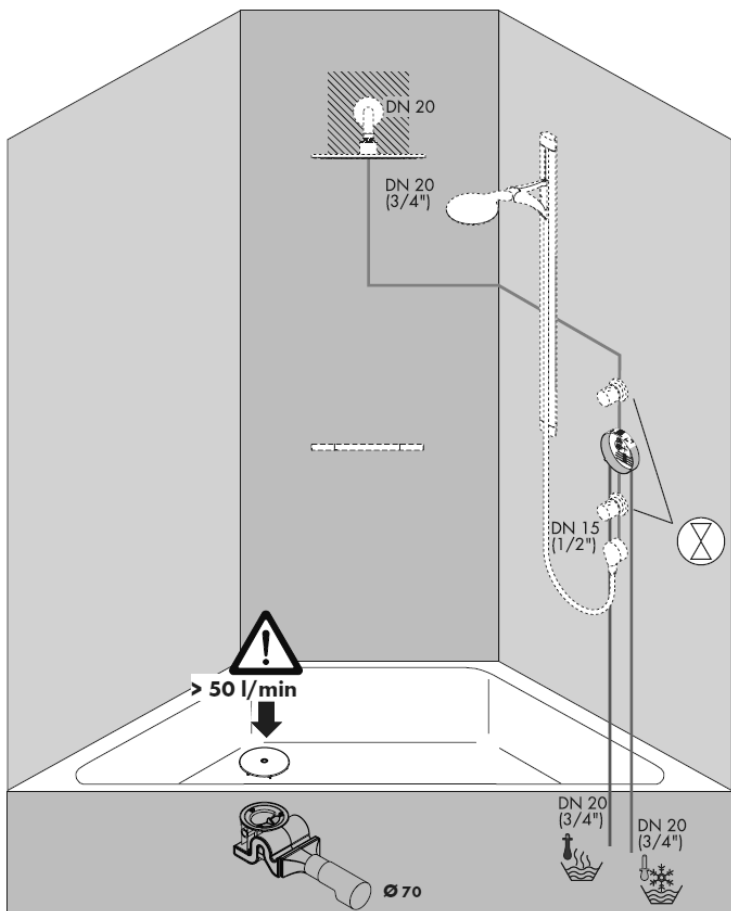

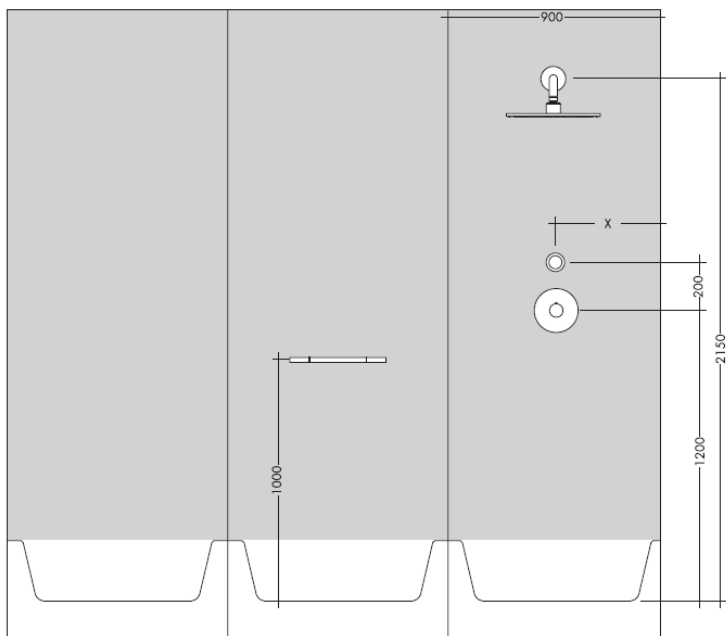
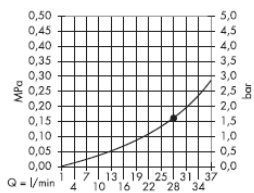

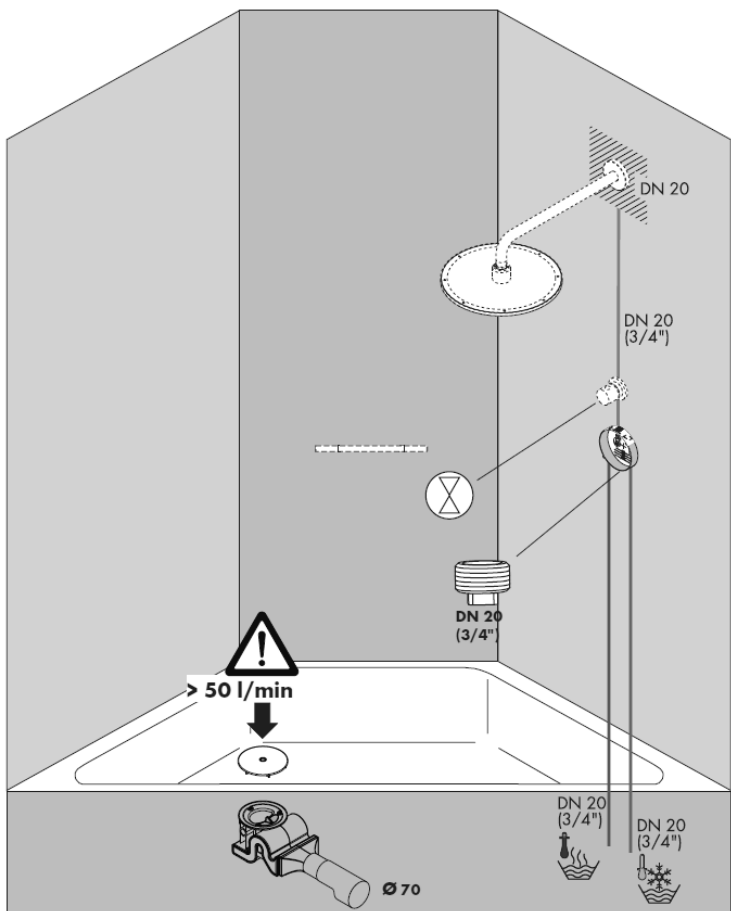

High
Flow

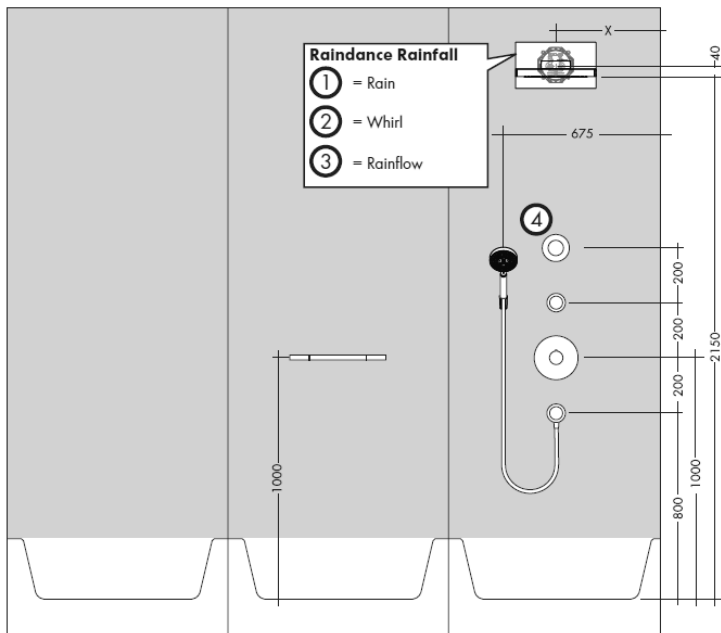
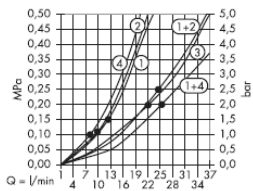
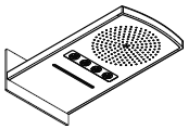

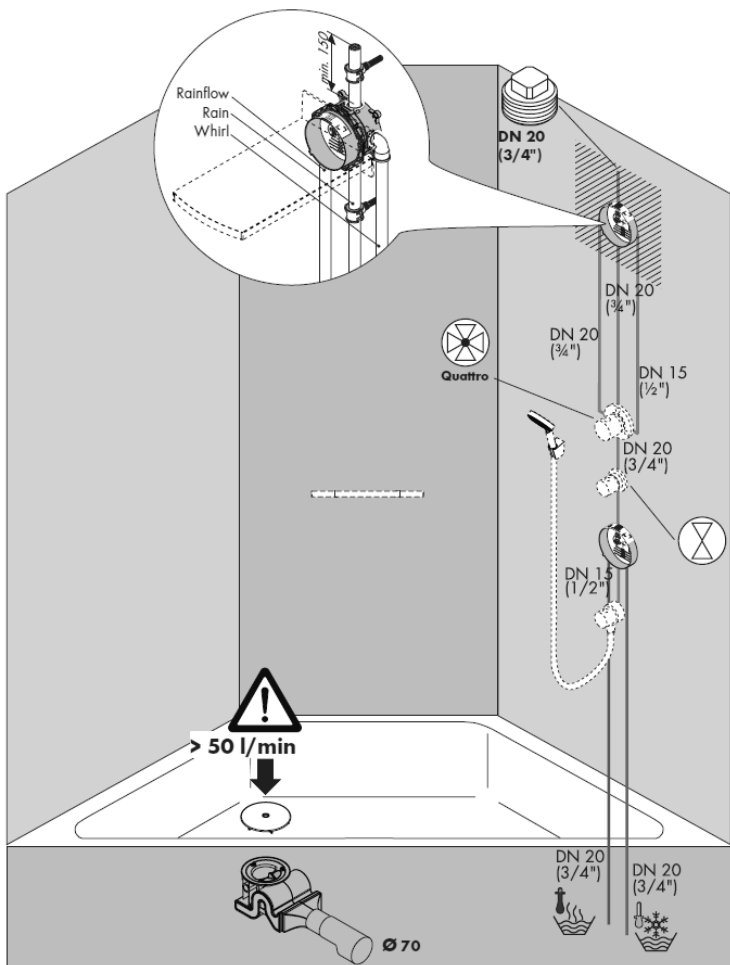

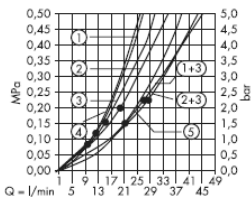

Raindance Rainmaker

- ① = Rain AIR
- ② = Rain AIR XXL
- ③ = Whirl AIR
- ①+③ = Rain AIR + Whirl AIR
- ②+③ = Rain AIR XXL + Whirl AIR

