

<b>DE</b>	Gebrauchsanleitung / Montageanleitung	<b>2</b>
<b>FR</b>	Mode d'emploi / Instructions de montage	<b>2</b>
<b>EN</b>	Instructions for use / assembly instructions	<b>3</b>
<b>IT</b>	Istruzioni per l'uso / Istruzioni per Installazione	<b>3</b>
<b>ES</b>	Modo de empleo / Instrucciones de montaje	<b>4</b>
<b>NL</b>	Gebruiksaanwijzing / Handleiding	<b>4</b>
<b>DK</b>	Brugsanvisning / Monteringsvejledning	<b>5</b>
<b>PT</b>	Instruções para uso / Manual de Instalação	<b>5</b>
<b>PL</b>	Instrukcja obsługi / Instrukcja montażu	<b>6</b>
<b>CS</b>	Návod k použití / Montážní návod	<b>6</b>
<b>SK</b>	Návod na použitie / Montážny návod	<b>7</b>
<b>ZH</b>	用户手册 / 组装说明	<b>7</b>
<b>RU</b>	Руководство пользователя / Инструкция по монтажу	<b>8</b>
<b>HU</b>	Használati útmutató / Szerelési útmutató	<b>8</b>
<b>FI</b>	Käyttöohje / Asennusohje	<b>9</b>
<b>SV</b>	Brugsanvisning / Monteringsanvisning	<b>9</b>
<b>LT</b>	Vartotojo instrukcija / Montavimo instrukcijos	<b>10</b>
<b>HR</b>	Upute za uporabu / Uputstva za instalaciju	<b>10</b>
<b>TR</b>	Kullanım kılavuzu / Montaj kılavuzu	<b>11</b>
<b>RO</b>	Manual de utilizare / Instrucțiuni de montare	<b>11</b>
<b>EL</b>	Οδηγίες χρήσης / Οδηγία συναρμολόγησης	<b>12</b>
<b>SL</b>	Navodilo za uporabo / Navodila za montažo	<b>12</b>
<b>ET</b>	Kasutusjuhend / Paigaldusjuhend	<b>13</b>
<b>LV</b>	Lietošanas pamācība / Montāžas instrukcija	<b>13</b>
<b>SR</b>	Uputstvo za upotrebu / Uputstvo za montažu	<b>14</b>
<b>NO</b>	Brugsanvisning / Montasjeveiledning	<b>14</b>
<b>BG</b>	Инструкция за употреба / Ръководство за монтаж	<b>15</b>
<b>SQ</b>	Udhëzuesi i përdorimit / Udhëzime rreth montimit	<b>15</b>
<b>AR</b>	دليل الاستخدام / تعليمات التجميع	<b>16</b>

**Logis**  
40511XXX

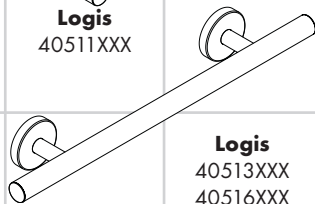

**Logis**  
40513XXX  
40516XXX

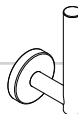

**Logis**  
40517XXX

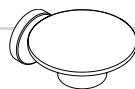

**Logis**  
40515XXX

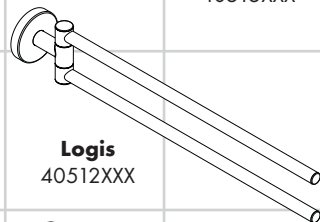

**Logis**  
40512XXX

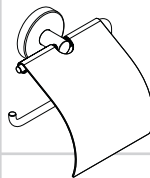

**Logis**  
40523XXX

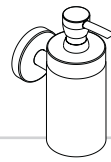

**Logis**  
40514XXX



**Logis**  
40518XXX

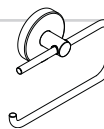



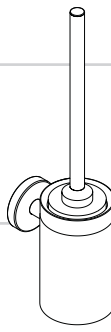

**Logis**  
40526XXX



**Logis**  
40522XXX



## Sicherheitshinweise

-  Bei der Montage müssen zur Vermeidung von Quetsch- und Schnittverletzungen Handschuhe getragen werden.
-  Bestimmungsgemäßer Gebrauch des Haltegriffes 40513XXX: Der Haltegriff ist kein medizinisches Produkt, er ist nicht für körperlich beeinträchtigte Personen geeignet, sondern nur für den privaten Bereich bestimmt.
-  Es darf ausschließlich nur der Haltegriff zum Festhalten benutzt werden, die übrigen Produkte sind für diesen Einsatzzweck nicht geeignet.
-  Die ordnungsgemäße Befestigung und der feste Sitz der montierten Produkte ist in periodischen Abständen (jährlich) zu überprüfen.

## Montagehinweise

Bei der Montage des Produktes durch qualifiziertes Fachpersonal ist darauf zu achten, dass die Befestigungsfläche im gesamten Bereich der Befestigung plan ist (keine vorstehenden Fugen oder Fliesenversatz), der Wandaufbau für eine Montage des Produktes geeignet ist und keine Schwachstellen aufweist. Die beigelegten Schrauben und Dübel sind nur für Beton geeignet. Bei anderen Wandaufbauten sind die Herstellerangaben des Dübelherstellers zu beachten.

## Symbolerklärung



Kein essigsäurehaltiges Silikon verwenden!



**Maße** (siehe Seite 16-17)

Mundgeblasene Teile - Maßabweichungen berechtigen nicht zu Reklamationen



**Serviceteile** (siehe Seite 20)





XXX = Farbcodierung  
000 = chrom  
820 = brushed nickel



**Reinigung** (siehe Seite 20) und beiliegende Broschüre

Zum Füllen und Reinigen Pumpe und Deckel abnehmen.

## Consignes de sécurité

-  Lors du montage, porter des gants de protection pour éviter toute blessure par écrasement ou coupure
-  Utilisation conforme de la poignée 40513XXX : la poignée n'est pas un ustensile médical et ne convient pas aux handicapés physiques ; elle est seulement destinée au domaine privé.
-  N'utiliser que la poignée pour se retenir, les autres produits ne convenant pas à cette utilisation.
-  Vérifier à intervalles réguliers (une fois par an) la fixation correcte et la bonne assise des produits montés

## Instructions pour le montage

Lors du montage du produit par un ouvrier qualifié, il faut faire attention à ce que la surface de fixation soit plane sur toute son étendue (aucun dépassement de joint ni de carrelage), que la construction de la paroi soit adaptée à l'installation du produit et surtout ne présente aucun point faible. Les vis et les chevilles fournies sont uniquement appropriées au béton. Pour les autres constructions, il faudra tenir compte des préconisations du fabricant de cheville.

## Description du symbole



Ne pas utiliser de silicone contenant de l'acide acétique!



**Dimensions** (voir page 16-17)

Pièce soufflée artisanalement - Les différences de dimension ne justifient pas une réclamation.



**Pièces détachées** (voir page 20)

XXX = Couleurs  
000 = chromé  
820 = brushed nickel







**Nettoyage** (voir page 20) et brochure ci-jointe

Retirer la pompe et le couvercle pour remplir et nettoyer.





## Safety Notes

-  Gloves should be worn during installation to prevent crushing and cutting injuries.
-  Intended use of the handle 40513XXX: The handle is not a medical product, it is not intended for physically impaired persons, but only for general private use.
-  Use only the handle for support, the remaining products are not intended to be used as supports.
-  Check the proper attachment and tight seating of the installed products periodically (annually).

## Installation Instructions

Where the contractor mounts the product, he should ensure that the entire area of the wall to which the mounting plate is to be fitted, is flat (no projecting joints or tiles sticking out), that the structure of the wall is suitable for the installation of the product and has no weak points. The enclosed screws and dowels are only suitable for concrete. For another wall constructions the manufacturer's indications of the dowel manufacturer have to be taken into account.

## Symbol description

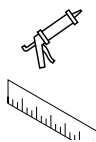

Do not use silicone containing acetic acid!

### Dimensions (see page 16-17)

The glass could be of a different size as illustrated due to it being blown by mouth.



### Spare parts (see page 20)





XXX = Colors  
000 = chrome plated  
820 = brushed nickel



### Cleaning (see page 20) enclosed brochure

Lift off pump and lid for filling and cleaning.

## Indicazioni sulla sicurezza

-  Durante il montaggio, per evitare ferite da schiacciamento e da taglio bisogna indossare guanti protettivi.
-  Impiego conforme all'uso dell'impugnatura 40513XXX: L'impugnatura non è un prodotto medico, non è adatto per persone disabili, bensì è destinato solo nell'ambito privato.
-  Per tenersi deve essere utilizzato esclusivamente l'impugnatura, gli altri prodotti non sono adatti per questo scopo d'impiego.
-  Il fissaggio a regola d'arte e la sede fissa dei prodotti montati va controllato a intervallo periodico (annualmente).

## Istruzioni per il montaggio

Quando il personale tecnico specializzato esegue il montaggio del prodotto è necessario assicurarsi che la superficie di fissaggio sia piana in tutta l'area di fissaggio (senza giunti sporgenti o spostamento delle piastrelle), che la struttura della parete sia adatta per il montaggio del prodotto e soprattutto che non ci siano dei punti deboli. Le viti e i tasselli in dotazione sono adatti solo per calcestruzzo. In caso di altre strutture della parete vanno osservare le indicazioni del produttore dei tasselli.

## Descrizione simbolo

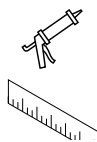

Non utilizzare silicone contenente acido acetico!

### Ingombri (vedi pagg. 16-17)

Pezzi soffiati – Non si accettano dei reclami a causa di tolleranze dimensionali



### Parti di ricambio (vedi pagg. 20)

XXX = Trattamento  
000 = cromato  
820 = brushed nickel



### Pulitura (vedi pagg. 20) e brochure allegata

Per riempire e pulire il contenitore togliere la pompa e il coperchio.





**Assembly (see page 18)**



**Montaggio (vedi pagg. 18)**



## Indicaciones de seguridad

-  Durante el montaje deben utilizarse guantes para evitar heridas por aplastamiento o corte.
-  Uso proyectado de la manilla 40513XXX: La manilla no es un producto médico, no es adecuado para personas con movilidad restringida sino destinada únicamente al ámbito privado.
-  Solo debe utilizarse exclusivamente la manilla para sujetarse, los demás productos no son adecuados para este uso.
-  Debe comprobarse en intervalos periódicos (anualmente) que los productos montados estén bien fijados y asentados.

## Indicaciones para el montaje

En el momento del montaje del producto por parte de personal especializado y cualificado se deberá prestar una atención especial a que la superficie de fijación en toda el área de la fijación sea plana (sin juntas que sobresalen ni azulejos desplazados), que la estructura de la pared sea adecuada para un montaje del producto y que, ante todo, no presente puntos débiles. Los tornillos y tacos adjuntos son sólo apropiados para hormigón. En el caso de otras estructuras murales se deberán considerar las indicaciones del fabricante de tacos.

## Descripción de símbolos



No utilizar silicona que contiene ácido acético!



### Dimensiones (ver página 16-17)

Piezas sopladas por la boca - Las diferencias de medida no dan derecho a reclamación



### Repuestos (ver página 20)





XXX = Acabados  
000 = cromado  
820 = brushed nickel



### Limpiar (ver página 20) y folleto anexo

Para llenar y limpiar quitar la bomba y la cobertera.

## Veiligheidsinstructies

-  Bij de montage moeten ter voorkoming van knel- en snijwonden handschoenen worden gedragen.
-  Reglementair gebruik van de handgreep 40513XXX: de handgreep is geen medisch product, hij is niet geschikt voor personen met een lichamelijke handicap en alleen bestemd voor privaat gebruik.
-  Alleen de handgreep mag gebruikt worden om zich vast te houden, de overige producten zijn voor dat gebruikdoeleinde niet geschikt.
-  De reglementaire bevestiging en de vaste zitting van de gemonteerde producten moet regelmatig (jaarlijks) gecontroleerd worden.

## Montage-instructies

Bij de montage van het produkt door een vakkundige installateur moet men erop letten dat het bevestigingsoppervlak op één oppervlak zit (dus geen opliggende voegen of verspringende tegels), de wand geschikt is voor montage van produkten en zeker geen zwakke plekken bevat. De bijgevoegde schroeven en duvels zijn alleen geschikt voor beton. Bei andere wandsoorten dient u te letten op de voorschriften van de fabrikant van de schroeven en duvels.

## Symboolbeschrijving



Gebruik geen zuurhoudende silicone!



### Maten (zie blz. 16-17)

Mondgeblazen materiaal - Maatafwijkingen rechtvaardigen geen reclamaties



### Service onderdelen (zie blz. 20)

XXX = Kleuren  
000 = verchromd  
820 = brushed nickel







### Reinigen (zie blz. 20) en bijgevoegde brochure

Voor het vullen en reinigen pompje en afdekrozet verwijderden.





### Sikkerhedsanvisninger

-  Ved monteringen skal der bruges handsker for at undgå kvæstelser og snitsår.
-  Formålstjenlig brug af håndtaget 40513XXX: Håndtaget er intet medicinsk produkt. Det er ikke beregnet til personer med handicap og kun til privat brug.
-  Man må udelukkende bruge håndtaget til at holde sig fast med. De øvrige produkter er ikke egnede til dette formål.
-  Den korrekte montering og position af monterede produkter skal kontrolleres i regelmæssige afstande (årligt).

### Monteringsanvisninger

Ved montering er det vigtigt at sikre sig, at hele befæstigelsesfladen er plan (ingen ujævne fuger eller fliser), samt at væggen er egnet til montering af produktet og specielt, at væggen ikke har nogen svage punkter. De medfølgende skruer og dübler er kun egnede til beton. Ved anden vægopbygning bør producenten af dübler kontaktes for nærmere information.

### Symbolbeskrivelse



Der må ikke benyttes eddikesyreholdig silikone!

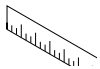

#### Målene (se s. 16-17)

Mundblæste dele - der kan ikke reklameres mod småafvigelser.



#### Reserve dele (se s. 20)





XXX = Overflade  
000 = Krom  
820 = Brushed nickel



#### Rengøring (se s. 20) og vedlagt brochure

Ved påfyldning og rengøring tag da pumpe og låget af.

### Avisos de segurança

-  Durante a montagem devem ser utilizadas luvas de protecção, de modo a evitar ferimentos resultantes de entalamentos e de cortes.
-  Utilização adequada da pega 40513XXX: A pega não é nenhum produto do foro médico e não é adequado para pessoas com deficiências ou debilitações motoras. Esta destina-se apenas para a utilização privada.
-  Para se segurar ou apoiar só pode utilizar a pega, visto os outros produtos não serem adequados para esse fim.
-  A fixação e encaixe correctos dos produtos montados devem ser verificados periodicamente (anualmente).

### Avisos de montagem

Durante a montagem do produto por técnicos qualificados, deve ter-se em atenção que a superfície de fixação seja plana em toda a área da fixação (sem juntas sobrepostas/salientes ou ladrilhos deslocados), que o dispositivo de montagem na parede seja adequado para uma montagem na parede e que este não apresente nenhuns pontos fracos. Os parafusos e buchas incluídos no volume de fornecimento são apenas adequados para betão. Para outros métodos de montagem na parede devem ser respeitadas as indicações do fabricante das buchas.

### Descrição do símbolo



Não utilizar silicone que contenha ácido acético!

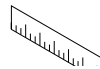

#### Medidas (ver página 16-17)

O vidro poderá apresentar diferenças em relação ao ilustrado devido ao facto de ser feito por sopro.



#### Peças de substituição (ver página 20)

XXX = Acabamentos  
000 = cromado  
820 = brushed nickel







#### Limpeza (ver página 20) e brochura em anexo

Retirar a bomba e a cobertura para encher e limpar.





## Wskazówki bezpieczeństwa

-  Aby uniknąć zranień, takich jak zgniecenia czy przecięcia, podczas montażu należy nosić rękawice.
-  Użytkowanie uchwytu 40513XXX zgodne z przeznaczeniem: Uchwyt nie jest produktem medycznym, nie jest on przeznaczony dla osób niepełnosprawnych o utrudnionym poruszaniu się, lecz jedynie do użytku prywatnego.
-  Do trzymania się może być używany jedynie uchwyt; pozostałe produkty nie nadają się do tego celu.
-  W określonym czasie (co roku) należy sprawdzać właściwe zamocowanie i odpowiednie osadzenie zamontowanych produktów.

## Wskazówki montażowe

Przy montażu produktu przez wykwalifikowany personel fachowy należy zważać na to, by powierzchnia mocowania na całym obszarze mocowania była równa (by nie było szczelin wzgl. wzajemnie przesuniętych płytek), rodzaj ściany nadawał się do montażu produktu i zwłaszcza, by nie było żadnych słabych stron.

Umieszczone w dostawie śruby i kołki rozporowe są przeznaczone tylko do betonu. Przy innych rodzajach montażu ścianowego należy przestrzegać danych producenta kołków rozporowych.

## Opis symbolu



Nie stosować silikonów zawierających kwas octowy!



### Wymiary (patrz strona 16-17)

Ustnie dmuchane elementy – różnice w wymiarach nie podlegają reklamacji



### Części serwisowe (patrz strona 20)





XXX = kody wykończenia powierzchni  
000 = chrom  
820 = nikiel szorowany



### Czyszczenie (patrz strona 20) i dołączona broszura

Do napełniania i czyszczenia pompy zdjąć klapkę.

## Bezpečnostní pokyny

-  Pro zabránění řezným zraněním a pohmožděním je nutné při montáži nosit rukavice.
-  Použití držáku 40513XXX v souladu s určením: Držák není žádný medicínský produkt, není vhodný pro tělesně postižené osoby, je určen pouze pro soukromý sektor.
-  K držení se smí používat výlučně držák, ostatní produkty nejsou vhodné pro tento účel použití.
-  Upevnění podle předpisů a pevné usazení montovaných produktů je třeba kontrolovat v periodických časových intervalech (ročně).

## Pokyny k montáži

Při montáži produktu kvalifikovaným odborným personálem je třeba dbát na to, aby upevňovací plochy byly v celém rozsahu upevnění rovné (žádné vyčnívající spáry nebo navzájem přesazené obklady), aby konstrukce stěny byla pro montáž produktu vhodná a zvláště aby v ní nebyla žádná slabá místa. Příkladné vruty a hmoždinky jsou vhodné pouze pro beton. Při jiných konstrukčních materiálech stěny je třeba se řídit údaji výrobce hmoždinek.

## Popis symbolů



Nepoužívat silikon s obsahem kyseliny octové!



### Rozměry (viz strana 16-17)

Ručně foukané sklo - rozdíly v rozměrech neopravňují k reklamacji



### Servisní díly (viz strana 20)

XXX = kód povrchové úpravy  
000 = chrom  
820 = brushed nickel







### Čištění (viz strana 20) a příložená brožura

K naplnění a čištění čerpadla sejmout víko.





## **Bezpečnostné pokyny**

-  Pri montáži musíte nosiť rukavice, aby ste predišli pomliaždeninám a rezným poraneniam.
-  Použitie držiaka 40513XXX podľa určenia: Držiak nie je žiaden lekársky produkt, nie je vhodný pre telesne postihnuté osoby, je určený iba pre súkromný sektor.
-  Na držanie sa smie používať výlučne držiak, ostatné produkty nie sú vhodné na tento účel použitia.
-  Upevnenie podľa predpisov a pevné osadenie montovaných produktov treba kontrolovať v periodických časových intervaloch (ročne).

## **Pokyny pre montáž**

Pri montáži produktu kvalifikovaným odborným personálom je nutné dbať na to, aby upevňovacie plochy boli v celom rozsahu upevnenia rovné (žiadne výčnievajúce škáry alebo navzájom predsadené obklady), aby konštrukcia steny bola pre montáž produktu vhodná a zvlášť aby v nej neboli žiadne slabé miesta. Priložené vruty a hmoždinky sú vhodné len pre betón. Pri iných konštrukčných materiáloch steny je nutné riadiť sa údajmi výrobcu hmoždiniek.

## **Popis symbolov**

 Nepoužívať silikón s obsahom kyseliny octovej!

 **Rozmery** (viď strana 16-17)

Sklo má byť inej veľkosti než je zobrazené, lebo sa vyfukuje ústami. Nie je nárok na reklamáciu.





 **Servisné diely** (viď strana 20)

XXX = kód povrchovej úpravy  
000 = chróm  
820 = brushed nickel

 **Čistení** (viď strana 20) a priložená brožúra

Pri plnení a čistení čerpadla odoberte veko.

## **安全技巧**

-  装配时为避免挤压和切割受伤，必须戴上手套。
-  按规定使用握柄40513XXX：握柄乃非医疗产品，它不适用于身体受到损害的人员，而只适用于私人范畴。
-  握柄只用于握持，其它产品不适用于此项使用用途。
-  应定期（每年）检查已装配好的产品是否正常固定和固定定位。

## **安装提示**

在安装产品的位置，安装人员必须确保安装面的墙面是平的（没有突出物或瓷砖没有突起），墙体结构适合产品的安装并没有弱点。包装内的膨胀螺丝只适用于混凝土墙体。对于其他墙体结构必须咨询膨胀螺丝生产商的建议。

## **符号说明**

 请勿使用含有乙酸的硅！

 **大小** (参见第 16-17 页)

玻璃由于使用嘴吹开的，所以尺寸可能与图示不同。

 **备用零件** (参见第 20 页)

XXX = 颜色代码  
000 = 镀铬  
820 = 镍拉丝

 **清洗** (参见第 20 页) 并附有小手册

高泵和盖子，用于加注和排放。





**Montáž (viď strana 18)**



**安装 (参见第 18 页)**



## Указания по технике безопасности

-  Во время монтажа следует надеть перчатки во избежание прищемления и порезов.
-  Применение по назначению рукоятки 40513XXX: рукоятка не является медицинским оборудованием, она не предназначена для использования людьми с физическими недостатками, предназначена только для частного использования.
-  Для фиксации разрешается использовать исключительно рукоятку, остальные изделия непригодны для этой цели.
-  Надлежащее крепление и плотность посадок установленных изделий следует проверять регулярно (ежегодно).

## Указания по монтажу

При монтаже изделия квалифицированным персоналом необходимо следить за тем, чтобы, поверхность крепления была плоской во всей зоне крепления (без выступающих швов или смещения плитки), структура стен подходила для монтажа изделия и, в частности, не имела слабых мест. Прилагаемые винты и дюбели предназначены только для бетона. При других типах стен необходимо соблюдать указания производителей дюбелей.

## Описание символов

 Не применяйте силикон, содержащий уксусную кислоту.

**Размеры** (см. стр. 16-17)

 Делали выполнены способом ручного дуля - отклонения размеров не являются основанием для рекламаций





 **Комплект** (см. стр. 20)

XXX = Код цвета поверхности  
000 = хром  
820 = brushed nickel

 **Очистка** (см. стр. 20) и прилагаемая брошюра

Для наполнения и очистки снимите насос и крышку.

## Biztonsági utasítások

-  A szerelésnél a zúródások és vágási sérülések elkerülése érdekében kesztyűt kell viselni.
-  A 40513XXX kapaszkodó rendeltetésszerű használata: A kapaszkodó nem orvosi termék, nem alkalmas testileg sérült személyek számára, hanem csak privát használatra szolgál.
-  Kapaszkodáshoz kizárólag csak a kapaszkodót szabad használni, a további termékek nem alkalmasak ilyen jellegű használatra.
-  A felszerelt termékek szabályszerű rögzítését és szilárd elhelyezkedését rendszeres időközönként (évente) ellenőrizni kell.

## Szerelési utasítások

Miközben szakképzett szakember végzi a termék felszerelését, ügyelni kell arra, hogy a rögzítési felületek a rögzítési terület teljes egészén síkok (nincsenek kiálló fugák vagy csempezések), a fal felépítése alkalmas a termék felszereléséhez, és különösképpen, hogy nincsenek benne gyenge pontok. A mellékelt csavarok és dübelek csak betonhoz alkalmasak. Egyéb falazatoknál figyelembe kell venni a dűbelgyártó gyártói utasításait.

## Szimbólumok leírása

 Ne használjon ecetsavtartalmú szilikon!

**Méretet** (lásd a 16-17. oldalon)

 Fúvott alkatrészek - a méretbeli eltérések nem jogosítanak fel reklamációra.

 **Tartozékok** (lásd a 20. oldalon)

XXX = Színkódok  
000 = króm  
820 = brushed nickel

 **Tisztítás** (lásd a 20. oldalon) és mellékelt brosúrával





A töltéshez és tisztításhoz vegye le a szivattyút és a fedelet.







## Turvallisuusohjeet

-  Asennuksessa on käytettävä käsineitä puristumien ja viiltojen aiheuttamien tapaturmien estämiseksi.
-  Kahvan 40513XXX tarkoituksenmukainen käyttö: Kahva ei ole lääkinällinen tuote. Se ei sovi ruumiillisesti rajoitteisten henkilöiden käyttöön, vaan se on tarkoitettu käytettäväksi yksityistiloissa.
-  Vain kahvaa saa käyttää kiinnittämiseen, muut tuotteet eivät sovi käytettäväksi siihen tarkoitukseen.
-  Asennettujen tuotteiden asianmukainen kiinnitys ja tiukkuus on tarkastettava säännöllisin väliajoin (vuosittain).

## Asennusohjeet

Kun pätevä ammattihenkilöstö suorittaa tuotteen asennusta, on huomioitava, että kiinnityspinta on koko kiinnityksen alueella tasainen (ei ulkonevia saumoja tai laattojen tasomuutoksia) ja, että seinän rakenne soveltuu tuotteen asentamiseen eikä siinä ole heikkoja kohtia. Mukana olevat kiinnitysruuvit ja kiinnitysankkurit soveltuvat betoniin kiinnittämiseen. Kiinnitettäessä tuotetta muihin seinärakenteisiin, noutata kiinnittimien valmistajan ohjeita.

## Merkin kuvaus



Älä käytä etikkahappopitoista silikonia!



### Mitat (katso sivu 16-17)

Käsinpuhalletut osat - mittapoikkeamat eivät ole peruste reklamaation tekemiselle.



### Varaosat (katso sivu 20)





XXX = Värikoodi  
000 = kromi  
820 = harjattu nikkeli



### Puhdistus (katso sivu 20) ja oheinen esite

Poista pumppu ja kansi täyttöä ja puhdistusta varten.

## Säkerhetsanvisningar

-  Handskar ska bäras under monteringsarbetet så att man kan undvika kläm- och skärskadorgen werden.
-  Avsedd användning av handtag 40513XXX: Handtaget är ingen medicinsk produkt och det är inte lämpligt för handikappade utan endast avsett för privat användning.
-  Det är bara handtaget som får användas till att hålla fast sig i. Övriga produkter är inte lämpliga till detta.
-  Alla monterade produkter ska kontrolleras regelbundet (varje år) så att de sitter fast ordentligt.

## Monteringsanvisningar

När kvalificerad fackpersonal monterar produkten är det viktigt att tänka på att monteringsytan är plan i alla delar av arbetsytan (inga fogar som sticker ut eller klinkerförskjutningar), att väggkonstruktionen passar till montering av produkten samt att den inte har svaga punkter. Medföljande skruvar och plugg är endast avsedda för betong. Vid andra väggkonstruktioner skall anvisningarna från pluggtillverkaren beaktas.

## Simbolio aprašymas



Använd inte silikon som innehåller ättiksyra!



### Måtten (se sidan 16-17)

Handtillverkade delar - mätavikelser berättigar inte till reklamationer



### Reservdelar (se sidan 20)

XXX = Färgkodning  
000 = krom  
820 = borstad nickel







### Rengöring (se sidan 20) och medföljande broschyr

Tag bort pump och lock för att fylla och rengöra.

## Asennus (katso sivu 18) Montering (se sidan 18)



## Saugumo technikos nurodymai

-  Apsaugai nuo užspaudimo ir įsijovimo montavimo metu mūvėkite pirštines.
-  Rankenos naudojimas pagal paskirtį 40513XXX: rankena – tai nemedicininės paskirties produktas, ji netinka žmonėms su kūno pažeidimais; naudojama tik asmeninėje erdvėje.
-  Fiksuoti reikia tik su rankena, kiti gaminiai šiam tikslui nepritaikyti.
-  Gaminių pritvirtinimo teisingumą ir patikimumą būtina periodiškai (kasmet) tikrinti.

## Montavimo instrukcija

Montuojant produktą, specialistas privalo įsitikinti, kad sienos plotas, prie kurio dedama montavimo plokštė, yra lygus (jokių plytelių ar kitų nelygumų), kad sienos struktūra yra pritaikyta produkto montavimui ir neturi jokių silpnų vietų. Pakuotėje esantys varžtai ir kaiščiai yra skirti tik betonui. Esant kitokiai sienai, varžtus ir kaiščius reikia rinktis pagal paskirtį.

## Simbolio aprašymas



Nenaudokite silikono, kurio sudėtyje yra acto rūgšties!

### **Išmatavimai** (žr. psl. 16-17)



Stiklinė gali būti įvairių dydžių



### **Atsarginės dalys** (žr. psl. 20)





XXX = Spalva  
000 = chrom  
820 = brushed nickel



### **Valymas** (žr. psl. 20) ir pridama brošiūra

Valymui nuimkite siurblij ir dangtį.

## Sigurnosne upute

-  Prilikom montaže se radi sprječavanja prignječenja i posjekotina moraju nositi rukavice.
-  Namjenska upotreba drška 40513XXX: Držak nije medicinski proizvod i nije prikladan za primjenu od strane tjelesno hendikepiranih osoba, već je namijenjen isključivo za upotrebu u privatnom okruženju.
-  Za držanje se smije koristiti isključivo držak, svi ostali proizvodi su za tu svrhu neprikladni.
-  U redovitim vremenskim razmacima (jednom godišnje) valja provjeravati propisnu pričvršćenost i stabilnost postavljenih proizvoda.

## Upute za montažu

Kada proizvod montira kvalificirano stručno osoblje treba paziti da čitava površina na koju se učvršćuje bude ravna (bez istaknutih fuga ili krivljenja pločica), da je zidna konstrukcija primjerena montaži proizvoda te osobito da nema slabih mjesta. Priloženi vijci i moždanici prikladni su samo za beton. Kod drugih zidnih nadgradnji treba obratiti pažnju na navode proizvođača moždanika.

## Opis simbola



Nemojte koristiti silikon koji sadrži octenu kiselinu!



### **Mjere** (pogledaj stranicu 16-17)

Stakleni dijelovi - različitosti dimenzija ne predstavljaju razlog za reklamaciju proizvoda.



### **Rezervni dijelovi** (pogledaj stranicu 20)

XXX = Boja  
000 = krom  
820 = brushed nickel



### **Čišćenje** (pogledaj stranicu 20) i priložena brošura

Kod punjenja i čišćenja crpke skinite poklopac





### ! Güvenlik uyarıları

- △ Montaj esnasında ezilme ve kesilme gibi yaralanmaları önlemek için eldiven kullanılmalıdır.
- △ Tutamak 40513XXX'in kullanım amacı: Tutamak tıbbi bir ürün olmadığından bedensel engelli kişiler için uygun olmayıp, sadece kişisel kullanım içindir
- △ Tutunmak için sadece tutamak kullanılabilir, diğer ürünler bu kullanıma uygun değildir.
- △ Monte edilmiş ürünlerin talimatlara uygun sabitliği ve sıkı duruşu düzenli aralıklarla (yıllık) kontrol edilmelidir.

### Montaj açıklamaları

Müteahhit, ürünü monteleyeceği yer, yani montaj plakasının monte edileceği duvar alanının tümü düz (herhangi bir eklem yerinin ya da duvar fayansının çıkıntısıyla) engellenmemiş, yapısı ürünü montelemeye uygun bir şekilde ve herhangi zayıf noktası olamamasını sağlamalıdır. Kaplı vidalar ve çubuklar sadece beton için uygundur. Başka duvar yapıları için, imalatçının çubuk imal edenin belirttiği hususlar dikkate alınmalıdır.

### Simge açıklaması



Asetik asit içeren silikon kullanmayın!



### Ölçüleri (Bakınız sayfa 16-17)

Ağza üfleme yapan parçalar -ölçü sapmaları- şikayet nedeni değildir



### Yedek Parçalar (Bakınız sayfa 20)

XXX = Renkler  
000 = krom  
820 = brushed nickel



**Temizleme** (Bakınız sayfa 20) ve birlikte verilen broşür

Doldurmak ve temizlemek için pompayı ve kapağı çıkartın.

### ! Instrucțiuni de siguranță

- △ La montare utilizați mânăși pentru evitarea contuziunilor și tăierii mâinilor.
- △ Utilizarea mânerului de sprijin 40513XXX conform destinației: Mânerul de sprijin nu este un produs medicinal, nefiind potrivit pentru persoanele cu dizabilități fizice, ci doar pentru a fi utilizat în domeniul privat
- △ Utilizați exclusiv mâner de sprijin pentru a vă sprijini, celelalte produse nu sunt potrivite pentru a fi utilizate cu acest scop.
- △ Fixarea corespunzătoare și poziția fixă a produselor montate trebuie verificate la intervale regulate (anual).

### Instrucțiuni de montare

La montarea produsului de către un personal calificat trebuie să fiți atenți ca suprafața, unde se fixează produsul să fie plată pe toată suprafața utilizată (să nu existe rosturi sau faianțe proeminente), peretele să fie adecvat pentru montarea produsului și să nu există zone de rezistență redusă. Șuruburile și diblurile livrate sunt potrivite pentru ziduri de beton. La alte tipuri de zid respectați instrucțiunile producătorului diblului utilizat.

### Descrierea simbolurilor



Nu utilizați silicon cu conținut de acid acetic!



### Dimensiuni (vezi pag. 16-17)

Piese fabricate manual - diferențele de dimensiuni nu pot considera motivul unei reclamații.



### Piese de schimb (vezi pag. 20)

XXX = cod de culori  
000 = crom  
820 = nichel mat



**Curățare** (vezi pag. 20) și broșura alăturată

Pentru umplere și curățare scoateți pompa și capacul.

**Montaj (Bakınız sayfa 18)**



**Montare (vezi pag. 18)**

**⚠ Υποδειξεις ασφαλείας**

- ⚠ Για να αποφύγετε τραυματισμούς κατά τη συναρμολόγηση πρέπει να φοράτε γάντια.
- ⚠ Ενδεδειγμένη χρήση της λαβής 40513XXX: Η λαβή δεν είναι ιατρικό προϊόν και δεν είναι κατάλληλη για άτομα με ειδικές ανάγκες, διότι έχει σχεδιαστεί μόνο για οικιακή χρήση.
- ⚠ Μπορεί να χρησιμοποιηθεί αποκλειστικά για κράτημα μόνο η λαβή. Τα υπόλοιπα προϊόντα είναι ακατάλληλα για τη χρήση αυτή.
- ⚠ Θα πρέπει να ελέγχετε ανά διαστήματα (ετησίως) αν η στερέωση εξακολουθεί να είναι επαρκής και αν τα τοποθετημένα προϊόντα σπηρίζονται καλά.

**Οδηγίες συναρμολόγησης**

Κατά τη συναρμολόγηση του προϊόντος από καταρτισμένο και εξειδικευμένο προσωπικό θα πρέπει να δοθεί προσοχή, ώστε η επιφάνεια στερέωσης στη συνολική περιοχή στερέωσης να είναι επίπεδη (να μην υπάρχουν προεξέχοντες αρμοί ή λιθογόμωση πλακιδίων), ώστε η κατασκευή του τοίχου να είναι κατάλληλη για τη συναρμολόγηση του προϊόντος και ώστε η επιφάνεια να μην παρουσιάζει αδύναμα σημεία. Οι συνημμένες βίδες και οι στυλίσκοι ενδείκνυνται μόνο για σκυρόδεμα. Σε άλλες επίπεχες κατασκευές θα πρέπει να δοθεί προσοχή στα δεδομένα του Κατασκευαστή των στυλίσκων.

**Περιγραφή συμβόλων**

Μην χρησιμοποιείτε σιλικόνη που περιέχει οξικό οξύ!

**Διαστάσεις** (βλ. σελίδα 16-17)

Τα τμήματα ελεύθερης σηματοδότησης και οι αποκλίσεις από τις διαστάσεις δεν δικαιολογούν τα όποια παράπονα.

**Ανταλλακτικά** (βλ. σελίδα 20)

XXX = Χρώματα  
000 = Επιχρωμωμένο  
820 = νικέλ ματ

**Καθαρισμός** (βλ. σελίδα 20) και συνημμένο φυλλάδιο

Για την πλήρωση και τον καθαρισμό της αντλίας, να αφαιρείτε το κάλυμμα.

**⚠ Varnostna opozorila**

- ⚠ Pri montaži je treba nositi rokavice, da se preprečijo poškodbe zaradi zmečkanja ali urezov.
- ⚠ Namenska uporaba držalnega ročaja 40513XXX: držalni ročaj ni medicinski proizvod, zato ni primeren za telesno prizadete osebe, temveč je namenjen le za privatno uporabo.
- ⚠ Za držanje se sme uporabljati izključno držalni ročaj, preostali proizvodi niso primerni za tovrstno uporabo.
- ⚠ V periodičnih presledkih (letno) je treba preverjati pravilno pritrditev in trdnost naseda montiranih proizvodov.

**Navodila za montažo**

Kamorkoli bo pogodbjenik namestil izdelek, mora poskrbeti, da je celotno območje stene na katero bo plošča nameščena ravno (brez štrlečih fug ali robov ploščic), ter da je struktura stene primerna za namestitev in je brez šibkih točk. Priloženi vijaki in ležaji so primerni le za beton. Za ostale zidne konstrukcije je potrebno poštevati proizvajalčeva navodila.

**Opis simbola**

Ne smete uporabiti silikona, ki vsebuje očetno kislino!

**Mere** (glejte stran 16-17)

Ustno pihani deli - odstopanja v velikosti niso razlog za reklamacijo.

**Rezervni deli** (glejte stran 20)

XXX = Barve  
000 = krom  
820 = brushed nickel





**Čiščenje** (glejte stran 20) in priložena brošura

Pri polnjenju in čiščenju snemite črpalko in pokrov.





## Ohutusjuhised

-  Kandke paigaldamisel muljumis- ja löikevigastuste vältimiseks kindaid.
-  Käepideme 40513XXX sihipärane kasutamine: käepide ei ole meditsiinitoode, see ei sobi füüsilise puudega inimestele, vaid on mõeldud erakasutuseks.
-  Käepidet võib kasutada ainult kinnihoidmiseks, ülejäänud tooted ei sobi selleks kasutusotstarbeks.
-  Monteeritud toote nõuetekohast paigaldust ja kinnitust tuleb korrapäraselt (kord aastas) kontrollida.

## Paigaldamisjuhised

Toote paigaldamisel peab töövõtja tagama, et kogu seinapind, kuhu paigaldusplaat kinnitatakse, on lame (ükski vuuk ega keraamiline plaat ei ulatu esile), ning et seina konstruktsioon on toote paigaldamiseks sobiv ja sellel puuduvad nõrgad kohad. Kaasasolevad kruvid ja tüüblid sobivad üksnes betoonile. Muude seinakonstruktsioonide puhul tuleb arvesse võtta tüüblitootja esitatud tooteandmeid.

## Sümbolite kirjeldus



Ärge kasutage äädikhapet sisaldavat silikooni!



### Mõõtude (vt lk 16-17)

Klaas võib olla erimõõduline, kuna see on suuga puhutud. Kaebus pole õigustatud.



### Varuosad (vt lk 20)





XXX = Värvikood  
000 = kroom  
820 = brushed nickel



### Puhastamine (vt lk 20) ja kaasasolev brošüür

Eemaldage täitmis ja puhastus pumba kate täitmiseks ja puhastamiseks.

## Drošības norādes

-  Montāžas laikā, lai izvairītos no saspiedumiem un iegriezumiem, nepieciešams nēsāt cimdus.
-  Roktura 40513XXX pareiza lietošana: rokturis nav medicīniskais produkts, tas ir piemērots nevis personām ar īpašām fiziskām vajadzībām, bet gan tikai privātai lietošanai.
-  Turēšanai drīkst izmantot vienīgi rokturi, pārējie produkti nav piemēroti šim nolūkam.
-  Nepieciešams periodiski (reizi gadā) pārbaudīt, vai uzmontētie produkti ir pareizi piestiprināti un labi turas.

## Norādījumi montāžai

Ja izstrādājuma montāžu veic kvalificēti speciālisti, jāseko, lai nostiprināšanas virsma visā nostiprināšanas zonā būtu gluda (šuves un flīzes nav izvirzītas uz āru), lai sienas konstrukcija būtu piemērota izstrādājuma montāžai un būtu pietiekami izturīga. Komplektā esošās skrūves un dībeļi ir paredzēti tikai šī izstrādājuma nostiprināšanai. Ja sienas konstrukcija ir citāda, jāievēro dībeļu ražotāja norādījumi.

## Simbolu nozīme



Neizmantojiet silikonu, kas satur etiķskābi!



### Izmērus (skat. 16-17. lpp.)

Izpūstas stikla daļas - izmēru atšķirības nevar būt reklamācijas iemesls.



### Rezerves daļas (skat. 20. lpp.)

XXX = Krāsas  
000 = hroma  
820 = brushed nickel



### Tīrīšana (skat. 20. lpp.) un klāt pievienotais buklets

Lai piepildītu un iztīrītu, noņemiet sūkni un vāciņu.

## Paigaldamine (vt lk Montāža (skat. 18. lpp.)



## ! Sigurnosne napomene

- ⚠ Prilikom montaže se radi sprečavanja prignječena i posekotina moraju nositi rukavice.
- ⚠ Namenska upotreba drške 40513XXX: Drška nije medicinski proizvod i nije podesna za korišćenje od strane telesno hendikepiranih osoba, već je namenjena isključivo za upotrebu u privatnom okruženju.
- ⚠ Za držanje sme da se koristi isključivo drška, svi ostali proizvodi su za tu svrhu nepodesni.
- ⚠ Propisna pričvršćenost i stabilnost postavljenih proizvoda treba redovno da se proverava (jednom godišnje).

## Instrukcije za montažu

Kada proizvod montira kvalifikovano stručno osoblje treba paziti da čitava površina na koju se učvršćuje bude ravna (bez istaknutih fuga ili krivljenja pločica), da je zidna konstrukcija primerena montaži proizvoda, i posebno da nema slabih mesta. Priloženi zavrtnji i tiplovi prikladni su samo za beton. Kod drugih zidnih nadgradnji treba obratiti pažnju na navode proizvođača tiplova.

## Opis simbola



Nemojte koristiti silikon koji sadrži sirćetnu kiselinu!



**Mere** (vidi stranu 16-17)

Ručno napravljeni stakleni delovi - odstupanje dimenzija ne predstavlja razlog za reklamaciju proizvoda.



**Rezervni delovi** (vidi stranu 20)

XXX = Oznake boja  
000 = hrom  
820 = brushed nickel



**Čišćenje** (vidi stranu 20) i priložena brošura

Kod punjenja i čišćenja pumpe skinite poklopac.

## ! Sikkerhetshenvisninger

- ⚠ Bruk hansker under montasjen for å unngå klem- og kuttskader.
- ⚠ Bestemmelsemessig bruk av håndtak 40513XXX: Håndtaket er ikke et medisinsk produkt som egner seg for personer med handicap. Det er kun bestemt for privat bruk.
- ⚠ For å holde seg fast skal kun håndtaket brukes. De øvrige produktene er ikke egnet for dette bruk.
- ⚠ De monterte produktene skal regelmessig sjekkes om de er ordentlig festet og om de sitter fast.

## Montagehenvisninger

Når kvalifisert fagfolk monterer produktet, skal man påse at hele området der produktet monteres er plant (ingen fremstående fuger eller flisekanter), at oppbygging av veggene er egnet for montasje av produktet og at veggene ikke viser noen svakpunkter. Medleverte skruer og plugg er egnet seg kun for betong. Ved en annen veggoppbygging skal man ta hensyn til pluggprodusentens henvisninger.

## Symbolbeskrivelse



Ikke bruk silikon som inneholder eddiksyre!



**Mål** (se side 16-17)

Munnblåste deler - Måldifferanser gir ingen rett til reklamasjon



**Service deler** (se side 20)

XXX = Oznake boja  
000 = hrom  
820 = brushed nickel







**Rengjøring** (se side 20) og vedlagt brosjyre

Ta av deksel og pumpe for fylling og rengjøring.







## Указания за безопасност

-  При монтажа трябва да се носят ръкавици, за да се избегнат наранявания поради притискане или порязване.
-  Използване по предназначение на дръжката 40513XXX: Дръжката не е медицински продукт, тя не е предназначена за използване от лица с физически недостатъци, а само в частната сфера.
-  За хващане да се използва само дръжката, останалите продукти не са подходящи за тази цел.
-  Правилното закрепване и правилното разположение на монтираните продукти трябва да се проверява периодично (ежегодно).

## Указания за монтаж

При монтаж на продукта от квалифицирани специалисти да се внимава за това, закрепващата повърхност в целия диапазон на закрепването да бъде равна (без изпъкнали фути или изместване на плочки), конструкцията на стената да е подходяща за монтаж на продукта и особено за това, да няма слаби места. Приложените винтове и дюбели са подходящи само за бетон. При други стенни конструкции да се спазват данните на производителя на дюбели.





## Описание на символите

-  Не използвайте силикон, съдържащ оцетна киселина!
-  **Размери** (вижте стр. 16-17)  
Ръчно духани части – Отклоненията от размерите не могат да бъдат повод за рекламация.
-  **Сервизни части** (вижте стр. 20)  
XXX = Oznake boja  
000 = hrom  
820 = brushed nickel

-  **Почистване** (вижте стр. 20) и приложена брошура  
За пълнене и почистване свалете помпата и капака.

**Монтаж (вижте стр. 18)**



## Udhëzime sigurie

-  Për të evituar lëndimet e pickimeve ose të prerjeve gjatë procesit të montimit duhet që të vishni doreza.
-  Përdorimi i rregullt i dorezës 40513XXX: Doreza nuk është produkt mjekësor. Ajo nuk është paraparë për persona me kufizime fizike por vetëm për sferën private.
-  Vetëm doreza mund të përdoret për t'u mbajtur. Të gjitha produktet e tjera nuk janë të përshtatshme për këtë qëllim.
-  Montimi dhe pozicioni sipas rregullave i produkteve të montuara duhet verifikuar periodikisht (një herë në vit).

## Udhëzime për montimin

Gjatë montimit të produktit nga ana e personit të kualifikuar duhet pasur parasysh që e gjithë sipërfaqja mbërthyesë të jetë e drejtë (nuk duhet të ketë hapësira mes pllakave). Mbi të gjitha muri duhet të jetë i përshtatshëm për montim dhe nuk duhet të ketë pika të dobëta. Vidhat dhe kunjat e bashkangjitura janë të përshtatshme vetëm për beton. Te përbërja tjetër murore të merren parasysh të dhënat e prodhuesit të kunjave.

## Përshkrimi i simbolit

-  Mos përdorni silikon që në përbërje ka acid acetik.
-  **Përmasat** (shih faqen 16-17)  
Pjesë të fryra me gojë - devijime nga përmasat nuk ju japin të drejtën të bëni reklamacion
-  **Pjesët e servisit** (shih faqen 20)  
XXX = Oznake boja  
000 = hrom  
820 = brushed nickel

-  **Pastrimi** (shih faqen 20) dhe broshura bashkëngjitur  
Për mbushje dhe pastrim të hiqen pompa dhe kapaku.

 **Montimi (shih faqen 18)**



### تنبيهات الأمان



يجب إرتداء قفازات لليد أثناء التركيب لتجنب حدوث أخطار الإنحسار أو الجروح.



الاستخدام المطابق للشروط للمقبض 40513XXX: لا يعتبر هذا المقبض منتجاً طبيياً، كما أنه غير ملائم للأشخاص المصابين بإعاقات بدنية وإنما هو مخصص للاستخدام الشخصي فحسب.



يحظر استخدام المقبض إلا من أجل التثبيت فحسب. وبالنسبة لبقية المنتجات الأخرى، فهي غير صالحة لهذا الغرض من الاستخدام.



يتعين التأكد من أن حالة التثبيت مطابقة للشروط المحددة والتأكد من الوضع الثابت للمنتجات المركبة على قفازات منتظمة (سنويًا).



### تعليمات التركيب

يجب الانتباه عند تركيب المنتج بواسطة فريق العمل المتخصص إلى أن جميع مواضع التثبيت جاهزة للتثبيت دون عوائق (خالية من المفصلات أو الملمصقات)، وأن الحائط جاهز لتركيب المنتج مع عدم احتوائه على أية أماكن ضعيفة. مبيئات المسامير (الفيشر) والمسامير نفسها مناسبة للحوائط الخرسانية فقط، ويجب الالتزام بتعليمات الجهة المصنعة لمبيئات المسامير عند التثبيت في أنواع أخرى من الحوائط.

### وصف الرمز

هام! لا تستخدم السليكون الذي يحتوي على أحماض!



أبعاد (راجع صفحة 16-17)



قد يسبب البخار المتراكم على القطع تغييراً في الأبعاد الحقيقية، ولذلك فإنه لا يلزم المطالبة بتوصليحات.

قطع الغيار (راجع صفحة 20)



الألوان = XXX

كروم = 000

نيكل مفرّش = 820

التنظيف (راجع صفحة 20) والكتيب المرفق

ارفع المضخة والغطاء للماء والتنظيف.



### Logis 40523XXX

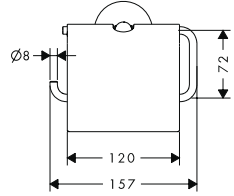
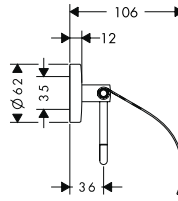

### Logis 40526XXX

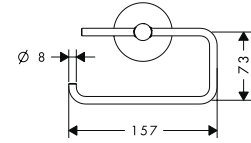
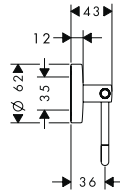

### Logis 40517XXX

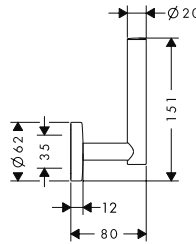

### Logis 40522XXX

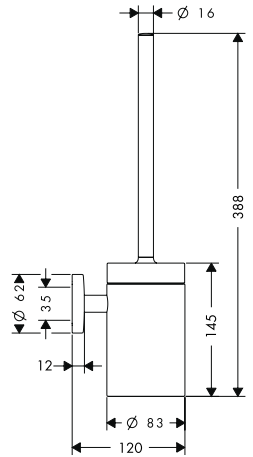

### Logis 40518XXX

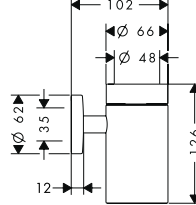





**Logis 40512XXX**

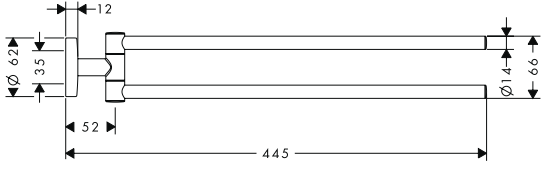

**Logis 40514XXX**

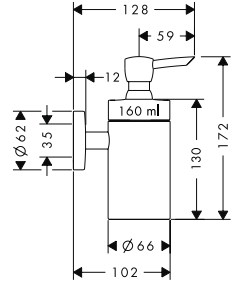

**Logis 40515XXX**

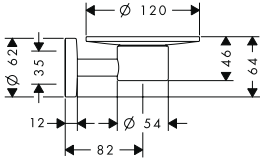

**Logis 40511XXX**

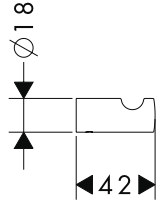

**Logis 40513XXX**

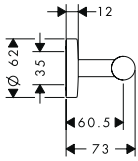

**Logis 40513XXX**

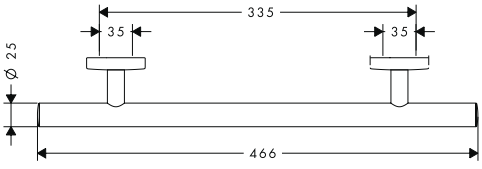

**Logis 40516XXX**

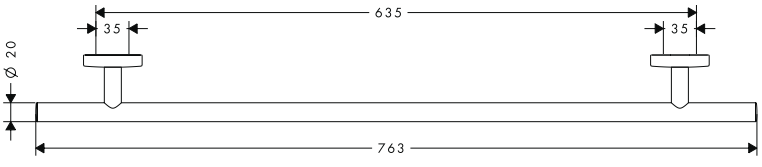
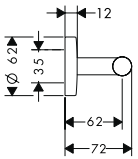



40512XXX/40514XXX/40515XXX/40517XXX/40518XXX/40522XXX/40523XXX/40526XXX

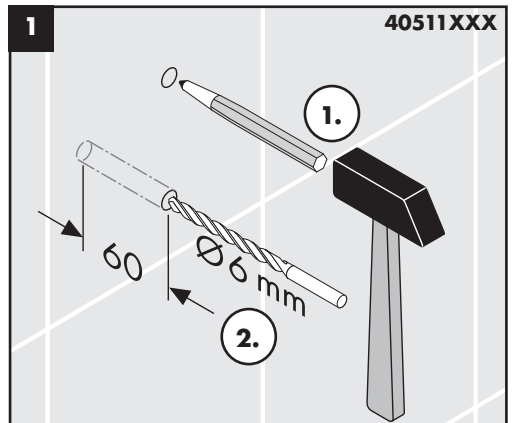
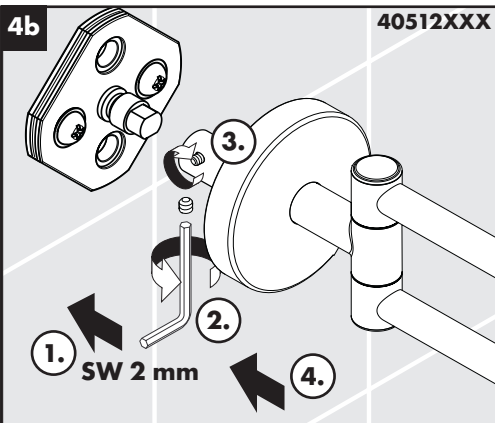
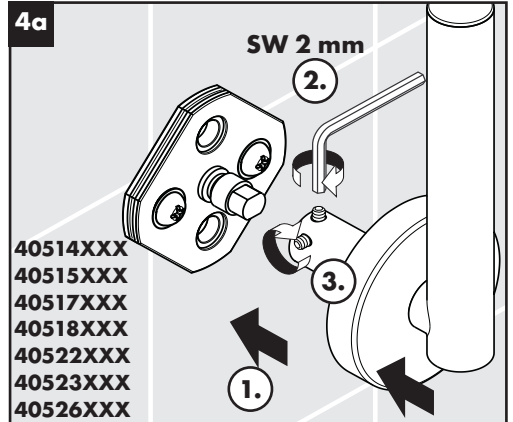
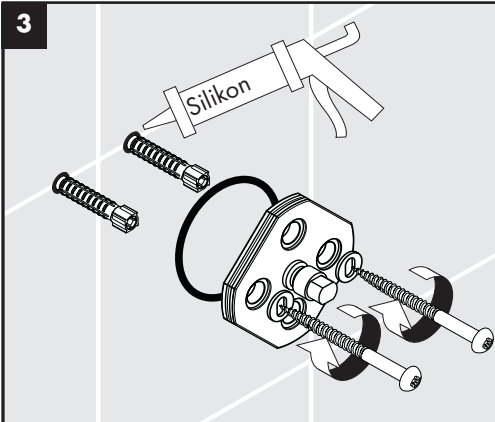
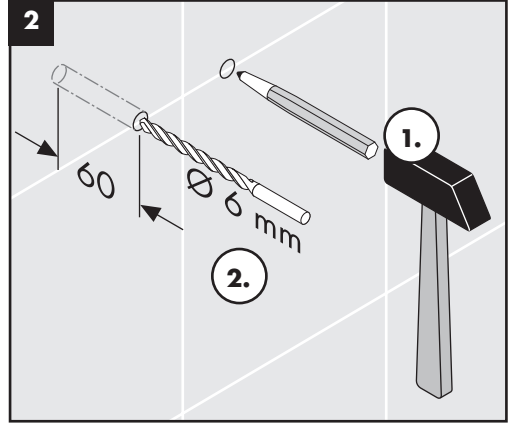
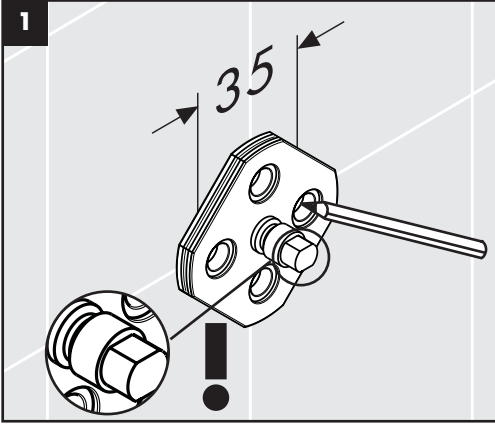

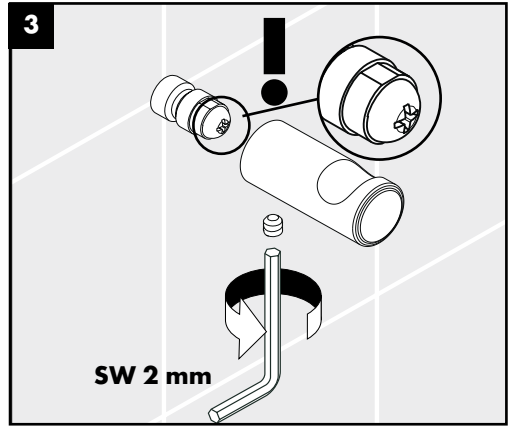
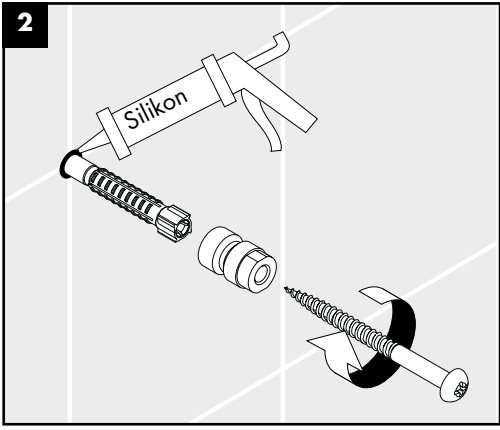

Logis 40513XXX/40516XXX

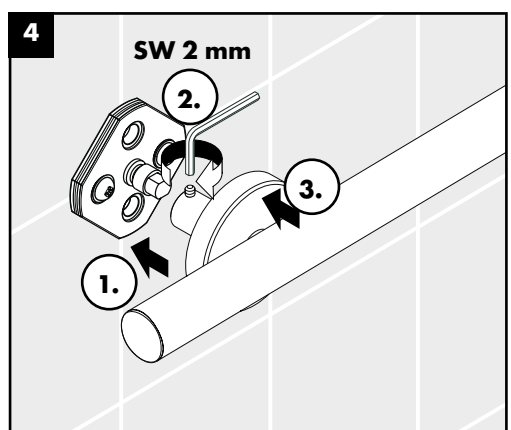
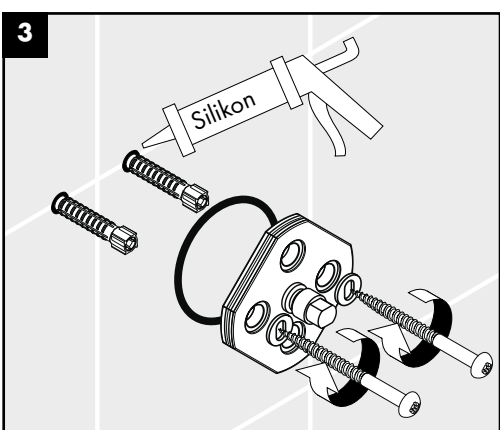
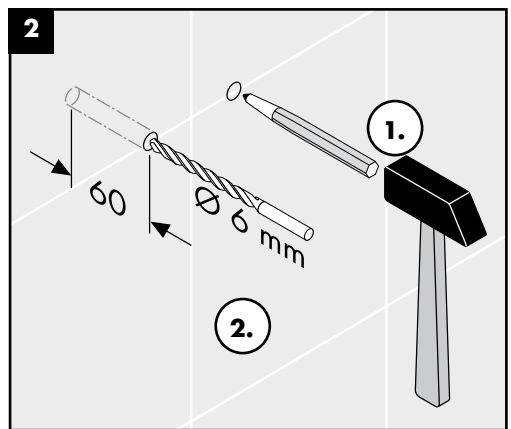
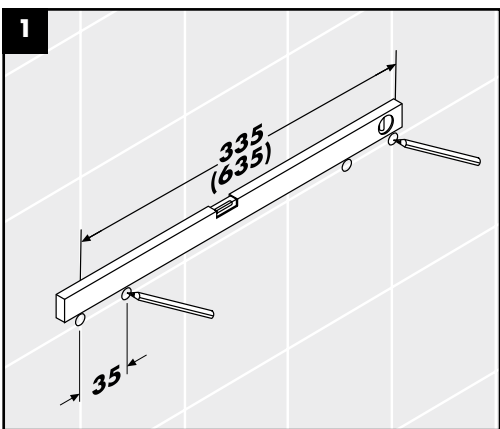

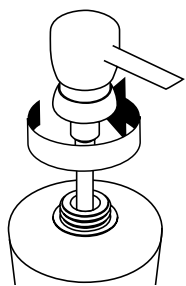
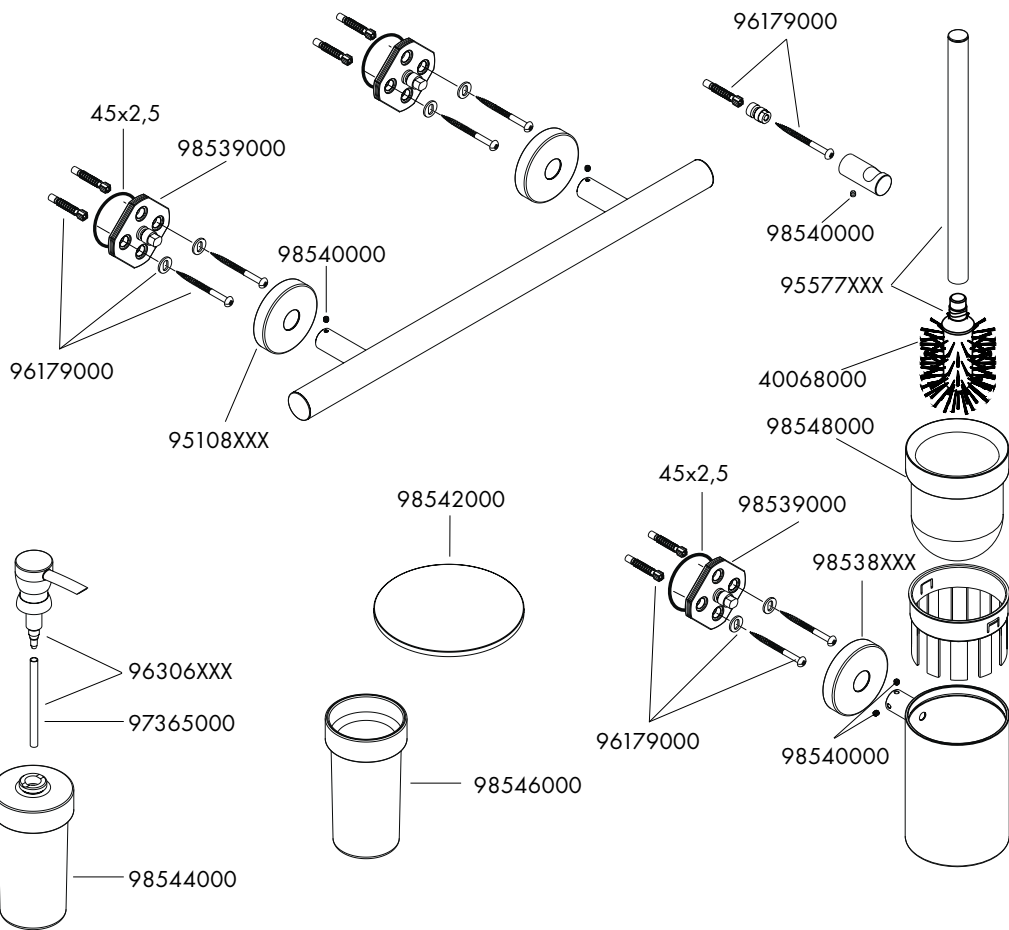

**hansgrohe**