

KETER[®]

BISTRO

Assembly Instructions | Instructions de Montage |
Montageanleitung | Instrucciones de Montaje | Istruzioni di
montaggio | Montagevoorschrift | Instruções de montagem



WWW.KETER.COM



Notes and Warnings - Please Read Carefully Prior to Assembly
Notes et avertissements - Veuillez lire attentivement avant l'assemblage
Anmerkungen und Warnhinweise - Bitte sorgfältig vor der Montage lesen
Opmerkingen en waarschuwingen - Voor het monteren aandachtig doorlezen
Notas y advertencias: lea con atención antes de montar
Osservazioni e avvertimenti - Leggere attentamente prima dell'assemblaggio
Notas e Avisos - Leia cuidadosamente antes da montagem

- Ⓔ**N** • Please assemble each piece of furniture on a flat surface.
 - The pieces of furniture should only be cleaned using soap, water, and a soft cloth.
 - The pieces of furniture are only intended for reasonable use

- Ⓔ**R** • Veuillez assembler chaque meuble sur une surface plane.
 - Les meubles doivent être nettoyés au savon et à l'eau uniquement, et à l'aide d'un chiffon doux.
 - Les meubles sont destinés à un usage raisonnable.

- Ⓔ**D** • Bitte montieren Sie jedes Möbelstück auf einer glatten Fläche.
 - Zur Reinigung der Möbelstücke sind nur Seifenlauge, Wasser und ein weiches Tuch zu verwenden.
 - Die Möbelstücke sind nur für eine angemessene Nutzung vorgesehen











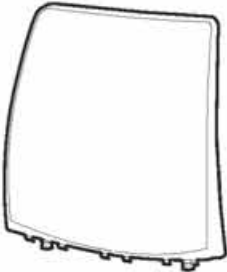



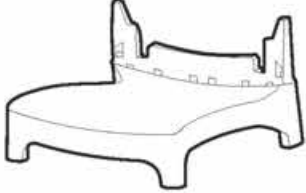







- Ⓔ**NL** • Monteer elke meubelstuk op een vlakke ondergrond.
 - De meubels mogen alleen met zeep, water en een zachte doek worden gereinigd.
 - De meubelstukken zijn alleen bedoeld voor redelijk gebruik.

- Ⓔ**ES** • Monte el mueble sobre una superficie plana.
 - Los muebles sólo deben limpiarse utilizando jabón, agua, y un trapo suave.
 - Las piezas del mobiliario solo están pensadas para un uso razonable.

- Ⓔ**IT** • Assemblare ogni componente su una superficie piana.
 - Per la pulizia dei componenti del set, utilizzare solo sapone, acqua e un panno pulito.
 - I mobili sono destinati esclusivamente ad un uso appropriato.

- Ⓔ**PT** • Monte cada peça da mobília numa superfície plana.
 - As peças da mobília devem ser limpas apenas com sabão, água e um pano macio.
 - As peças da mobília destinam-se apenas a um uso razoável.

ASSEMBLY PARTS | PIÈCES À ASSEMBLER | MONTAGETEILE | PIEZAS DE ENSAMBLE
MONTAGESTUKKEN | PARTI DA MONTARE | PEÇAS DE MONTAGEM

 BL X2	 LN X2	 FLP X2	 BLP X2	 K X2
 CS X2	 RN X2	 FRB X2	 BRP X2	 X5
 TB X1	 LFLX2	 RFL X2	 LBL X2	 RBL X2
 TL X4	 TC X1	 BC X1	 PS X2	 PL X2
 TL X4	 S X2	 NP X1		

X2



1	 CS X1	 LFL X1	 RFL X1	 LBL X1	 RBL X1
	 FLP X2	 FRB X2	 BLP X2	 BRP X2	

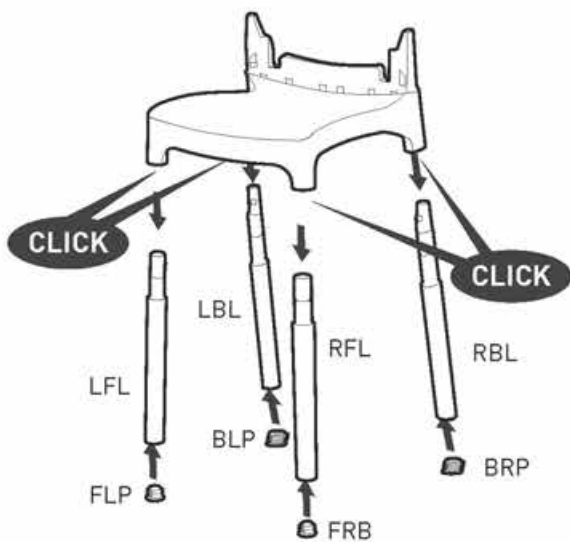

2



BL X1

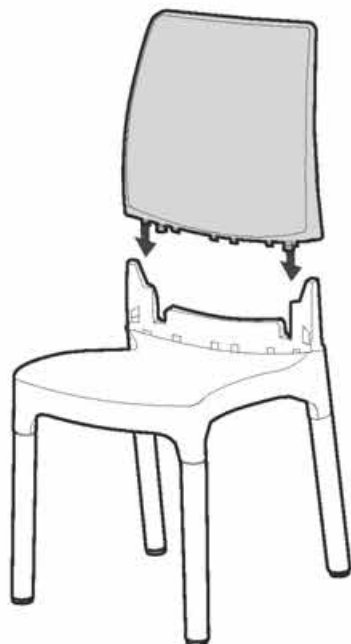

3



RN X1



LN X1



X4



K X1

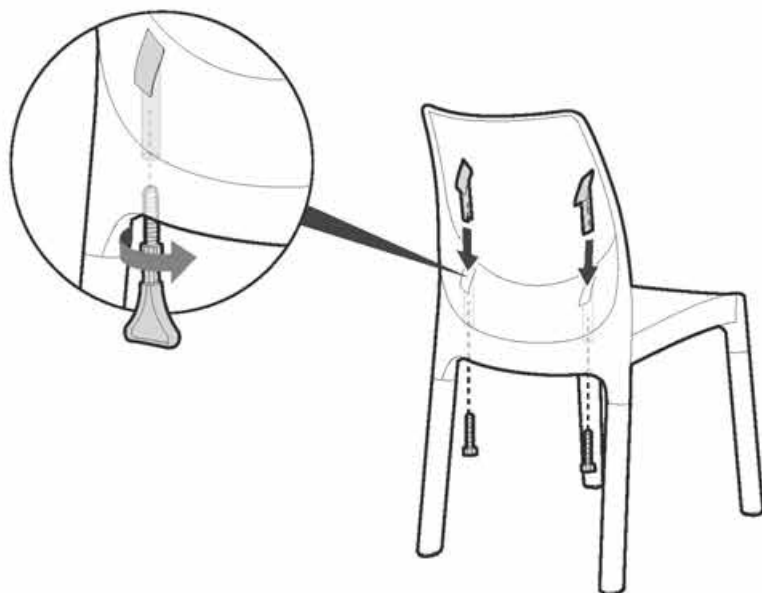

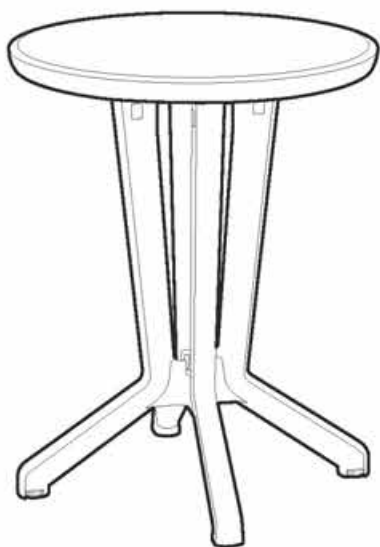

1



TL X4



PS X2



PL X2



S X2

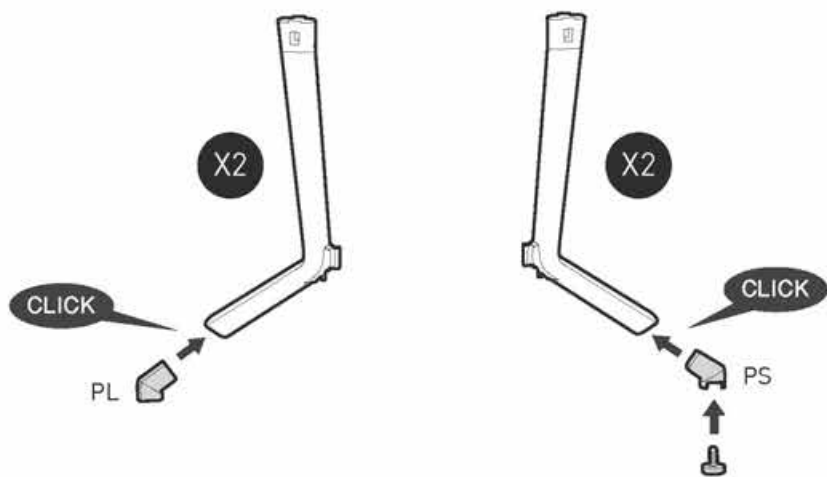

2



TC X1



NP X1

1

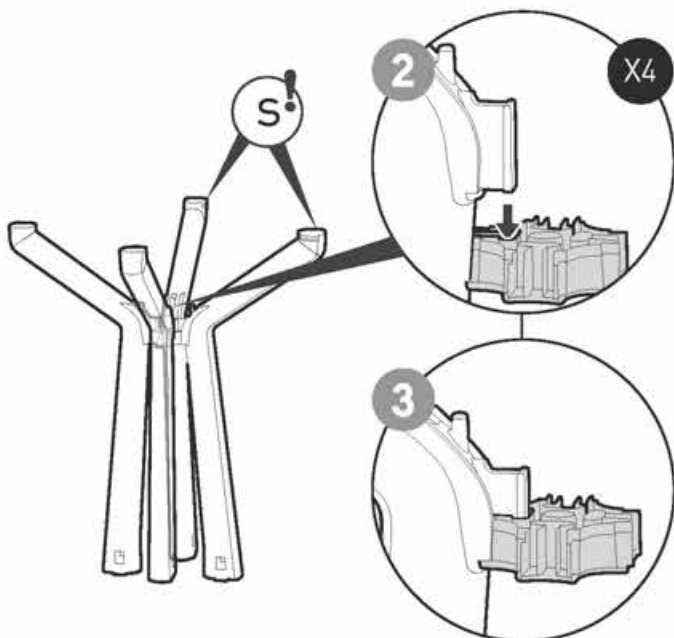
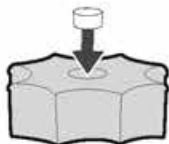

3



BC X1



K X1

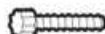

X1

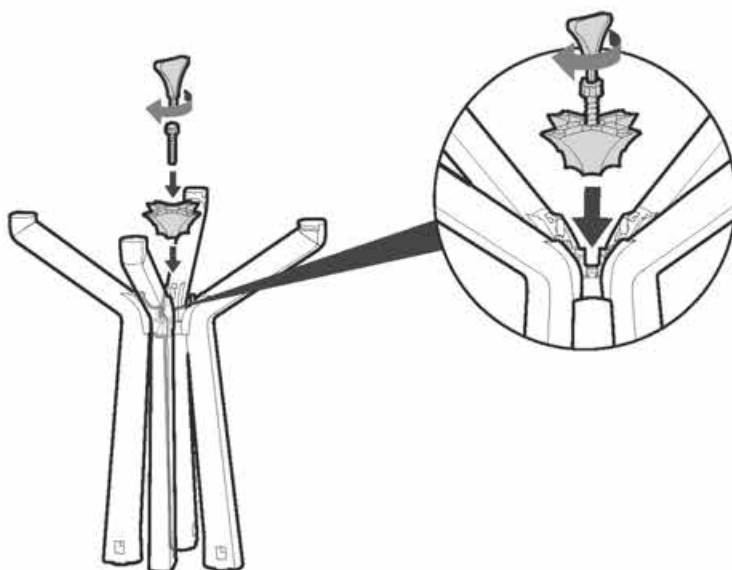

2



TB X1

