

GARDEN HOUSE

EN DE CZ SK HU PL

PAH 357 - 188 x 190 cm, PLASTIC

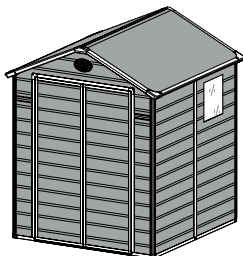

۱۲۱



Thank you for purchasing our product.

Before using this unit, please read this manual.

Assembly instructions:

Prior to the assembly please read all instructions and information carefully.

Check whether you have all parts which are necessary for the assembly.

The plastic shed has to be anchored to its base in order to prevent damage. The base is not included in the delivery and it has to be built separately.

Please mind your own safety.

1. Assemble the shed in dry, calm conditions. Do not assemble in windy conditions.
2. 2-3 persons are required for the assembly of this plastic shed.
3. Use protective clothing, gloves and goggles when assembling the shed.
4. During the assembly no children or pets should be presented in the working area.

Care and maintenance:

1. Keep the doors closed and locked when the shed is not in use to prevent wind damage.
2. Clean the house using cloth and water.
3. Always remove fallen leaves from the roof as soon as possible to prevent them staining the roof. In case of snowfall remove the snow from the roof regularly. Large amounts of snow on the roof can damage the shed.
4. The house is not designed for living but only for storage purposes. Do not store hot items, such as recently used grills, blowtorches and volatile chemicals in the shed.

The English version of the manual is an exact translation of the original manufacturer's instructions. Images used in this manual are for illustrational purposes only and may differ from the actual product.



Vielen Dank für den Kauf unseres Produktes.

Bevor Sie dieses Gerät verwenden, lesen Sie diese Anleitung.

Montageanleitung:

Bevor Sie mit der Montage beginnen, lesen Sie sorgfältig alle Anweisungen und Informationen durch.

Überprüfen Sie, ob Ihnen alle notwendigen Teile für den Bau des Gartenhauses zur Verfügung stehen.

Das Gartenhaus muss ordnungsgemäß an der Grundplatte verankert werden, damit es bei starkem Wind nicht zur dessen Beschädigung oder Zerstörung kommt. Die Grundplatte ist nicht im Lieferumfang enthalten, diese muss getrennt gebaut werden.

Achten Sie auf Ihre Sicherheit.

1. Die Montage des Hauses ist an einem trockenen Ort und bei guten Wetterbedingungen durchzuführen.
2. Montieren Sie das Haus in 2-3 Personen.
3. Tragen Sie bei der Montage Schutzkleidung, Handschuhe und Schutzbrille.
4. Während der Montage sollten sich auf der Baustelle keine Kinder und Haustiere bewegen.

Pflege und Wartung:

1. Halten Sie die Tür geschlossen und verriegelt, um Beschädigungen durch Wind zu vermeiden.
2. Reinigen Sie das Haus mit einem Tuch und Wasser.
3. Entfernen Sie Laubblätter immer möglichst schnell, um Verfärbungen des Dachs zu vermeiden. Entfernen Sie den gefallenen Schnee regelmäßig vom Dach. Größere Schneemengen auf dem Dach können Schäden am Dach verursachen.
4. Das Haus ist nicht zum Wohnen, sondern zum Aufbewahren von Sachen vorgesehen. Im Gartenhaus dürfen keine heißen Gegenstände wie heiße Grills, UV-Lampen, flüchtige Chemikalien usw. gelagert werden.

Die deutsche Version der Anleitung ist eine genaue Übersetzung der Anleitung des Herstellers. Die in diesem Handbuch verwendeten Bilder dienen nur zur Illustration und können nicht genau das Produkt entsprechen.



Děkujeme za nákup našeho výrobku.

Před použitím si prosím přečtete tento návod.

Montážní návod:

Dříve, než začnete s montáží, pečlivě si prostudujte všechny pokyny a informace.

Zkontrolujte, zda máte všechny potřebné díly pro stavbu domku.

Domek musí být řádně ukotven k základové desce, aby nedošlo při silném větru k jeho poškození nebo zničení. Základová deska není součástí balení, je nutné si ji vybudovat samostatně.

Dbejte na svoji bezpečnost.

1. Montáž domku provádějte na suchém místě a za dobrých povětrnostních podmínek.
2. Domek montujte ve 2-3 lidech.
3. Při montáži používejte ochranný oděv, rukavice a ochranné brýle.
4. V době montáže by se po staveništi neměly pohybovat děti a domácí zvířata.

Péče a údržba:

1. Dveře od domku nechávejte zavřené a zamčené, aby nedošlo k poškození vlivem větru.
2. Domek čistěte za pomoci hadru a vody.
3. Vždy odstraňte spadané listí ze střechy co nejdříve, aby nedošlo k zbarvení střechy. Ze střechy pravidelně odstraňujte napadaný sníh. Větší nános sněhu na střeše může způsobit poškození střechy.
4. Domek není určen pro bydlení, ale pro ukládání věcí. V zahradním domku neskladujte horké předměty, jako např. rozpálený gril, opalovací lampy, těkavé chemikálie apod.

Česká verze návodu je přesným překladem originálního návodu výrobce.

Fotografie použité v manuálu jsou pouze ilustrační a nemusí se přesně shodovat s výrobkem.



Ďakujeme za nákup nášho výrobku.

Pred použitím si prosím prečítajte tento návod.

Montážny návod:

Skôr, než začnete s montážou, starostlivo si preštudujte všetky pokyny a informácie.

Skontrolujte, či máte všetky potrebné diely pre stavbu domčeka.

Domček musí byť riadne ukotvený k základnej doske, aby nedošlo pri silnom vetre k jeho poškodeniu alebo zničeniu. Základná doska nie je súčasťou balenia, je nutné si ju vybudovať samostatne.

Dbajte na svoju bezpečnosť.

1. Montáž domčeka vykonávajte na suchom mieste a za dobrých poveternostných podmienok
2. Domček montujte v 2-3 ľuďoch.
3. Pri montáži používajte ochranný odev, rukavice a ochranné okuliare.
4. V čase montáže by sa po stavenisku nemali pohybovať deti a domáce zvieratá.

Starostlivosť a údržba:

1. Dvere od domčeka nechávajú zatvorené a zamknuté, aby nedošlo k poškodeniu vplyvom vetra.
2. Domček čistite s pomocou handry a vody.
3. Vždy odstráňte opadané listy zo strechy čo najskôr, aby nedošlo k sfarbeniu strechy. Zo strechy pravidelne odstraňujte napadaný sneh. Väčšia nános snehu na streche môže spôsobiť poškodenie strechy.
4. Domček nie je určený pre bývanie, ale pre ukladanie vecí. V záhradnom domčeku neskladujte horúce predmety, ako napr. Rozpálený gril, opaľovacie lampy, prchavé chemikálie a pod.

Slovenská verzia návodu je presným prekladom originálneho návodu výrobcu.

Fotografie použité v návode sú len ilustračné a nemusia sa presne zhodovať s výrobkom.



Köszönjük, hogy megvásárolta termékünket.

Használat előtt kérjük olvassa el a használati útmutatót.

Összeszerelési útmutató

Az összeszerelés megkezdése előtt alaposan olvassa el az összes utasítást és információt.

Győződjön meg róla, hogy rendelkezésére áll minden szükséges alkatrész a kerti ház összeszereléséhez.

A házat megfelelően rögzíteni kell az alapszerkezethez, hogy ne károsíthassa meg az erős szél. Az alapszerkezetet a csomagolás nem tartalmazza, külön kell biztosítani.

Vigyázzon a biztonságára.

1. A kerti házat száraz helyen és jó időjárási körülmények között szerelje össze.
2. A ház összeszereléséhez 2-3 emberre szükség van.
3. Az összeszerelés során használjon védőruházatot, kesztyűt és szemvédőt.
4. Az összeszereléskor gyermekek és háziállatok nem tartózkodhatnak a helyszínen.

Kezelés és karbantartás

1. A kerti ház ajtaját tartsa zárva, hogy elkerülje a szél okozta károkat.
2. A ház tisztításához használjon rongyot és vizet.
3. Mindig söpörje le a tetőről a ráhullott leveleket a lehető leghamarabb, hogy elkerülje a tető elszíneződését. Távolítsa el a ráhulló havat rendszeresen. A tetőre hullott nagyobb hó károsíthatja a kerti házat.
4. A ház nem alkalmas lakásnak, csak kellékek tárolására. Ne tároljon benne forró tárgyakat, mint pl. forró grill, napozó lámpa, illékony, vagy vagyí anyagokat stb.

A magyar használati utasítás a gyártótól kapott verzió pontos fordítása.

A kézikönyvben használt fényképek csak illusztrációk, nem egyeznek meg pontosan a termékkel.



Dziękujemy za zakup naszego produktu.

Przed użyciem prosimy starannie przeczytać tę instrukcję.

Instrukcja montażu:

Przed przystąpieniem do montażu należy dokładnie zapoznać się z wszystkimi zaleceniami i informacjami.

Sprawdź, czy posiadasz wszystkie niezbędne elementy do zbudowania altany ogrodowej.

Altana musi być prawidłowo zakotwiona do płyty fundamentowej, aby przy mocno wiejącym wietrze nie doszło do jej uszkodzenia lub zniszczenia. Płyta fundamentowa nie jest elementem zestawu, należy ją wykonać we własnym zakresie.

Dbaj o swoje bezpieczeństwo.

1. Montaż altany ogrodowej przeprowadzić w miejscu suchym i przy sprzyjających warunkach pogodowych.
2. Montaż altany ogrodowej przeprowadzać przy udziale 2-3 osób.
3. Przy montażu należy użyć odzieży ochronnej, rękawic i okularów ochronnych.
4. Podczas trwania montażu na placu budowy nie powinny przebywać dzieci i zwierzęta domowe.

Pielęgnacja i konserwacja:

1. Drzwi altany ogrodowej pozostawiać w stanie zamkniętym i zabezpieczonym zamkniętym zamkiem, aby uniknąć uszkodzeń spowodowanych na skutek działania wiatru.

2. Altanę ogrodową czyścić używając ścierek i wody.

3. Zawsze, jak najprędzej, należy usuwać opadłe liście z dachu, aby nie powodowały wystąpienia przebarwień na dachu. Z dachu należy regularnie usuwać śnieg. Grubsza warstwa okrywy śniegowej może spowodować uszkodzenie dachu.

4. Altana ogrodowa nie jest przeznaczona do zamieszkania, służy do przechowywania rzeczy. W altanie ogrodowej nie składować przedmiotów gorących, jak np. rozpalony grill, lampy do opalania, lotne chemikalia, itp.

Polska wersja językowa instrukcji jest dokładnym tłumaczeniem oryginalnej instrukcji producenta. Zdjęcia wykorzystane w tym podręczniku są jedynie ilustracją i nie może dokładnie dopasować produkt.

Installation

Montage

Montáž

Gyülekezés

Montaż









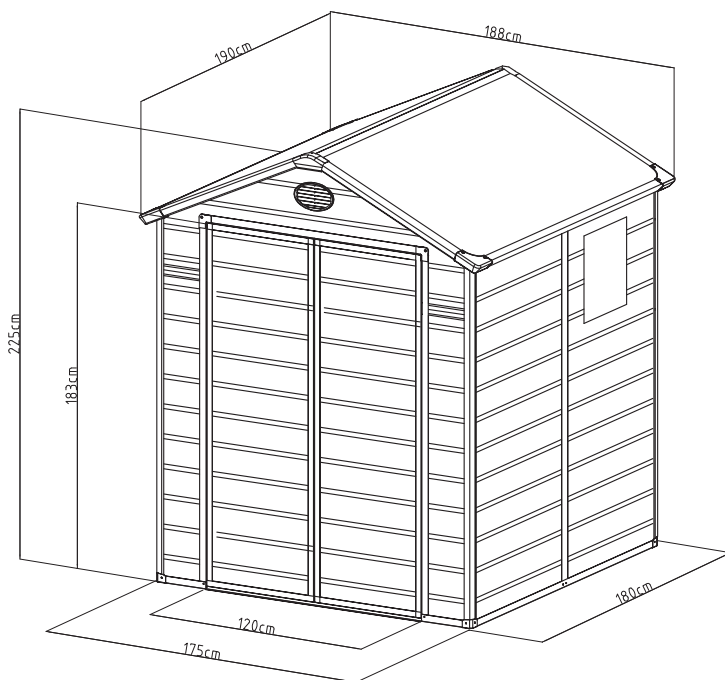















Tools you will need / Werkzeuge, die Sie brauchen / Nástroje, které budete potřebovat
Nástroje, ktoré budete potrebovať / Eszközök, amelyekre lesz szüksége / Przyrządy i narzędzia, które będą potrzebne

























Dimensions \ Abmessungen \ Rozměry \ Rozmery \ Méretek \ Wymiary



Parts list \ Teilleiste \ Seznam dílů \ Zoznam dielov \ Alkatrész lista \ Wykaz części

| | | | |
|---|--------|----------|----|
|  | VA-C1 | 1734.5 | x1 |
| | VA-B2 | 1780 | x2 |
| | VA-C3R | 267 | x1 |
| | VA-C3L | 267 | x1 |
|  | VA-C4 | 1278 | x1 |
|  | VA-30 | | x4 |
|  | VA-31 | | x4 |
|  | VA-37 | | x4 |
| | | | |
|  | PB1 | 876X1840 | x3 |
|  | PB1W | 876X1840 | x1 |
|  | PB2 | 1710X677 | x1 |
|  | PB3L | 566X990 | x1 |
|  | PB3R | 566X990 | x1 |
|  | PB3M | 566X1125 | x1 |
|  | PB4 | 566X1100 | x3 |
|  | PB5 | 255X1548 | x2 |
|  | VA-C7R | 1860 | x2 |
| | VA-C7L | 1860 | x2 |
|  | VA-C5 | 1840 | x2 |
| | VA-C6 | 2100 | x2 |
|  | W1 | | x1 |
|  | W2 | | x1 |
|  | PPX10 | | x1 |
|  | VA-C8 | 562 | x3 |
| | VA-C9 | 250 | x2 |
|  | VA-C11 | 562 | x3 |
| | VA-C12 | 250 | x2 |
|  | VA-D17 | 1797 | x2 |
|  | VA-D19 | 888 | x2 |
| | VA-D20 | 725 | x1 |
| | VA-33 | | x2 |
| | VA-34 | | x1 |
| | VA-D23 | 1797 | x1 |
| | VA-B24 | 1900 | x1 |
| | VA-36 | | x2 |
| | VA-32R | | x2 |
| | VA-32L | | x2 |
| | | | |
| | PB6-B | 990X1865 | x2 |
| | VA-D21 | 860 | x4 |
| | VA-B22 | 1705 | x2 |
| | PB7 | 591X1810 | x2 |

| | | | |
|---|---------|------|------|
|  | VA-C25R | 1830 | x1 |
| | VA-C25L | 1830 | x1 |
| | VA-C26 | 1198 | x1 |
| | VA-C27 | 1812 | x3 |
|  | VA-C28 | 592 | x4 |
| | VA-C29 | 1812 | x1 |
|  | CN-A30 | | x4 |
|  | VA-38a | | x2 |
|  | VA-38b | | x2 |
|  | VA-39 | | x2 |
|  | VA-40 | | x1 |
|  | CN-A33 | | x2 |
|  | VA-35 | | x2 |
|  | PPX3 | | x4 |
|  | PPX4 | | x2 |
|  | PPX5 | | x2 |
|  | PPX8 | | x2 |
|  | PPX9 | | x2 |
|  | VA-D44 | | x231 |
|  | VA-D45 | | x102 |
|  | VA-D46 | | x8 |
|  | VA-D47 | | x4 |
|  | VA-D48 | | x4 |
|  | VA-D49 | | x8 |
|  | VA-D50 | | x10 |
|  | VA-51 | | x1 |

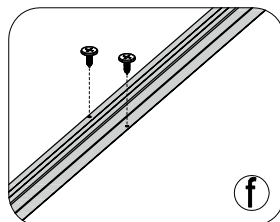
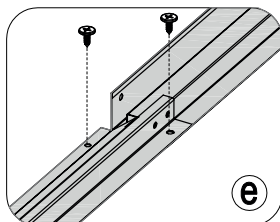
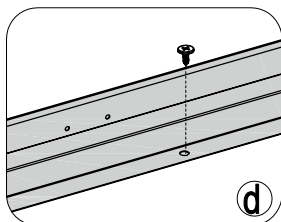
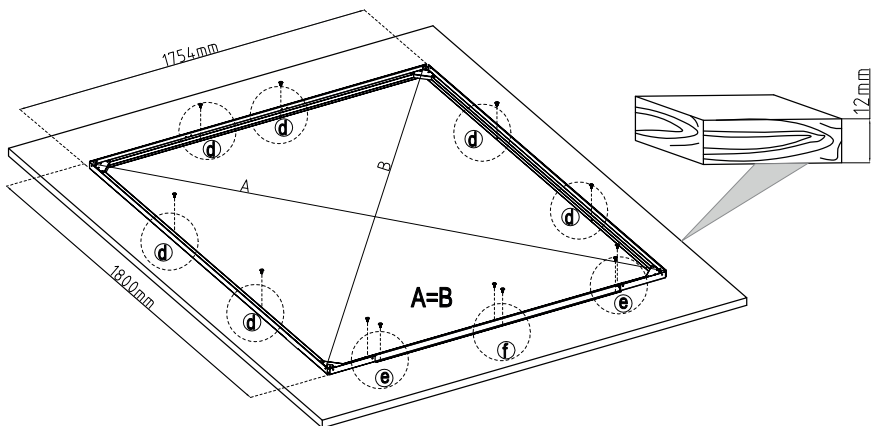
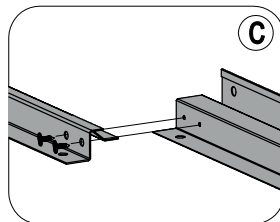
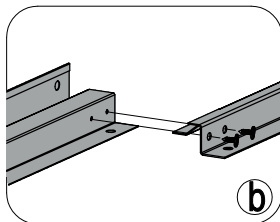
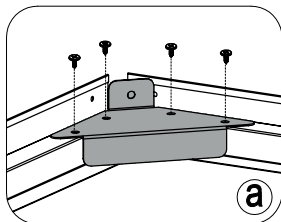
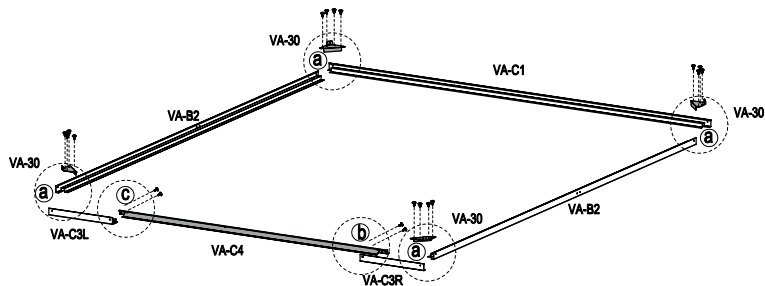
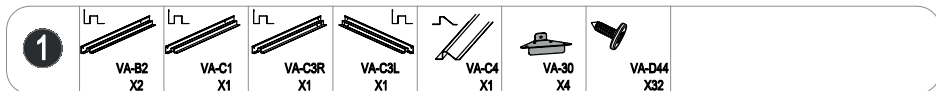

| | | | |
|----------|---|---|---|
| 2 |  VA-C7R X1 |  PB1 / PB1W X1 |  CN-A33 |
|----------|---|---|---|

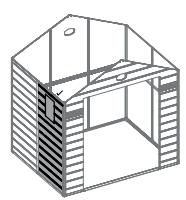
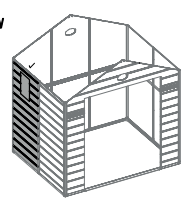
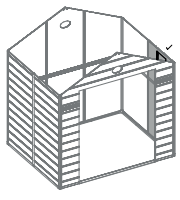
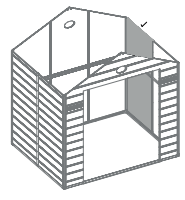
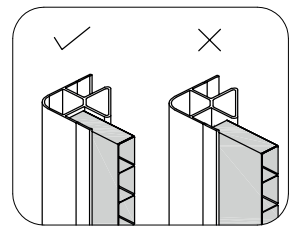
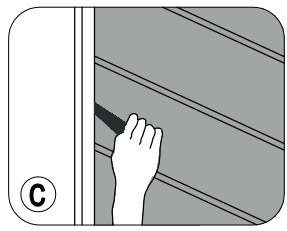
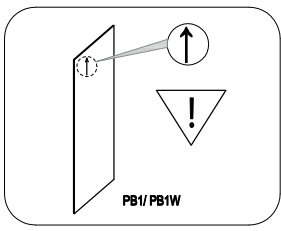
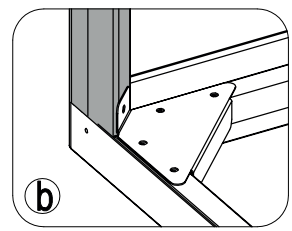
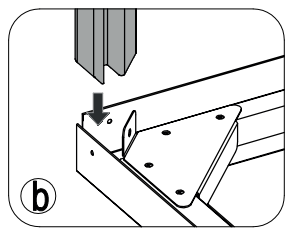
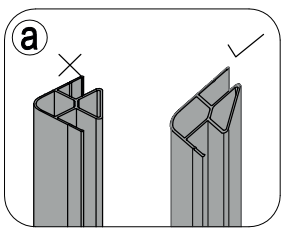
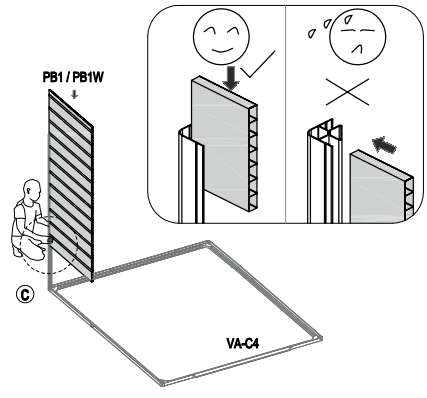
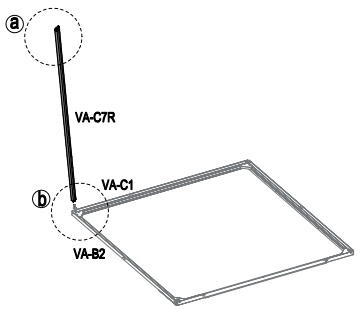

3



PB4
X1



VA-D45
X9



CN-A33

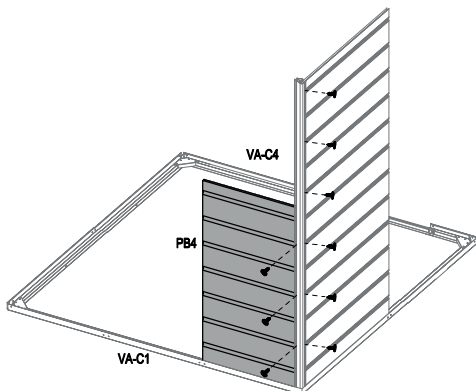
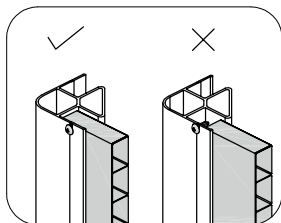
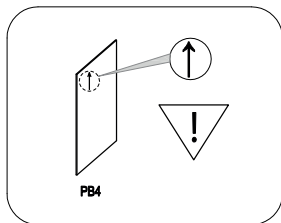

4

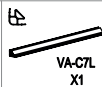

VA-C7L
X1



PB1 / PB1W
X1



CN-A33

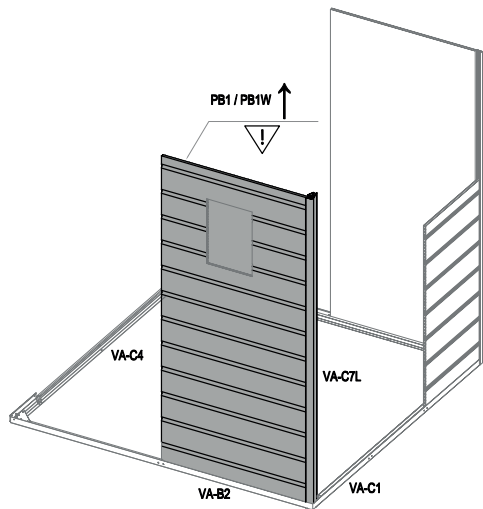

| | | | | |
|----------|---|---|---|--|
| 5 |  |  |  | |
| | PB4 X1 | VA-D45 X9 | CN-A33 | |

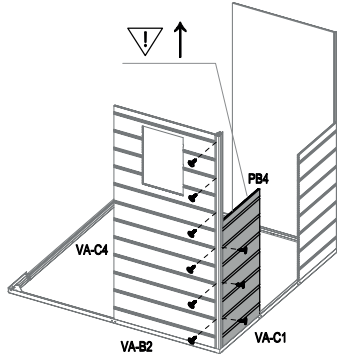
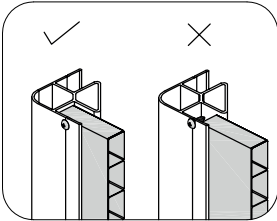



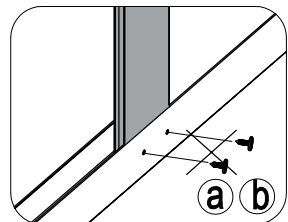
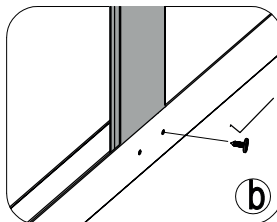
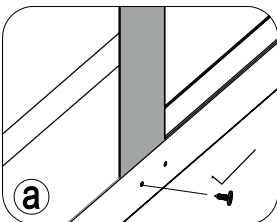
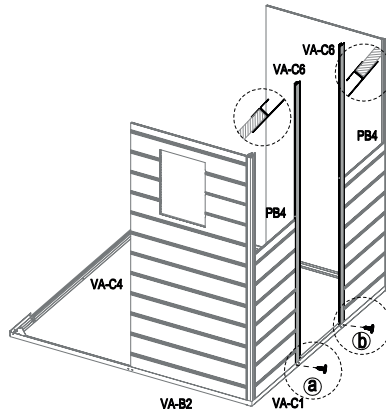
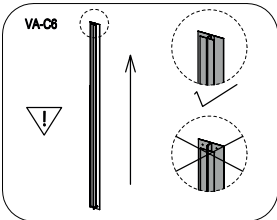

| | | | | |
|----------|---|---|---|--|
| 6 |  |  |  | |
| | VA-C6 X2 | VA-D44 X2 | CN-A33 | |

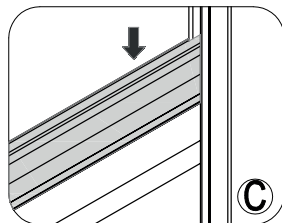
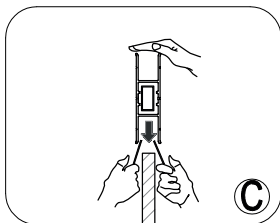
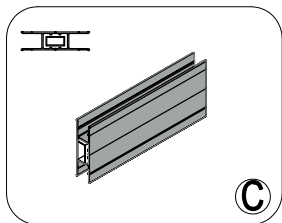
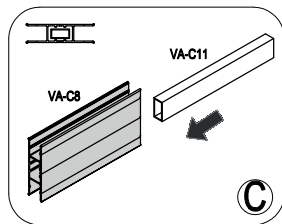
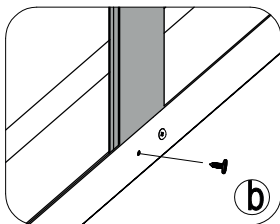
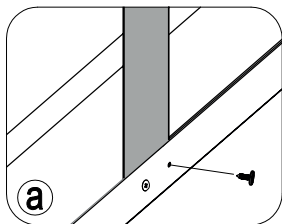
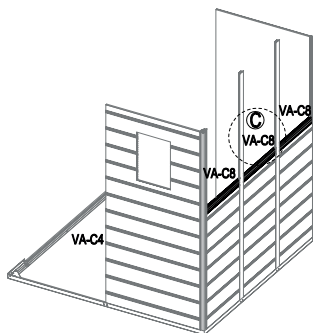
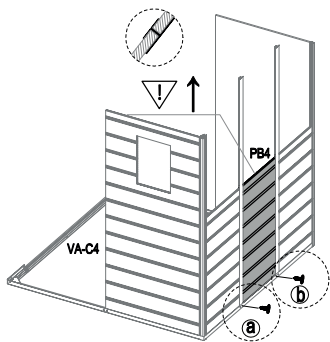

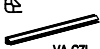



| | | | | | | |
|----------|---|---|---|---|---|--|
| 7 |  |  |  |  |  | |
| | PB4 X1 | VA-C11 X3 | VA-C8 X3 | VA-D44 X2 | CN-A33 | |

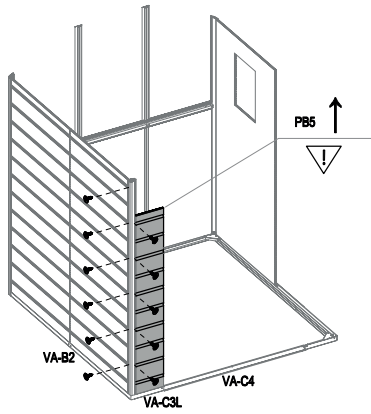
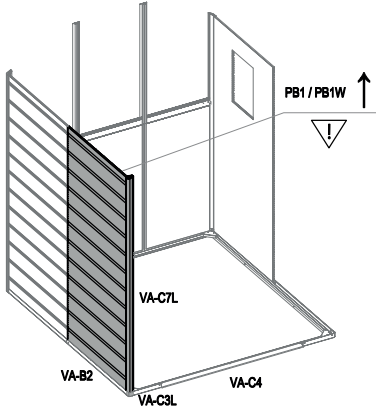

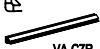
| | | | | | |
|----------|---|---|--|--|---|
| 8 |  VA-C7L X1 |  PB1 / PB1W X1 |  PB5 X1 |  VA-D45 X11 |  CN-A33 |
|----------|---|---|--|--|---|



| | | | | | |
|----------|---|---|--|--|---|
| 9 |  VA-C7R X1 |  PB1 / PB1W X1 |  PB5 X1 |  VA-D45 X11 |  CN-A33 |
|----------|---|---|--|--|---|

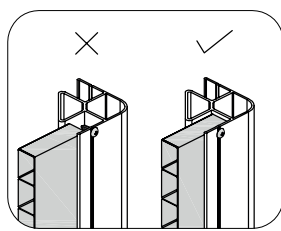
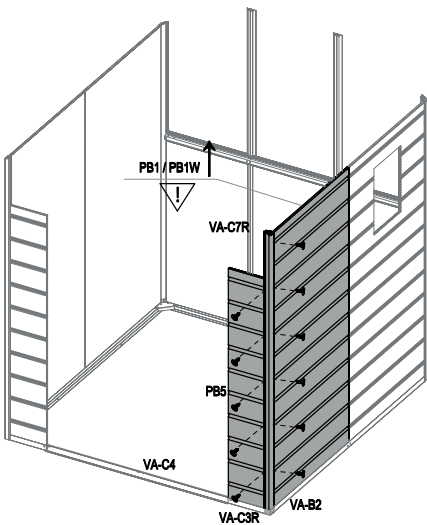

| | | | | | |
|-----------|---|---|---|--|--|
| 10 |  VA-31 X4 |  VA-C5 X2 |  VA-D44 X16 |  CN-A33 | |
|-----------|---|---|---|--|--|

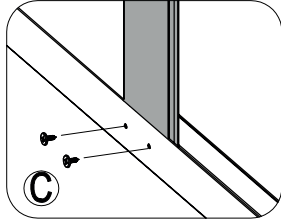
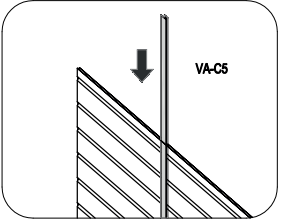
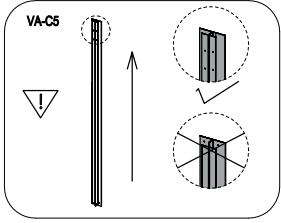
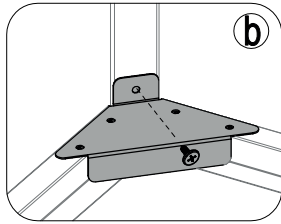
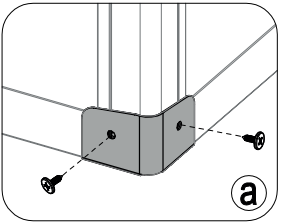
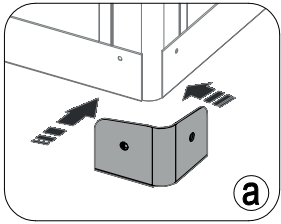
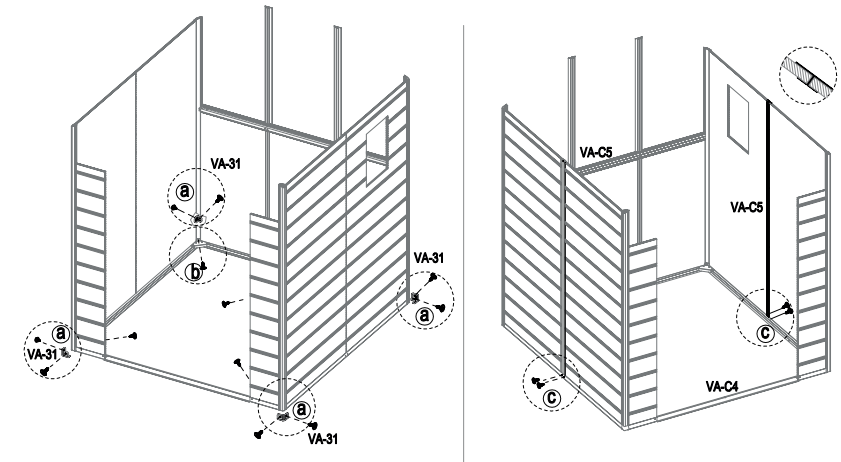

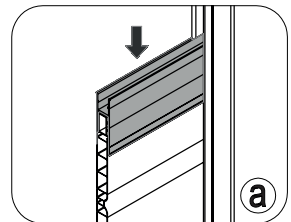
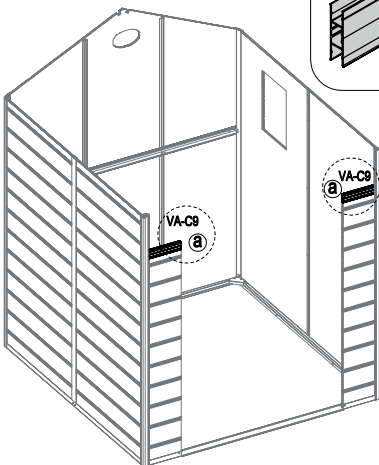
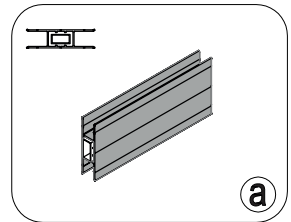
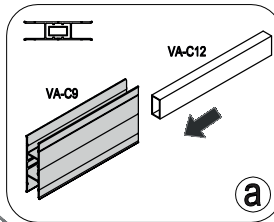
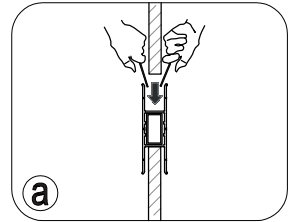
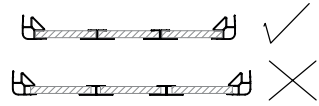
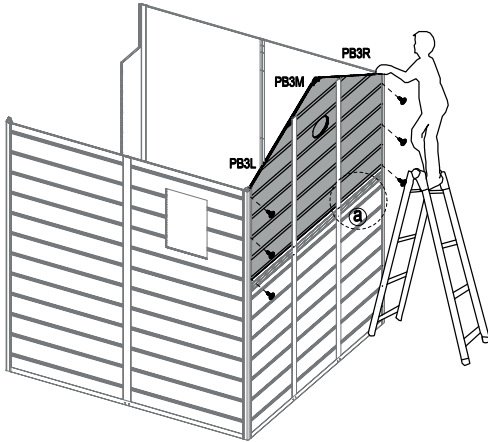
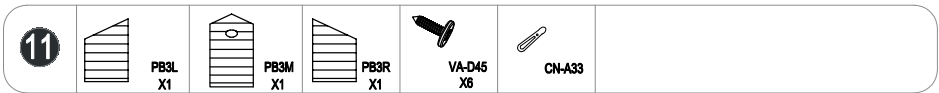

13



PB2
X1



VA-D45
X2



CN-A33

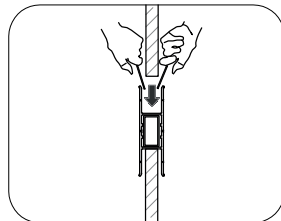
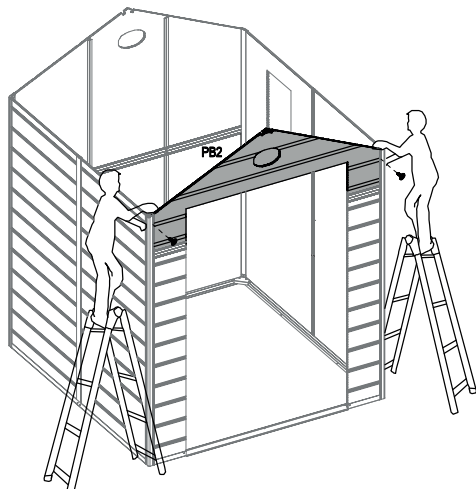

14



VA-33
X2



VA-34
X1



VA-D19
X2



VA-D20
X1





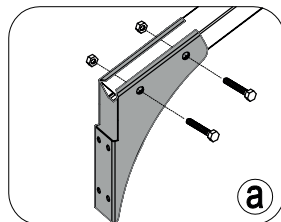
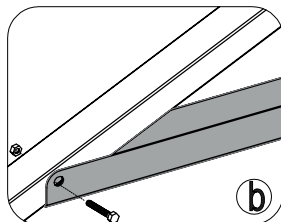
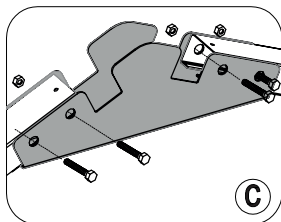
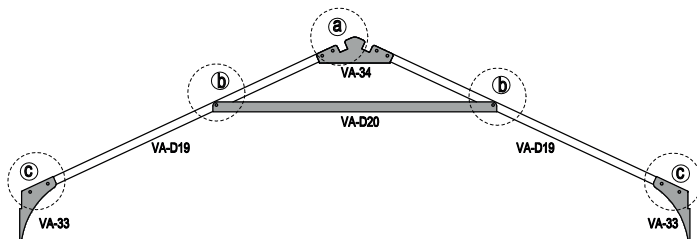



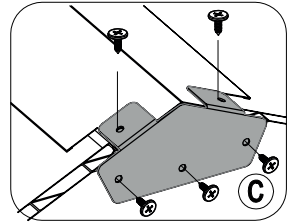
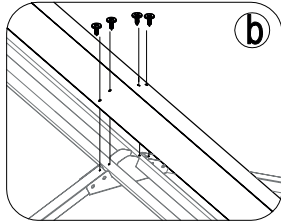
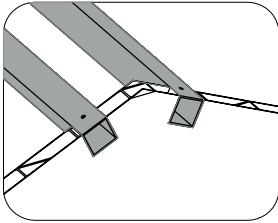
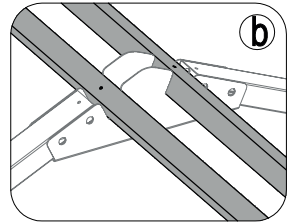
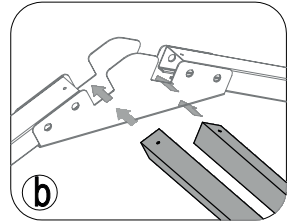
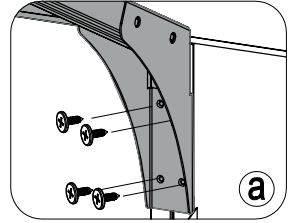
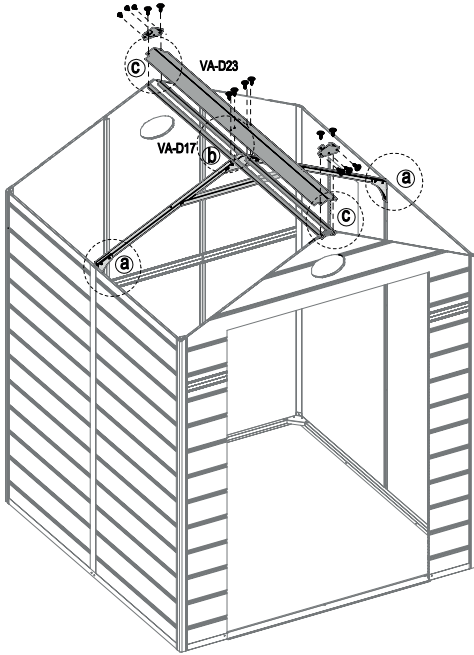

VA-D50
X10



- | | | | | | |
|-----------|--|---|---|--|--|
| 15 |  VA-35 X2 |  VA-D23 X1 |  VA-D17 X2 |  VA-D44 X22 | |
|-----------|--|---|---|--|--|



| | | | | | | | | |
|-----------|--|--|---|---|---|---|---|---|
| 16 |  VA-C25L X1 |  VA-C25R X1 |  VA-C26 X1 |  PPX8 X2 |  PPX9 X2 |  VA-D44 X4 |  VA-D46 X6 |  VA-D47 X4 |
|-----------|--|--|---|---|---|---|---|---|

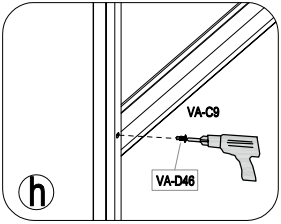
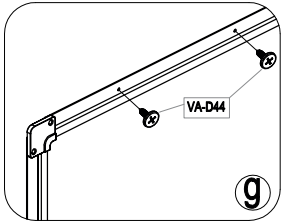
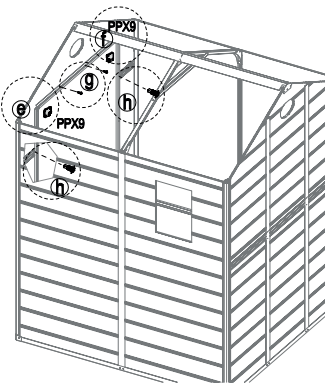
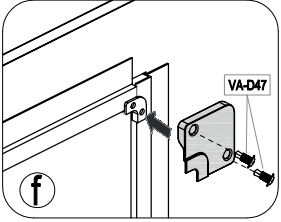
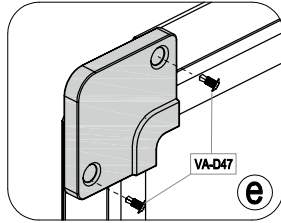
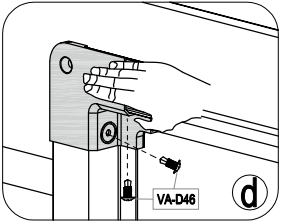
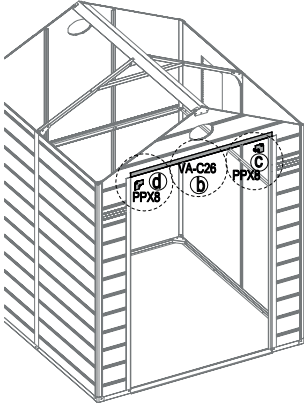
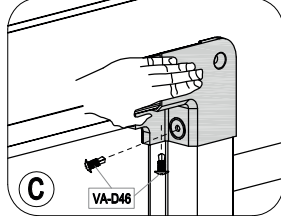
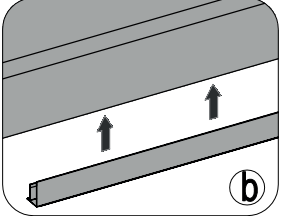
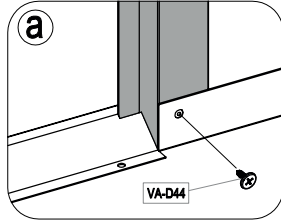
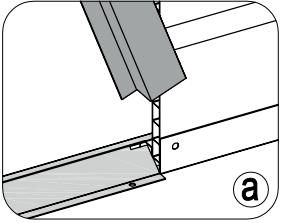
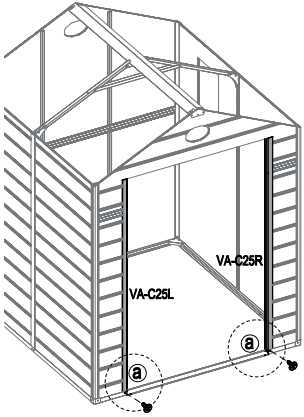

- | | | | | | | |
|----|--|--|---|--|--|--|
| 17 |  VA-B22 X2 |  VA-D21 X4 |  PB6-B X2 |  PPX3 X4 |  VA-D44 X8 |  CN-A33 |
|----|--|--|---|--|--|--|

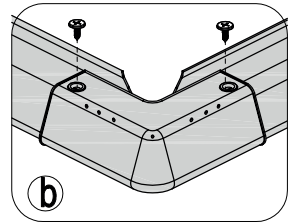
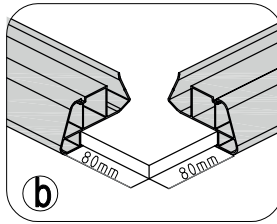
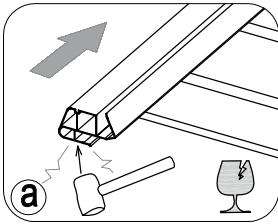
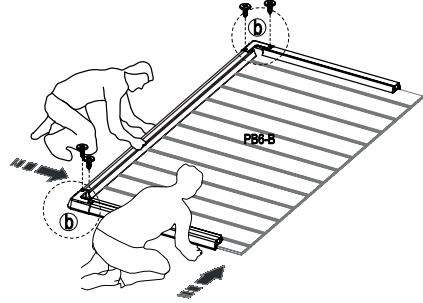
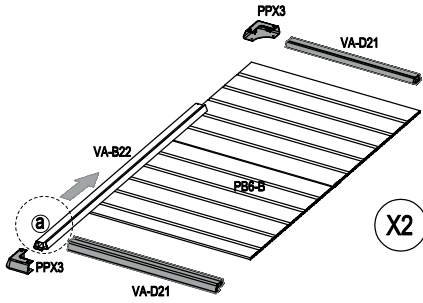

- | | |
|----|---|
| 18 |  VA-D45 X30 |
|----|---|

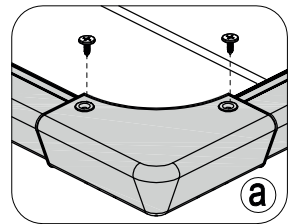
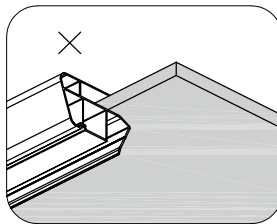
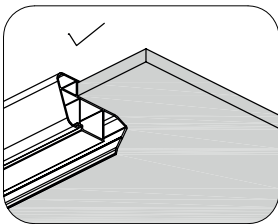
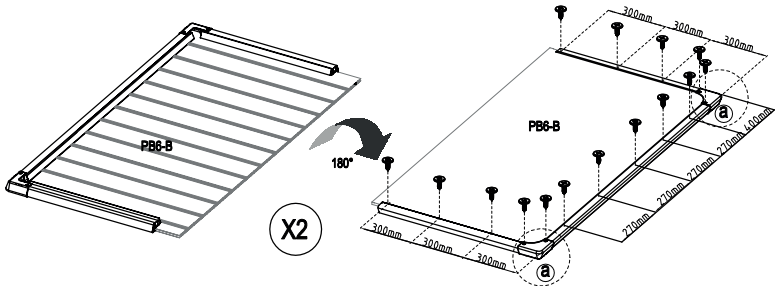

19



CN-A33

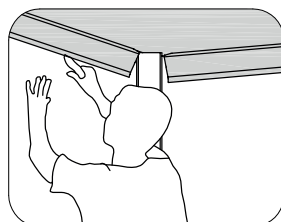
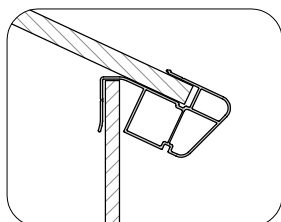
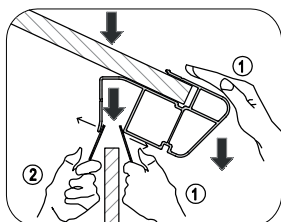
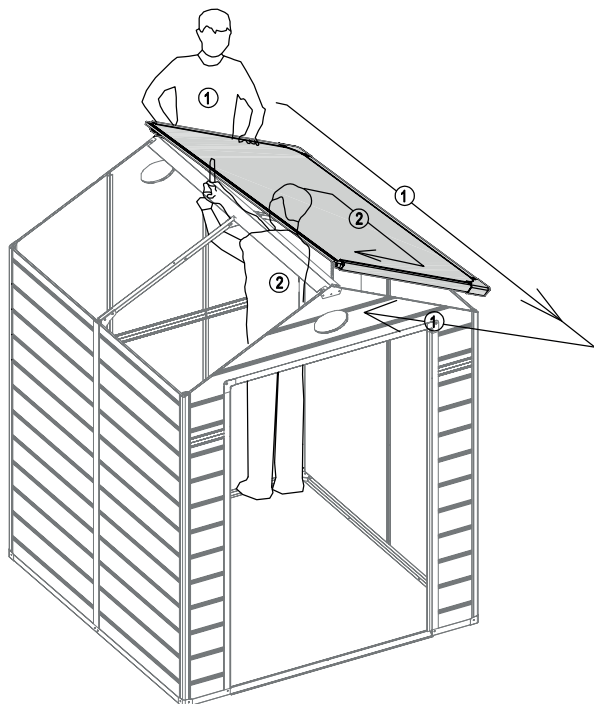

20



CN-A33

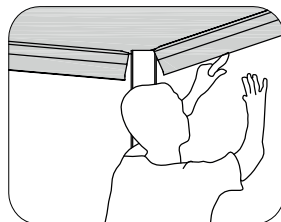
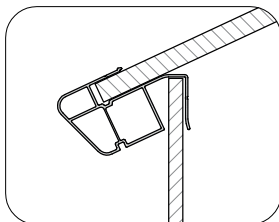
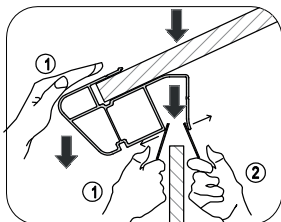
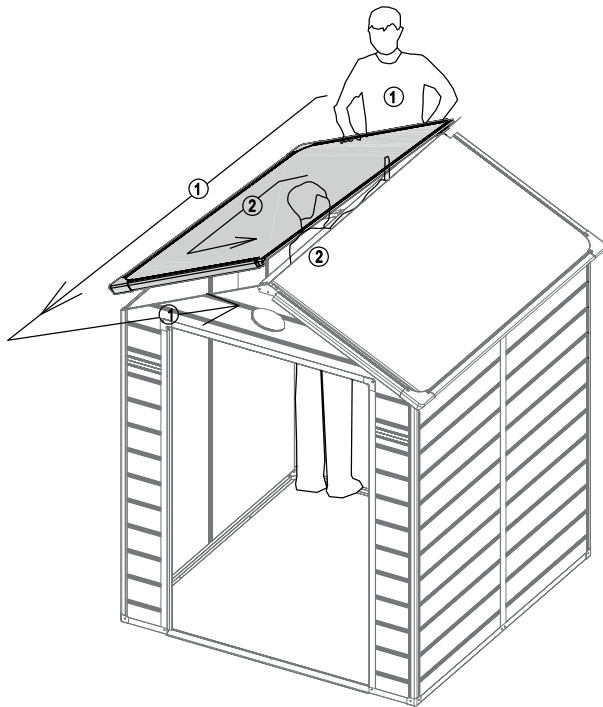

| | | | | | | |
|-----------|---|---|---|---|---|--|
| 21 |  |  |  |  |  | |
| | VA-B24 X1 | PPX4 X2 | VA-D44 X4 | VA-D45 X24 | VA-D46 X2 | |

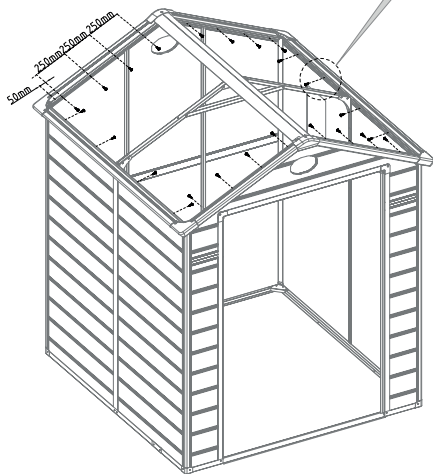
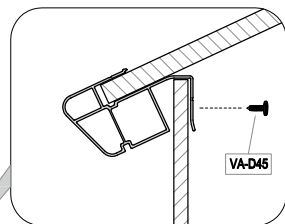
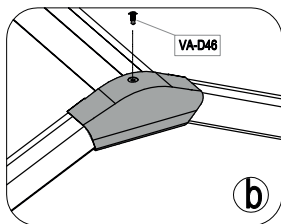
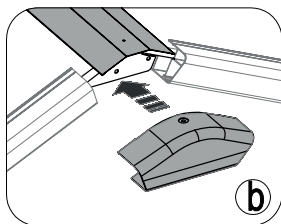
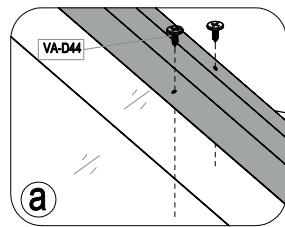
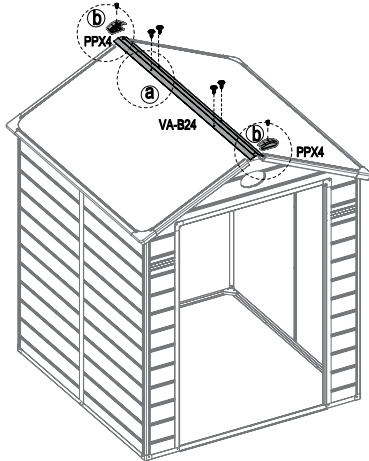

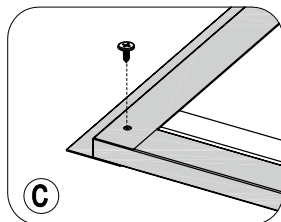
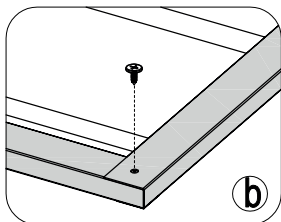
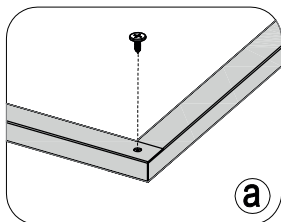
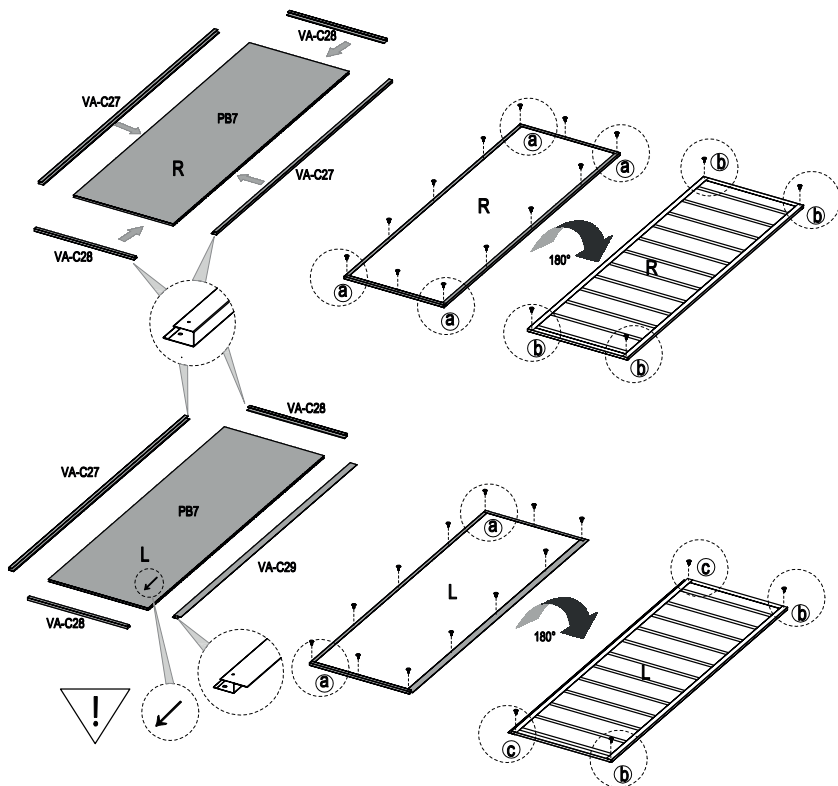

23



CN-A30
X4



VA-40
X1



VA-D44
X35

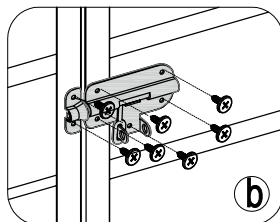
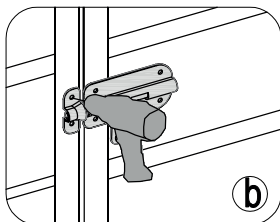
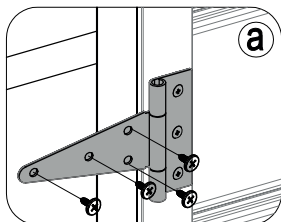
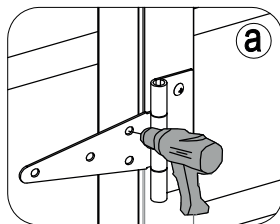
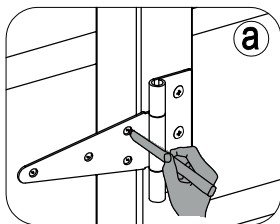
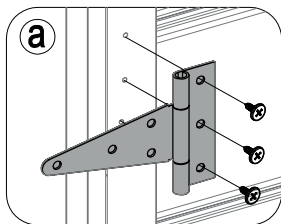
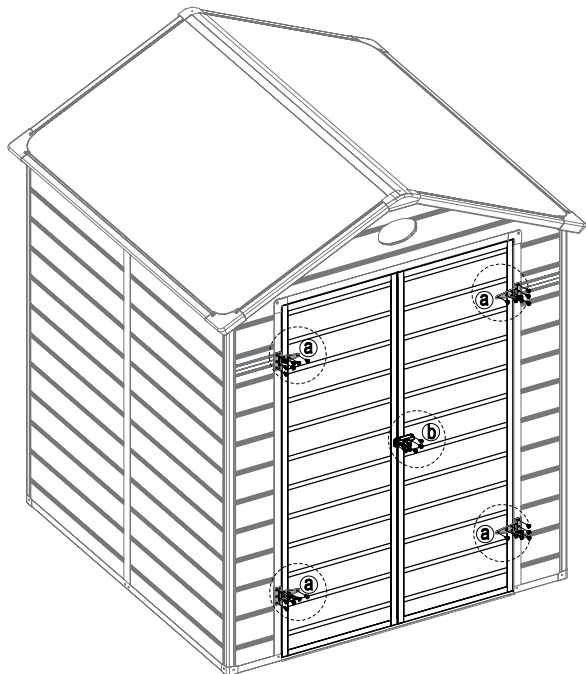

| | | | | | | | |
|-----------|---|---|---|---|---|---|--|
| 24 |  |  |  |  |  |  | |
| | VA-36 X2 | VA-37 X4 | VA-32R X2 | VA-32L X2 | VA-D44 X64 | VA-D48 X4 | |

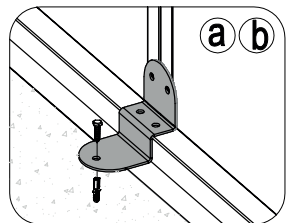
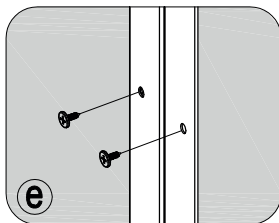
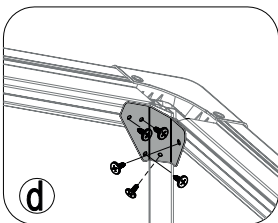
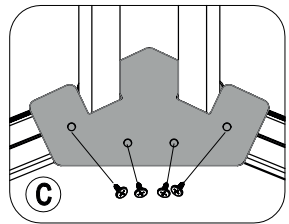
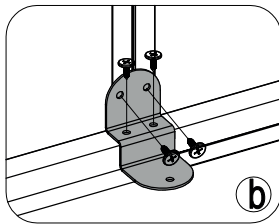
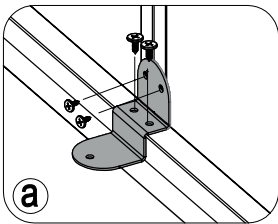
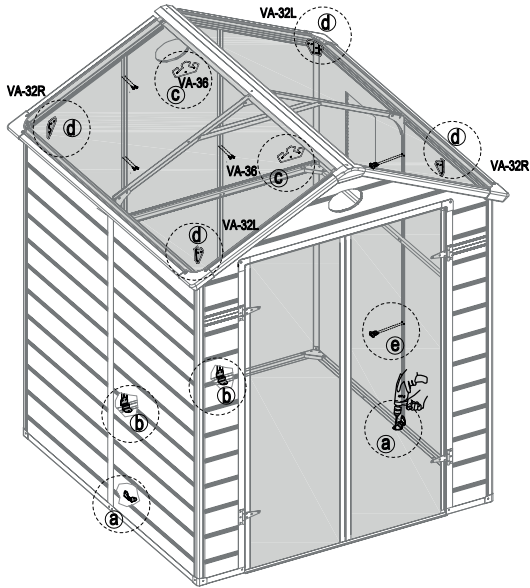

| | | | | | | |
|-----------|---|---|---|---|---|--|
| 25 |  |  |  |  |  | |
| | PPX5 X2 | VA-38a X2 | VA-38b X2 | VA-39 X2 | VA-D49 X8 | |

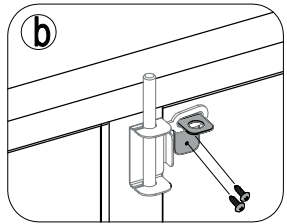
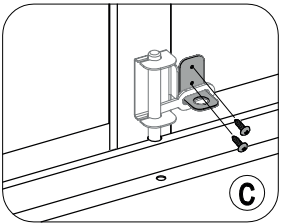
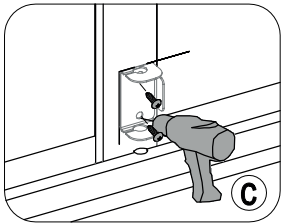
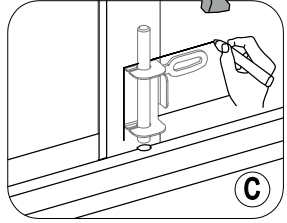
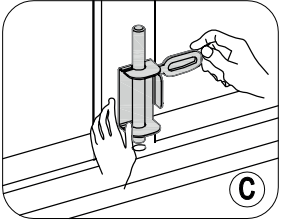
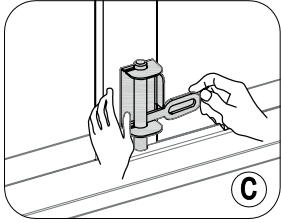
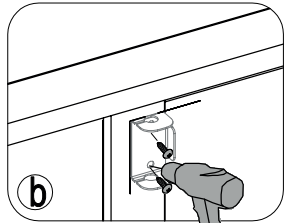
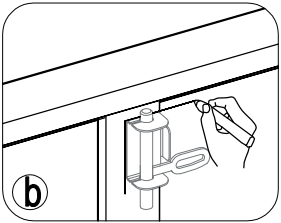
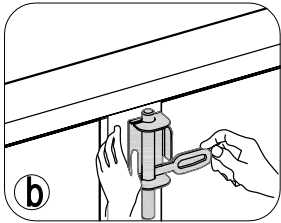
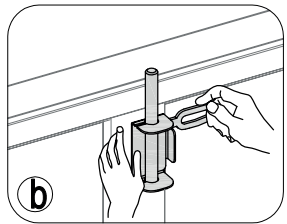
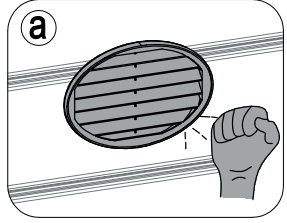
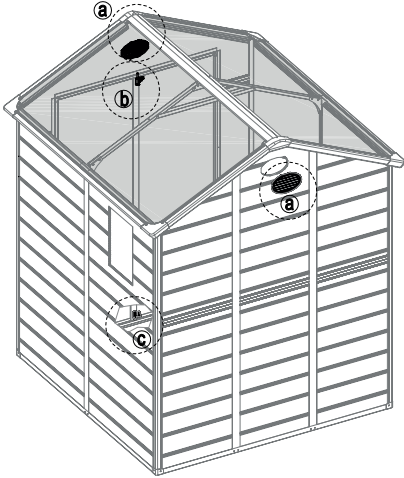

| | | | | | |
|-----------|---|---|--|--|--|
| 26 |  W1 X1 |  W2 X1 |  PPX10 X1 |  VA-51 X1 |  VA-D44 X10 |
|-----------|---|---|--|--|--|

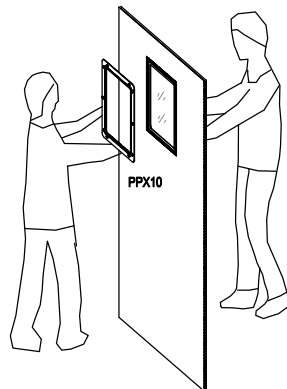
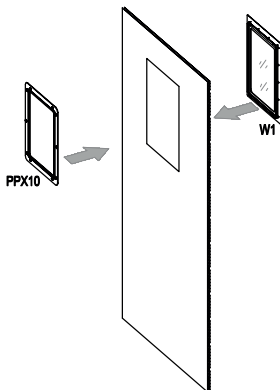
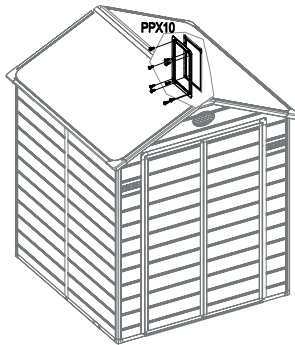
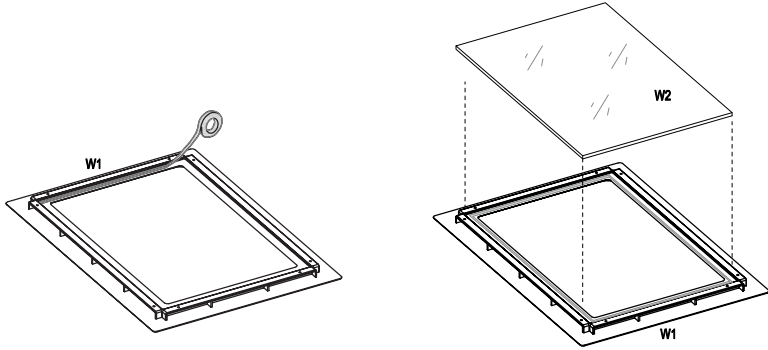

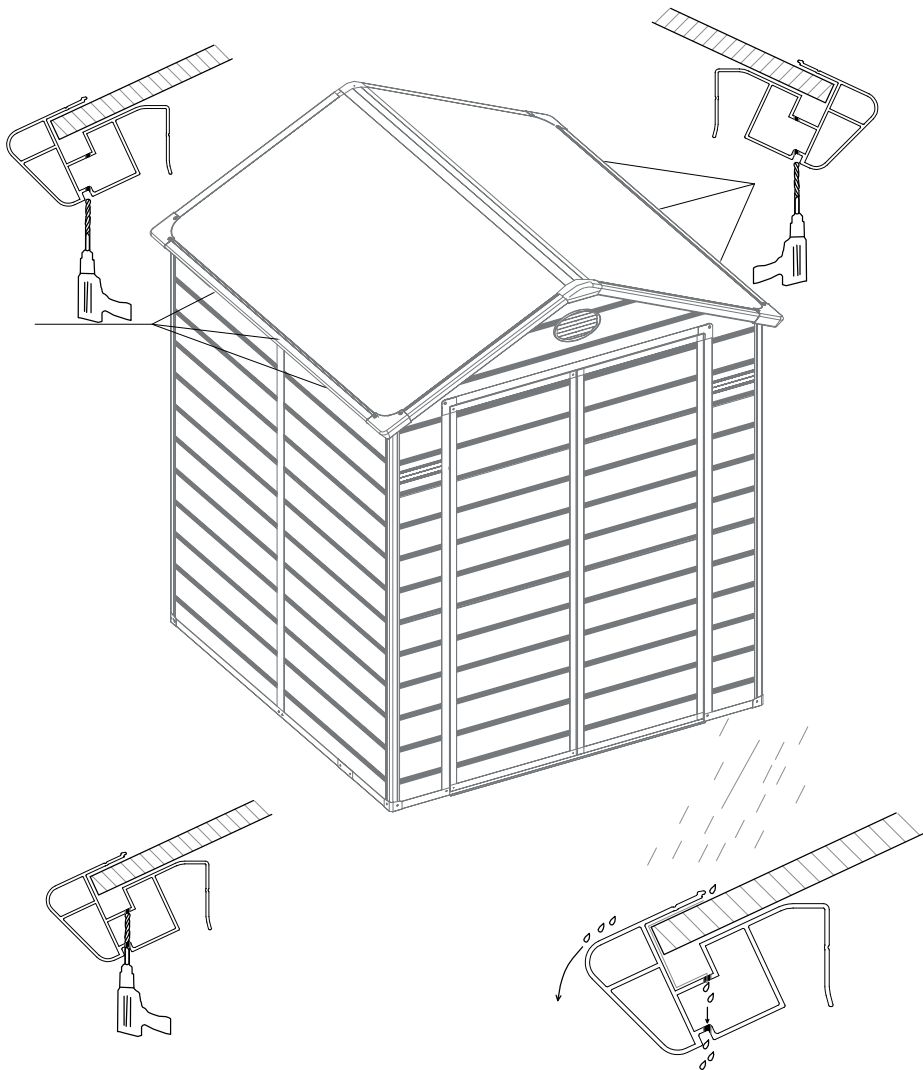

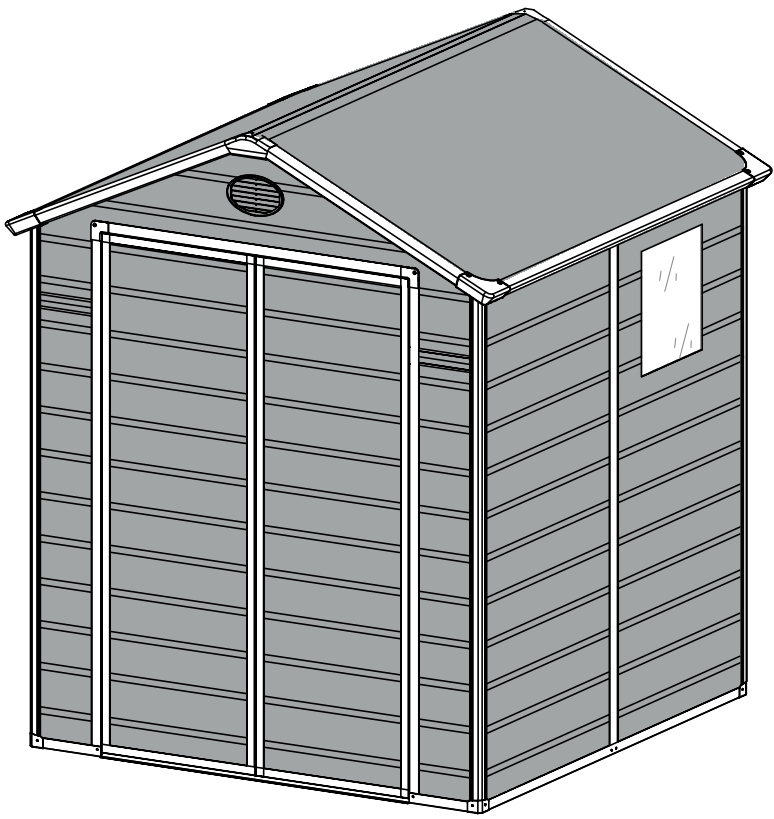

۲۷

