



BOSCH

Taille-Gazon

UniversalGrassCut 18-260 | 3 600 HC1 D02

Table des matières

Vue éclatée.....2

Vue éclatée - E

3 600 HC1 D00
 Issue | 19-08-07
 Stand | **Fig./Abb. 1**

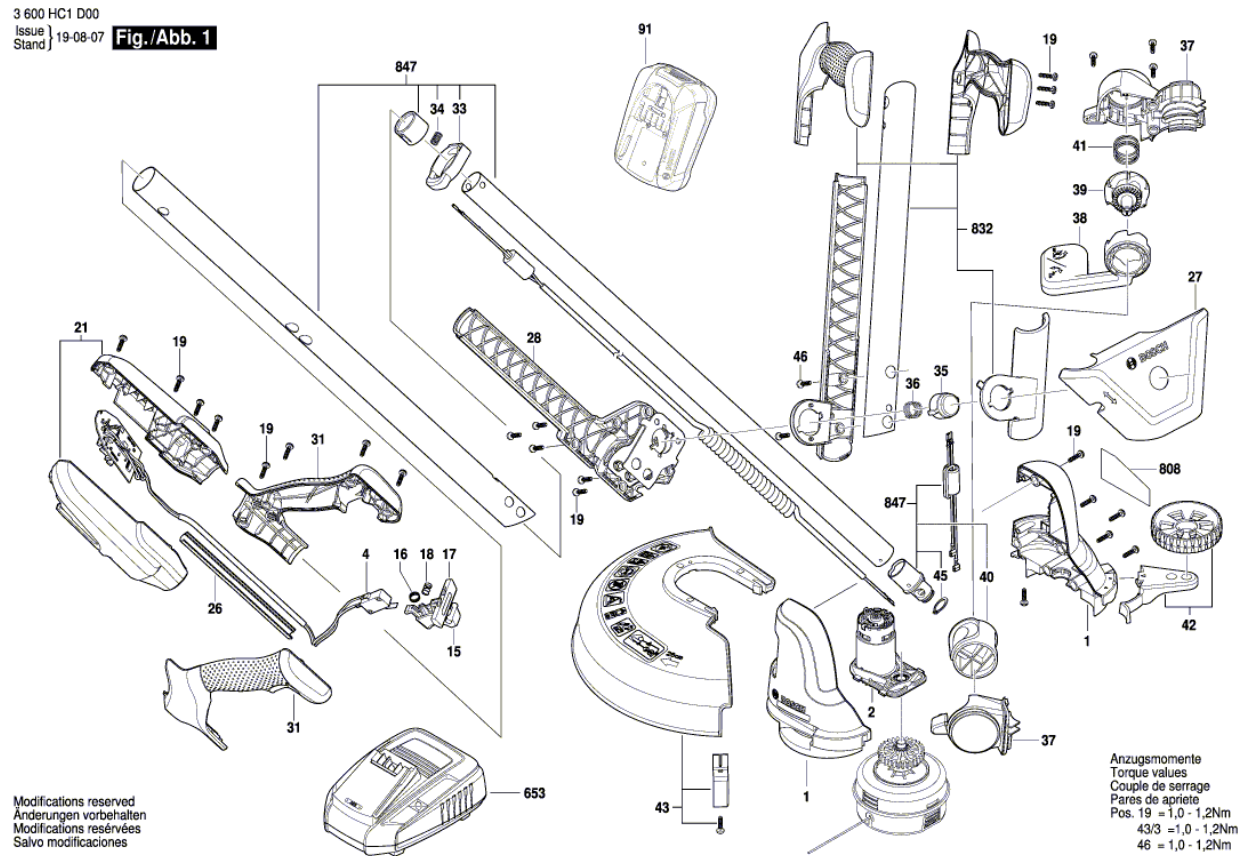

Modifications reserved
 Änderungen vorbehalten
 Modifications réservées
 Salvo modificaciones

Anzugsmomente
 Torque values
 Couple de serrage
 Pares de apriete
 Pos. 19 = 1,0 - 1,2Nm
 43/3 = 1,0 - 1,2Nm
 46 = 1,0 - 1,2Nm

Vue éclatée - E

3 600 HC1 D00
Issue | 19-03-16
Stand | **Fig./Abb. 2**

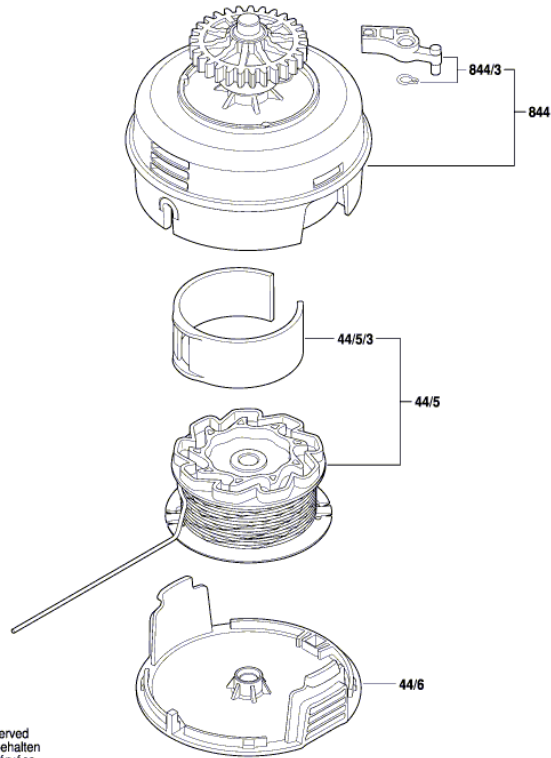

Modifications reserved
Änderungen vorbehalten
Modifications réservées
Salvo modificaciones

Vue éclatée - E

