

AXOR®

hansgrohe

- DE** Montageanleitung
FR Instructions de montage
EN assembly instructions
IT Istruzioni per Installazione
ES Instrucciones de montaje
NL Handleiding
DK Monteringsvejledning
PT Manual de Instalação
PL Instrukcja montażu
CS Montážní návod
SK Montážny návod
ZH 组装说明
RU Инструкция по монтажу
HU Szerelési útmutató
FI Asennusohje
SV Monteringsanvisning
LT Montavimo instrukcijos
HR Uputstva za instalaciju
TR Montaj kılavuzu
RO Instrucțiuni de montare
EL Οδηγία συναρμολόγησης
SL Navodila za montažo
ET Paigaldusjuhend
LV Montāžas instrukcija
SR Uputstvo za montažu
NO Montasjeveiledning
BG Инструкция за употреба
SQ Udhëzime rreth montimit
AR تعليمات التجميع

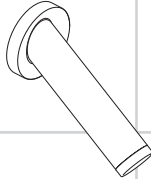

Starck
10410XXX

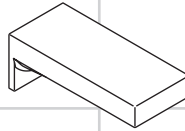

Starck X
10426000

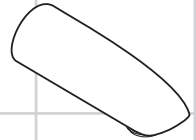

Arco
11410XXX

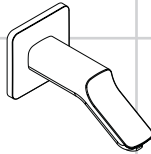

Urquiola
11430000
11431000

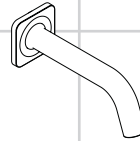

Citterio M
34410000
34411000

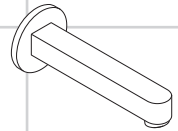

Steel
35412800

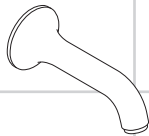

Terrano
37410XXX

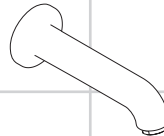

Uno
38410XXX

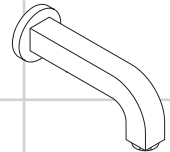

Citterio
39410XXX
39411XXX

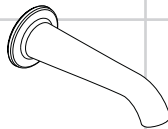

Bouroullec
19415000
19416000

Starck 10410XXX

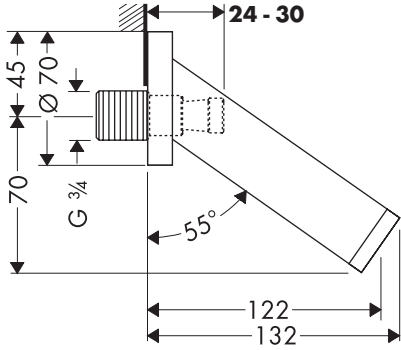

Starck X 10426000

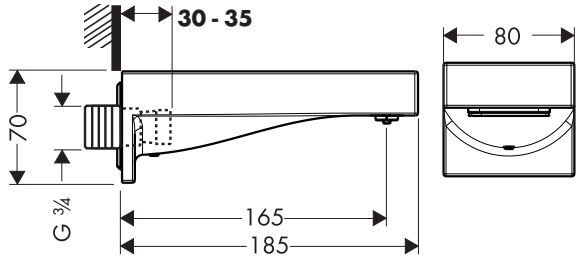

Urquiola 11430000

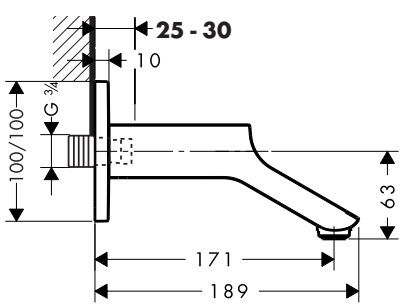

Urquiola 11431000

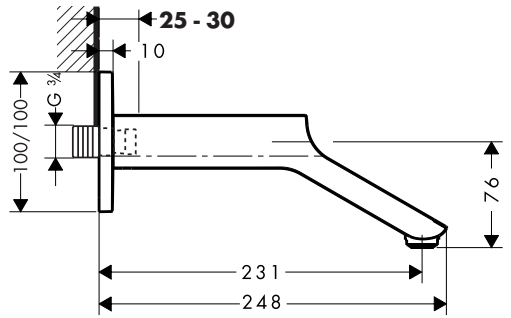

Uno 38410XXX

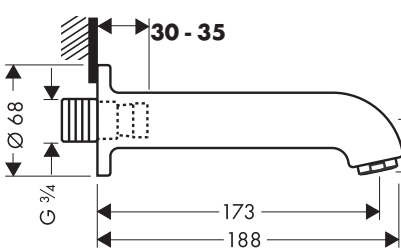

Steel 35412800

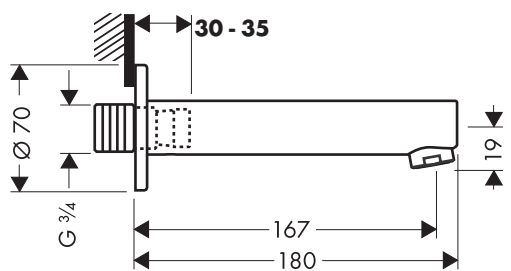

Terrano 37410XXX

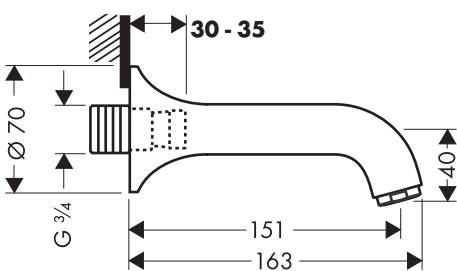

Arco 11410XXX

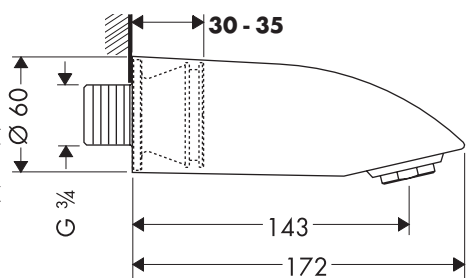

Citterio M 34410000

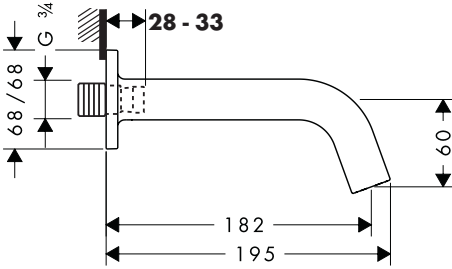

Citterio M 34411000

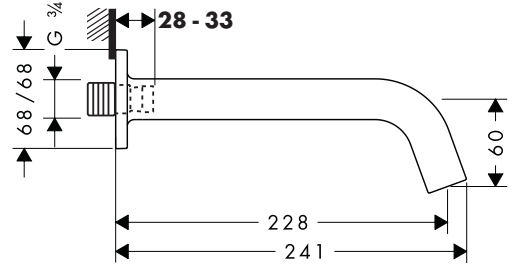

Citterio 39410XXX

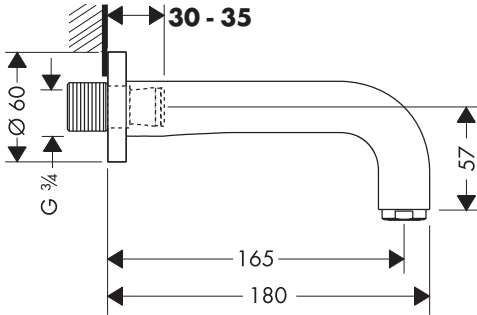

Citterio 39411XXX

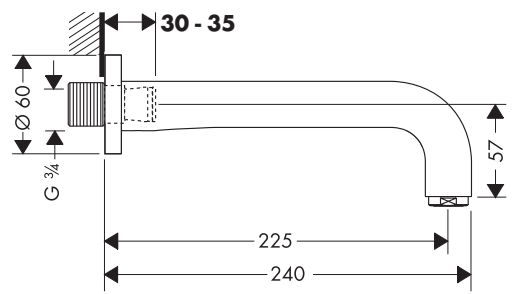

Bouroullec 19415000

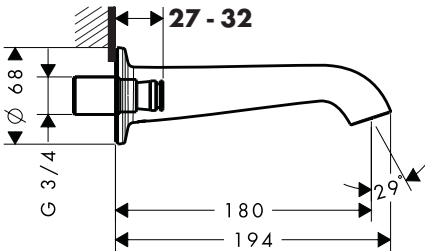

Bouroullec 19416000

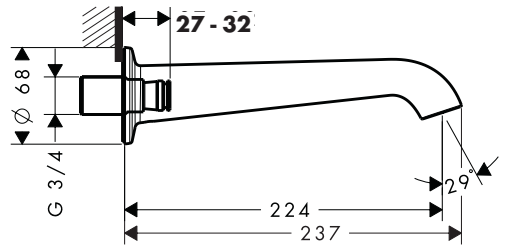

	P-IX	SVGW	ACS	WRAS
10410000				X
10426000	9918/IIO		X	X
11430000	19241/IB	X	X	X
11431000	19241/IB	X	X	X
38410000	18850/IB		X	X
35412800				X
34410000		X	X	X
34411000		X	X	X
37410000				X
11410000				X
39410000				X
39411000				X
19415000				
19416000				



10426000

11430000 /
11431000

38410XXX

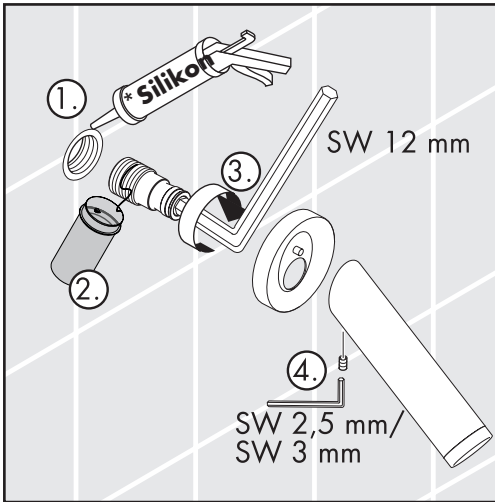

- DE** Silikon (essigsäurefrei!)
- FR** Silicone (sans acide acétique!)
- EN** Silicone (free from acetic acid!)
- IT** Silicone (essente da acido acetico!)
- ES** Silicona (¡libre de ácido acético!)
- NL** Silicone (azijnzuurvrij!)
- DK** Silikone (eddikesyre-fri)
- PT** Silicone (sem ácido acético)
- PL** Silikon (neutralny)
- CS** Silikon (bez kyseliny octové!)
- SK** Silikon (bez kyseliny octovej!)
- ZH** 硅胶 (不含醋酸)
- RU** Силикон (не содержит уксусной кислоты!)
- HU** Szilikon (ecetsavmentes!)
- FI** Silikoni (etikkahappovapaa!)
- SV** Silikon (fri från ättiksyra!)
- LT** Silikonas (be acto rūgšties!)
- HR** Silikon (ne sadrži kiseline)
- TR** Silikon (asetik asit içermeyen)
- RO** Silicon (fără acid acetic!)
- EL** Σιλικόνη (δίχως οξικό οξύ!)
- SL** Silikon (brez očetne kisline)
- ET** Silikoon (äädikhappeta!)
- LV** Silikons (etiķskābi nesaturošis!)
- SR** Silikon (ne sadrži sircetnu kiselinu!)
- NO** Silikon (uten eddiksyre)
- BG** Силикон (без оцетна киселина!)
- SQ** Silikon (pa acid uthulle!)
- AR** (!الفيلخلا ضمح نم يلاخ) نوكييليس

hansgrohe