

Montageanleitung



Metropol E
14475XXX/
14477XXX



Metris E
31475000/
31476000



Focus E
31744000



Talis E
33455000/
33457000



Metropol E
14675XXX



Metris E
31675000



Focus E
31761000



Talis E
33655000

hangrohe

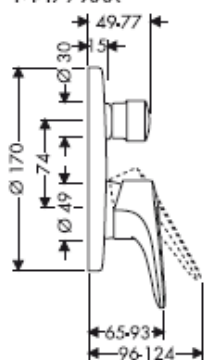
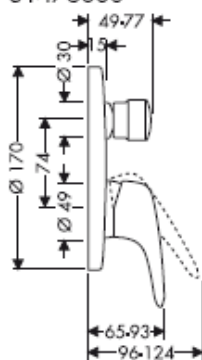
Metropol E14475XXX/
14477XXX**Metris E**31475000/
31476000**Focus E**

31744000

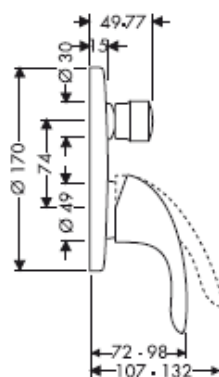
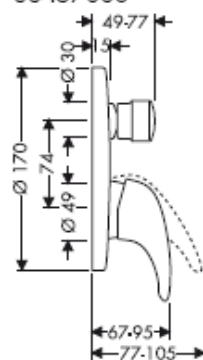
**Talis E**33455000/
33457000**Metropol E**

14675XXX

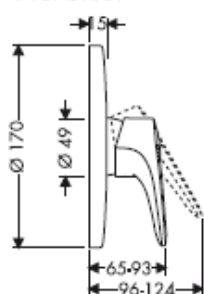
**Metris E**

31675000

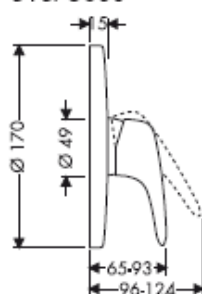
**Focus E**

31761000

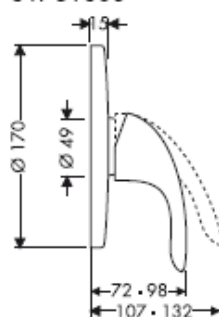
**Talis E**

33655000

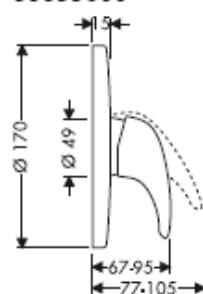

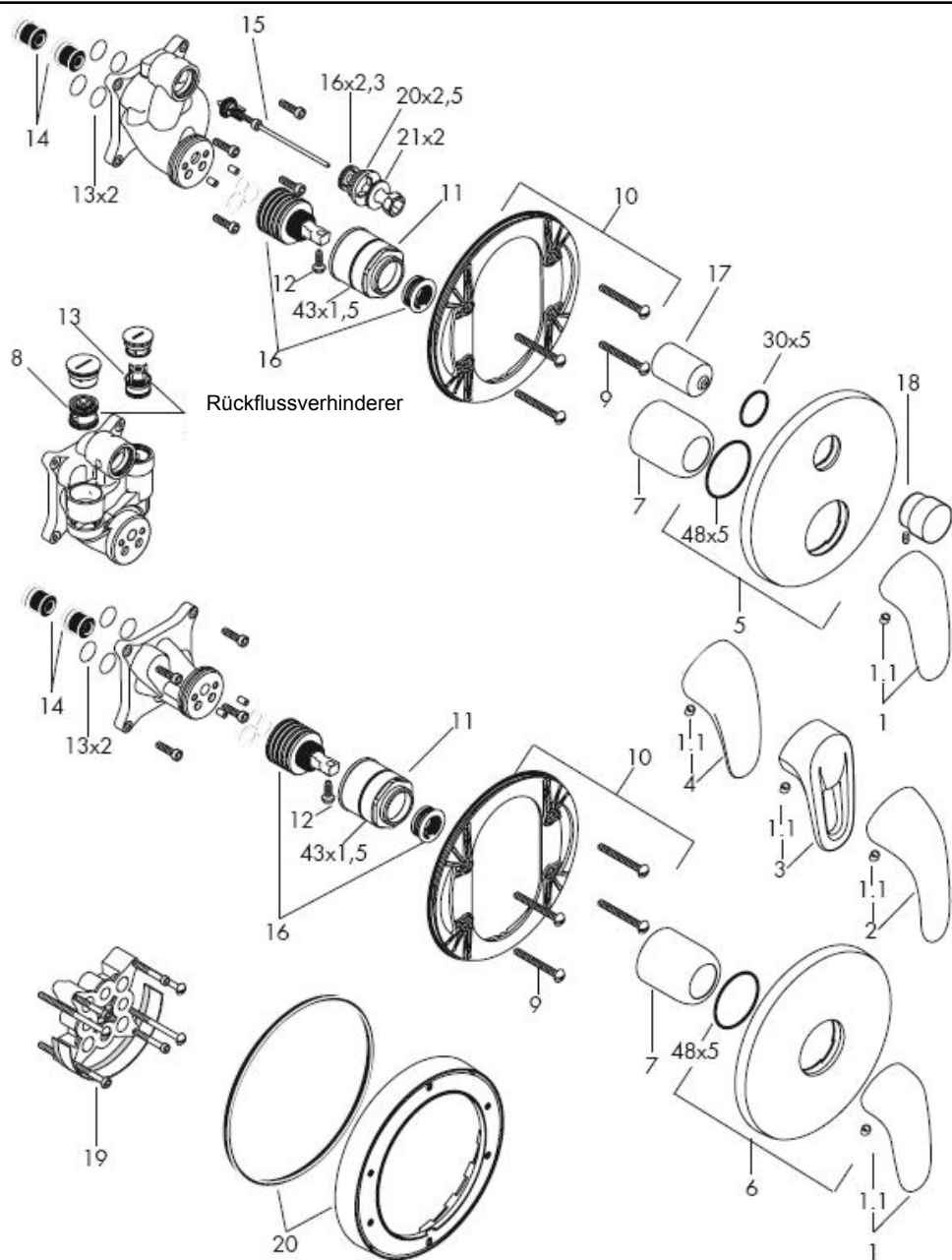

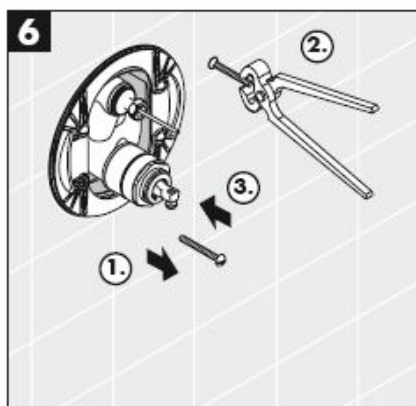
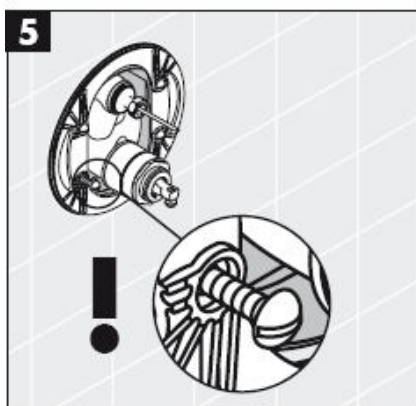
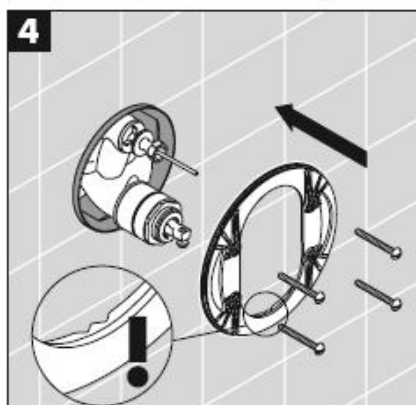
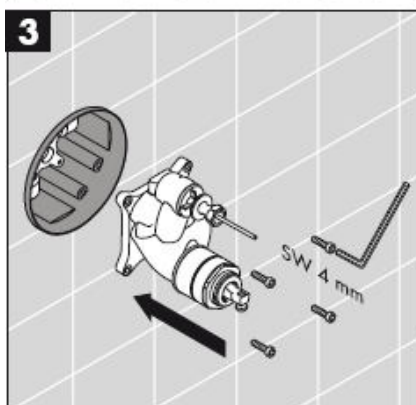
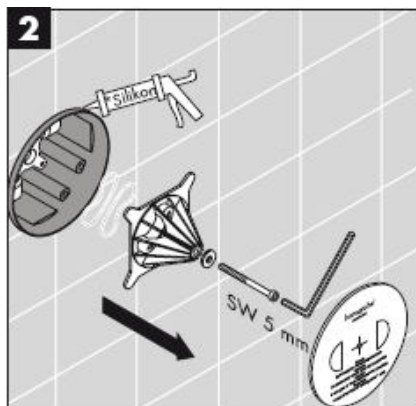
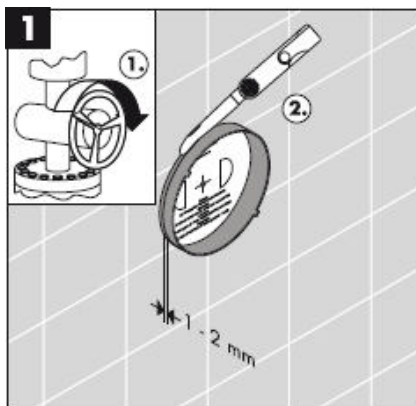

*Silikon (essigsäurefrei!)

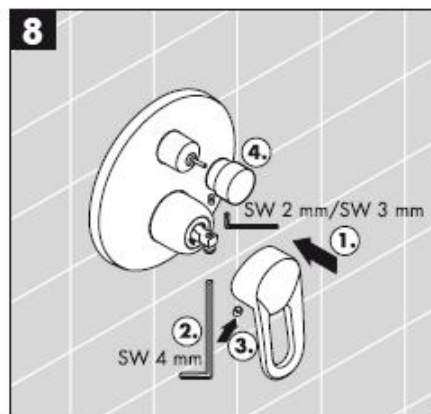
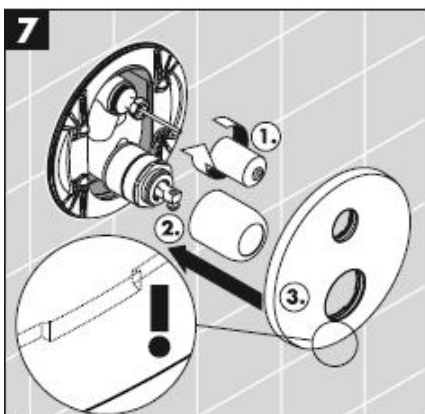

Montage

Achtung! Die Armatur muss nach den gültigen Normen montiert, gespült und geprüft werden!

Bedienung

Durch Ziehen am Griff wird der Mischer geöffnet. Schwenkung nach links = warmes Wasser, nach rechts = kaltes Wasser.

Umstellen zur Handbrause durch Ziehen am Umstellernopf. Die Rückstellung erfolgt nach Schließen des Griffes automatisch.

Technische Daten

Betriebsdruck:	max. 1 MPa
Empfohlener Betriebsdruck:	0,1 – 0,5 MPa
Prüfdruck:	1,6 MPa
(1 MPa = 10 bar = 147 PSI)	
Heißwassertemperatur:	max. 80° C
Empfohlene Heißwassertemperatur:	65° C
Durchflussleistung: 0,3 MPa	
14475XXX / 14477XXX /	
31475000 / 31476000 /	
31744000 / 33455000 / 33457000:	
Abgang Wanne	ca. 30 l/min
Abgang Brause	ca. 24 l/min
14675XXX / 31675000 /	
31761000 / 33665000:	ca. 32 l/min
Eigensicher gegen Rückfließen:	14477XXX
	31476000
	33457000

Hansgrohe Einhandmischer können in Verbindung mit hydraulisch und thermisch gesteuerten Durchlauferhitzern eingesetzt werden wenn der Fließdruck mindestens 0,15 MPa beträgt.

Einhandmischer mit Warmwasserbegrenzung, Justierung siehe Seite 8.

In Verbindung mit Durchlauferhitzern ist eine Warmwassersperre nicht notwendig.

In Verbindung mit Durchlauferhitzern darf keine Warmwassersperre eingebaut sein!

Da bei einem Defekt der Funktionsteile Wasser an der ibox austreten kann, muss die ibox über der Wanne montiert werden, damit austretendes Wasser in die Wanne abfließen kann!

Die Sicherheitseinrichtungen der Armaturen 14477XXX/31476000/33457000 müssen einmal jährlich auf ihre Funktion geprüft werden.

Rückflussverhinderer müssen gemäß DIN EN 1717 regelmäßig in Übereinstimmung mit nationalen oder regionalen Bestimmungen (DIN 1988 einmal jährlich) auf ihre Funktion geprüft werden.

Serviceteile siehe Seite 3

1	Griff Metris E	31094XXX
1.1	Griffstopfen	96338000
2	Griff Focus E	31791000
3	Griff Metropol E	14094XXX
4	GriffTalis E	33091000
5	Rosette	96453XXX
6	Rosette	96452XXX
7	Kugelrosette E	95010XXX
8	Rohrbelüfter	96753000
9	Trägerschrauben (4)	96454000
10	Trägerrosette	96447000
11	Mutter	95007000
12	Sicherungsschraube	96059000
13	Rückflussverhinderer	96655000
14	Schalldämpfer	94073000
15	Umsteller kpl.	95014000
16	Kartusche kpl.	92730000
17	Umstellerhülse	96448000
18	Zugknopf	95013XXX
19	Verlängerung 25 mm	13595000
20	Verlängerung 22 mm	13596000

XXX = Farbcodierung

000	chrom
090	chrom/gold

Prüfzeichen

	DVGW	P-IX	SVGW	NF	WRAS	KIWA
14475XXX	X	PA-IX 9709/ICC	X		X	
14477XXX		PA-IX 18097/IDC				
14675XXX	X	PA-IX 9710/IB	X		X	
31475000	X	PA-IX 9709/ICC	X		X	
31476000		PA-IX 18097/IDC				
31675000	X	PA-IX 9710/IB	X			
31744000	X	PA-IX 9709/IDC	X			
31761000	X	PA-IX 9710/IB	X		X	
33455000	X	PA-IX 9709/IDC	X	X	X	X
33457000	X	PA-IX 18097/IDC	X	X		
33655000	X	PA-IX 9710/IB	X	X		X

Störung

Ursache

Abhilfe

Armatur schwergängig	-Kartusche defekt, verkalkt	-Kartusche austauschen
Armatur tropft	-Kartusche defekt, Ablagerungen	-Kartusche austauschen
Umsteller funktioniert nicht	-Zu geringer Wasserdruck -Umsteller defekt	-Wasserdruck erhöhen -Umsteller austauschen
Zu niedere Warmwassertemperatur, kein Kaltwasser.	-Warmwasserbegrenzung falsch eingestellt	-Warmwasserbegrenzung einstellen
Durchlauferhitzer springt an, wenn Kaltwasser angewählt wird.	-Kreuzfluss	-Kartusche austauschen

Warmwasserbegrenzung: Warmwassertemperatur 60 C, Kaltwassertemperatur 10 C, Fließdruck 0,3 MPa.

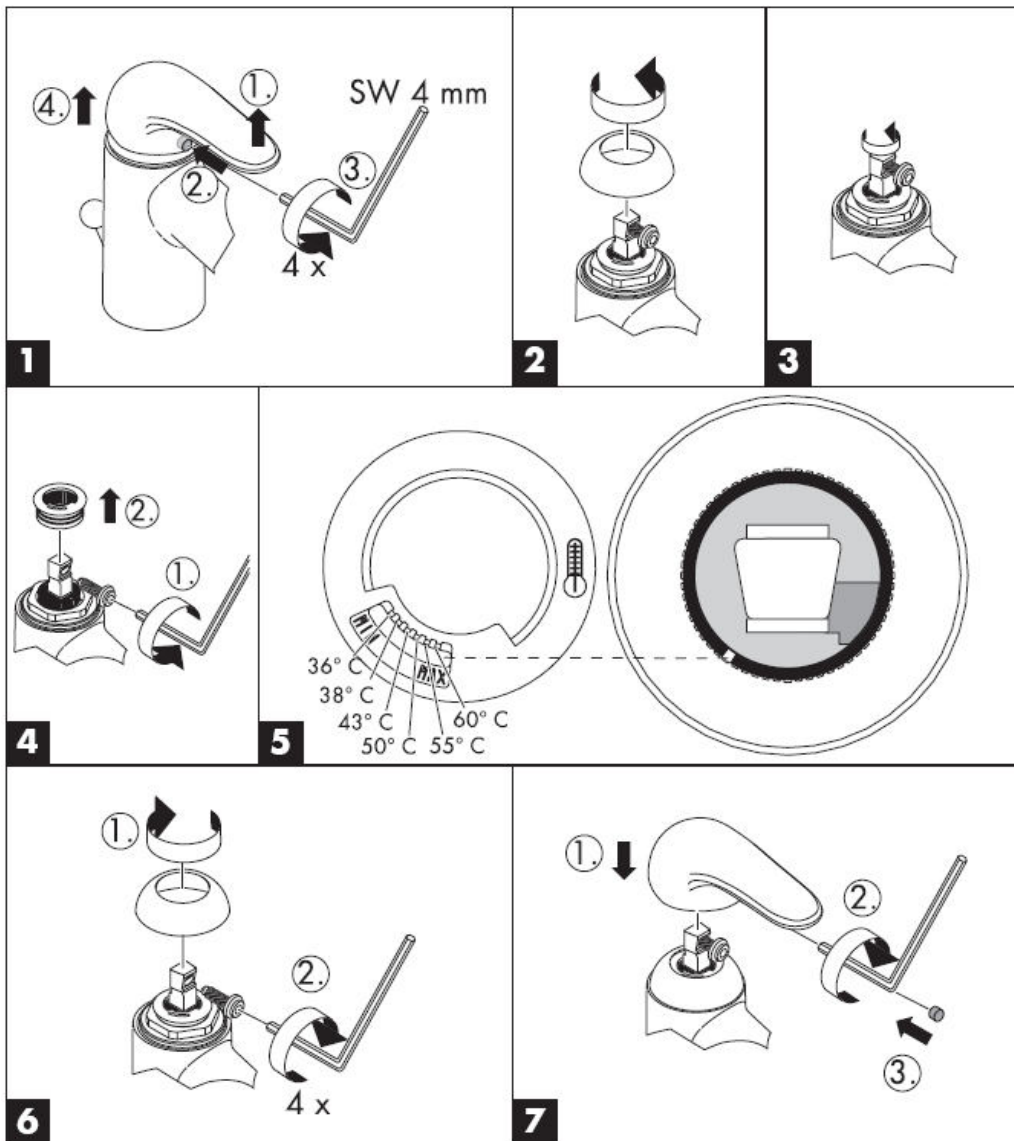

Instructions de montage



Metropol E
14475XXX/
14477XXX



Metris E
31475000/
31476000



Focus E
31744000



Talis E
33455000/
33457000



Metropol E
14675XXX



Metris E
31675000



Focus E
31761000



Talis E
33655000

hansgrohe

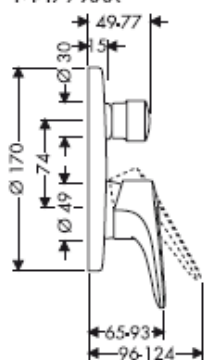
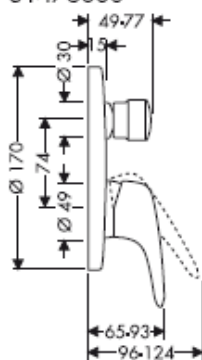
Metropol E14475XXX/
14477XXX**Metris E**31475000/
31476000**Focus E**

31744000

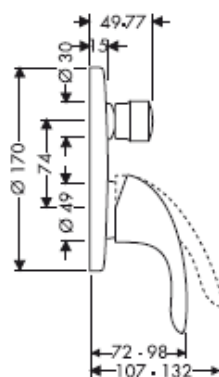
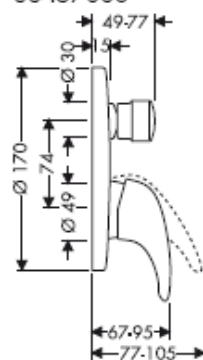
**Talis E**33455000/
33457000**Metropol E**

14675XXX

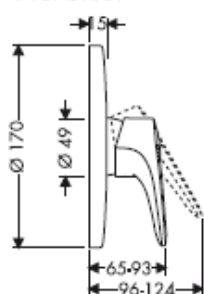
**Metris E**

31675000

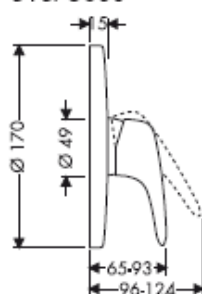
**Focus E**

31761000

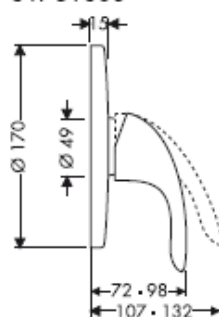
**Talis E**

33655000

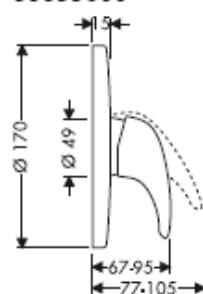

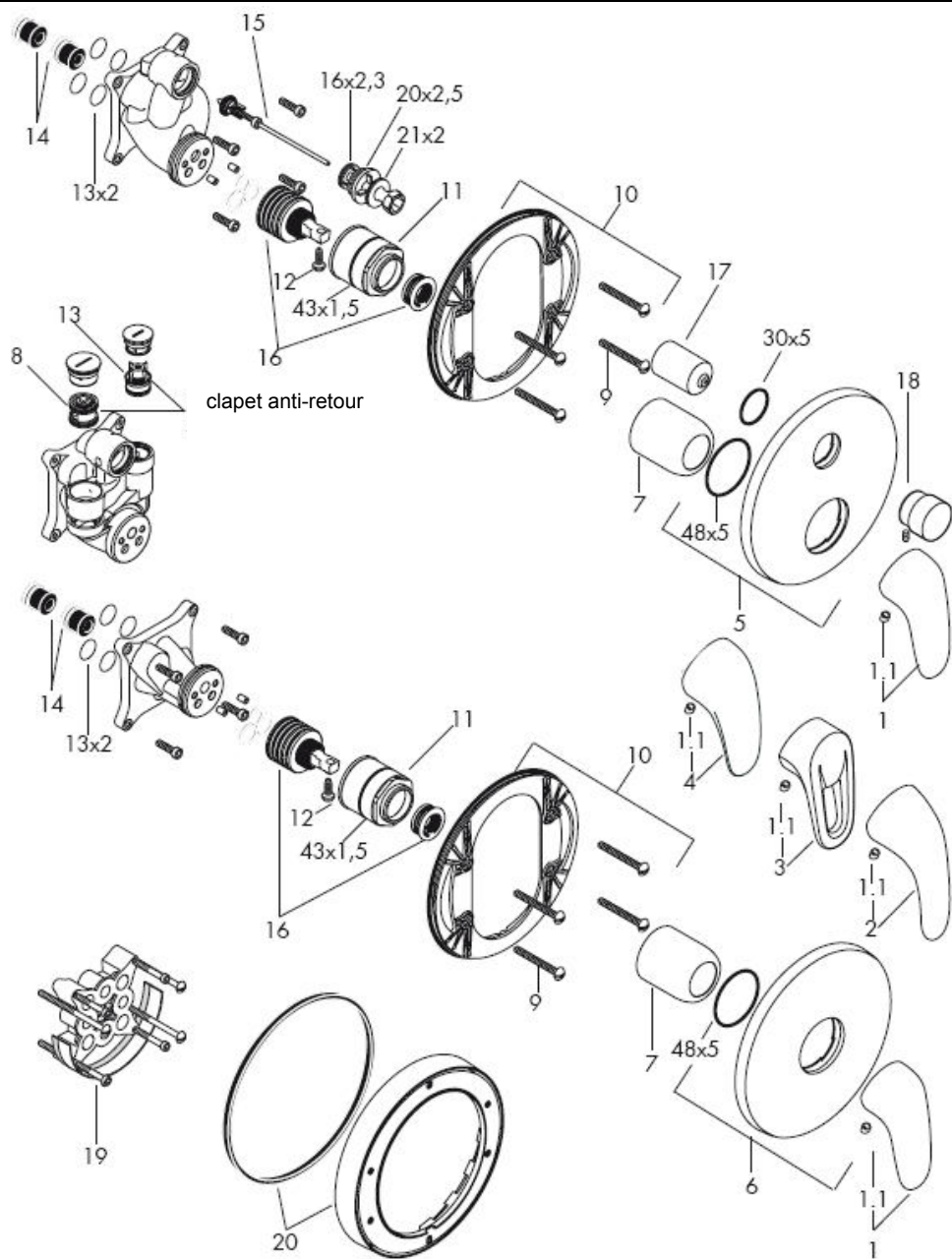

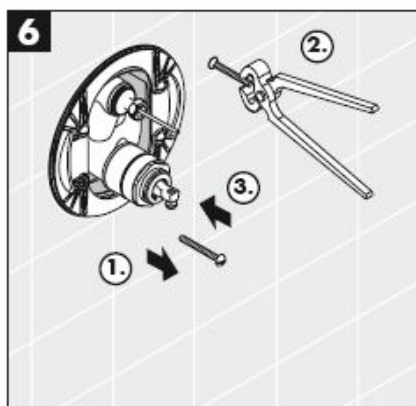
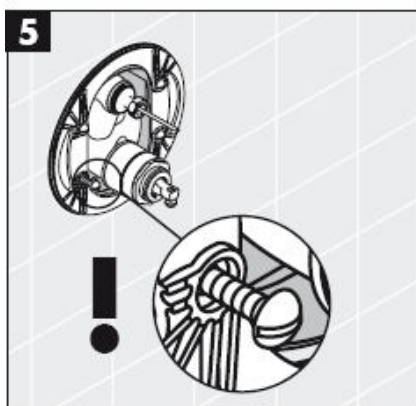
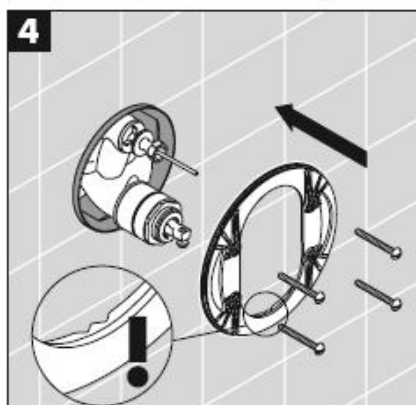
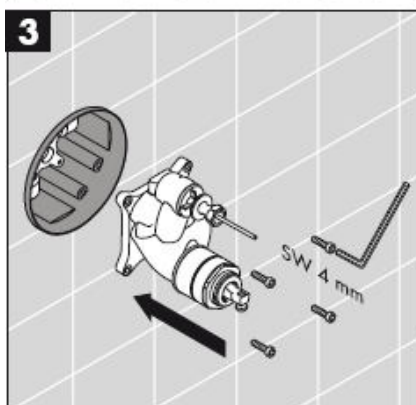
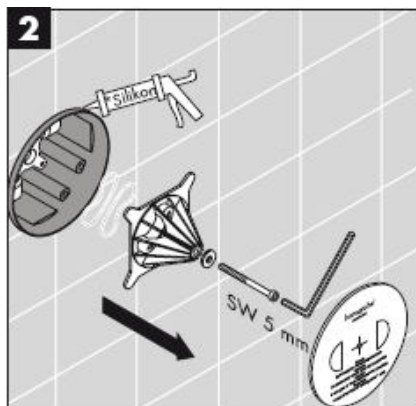
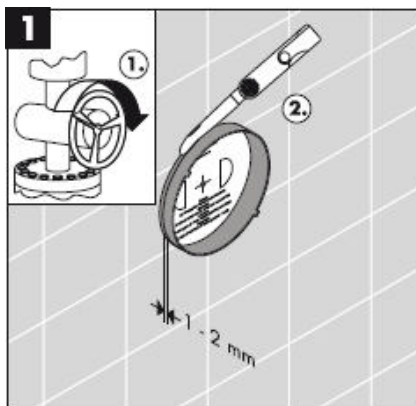

*Silicone (sans acide acétique!)

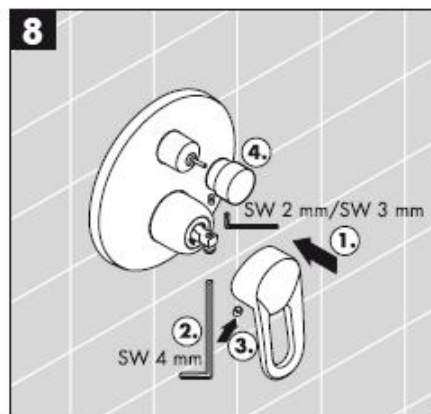
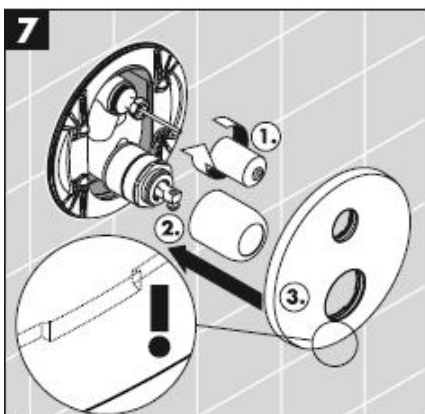

Montage

Attention! La robinetterie doit être installée, rincée et contrôlée conformément aux normes valables!

Instructions de service

En levant ou en baissant l'étrier de commande on actionne l'ouverture ou la fermeture du mitigeur.

En tournant sur la droite = eau froide, en tournant sur la gauche = eau chaude.

Pour l'inversion en douchette tirer le bouton au-dessus de l'étrier. L'inverseur revient automatiquement après la fermeture de l'eau.

Informations techniques

Pression de service autorisée:	max. 1 MPa
Pression de service conseillée:	0,1 – 0,5 MPa
Pression maximum de contrôle:	1,6 MPa
(1 MPa = 10 bars = 147 PSI)	
Température max. d'eau chaude:	max. 80° C
Température recommandée:	65° C
Débit: 0,3 MPa	
14475XXX / 14477XXX /	
31475000 / 31476000 /	
31744000 / 33455000 / 33457000:	
Sortie Baignoire	ca. 30 l/min
Sortie Douche	ca. 24 l/min
14675XXX / 31675000 /	
31761000 / 33665000:	ca. 32 l/min
Avec dispositif anti-retour:	
	14477XXX
	31476000
	33457000

Les mitigeurs monocommandes Hansgrohe fonctionnent également en association à des chauffe-eau à commande hydraulique ou thermique à condition que la pression soit au minimum de 0,15 MPa.

Mitigeur avec limitation de la température: consulter la page 8 pour le réglage
Une limitation de la température n'est pas nécessaire quand le mitigeur est alimenté par un chauffe-eau instantané.

Ne pas monter d'arrêt d'eau chaude avec un raccordement à un chauffe-eau instantané.

Parce que l'eau pourrait fuir de l'ibox en cas de défaillance des pièces de fonctionnement, l'ibox doit être monté au dessus de la baignoire pour que la fuite puisse s'écouler dans la baignoire.

Les dispositifs de sécurité des robinetteries 14477XXX/31476000/33457000 doivent être vérifiés une fois par an quant à leur fonctionnement.

Les clapets anti-retour doivent être examinés régulièrement conformément à la norme EN 1717 ou conformément aux dispositions nationales ou régionales quant à leur fonction (au moins une fois par an).

Pièces détachées voir pages 3

1	poignée Metris E	31094XXX
1.1	cache vis	96338000
2	poignée Focus E	31791000
3	handle Metropol E	14094XXX
4	poignéeTalis E	33091000
5	rosace	96453XXX
6	rosace	96452XXX
7	rosace E	95010XXX
8	disconnecteur	96753000
9	vis du support (4)	96454000
10	support de rosace	96447000
11	écrou	95007000
12	vis	96059000
13	clapet anti-retour	96655000
14	silencieux	94073000
15	inverseur cpl.	95014000
16	cartouche cpl.	92730000
17	douille d'inverseur	96448000
18	bouton d'inverseur	95013XXX
19	jeu de rallonge 25 mm	13595000
20	jeu de rallonge 22 mm	13596000

XXX = Couleurs

000 chromé
090 chromé/or

Classification acoustique et débit

	DVGW	P-IX	SVGW	NF	WRAS	KIWA
14475XXX	X	PA-IX 9709/ICC	X		X	
14477XXX		PA-IX 18097/IDC				
14675XXX	X	PA-IX 9710/IB	X		X	
31475000	X	PA-IX 9709/ICC	X		X	
31476000		PA-IX 18097/IDC				
31675000	X	PA-IX 9710/IB	X			
31744000	X	PA-IX 9709/IDC	X			
31761000	X	PA-IX 9710/IB	X		X	
33455000	X	PA-IX 9709/IDC	X	X	X	X
33457000	X	PA-IX 18097/IDC	X	X		
33655000	X	PA-IX 9710/IB	X	X		X

Dysfonctionnement	Origine	Solution
Dureté de fonctionnement	-Cartouche défectueuse, entartée	-Changer le cartouche
Le mitigeur goutte	-Cartouche défectueuse, entartée	-Changer le cartouche
L'inverseur ne fonctionne pas	-Pression d'alimentation insuffisante -Inverseur défectueux	-Augmenter la pression d'alimentation -Changez l'inverseur
Température d'eau chaude trop basse, pas d'eau froide Le chauffe eau instantané met en route quand on puise de l'eau froide.	-Limiteur de température mal positionné -Flux inversé	-Positionner le limiteur de température -Changer le cartouche

Limiteur d'eau chaude: Température d'eau chaude 60 C, Température d'eau froide 10 C, Pression dynamique 0,3 MPa.

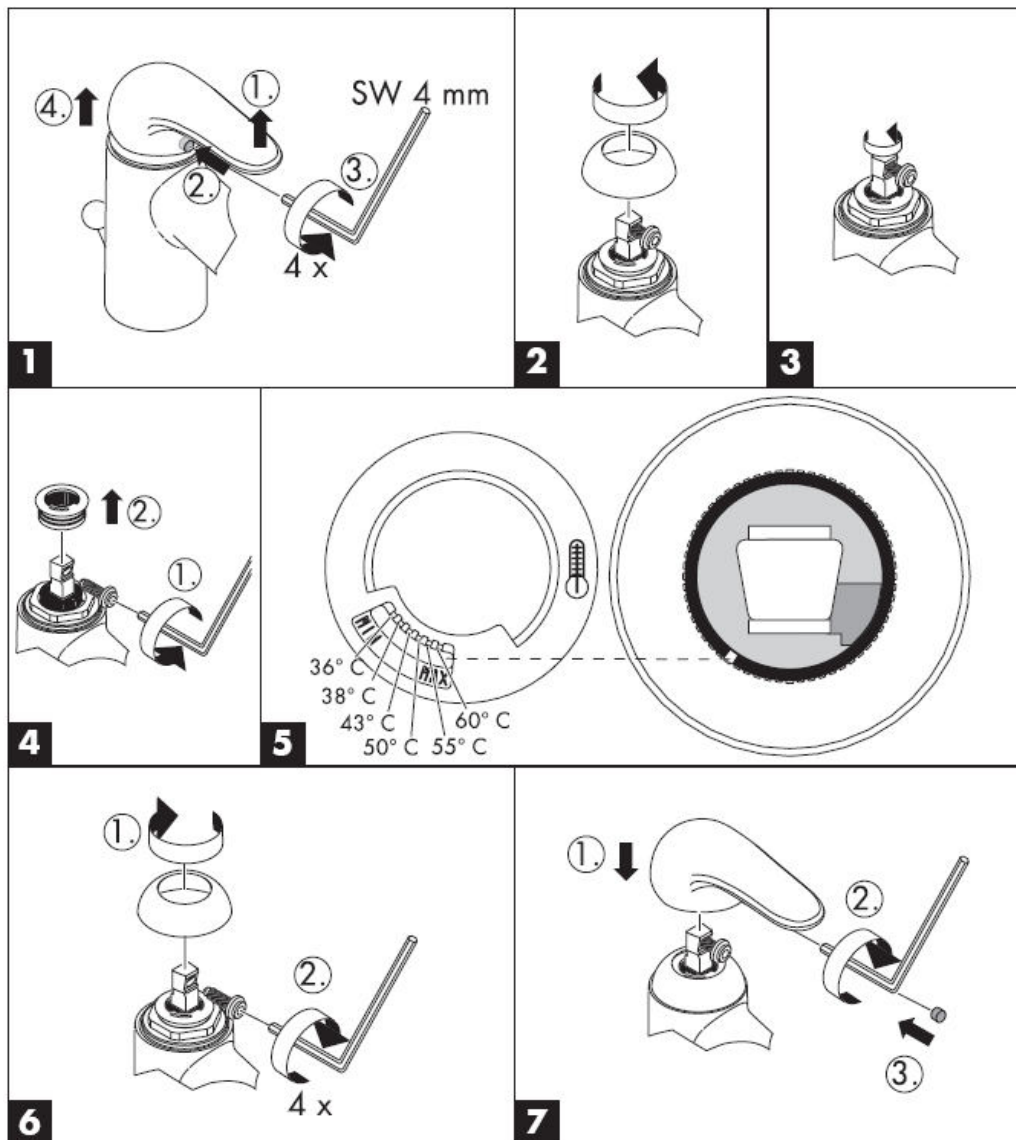

assembly instructions



Metropol E
14475XXX/
14477XXX



Metris E
31475000/
31476000



Focus E
31744000



Talis E
33455000/
33457000



Metropol E
14675XXX



Metris E
31675000



Focus E
31761000



Talis E
33655000

hansgrohe

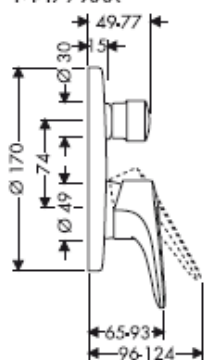
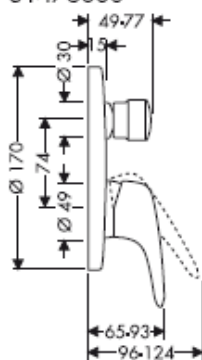
Metropol E14475XXX/
14477XXX**Metris E**31475000/
31476000**Focus E**

31744000

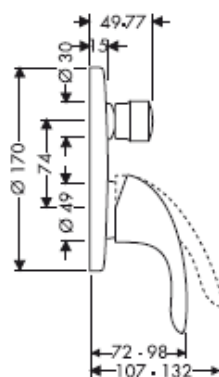
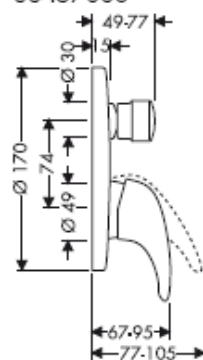
**Talis E**33455000/
33457000**Metropol E**

14675XXX

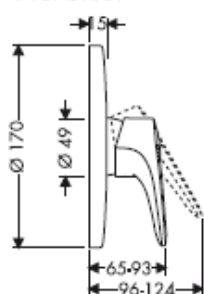
**Metris E**

31675000

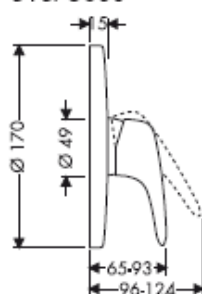
**Focus E**

31761000

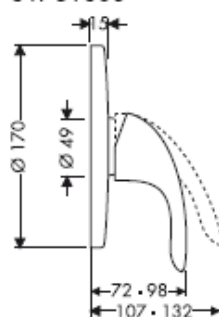
**Talis E**

33655000

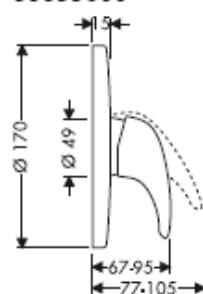

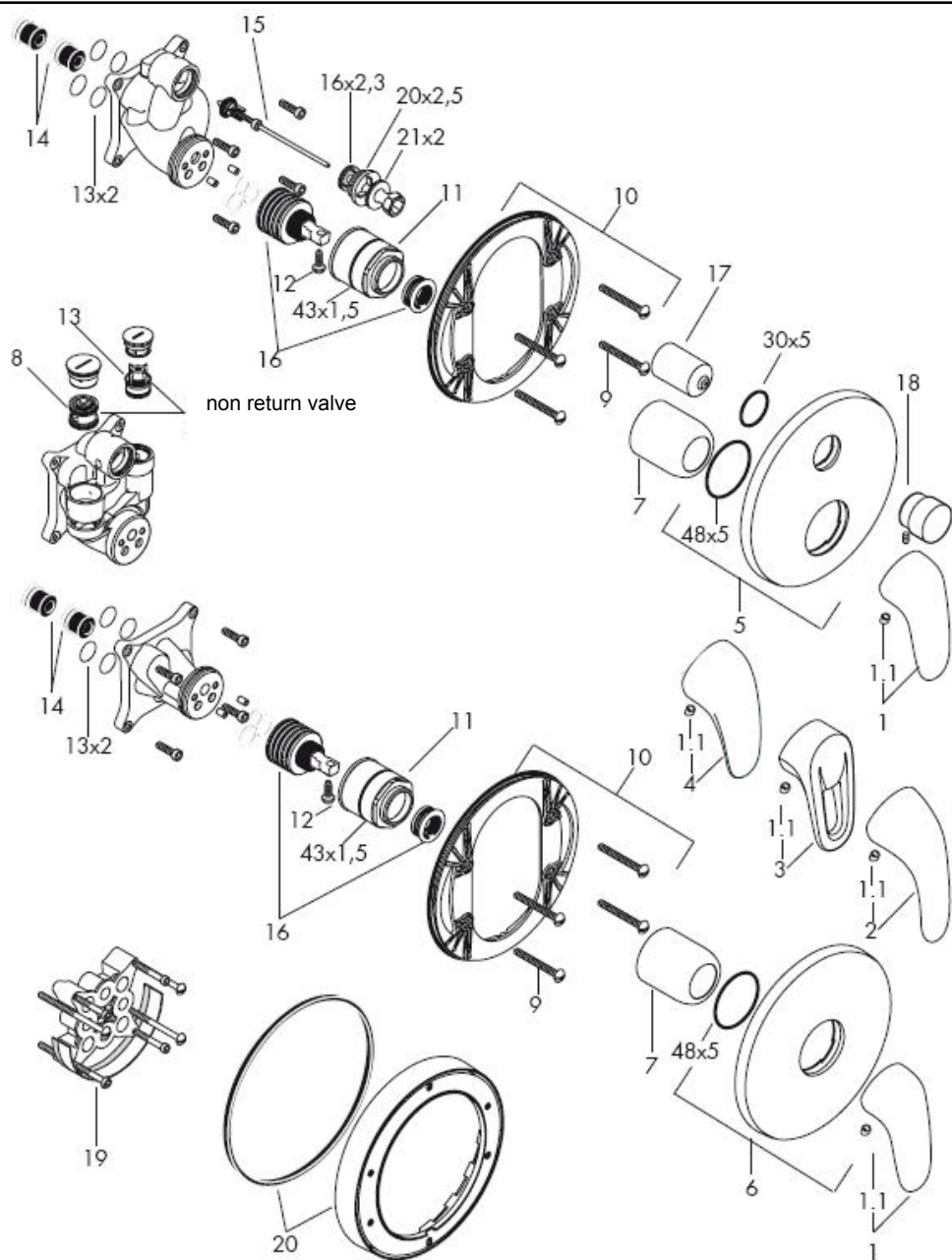

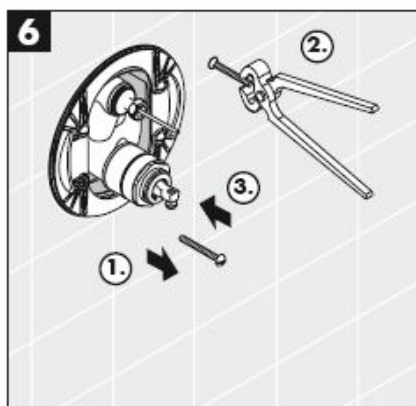
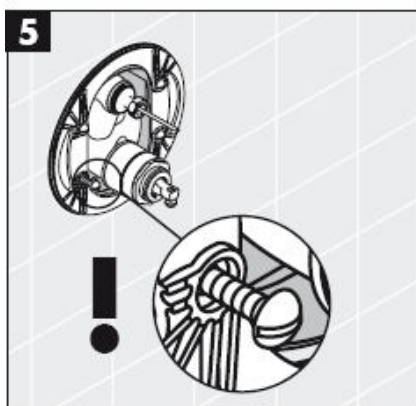
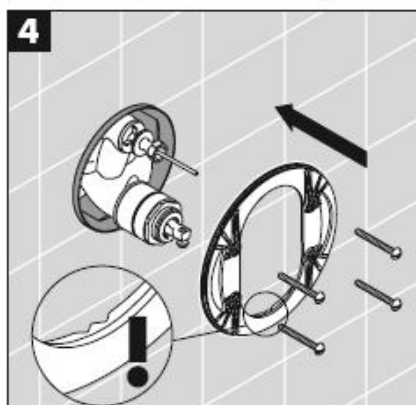
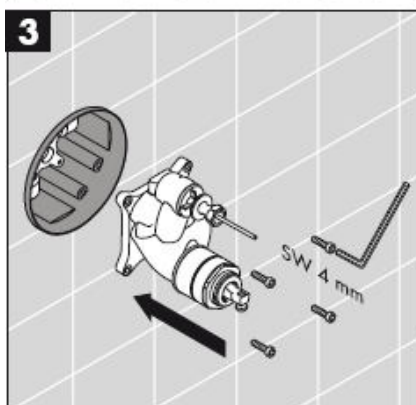
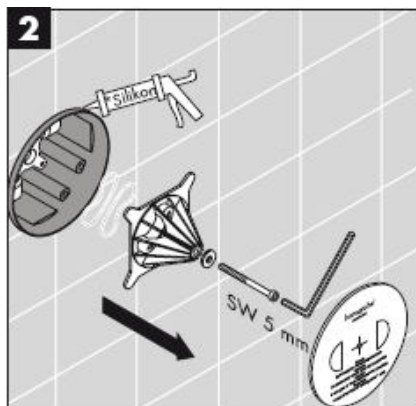
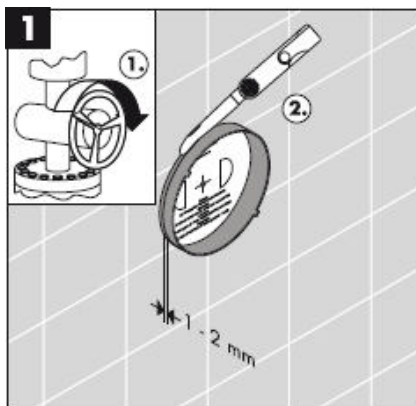

*Silicone (free from acetic acid!)

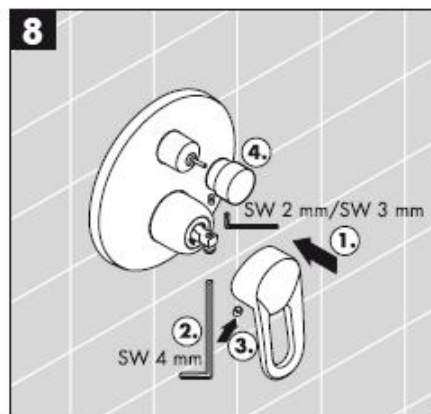
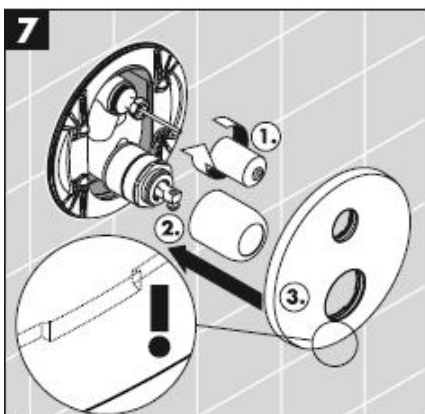

Assembly

Important! The fitting must be installed, flushed and tested after the valid norms!

Operation

The mixer is activated by pulling the lever handle.

Move to the left = hot water, move to the right = cold water.

The flow is changed from bath to shower function by pulling the knob at the upper side of the spout. After shutting off the water flow, the mixer returns automatically to the bath function.

Technical Data

Operating pressure:	max. 1 MPa
Recommended operating pressure:	0,1 – 0,5 MPa
Test pressure:	1,6 MPa
(1 MPa = 10 bars = 147 PSI)	
Hot water temperature:	max. 80° C
Recommended hot water temp.:	65° C
Rate of flow: 0,3 MPa	
14475XXX / 14477XXX /	
31475000 / 31476000 /	
31744000 / 33455000 / 33457000:	
Outlet Bath tub	ca. 30 l/min
Outlet Shower	ca. 24 l/min
14675XXX / 31675000 /	
31761000 / 33665000:	ca. 32 l/min
anti-pollution function:	14477XXX
	31476000
	33457000

Hansgrohe single lever mixers can be used together with hydraulically and thermally controlled continuous flow heaters if the flow pressure is at least 0,15 MPa.

To adjust the hot water limiter on single lever mixers, please see page 8.

No adjustment is necessary when using a continuous flow water heater.

Don't install a hot-water-barrier in combination with flow-heater!

Install the ibox always above the bath-tup. If parts of the ibox will broken, the water can flow in there!

The safety device of 14477XXX/31476000/33457000 must be checked once a year.

The non return valves must be checked regularly according to DIN EN 1717 in accordance with national or regional regulations (at least once a year).

Spare parts see page 3

1	handle Metris E	31094XXX
1.1	screw cover	96338000
2	handle Focus E	31791000
3	handle Metropol E	14094XXX
4	handle Talis E	33091000
5	flange	96453XXX
6	flange	96452XXX
7	flange E	95010XXX
8	vacuum breaker	96753000
9	fixing screw (4)	96454000
10	sub plate	96447000
11	nut	95007000
12	locking screw for handle	96059000
13	non return valve	96655000
14	noise reduction	94073000
15	selector assy	95014000
16	cartridge cpl.	92730000
17	sleeve	96448000
18	diverter knob	95013XXX
19	extension 25 mm	13595000
20	extension 22 mm	13596000

XXX = Colors

000 chrome plated
090 chrome plated/gold plated

Test certificate

	DVGW	P-IX	SVGW	NF	WRAS	KIWA
14475XXX	X	PA-IX 9709/ICC	X		X	
14477XXX		PA-IX 18097/IDC				
14675XXX	X	PA-IX 9710/IB	X		X	
31475000	X	PA-IX 9709/ICC	X		X	
31476000		PA-IX 18097/IDC				
31675000	X	PA-IX 9710/IB	X			
31744000	X	PA-IX 9709/IDC	X			
31761000	X	PA-IX 9710/IB	X		X	
33455000	X	PA-IX 9709/IDC	X	X	X	X
33457000	X	PA-IX 18097/IDC	X	X		
33655000	X	PA-IX 9710/IB	X	X		X

Fault	Cause	Remedy
Mixer stiff	-Cartridge defective, calcified	-Exchange cartridge
Mixer dripping	-Cartridge defective, sedimentation	-Exchange cartridge
Diverter not operating	-Water pressure too low -Diverter defective	-Increase water pressure -Exchange diverter
Hot water temperature too low, no cold water.	-Hot water limiter incorrectly set	-Set hot water limiter
Instantaneous water heater starts up when cold water is selected.	-Crossflow	-Exchange cartridge

Hot water limiter: hot water temperature 60 C, cold water temperature 10 C, flow rate 0,3 MPa.

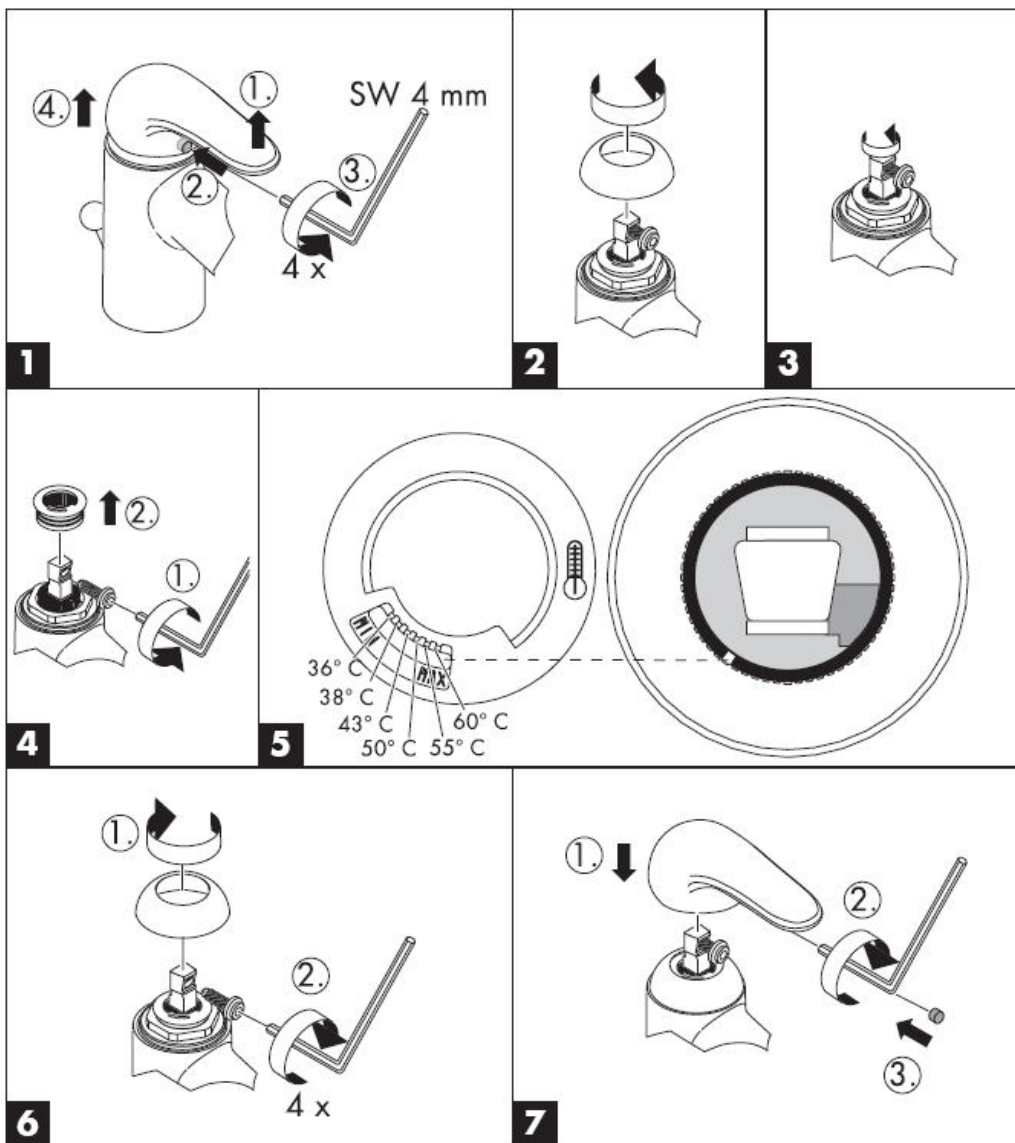

Istruzioni per Installazione



Metropol E
14475XXX/
14477XXX



Metris E
31475000/
31476000



Focus E
31744000



Talis E
33455000/
33457000



Metropol E
14675XXX



Metris E
31675000



Focus E
31761000



Talis E
33655000

hansgrohe

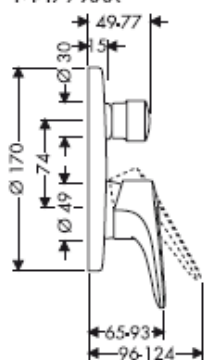
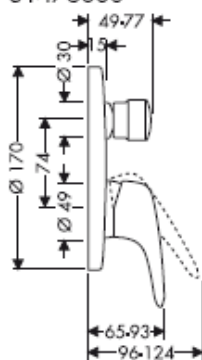
Metropol E14475XXX/
14477XXX**Metris E**31475000/
31476000**Focus E**

31744000

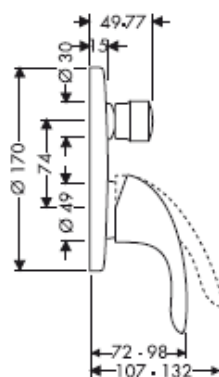
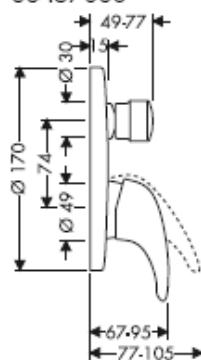
**Talis E**33455000/
33457000**Metropol E**

14675XXX

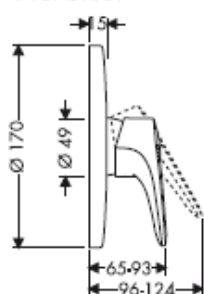
**Metris E**

31675000

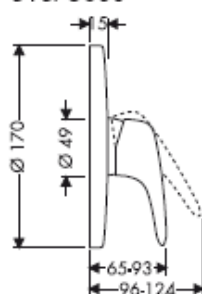
**Focus E**

31761000

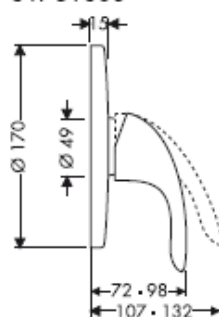
**Talis E**

33655000

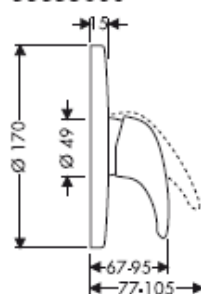

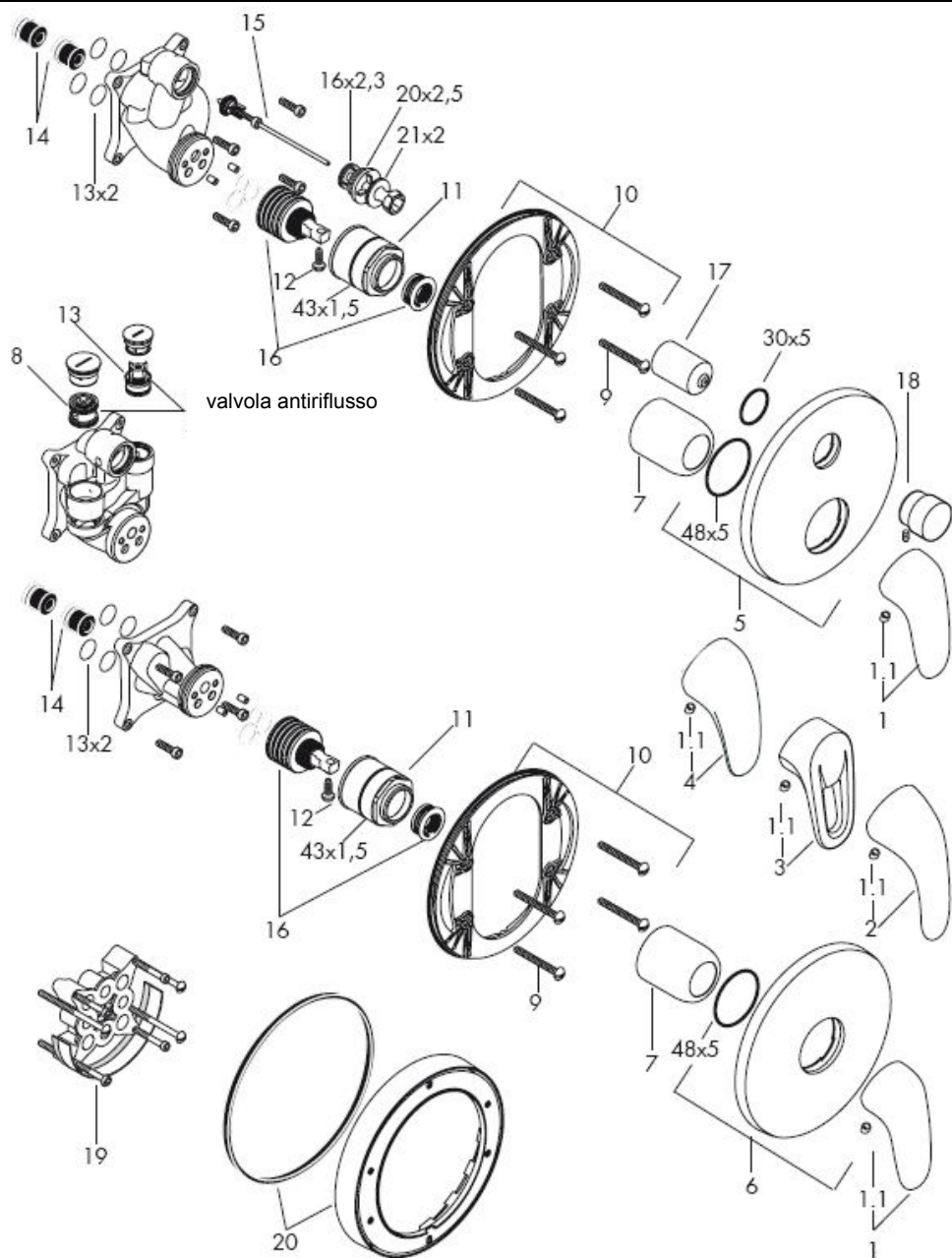

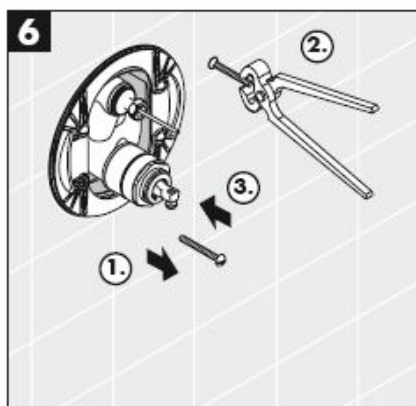
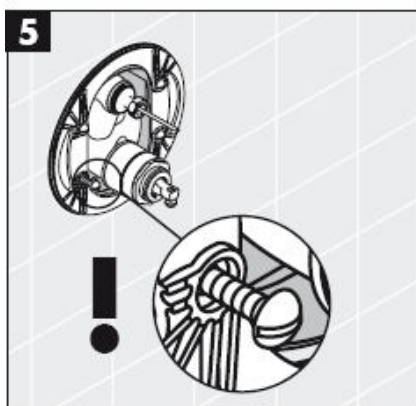
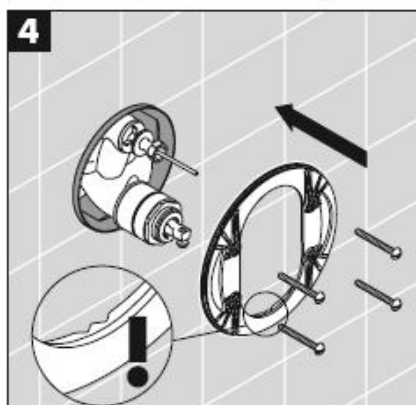
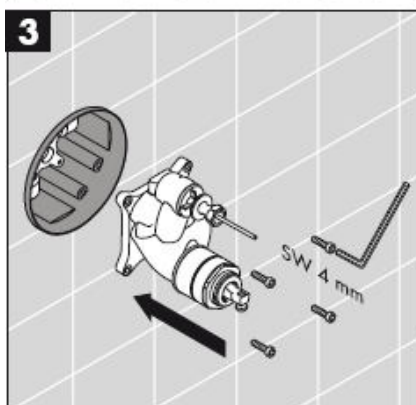
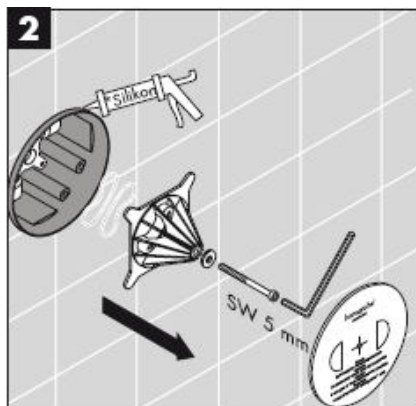
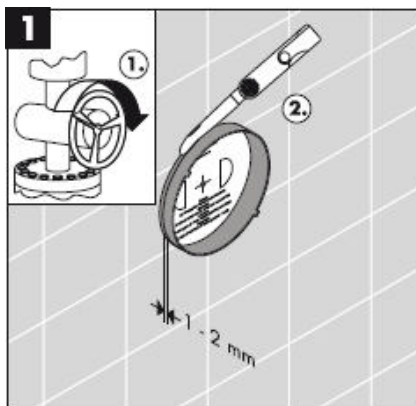

*Silicone (esente da acido acetico!)

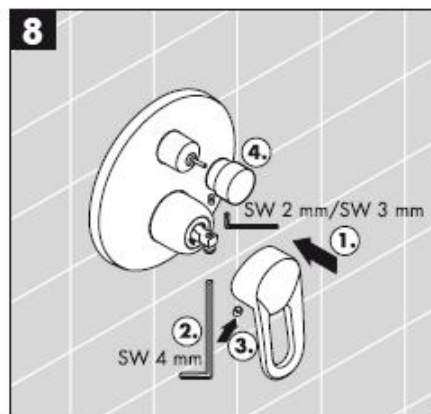
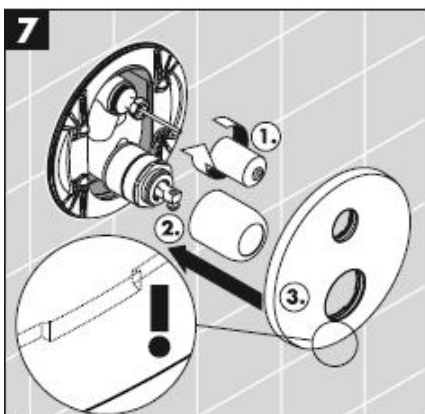

Montaggio

Attenzione! La rubinetteria deve essere installata, pulita e testata secondo le istruzioni riportate!

Procedura

Il miscelatore si apre tirando la maniglia a forma di staffa.
 Rotazione verso sinistra = acqua calda, rotazione verso destra = acqua fredda.
 Commutazione alla doccetta tirando il rispettivo pomello. Il ritorno avviene automaticamente chiudendo la manopola.

Dati tecnici

Pressione d'uso:	max. 1 MPa
Pressione d'uso consigliata:	0,1 – 0,5 MPa
Pressione di prova:	1,6 MPa
(1 MPa = 10 bar = 147 PSI)	
Temperatura dell'acqua calda:	max. 80° C
Temp. dell'acqua calda consigliata:	65° C
Portata di erogazione: 0,3 MPa	
14475XXX / 14477XXX /	
31475000 / 31476000 /	
31744000 / 33455000 / 33457000:	
Uscita Vasca	ca. 30 l/min
Uscita doccetta	ca. 24 l/min
14675XXX / 31675000 /	
31761000 / 33665000:	ca. 32 l/min
Sicurezza antiriflusso:	14477XXX
	31476000
	33457000

I miscelatori Hansgrohe possono venire usati con caldaie a "bassa pressione" se la pressione del flusso è almeno di 0,15 MPa.

Regolazione del limitatore di erogazione di acqua calde dei miscelatori monocomando, vedere pagina 8.

In combinazione con le caldaie istantanee, il limitatore di erogazione di acqua calda non è necessario.

Non installare alcuna valvola antiriflusso sull'adduzione dell'acqua calda.

Installare sempre l'ibox sopra alla vasca o al piatto doccia, poiché in caso di fuoriuscita d'acqua questa verrà convogliata allo scarico.

I dispositivi di sicurezza delle rubinetterie 14477XXX/31476000/33457000 vanno controllati sulla loro funzione una volta l'anno.

La valvola di non ritorno deve essere controllata regolarmente come da DIN EN 1717, secondo le normative nazionali e regionali (almeno una volta all'anno).

Parti di ricambio vedi pagg. 3

1	maniglia Metris E	31094XXX
1.1	tappino	96338000
2	maniglia Focus E	31791000
3	maniglia Metropol E	14094XXX
4	manigliaTalis E	33091000
5	copertura	96453XXX
6	copertura	96452XXX
7	cappuccio E	95010XXX
8	valvola antiriflusso	96753000
9	vite portante (4)	96454000
10	copertura portante	96447000
11	ghiera di fissaggio	95007000
12	avvitare di sicurezza	96059000
13	valvola antiriflusso	96655000
14	sorbente acustico	94073000
15	deviatore completo	95014000
16	cartuccia completa	92730000
17	cappuccio	96448000
18	pomello deviatore	95013XXX
19	prolunga 25 mm	13595000
20	prolunga 22 mm	13596000

XXX = Trattamento

000 cromato
 090 cromato/oro

Segno di verifica

	DVGW	P-IX	SVGW	NF	WRAS	KIWA
14475XXX	X	PA-IX 9709/ICC	X		X	
14477XXX		PA-IX 18097/IDC				
14675XXX	X	PA-IX 9710/IB	X		X	
31475000	X	PA-IX 9709/ICC	X		X	
31476000		PA-IX 18097/IDC				
31675000	X	PA-IX 9710/IB	X			
31744000	X	PA-IX 9709/IDC	X			
31761000	X	PA-IX 9710/IB	X		X	
33455000	X	PA-IX 9709/IDC	X	X	X	X
33457000	X	PA-IX 18097/IDC	X	X		
33655000	X	PA-IX 9710/IB	X	X		X

Problema	Possibile causa	Rimedio
Miscelatore duro	-Cartuccia difettosa	-Sostituire la cartuccia
Miscelatore gocciola	-cartuccia difettosa	-Sostituire la cartuccia
Deviatore non funziona	-pressione d'acqua troppo bassa -deviatore difettoso	-alzare la pressione d'acqua -sostituire deviatore
Temperatura dell'acqua calda troppo bassa, niente acqua fredda, caldaia istantanea si accende quando si seleziona acqua fredda	-Limitazione dell'acqua calda regolata male -Flusso incrociato	-Regolare la limitazione dell'acqua calda -Sostituire la cartuccia

Limitatore di acqua calda: temperatura dell'acqua calda 60 C, temperatura dell'acqua fredda 10 C, pressione 0,3 MPa.

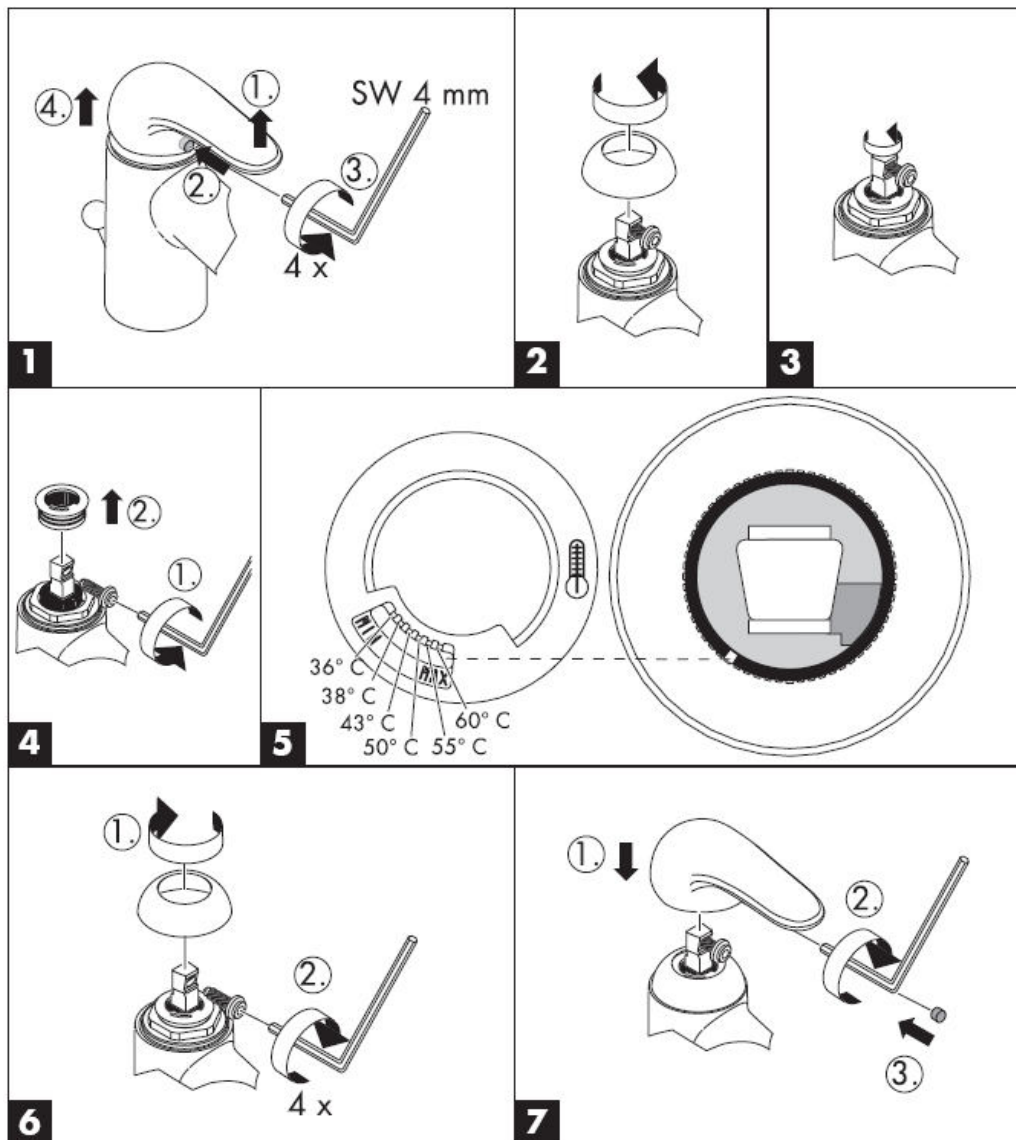

Instrucciones de montaje



Metropol E
14475XXX/
14477XXX



Metris E
31475000/
31476000



Focus E
31744000



Talis E
33455000/
33457000



Metropol E
14675XXX



Metris E
31675000



Focus E
31761000



Talis E
33655000

hansgrohe

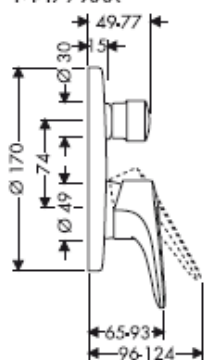
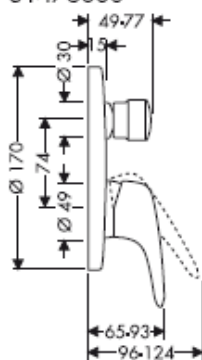
Metropol E14475XXX/
14477XXX**Metris E**31475000/
31476000**Focus E**

31744000

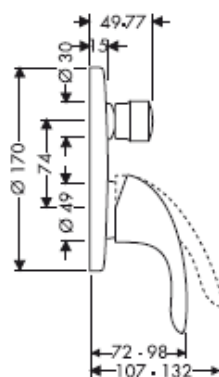
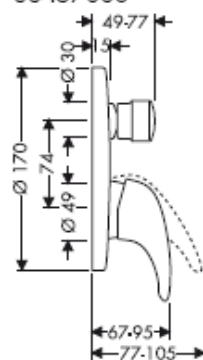
**Talis E**33455000/
33457000**Metropol E**

14675XXX

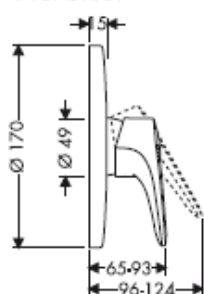
**Metris E**

31675000

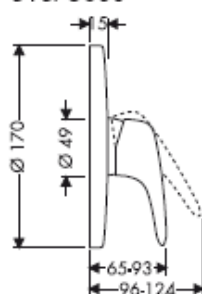
**Focus E**

31761000

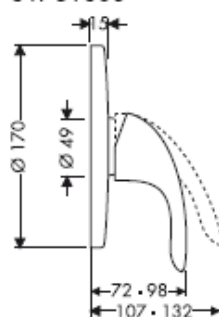
**Talis E**

33655000

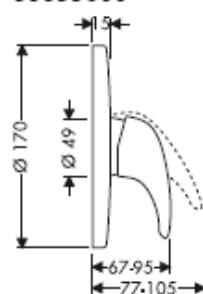

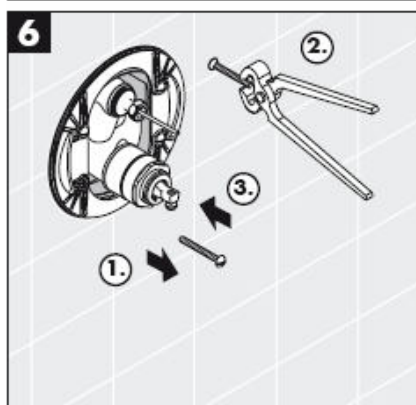
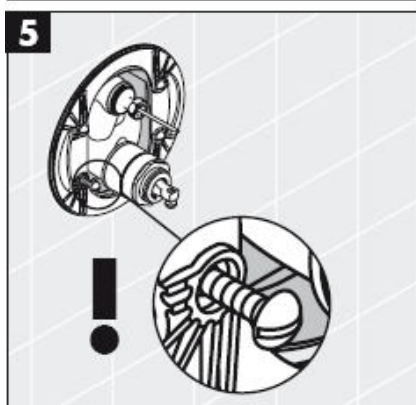
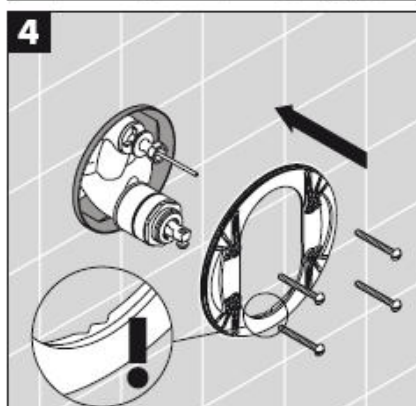
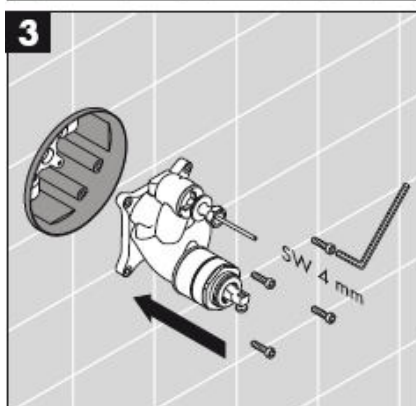
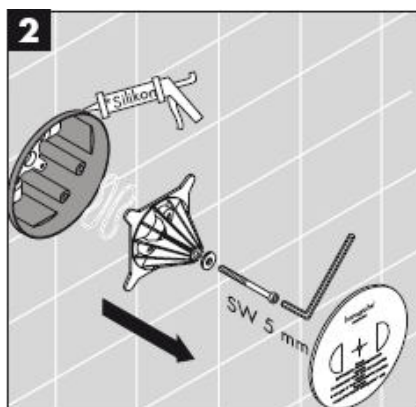
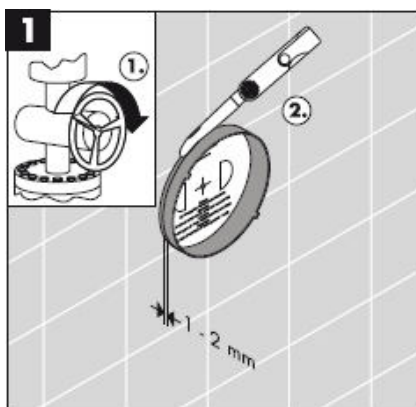

*Silicona (¡libre de ácido acético!)

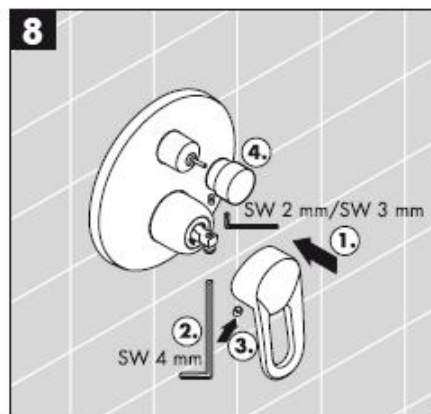
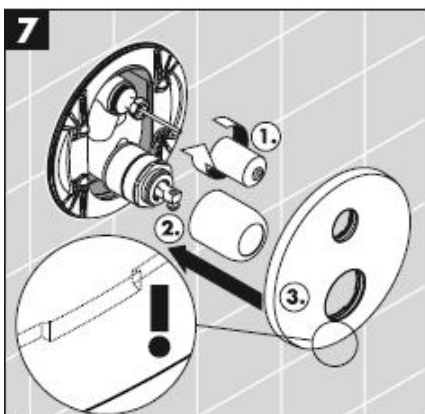

Montaje

¡Atención! El grifo tiene que ser instalado, probado y testado, según las normas en vigor.

Manejo

El mezclador se abre levantando la manecilla. Giro hacia la izquierda = agua caliente, giro hacia la derecha = agua fría. El inversor para la teleducha se activa al tirar del botón cambiador. Al cerrar el mando vuelve automáticamente a su posición inicial.

Datos técnicos

Presión en servicio:	max. 1 MPa
Presión recomendada en servicio:	0,1 – 0,5 MPa
Presión de prueba:	1,6 MPa
(1 MPa = 10 bares = 147 PSI)	
Temperatura del agua caliente:	max. 80° C
Temp. recomendada del agua caliente:	65° C
Caudal máximo: 0,3 MPa	
14475XXX / 14477XXX /	
31475000 / 31476000 /	
31744000 / 33455000 / 33457000:	
Salida Baño	ca. 30 l/min
Salida Ducha	ca. 24 l/min
14675XXX / 31675000 /	
31761000 / 33665000:	ca. 32 l/min
Seguro contra el retorno:	14477XXX
	31476000
	33457000

Los mezcladores Hansgrohe pueden ser utilizado junto con calentadores continuos de agua que sean manejados de manera hidráulica o térmica, siempre que la presión del caudal ascienda a un mínimo de 0,15 MPa.

Mezclador monomando con limitación del caudal de agua caliente; ajuste ver pagina 8. En combinación con calentadores instantáneos no es necesario una limitación del caudal de agua caliente.

No instalar un bloqueador de agua caliente en combinación con un calentador instantáneo.

Instalar el ibox siempre por encima de la bañera ya que, si se rompiera alguna pieza del ibox, el agua estaría contenida.

La correcta función de los dispositivos de seguridad de las griferías 14477XXX/31476000/33457000 se debe comprobar una vez al año.

Las válvulas anti-retorno tienen que ser controladas regularmente según la norma DIN EN 1717, en acuerdo con las regulaciones nacionales o regionales (una vez al año, por lo menos).

Repuestos ver página 3

1	Mando Metris E	31094XXX
1.1	Tapón	96338000
2	Mando Focus E	31791000
3	Mando Metropol E	14094XXX
4	MandoTalis E	33091000
5	Embellecedor	96453XXX
6	Embellecedor	96452XXX
7	Florón E	95010XXX
8	Válvula antirretorno	96753000
9	Tornillo portador (4)	96454000
10	Florón portador	96447000
11	Tuerca	95007000
12	Tornillo	96059000
13	Válvula antirretorno	96655000
14	Silenciador	94073000
15	Inversor	95014000
16	Cartucho completo	92730000
17	Carcasa del inversor	96448000
18	Tirador inversor	95013XXX
19	Prolongación 25 mm	13595000
20	Prolongación 22 mm	13596000

XXX = Acabados

000 cromado
090 cromado/oro

Marca de verificación

	DVGW	P-IX	SVGW	NF	WRAS	KIWA
14475XXX	X	PA-IX 9709/ICC	X		X	
14477XXX		PA-IX 18097/IDC				
14675XXX	X	PA-IX 9710/IB	X		X	
31475000	X	PA-IX 9709/ICC	X		X	
31476000		PA-IX 18097/IDC				
31675000	X	PA-IX 9710/IB	X			
31744000	X	PA-IX 9709/IDC	X			
31761000	X	PA-IX 9710/IB	X		X	
33455000	X	PA-IX 9709/IDC	X	X	X	X
33457000	X	PA-IX 18097/IDC	X	X		
33655000	X	PA-IX 9710/IB	X	X		X

Problema	Causa	Solución
Manecilla va dura	-cartucho dañado	-cambiar el cartucho
Grifo pierde agua	-cartucho calcificado / dañado	-cambiar el cartucho
Inversor no funciona	-falta presión -inversor defecto	-aumentar presión -cambiar inversor
Temperatura del agua demasiado baja no hay agua fría calentador se dispara al abrir agua fría	-tope de agua caliente mal -Flujo cruzado	-ajustar tope -cambiar el cartucho

Limitación del agua caliente: temperatura del agua caliente 60 C, temperatura del agua fría 10 C, presión dinámica 0,3 MPa.

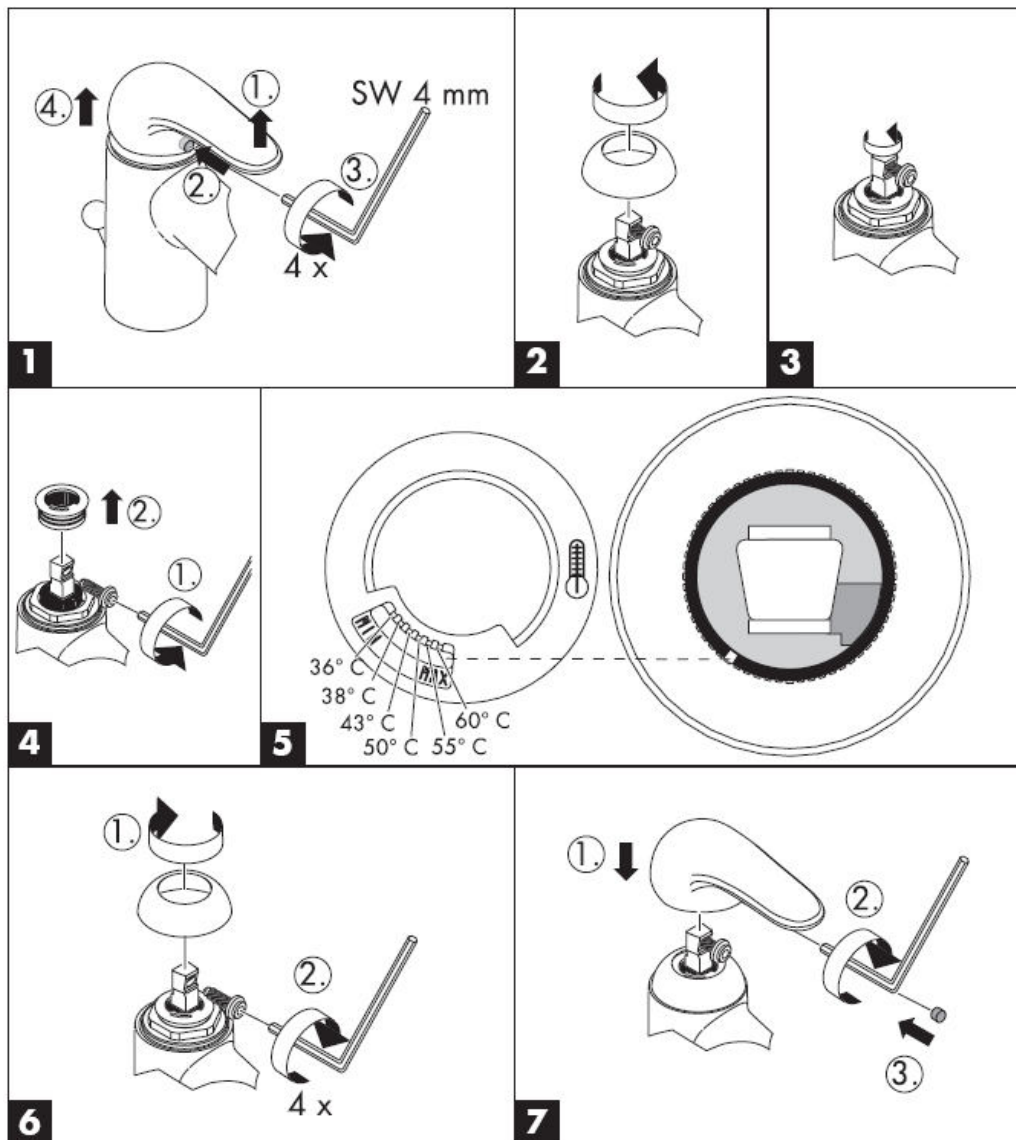

Handleiding



Metropol E
14475XXX/
14477XXX



Metris E
31475000/
31476000



Focus E
31744000



Talis E
33455000/
33457000



Metropol E
14675XXX



Metris E
31675000



Focus E
31761000



Talis E
33655000

hangrohe

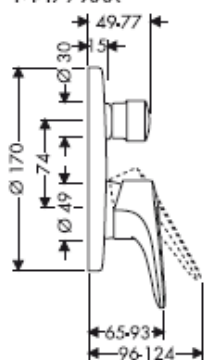
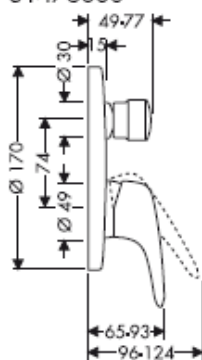
Metropol E14475XXX/
14477XXX**Metris E**31475000/
31476000**Focus E**

31744000

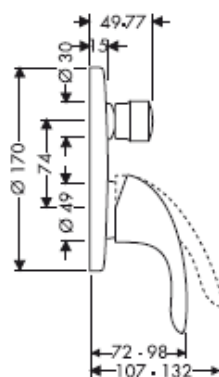
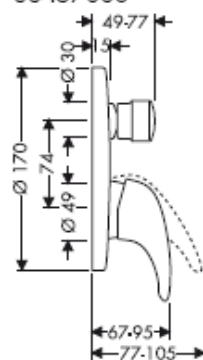
**Talis E**33455000/
33457000**Metropol E**

14675XXX

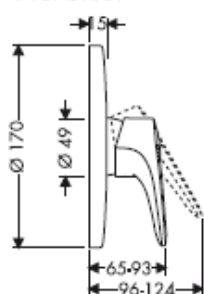
**Metris E**

31675000

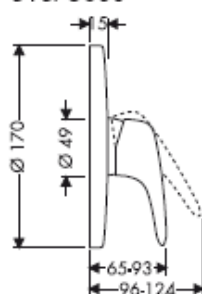
**Focus E**

31761000

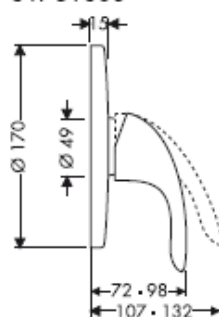
**Talis E**

33655000

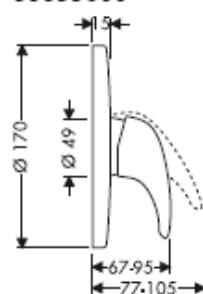

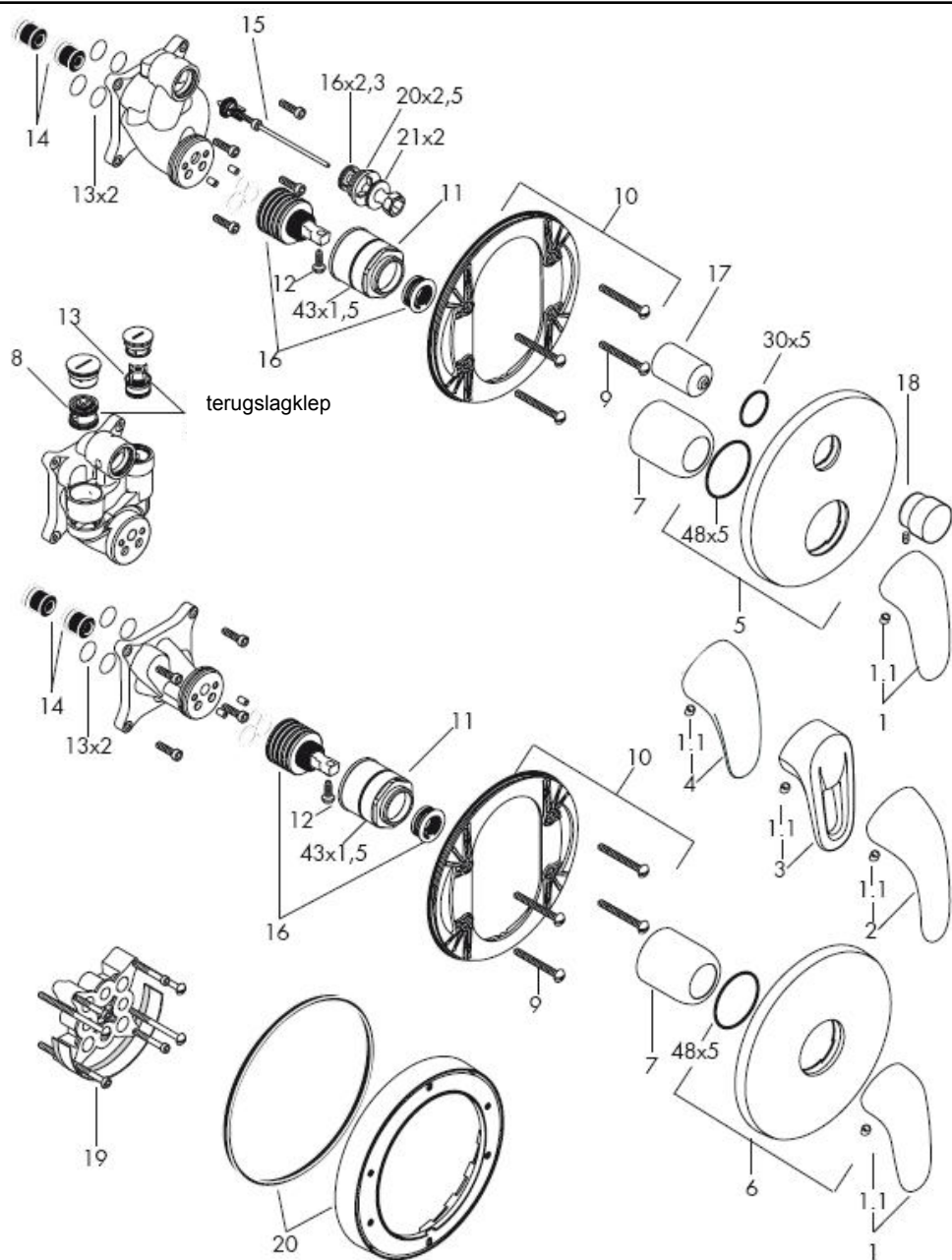

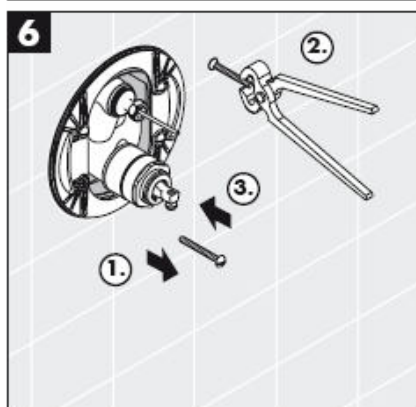
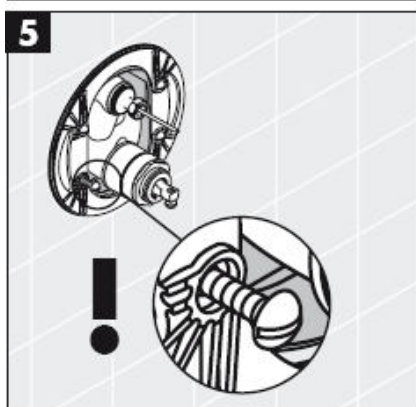
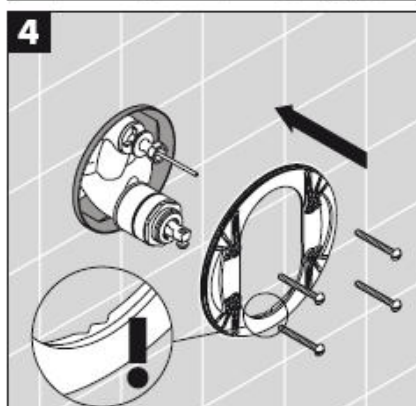
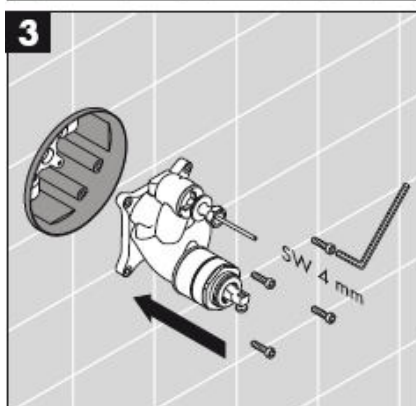
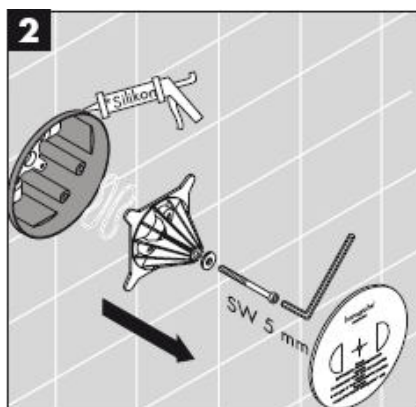
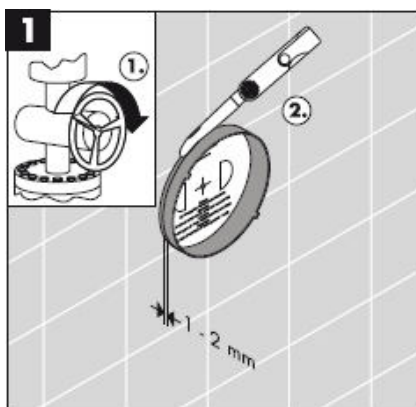

*Silicone (azijnzuurvrij!)

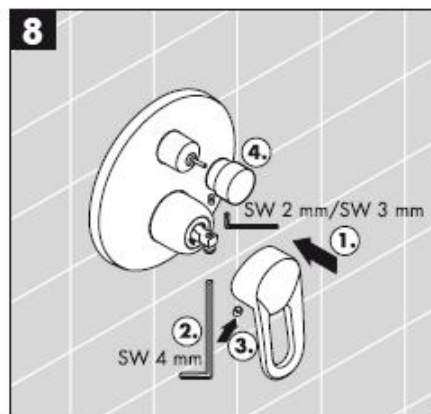
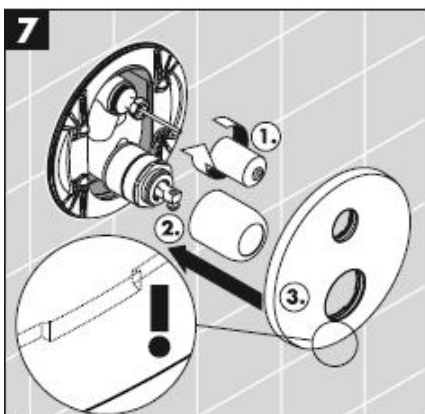

Montage

Attentie! Leidingen doorspoelen volgens Norm. De mengkraan vervolgens monteren en controleren!

Bediening

Door het bedienen van de beugelgreep wordt de mengkraan geopend.

Giro hacia la izquierda = agua caliente, giro hacia la derecha = agua fría.

Het omstellen naar de handdouche gebeurt door aan de knop te trekken. Het terugstellen gebeurt automatisch na het sluiten van de greep.

Technische gegevens

Werkdruk: max.	max. 1 MPa
Aanbevolen werkdruk:	0,1 – 0,5 MPa
Getest bij:	1,6 MPa
(1 MPa = 10 bar = 147 PSI)	
Temperatuur warm water:	max. 80° C
Aanbevolen warm water temp.:	65° C
Doorstroomcapaciteit: 0,3 MPa	
14475XXX / 14477XXX /	
31475000 / 31476000 /	
31744000 / 33455000 / 33457000:	
Uitgang Bad	ca. 30 l/min
Uitgang Douche	ca. 24 l/min
14675XXX / 31675000 /	
31761000 / 33665000:	ca. 32 l/min
Beveiligd tegen terugstromen:	14477XXX
	31476000
	33457000

Hansgrohe ééngreepsmengkranen kunnen samen met hydraulisch en thermisch gestuurde geisers gebruikt worden indien de uitstroomdruk min. 0,15 MPa bedraagt.

Eéngreepsmengkranen met warmwaterbegrenzing, instelling zie blz. 8. In combinatie met geisers is een warmwaterbegrenzing niet noodzakelijk.

In combinatie met doorstroomtoestellen mag geen warm water afsluiter geplaatst zijn.

Bij een defect functiedeel kan mogelijkere wijs water uit de ibox weglopen. Daarom moet de ibox boven het bad gemonteerd worden. Het lekwater wordt dan in het bad afgevoerd!

De veiligheidsinrichtingen van de armaturen 14477XXX/31476000/33457000 moeten jaarlijks gecontroleerd worden op functionaliteit.

Keerklappen moeten volgens DIN EN 1717 regelmatig en volgens plaatselijk geldende eisen op het functioneren gecontroleerd worden. (Tenminste een keer per jaar).

Service onderdelen zie blz. 3

1	greep Metris E	31094XXX
1.1	greepstopje	96338000
2	greep Focus E	31791000
3	greep Metropol E	14094XXX
4	greepTalis E	33091000
5	rozet	96453XXX
6	rozet	96452XXX
7	kogelrozet E	95010XXX
8	beluchter	96753000
9	Drager-schroef (4)	96454000
10	rozetdrager	96447000
11	moer	95007000
12	borgschroef	96059000
13	terugslagklep	96655000
14	slagdemper	94073000
15	omstelling kompl.	95014000
16	kardoes kompl.	92730000
17	omstelhuls	96448000
18	trekknop	95013XXX
19	Verlengstuk 25 mm	13595000
20	Verlengstuk 22 mm	13596000

XXX = Kleuren

000 verchroomd
090 verchroomd/verguld

Nederlands

Keurmerk

	VDGW	P-IX	SVGW	NF	WRAS	KIWA
14475XXX	X	PA-IX 9709/ICC	X		X	
14477XXX		PA-IX 18097/IDC				
14675XXX	X	PA-IX 9710/IB	X		X	
31475000	X	PA-IX 9709/ICC	X		X	
31476000		PA-IX 18097/IDC				
31675000	X	PA-IX 9710/IB	X			
31744000	X	PA-IX 9709/IDC	X			
31761000	X	PA-IX 9710/IB	X		X	
33455000	X	PA-IX 9709/IDC	X	X	X	X
33457000	X	PA-IX 18097/IDC	X	X		
33655000	X	PA-IX 9710/IB	X	X		X

Storing

Oorzaak

Oplossing

bediening zwaar	-Kardoes defect of verkalkt	-Kardoes uitwisselen
Mengkraan lekt	-Kardoes defect of vervuild	-Kardoes uitwisselen
Omstelling functioneert niet	-Waterdruk te laag -Omstelling defect	-Waterdruk verhogen -Omstelling uitwiss
Warmwater temperatuur te laag, geen koud water.	-Heetwaterbegrenzer verkeerd ingesteld	-Heetwaterbegrenzer instellen
Doorstroomtoestel springt aan wanneer koud water gekozen is.	-Kruisstroom	-Kardoes uitwisselen

Warmwaterbegrenzing: Warmwatertemperatuur 60 C, Koudwatertemperatuur 10 C, stroomdruk 0,3 MPa.

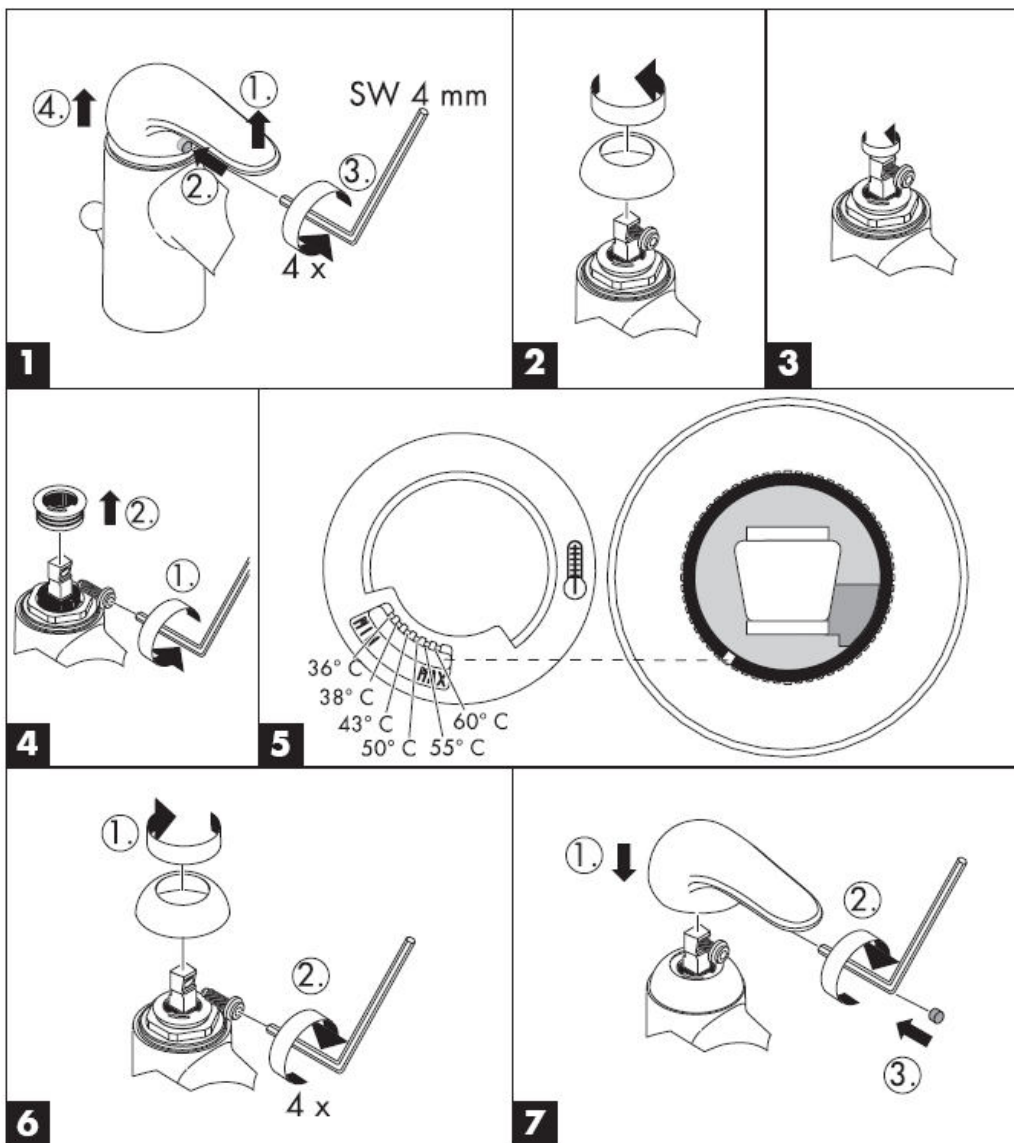

Monteringsvejledning



Metropol E
14475XXX/
14477XXX



Metris E
31475000/
31476000



Focus E
31744000



Talis E
33455000/
33457000



Metropol E
14675XXX



Metris E
31675000



Focus E
31761000



Talis E
33655000

hangrohe

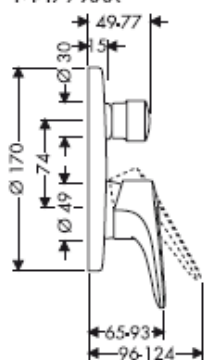
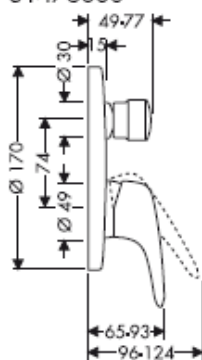
Metropol E14475XXX/
14477XXX**Metris E**31475000/
31476000**Focus E**

31744000

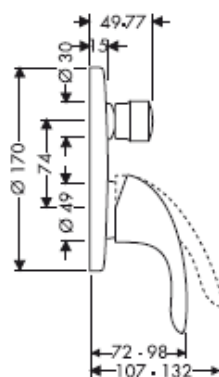
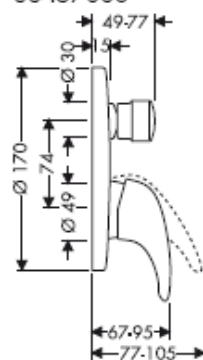
**Talis E**33455000/
33457000**Metropol E**

14675XXX

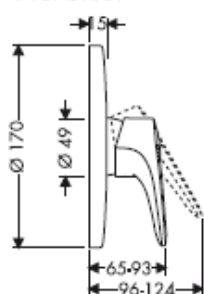
**Metris E**

31675000

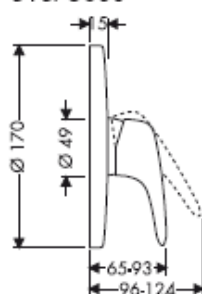
**Focus E**

31761000

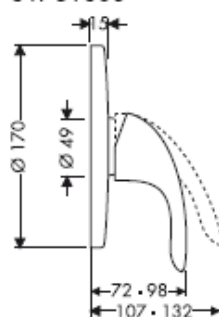
**Talis E**

33655000

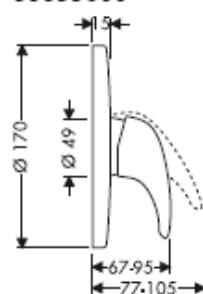

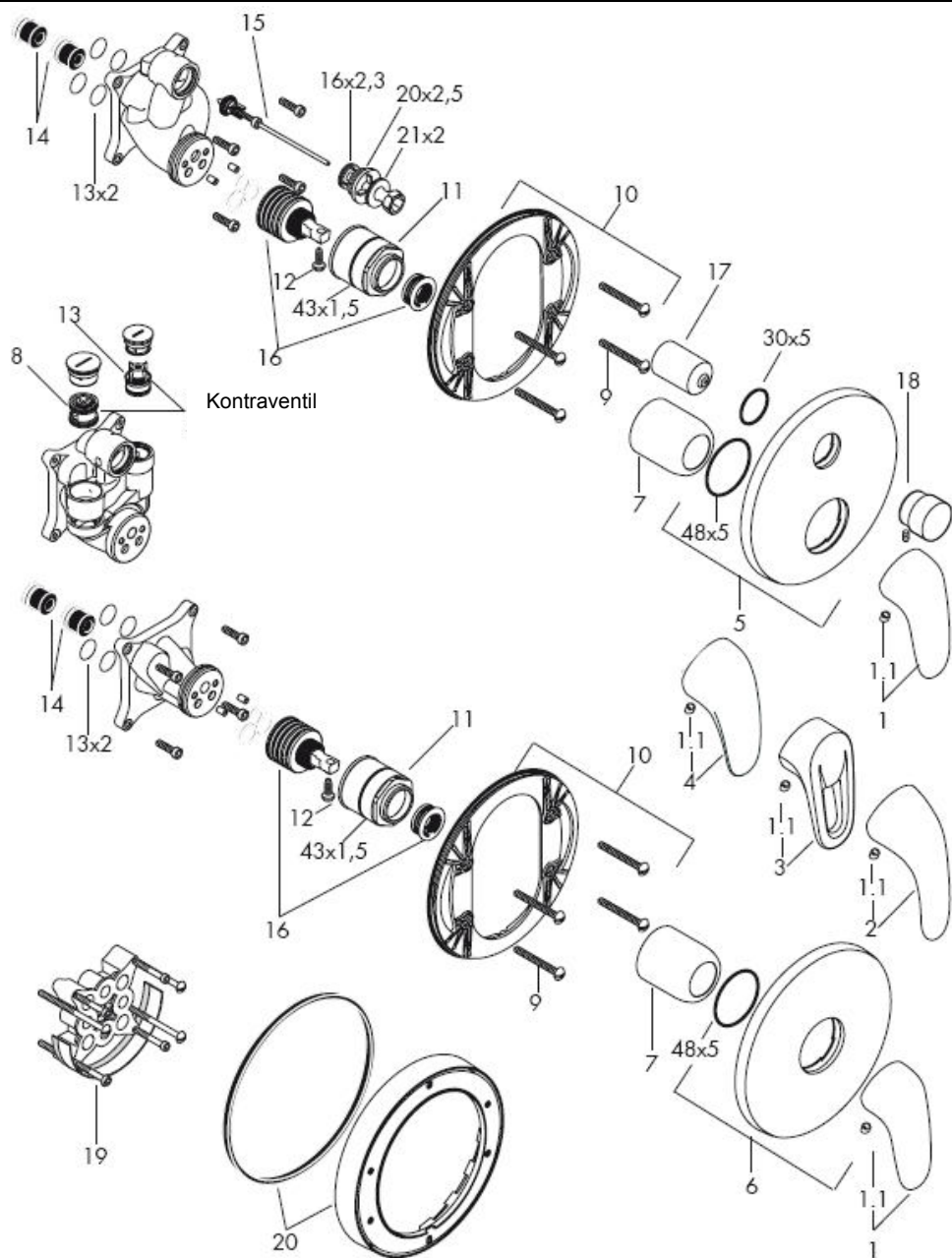

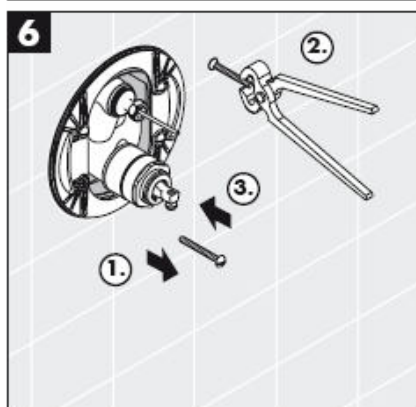
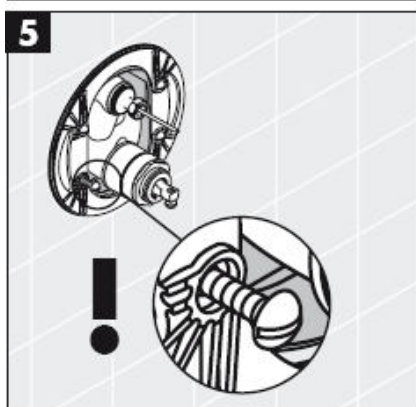
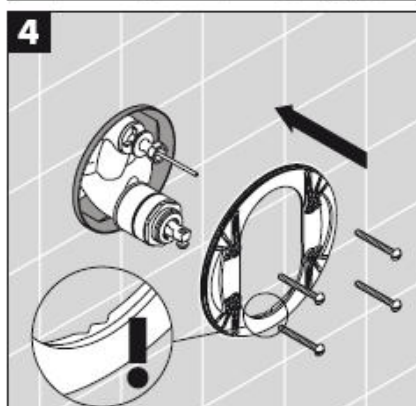
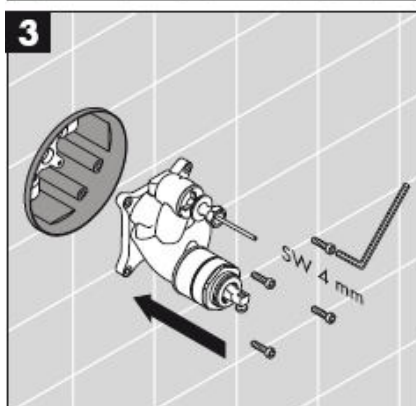
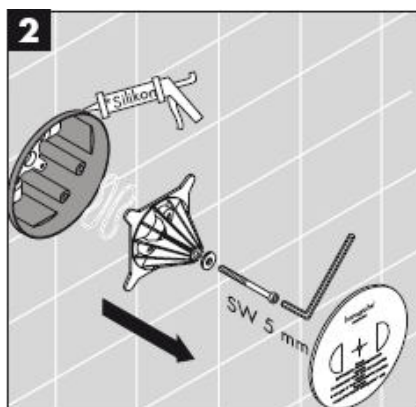
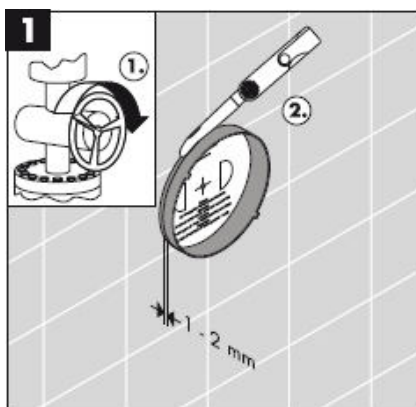

*Silikone (eddikesyre-fri)

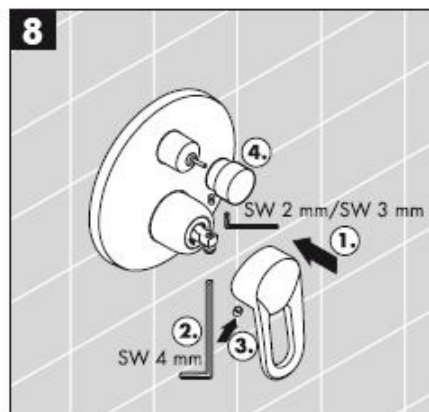
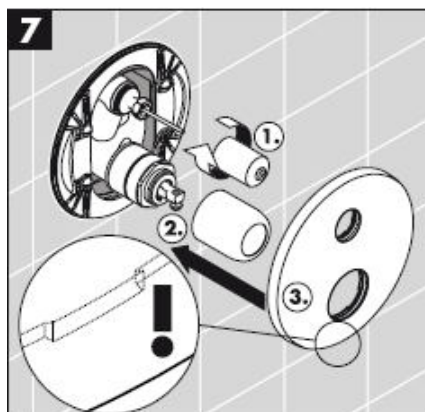

Montering

Advarsel! Ifølge gældende regler, skal armaturet monteres, skylles igennem og afprøves.

Brugsanvisning

Ved at løfte greppet åbnes for vandet. Drej mod venstre for varmt vand og til højre for koldt vand. Omskift til håndbruser ved at trække skifteknappen. Automatisk tilbagesstilling ved at lukke grebet.

Tekniske data

Driftstryk:	max. 1 MPa
Anbefalet driftstryk:	0,1 – 0,5 MPa
Prøvetryk:	1,6 MPa
(1 MPa = 10 bar = 147 PSI)	
Varmtvandstemperatur:	max. 80° C
Anbefalet varmtvandstemperatur:	65° C
Gennemstrømningskapacitet: 0,3 MPa	
14475XXX / 14477XXX /	
31475000 / 31476000 /	
31744000 / 33455000 / 33457000:	
Afgang Badekar	ca. 30 l/min
Afgang Bruser	ca. 24 l/min
14675XXX / 31675000 /	
31761000 / 33665000:	ca. 32 l/min
Med indbygget kontraventil:	14477XXX
	31476000
	33457000

Hansgrohe etgrebsarmaturer kan anvendes i forbindelse med hydraulisk- og termiskstyrede gennemstrømningsvandvarmere ved et vandtryk på 0,15 MPa.

Etgrebsarmaturer med varmtvandsbegrænsning, justering se side 8. I forbindelse med gennemstrømningsvandvarmer er en varmtvandsbegrænsning ikke nødvendig.

Der må ikke indbygges varmtvandsspærre i forbindelse med gennemstrømnings-vandvarmer!

Da der ved evt. defekt vil komme vand i i-boxen, skal denne monteres over karet, således at vandet ledes ned i karet!

Armaturenes (14477XXX/31476000/33457000) sikkerhedsanordning kontrolleres årligt på dennes funktion.

Ifølge DIN EN 1717 skal gennemstrømningsbegrænsere i overensstemmelse med nationale regler afprøves regelmæssigt (mindst en gang om året).

Reserve dele se s. 3

1	Greb Metris E	31094XXX
1.1	Dækknap til greb	96338000
2	Greb Focus E	31791000
3	Greb Metropol E	14094XXX
4	Grebtalis E	33091000
5	Roset	96453XXX
6	Roset	96452XXX
7	Dækroset E	95010XXX
8	Kontraventil	96753000
9	Monteringskrue (4)	96454000
10	Monteringsplade	96447000
11	Møtrik	95007000
12	Skrue	96059000
13	Kontraventil	96655000
14	Støjdæmper	94073000
15	Omstiller	95014000
16	Indmad	92730000
17	Dækroset til omstiller	96448000
18	Trykknapp	95013XXX
19	Forlængersæt 25 mm	13595000
20	Forlængersæt 22 mm	13596000

XXX = Overflade

000 Krom
090 Krom/guld

Dansk

Godkendelse

	DVGW	P-IX	SVGW	NF	WRAS	KIWA
14475XXX	X	PA-IX 9709/ICC	X		X	
14477XXX		PA-IX 18097/IDC				
14675XXX	X	PA-IX 9710/IB	X		X	
31475000	X	PA-IX 9709/ICC	X		X	
31476000		PA-IX 18097/IDC				
31675000	X	PA-IX 9710/IB	X			
31744000	X	PA-IX 9709/IDC	X			
31761000	X	PA-IX 9710/IB	X		X	
33455000	X	PA-IX 9709/IDC	X	X	X	X
33457000	X	PA-IX 18097/IDC	X	X		
33655000	X	PA-IX 9710/IB	X	X		X

Fejl	Årsag	Hjælp
Grebet går trægt	-Kartusche defekt, tilkalket	-Udskift kartusche
Armaturet drypper	-Defekt eller tilkalket kartusche	-Udskift kartusche
Omstiller virker ikke	-For lavt vandtryk -Defekt omstiller	-Forøg vandtrykket -Udskift omstilleren
For lav varmtvandstemperatur. Ingen koldt vand.	-Varmtvandsbegrænsningen er forkert indstillet	-Indstil varmtvandsbe- grænsningen
Vandvarmeren starter, når der åbnes for det kolde vand.	-Kryds-flow	-Udskift kartusche

Varmtvandsbegrænsning: Varmtvandstemperatur 60o C, koldtvandstemperatur 10o C, vandtryk 0,3 MPa.

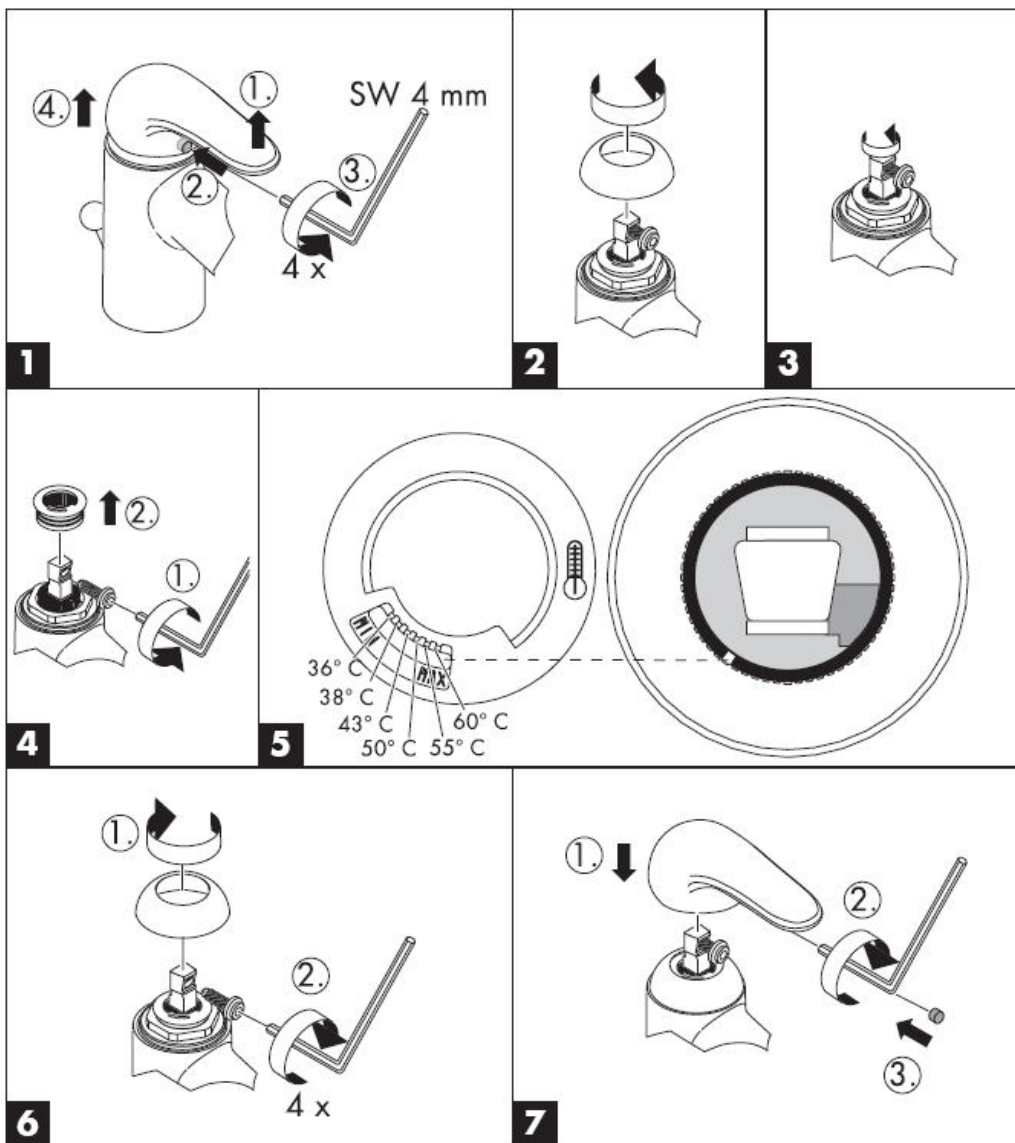

Manual de Instalación



Metropol E
14475XXX/
14477XXX



Metris E
31475000/
31476000



Focus E
31744000



Talis E
33455000/
33457000



Metropol E
14675XXX



Metris E
31675000



Focus E
31761000



Talis E
33655000

hansgrohe

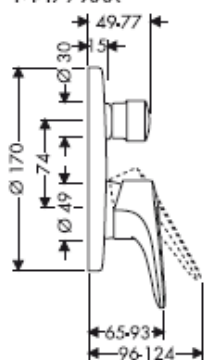
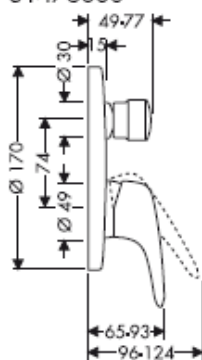
Metropol E14475XXX/
14477XXX**Metris E**31475000/
31476000**Focus E**

31744000

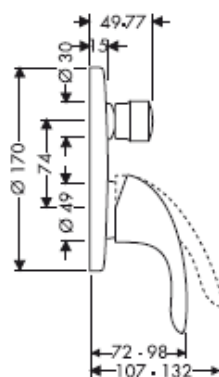
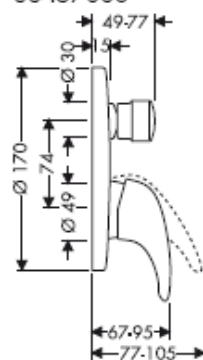
**Talis E**33455000/
33457000**Metropol E**

14675XXX

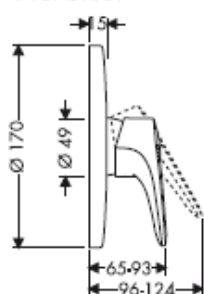
**Metris E**

31675000

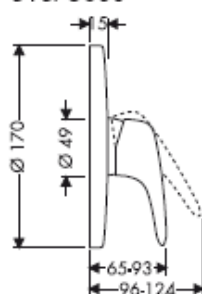
**Focus E**

31761000

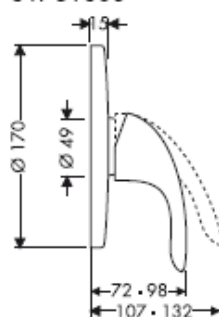
**Talis E**

33655000

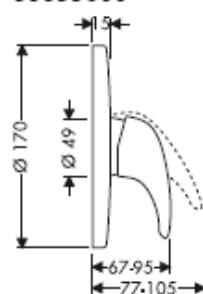

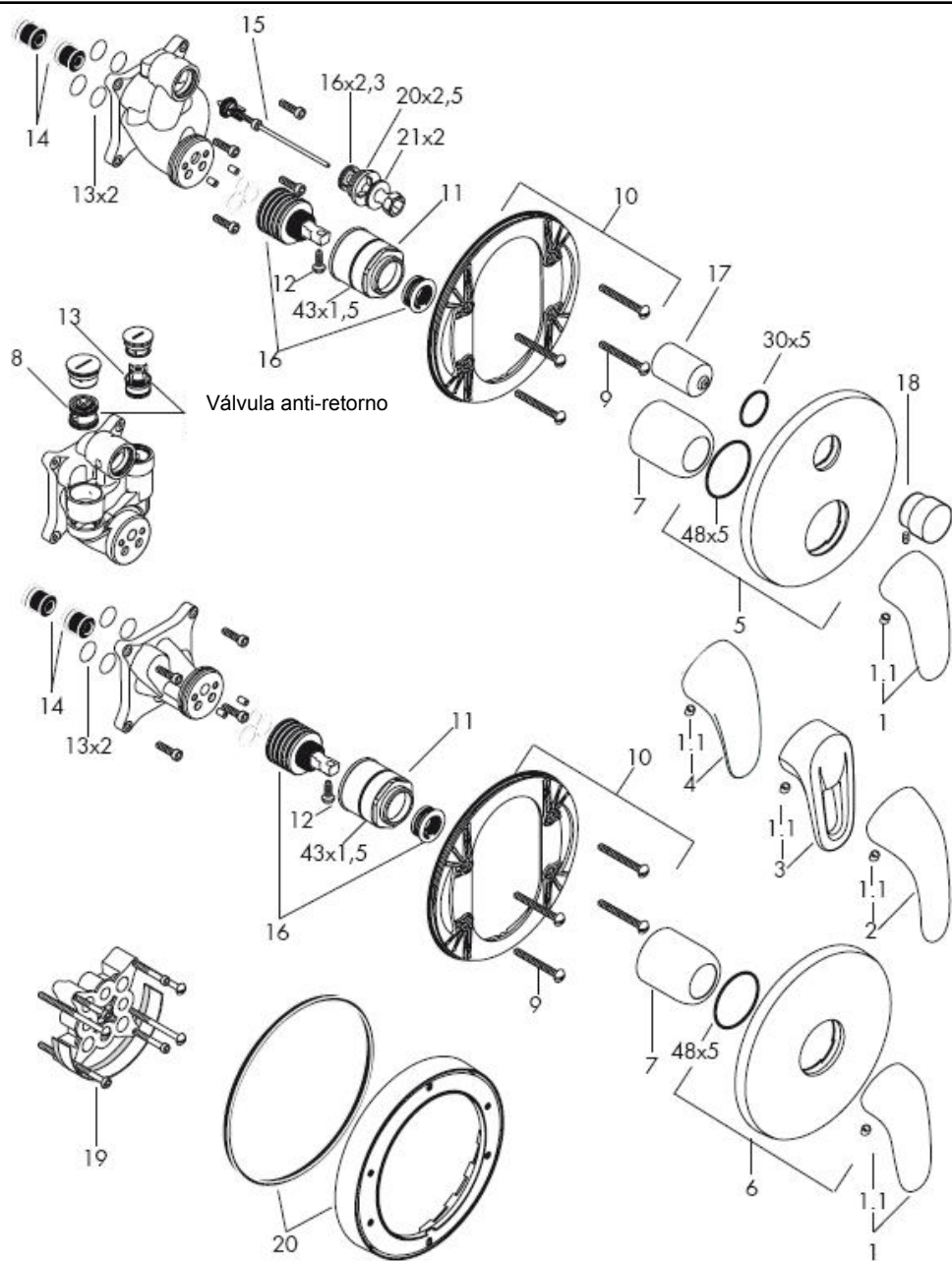

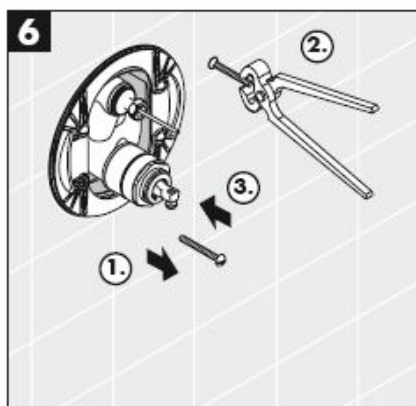
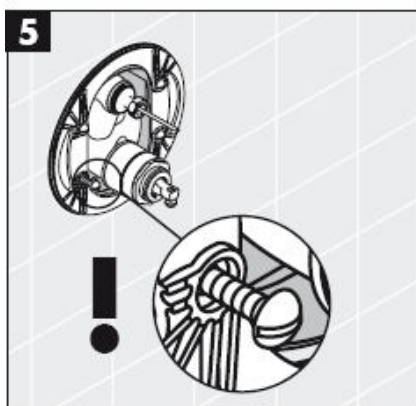
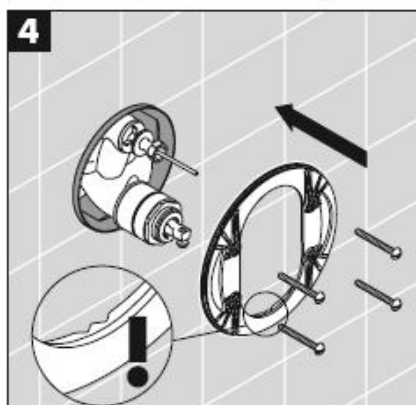
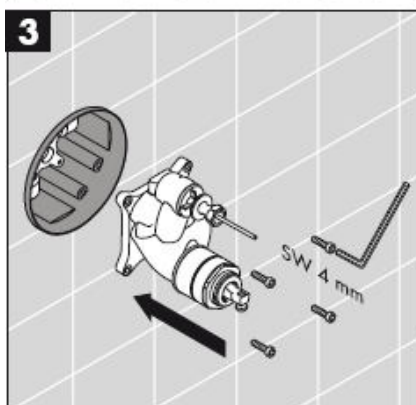
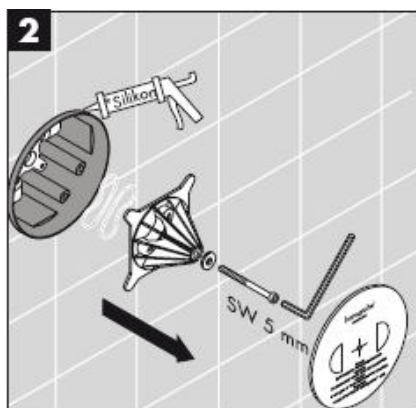
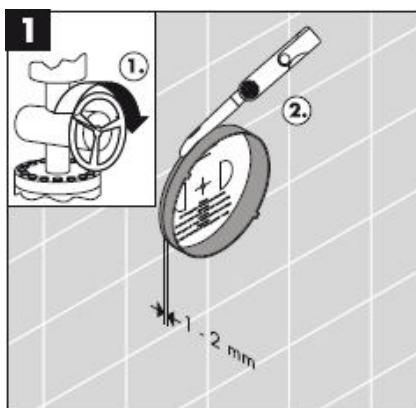

*Silicone (sem ácido acético)

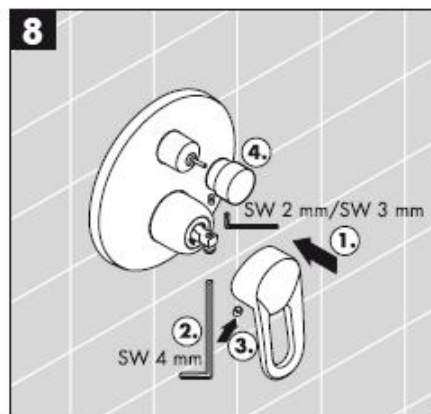
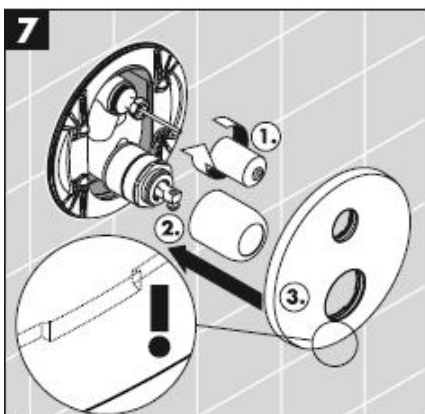

Montagem

Atenção! A misturadora deve ser instalada, purgada e testada de acordo com as normas em vigor!

Funcionamento

Levantar o manípulo para abrir a água.
Rodar para a esquerda = água quente, rodar para a direita = água fria.
O fluxo de água é desviado da banheira para o chuveiro ao puxar o manípulo colocado na parte superior da bica. Depois de fechar a água a misturadora volta automaticamente a debitar água pela bica.

Dados Técnicos

Pressão de funcionamento:	max. 1 MPa
Pressão de func. recomendada:	0,1 – 0,5 MPa
Pressão testada:	1,6 MPa
(1 MPa = 10 bar = 147 PSI)	
Temperatura da água quente:	max. 80° C
Temp. água quente recomendada:	65° C
Caudal: 0,3 MPa	
14475XXX / 14477XXX /	
31475000 / 31476000 /	
31744000 / 33455000 / 33457000:	
Saída Banheira	ca. 30 l/min
Saída Chuveiro	ca. 24 l/min
14675XXX / 31675000 /	
31761000 / 33665000:	ca. 32 l/min
Função anti-retorno e anti-vácuo:	14477XXX
	31476000
	33457000

As misturadoras monocomando Hansgrohe podem ser utilizadas com esquentadores (de controlo térmico ou hidráulico) desde que a pressão de utilização seja, no mínimo, de 0,15 MPa.

Misturadora monocomando equipada com limitador de temperatura (vide pág.8).
Em combinação com caldeira ou esquentador instantâneo o limitador de água quente não se aplica.

Não instalar um bloqueio de água quente em combinação com esquentador.

Instalar a ibox sempre sobre a banheira. No caso de haver algum defeito nas peças da ibox a água pode fluir para lá.

O funcionamento dos dispositivos de segurança das torneiras 14477XXX/31476000/33457000 deve ser controlado uma vez por ano.

As válvulas anti-retorno devem ser verificadas regularmente de acordo com a DIN EN 1717 segundo os regulamentos nacionais ou regionais (pelo menos uma vez por ano).

Peças de substituição ver página 3

1	Manípulo Metris E	31094XXX
1.1	Tampa de parafuso	96338000
2	Manípulo Focus E	31791000
3	Manípulo Metropol E	14094XXX
4	Manípulo Talis E	33091000
5	Cápsula	96453XXX
6	Cápsula	96452XXX
7	Espelho do manípulo E	95010XXX
8	Válvula anti-retorno	96753000
9	Parafusos de fixação (4)	96454000
10	Sede	96447000
11	Porca	95007000
12	Parafuso	96059000
13	Válvula anti-retorno	96655000
14	Redutor de ruído	94073000
15	Inversor compl.	95014000
16	Cartucho (completo)	92730000
17	Cápsula	96448000
18	Manípulo do inversor	95013XXX
19	Crescente 25 mm	13595000
20	Crescente 22 mm	13596000

XXX = Acabamentos

000	cromado
090	cromado/ouro

Marca de controlo

	DVGW	P-IX	SVGW	NF	WRAS	KIWA
14475XXX	X	PA-IX 9709/ICC	X		X	
14477XXX		PA-IX 18097/IDC				
14675XXX	X	PA-IX 9710/IB	X		X	
31475000	X	PA-IX 9709/ICC	X		X	
31476000		PA-IX 18097/IDC				
31675000	X	PA-IX 9710/IB	X			
31744000	X	PA-IX 9709/IDC	X			
31761000	X	PA-IX 9710/IB	X		X	
33455000	X	PA-IX 9709/IDC	X	X	X	X
33457000	X	PA-IX 18097/IDC	X	X		
33655000	X	PA-IX 9710/IB	X	X		X

Falha	Causa	Solução
Misturadora perra	-Cartucho defeituoso, calcificado	-Substituir o cartucho
Misturadora a pingar	-Manga da esfera defeituosa	-Substituir o cartucho
Inversor não funciona	-Pressão da água muito baixa -Inversor defeituoso	-Aumentar a pressão da água -Substituir o inversor
Temperatura da água quente muito baixa, sem água fria. O esquentador dispara quando a água fria está seleccionada.	-O limitador de temperatura está incorrectamente colocado -Fluxo cruzado	-Regular o limitador de temperatura -Substituir o cartucho

Limitador de água quente: Temperatura da água quente 60 C, Temperatura da água fria 10 C, Pressão 0,3 MPa.

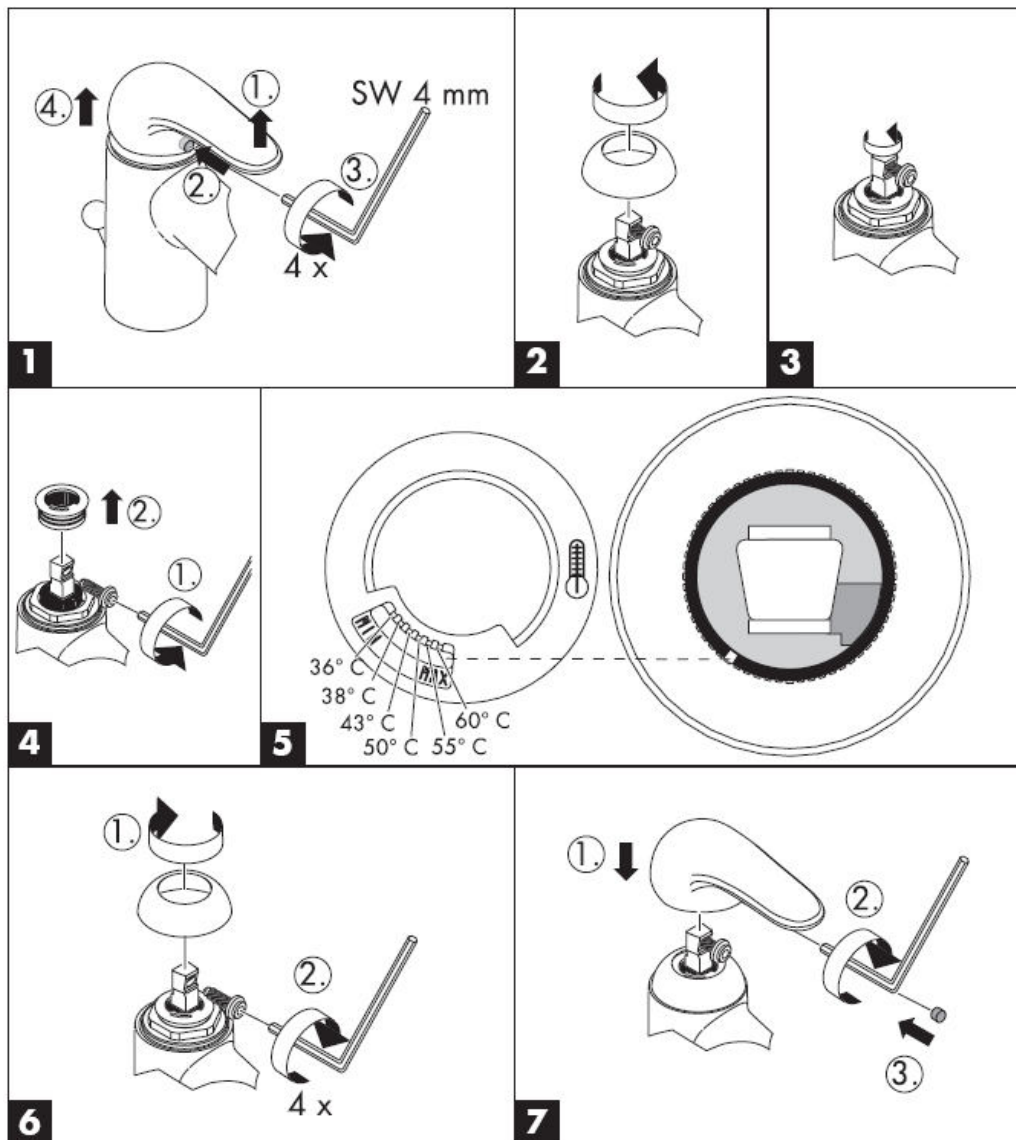

Instrukcja montażu



Metropol E
14475XXX/
14477XXX



Metris E
31475000/
31476000



Focus E
31744000



Talis E
33455000/
33457000



Metropol E
14675XXX



Metris E
31675000



Focus E
31761000



Talis E
33655000

hansgrohe

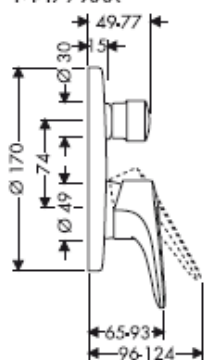
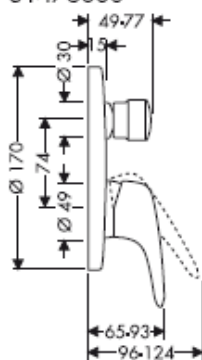
Metropol E14475XXX/
14477XXX**Metris E**31475000/
31476000**Focus E**

31744000

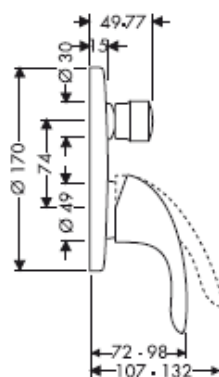
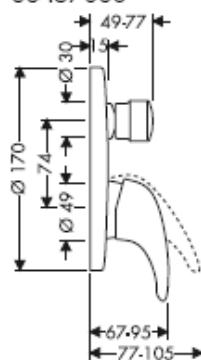
**Talis E**33455000/
33457000**Metropol E**

14675XXX

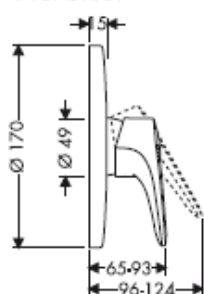
**Metris E**

31675000

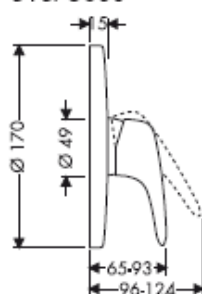
**Focus E**

31761000

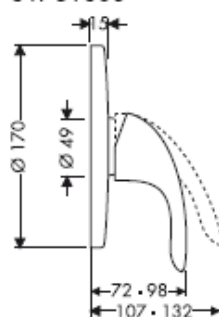
**Talis E**

33655000

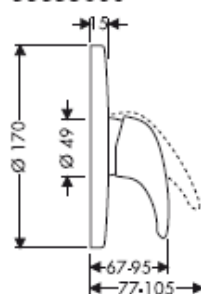

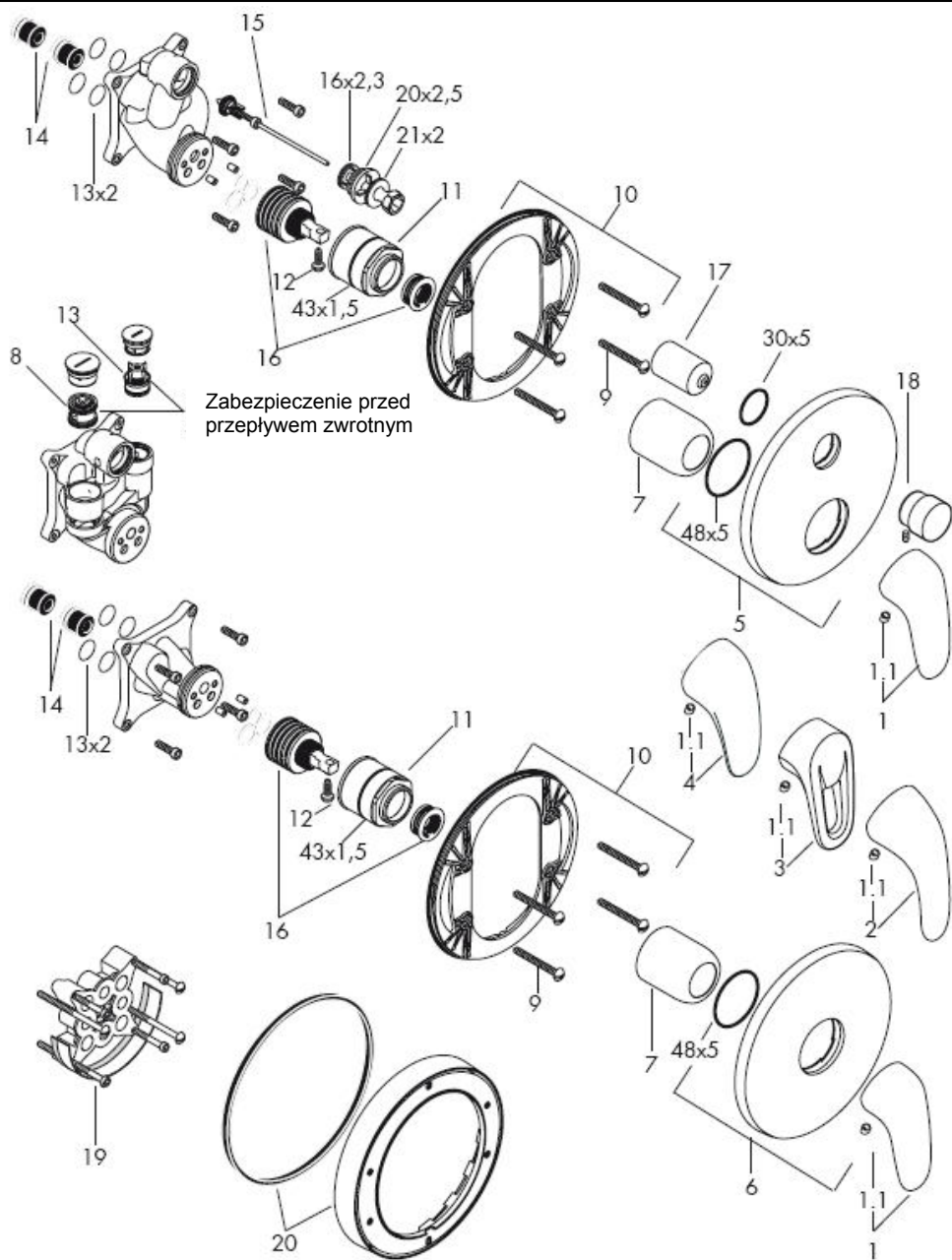

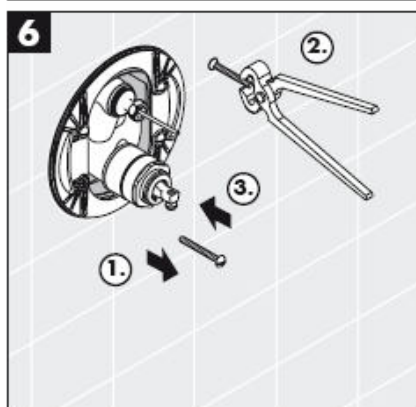
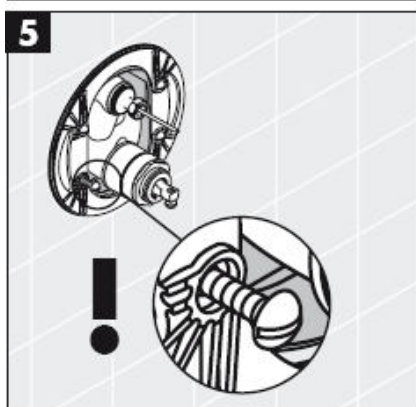
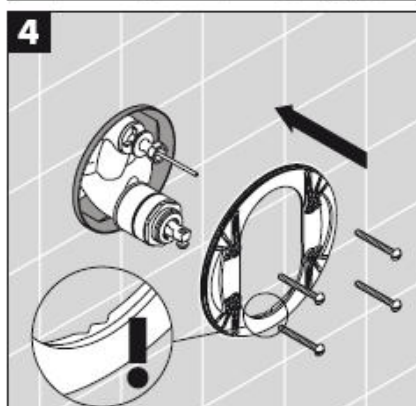
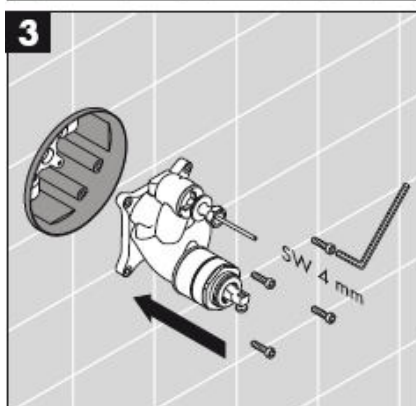
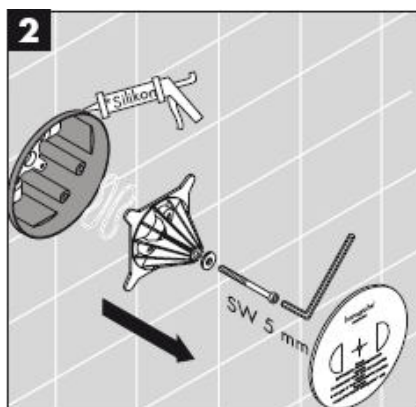
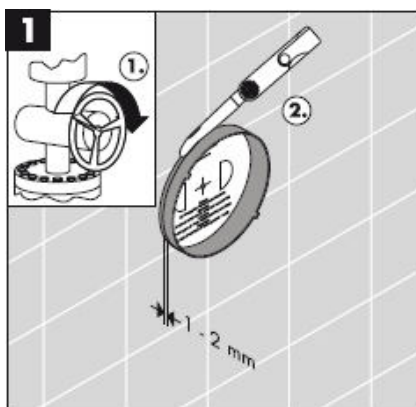

*Silikon (neutralny)

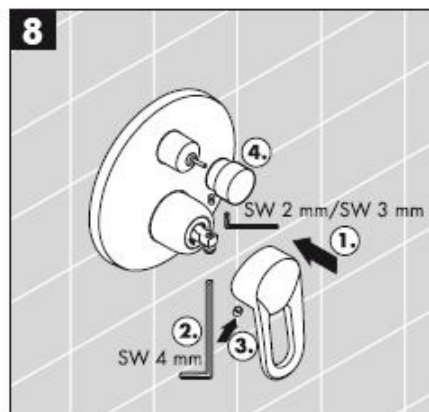
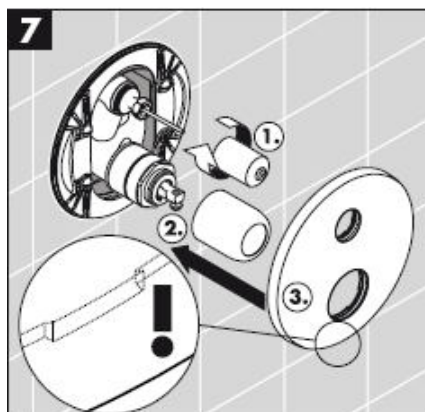

nie można montować ogranicznika temperatury wody.

Montaż

Uwaga! Armatura musi być zamontowana, przepłukana i wypróbowana według obowiązujących norm!

Obsługa

Pociągnięcie rączki natrysku powoduje otwarcie mieszacza.

Odchylenie w lewą stronę= ciepła

woda, odchylenie w prawą stronę= zimna woda.

Przełączenie na prysznic ręczny przez pociągnięcie przełącznika. Ustawienie powrotne uzyskuje się automatycznie po zamknięciu rączki natrysku.

Dane techniczne

Ciśnienie robocze: max. 1 MPa

Zalecane ciśnienie robocze: 0,1 – 0,5 MPa

Ciśnienie próbne: 1,6 MPa

(1 MPa = 10 bary = 147 PSI)

Temperatura wody gorącej: max. 80° C

Zalecana temperatura wody gorącej: 65° C

Wydajność przepływu: 0,3 MPa

14475XXX / 14477XXX /

31475000 / 31476000 /

31744000 / 33455000 / 33457000:

Odpływ Wanna ca. 30 l/min

Odpływ Prysznic ca. 24 l/min

14675XXX / 31675000 /

31761000 / 33665000: ca. 32 l/min

Samoistnie zabezpieczony przed przepływem

zwrotnym: 14477XXX

31476000

33457000

Mieszacze jednouchwytowe Hansgrohe mogą być stosowane w połączeniu z przepływowymi podgrzewaczami wody, sterowanymi hydraulicznie i termicznie, gdy ciśnienie wody wynosi co najmniej 0,15 MPa.

Mieszacz jednouchwytowy z ogranicznikiem temperatury wody, ustawianie, patrz str. 8.

W połączeniu z przepływowym podgrzewaczem wody ogranicznik temperatury wody nie jest konieczny.

	5	Rozeta	96453XXX
	6	Rozeta	96452XXX
	7	Rozeta kulowa E	95010XXX
	8	Napowietrzacz rur	96753000
	9	Śruby rozety nośnej (4)	96454000
	10	Rozeta nośna	96447000
	11	Nakrętka	95007000
	12	Śruba zabezpieczająca	96059000
	13	Zabezpieczenie przed przepływem zwrotnym	96655000
	14	Tłumik	94073000
	15	Przełącznik kpl.	95014000
	16	Wkład kpl.	92730000
	17	Tulejka przełączeniowa	96448000
	18	Łącznik ciągowy	95013XXX
	19	Przedłużacz 25 mm	13595000
	20	Przedłużacz 22 mm	13596000

W przypadku uszkodzenia jakichkolwiek elementów przepływająca woda może kapać z iboxa, dlatego też należy zamontować go nad wanną, dzięki czemu woda będzie mogła spływać do wanny.

Raz w roku należy sprawdzić działanie zabezpieczeń armatur
14477XXX/31476000/33457000.

Działanie zabezpieczeń przed przepływem zwrotnym, zgodnie z normą DIN EN 1717 i miejscowymi przepisami, musi być kontrolowane (DIN 1988, raz w roku).

Części serwisowe patrz strona 3

1	Uchwyt Metris E	31094XXX
1.1	Zaślepka uchwyt	96338000
2	Uchwyt Focus E	31791000
3	Uchwyt Metropol E	14094XXX
4	UchwytTalis E	33091000

XXX = kody wykończenia powierzchni

000 chrom
090 chrom/złoty

Znak jakości

	DVGW	P-IX	SVGW	NF	WRAS	KIWA
14475XXX	X	PA-IX 9709/ICC	X		X	
14477XXX		PA-IX 18097/IDC				
14675XXX	X	PA-IX 9710/IB	X		X	
31475000	X	PA-IX 9709/ICC	X		X	
31476000		PA-IX 18097/IDC				
31675000	X	PA-IX 9710/IB	X			
31744000	X	PA-IX 9709/IDC	X			
31761000	X	PA-IX 9710/IB	X		X	
33455000	X	PA-IX 9709/IDC	X	X	X	X
33457000	X	PA-IX 18097/IDC	X	X		
33655000	X	PA-IX 9710/IB	X	X		X

Usterka

Przyczyna

Pomoc

Uchwyt armatury pracuje z wysiłkiem	-Uszkodzony wkład, zakamieniony	-Wymiana wkładu
Armatura cieknie	-Uszkodzony wkład, osady	-Wymiana wkładu
Przełącznik nie funkcjonuje	-Zbyt niskie ciśnienie wody -Uszkodzony przełącznik	-Podnieść ciśnienie wody -Wymienić przełącznik
Za niska temperatura ciepłej wody, brak zimnej wody.	-Niewłaściwe ustawienie ogranicznik ciepłej wody	-Ustawić ogranicznik ciepłej wody
Przepływowcy podgrzewacz wody uruchamia się, gdy wybiera się zimną wodę.	-Przepływ krzyżowy	-Wymiana wkładu

Ogranicznik ciepłej wody: Temperatura ciepłej wody 60 C, temperatura zimnej wody 10 C, ciśnienie przepływu 0,3 MPa.

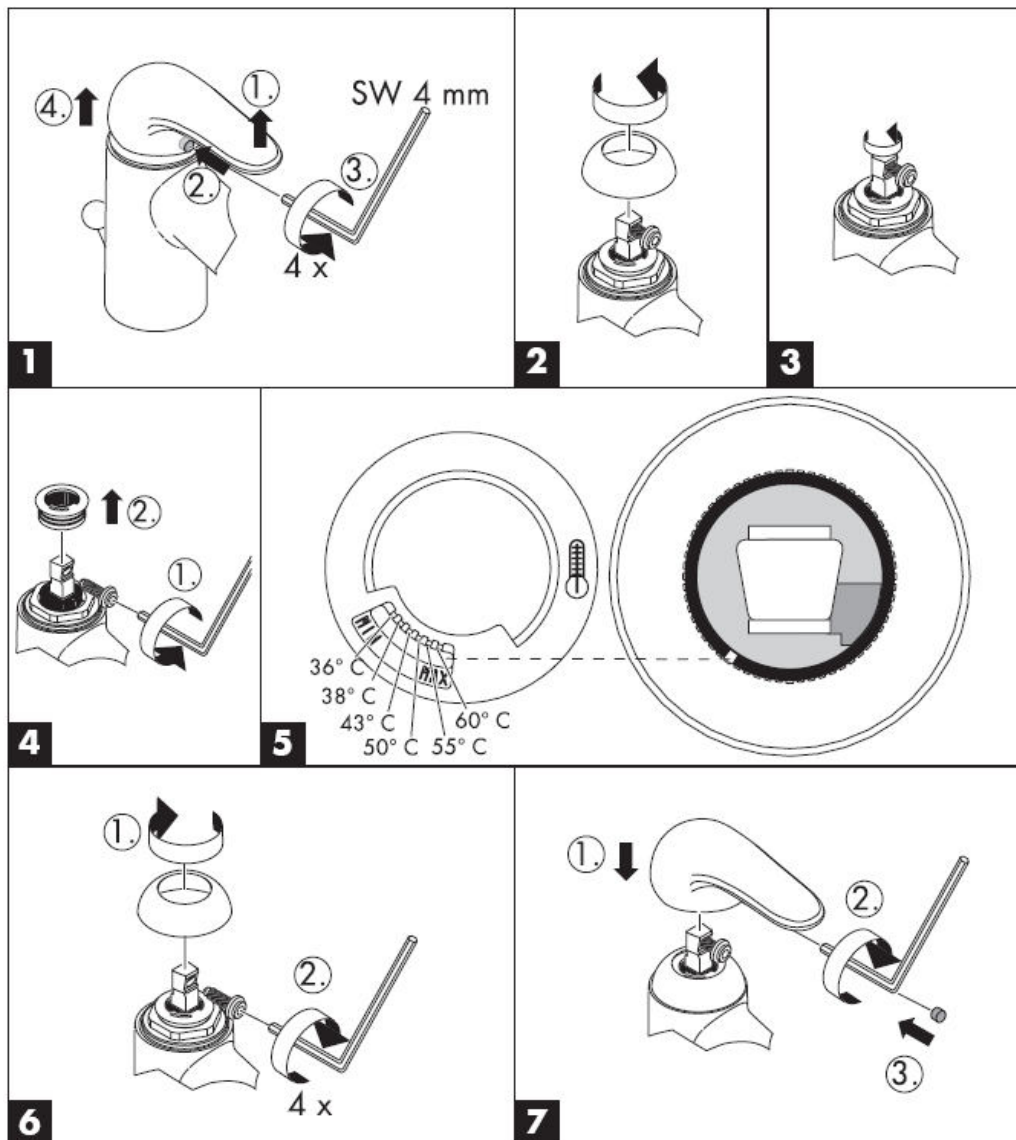

Montážní návod



Metropol E
14475XXX/
14477XXX



Metris E
31475000/
31476000



Focus E
31744000



Talis E
33455000/
33457000

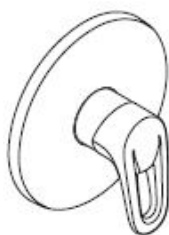

Metropol E
14675XXX



Metris E
31675000



Focus E
31761000



Talis E
33655000

hansgrohe

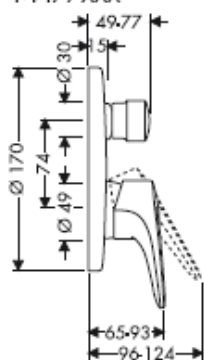
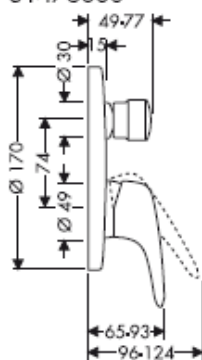
Metropol E14475XXX/
14477XXX**Metris E**31475000/
31476000**Focus E**

31744000

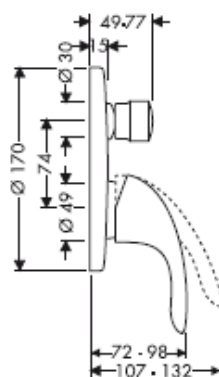
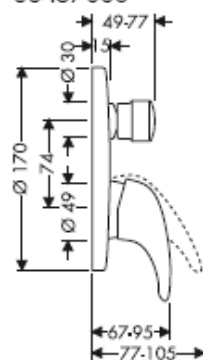
**Talis E**33455000/
33457000**Metropol E**

14675XXX

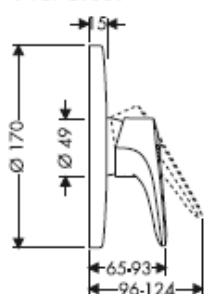
**Metris E**

31675000

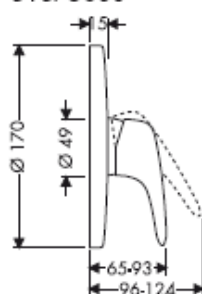
**Focus E**

31761000

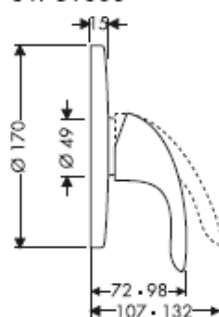
**Talis E**

33655000

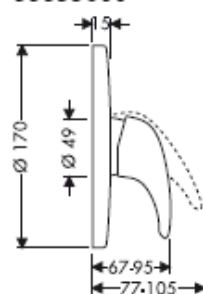

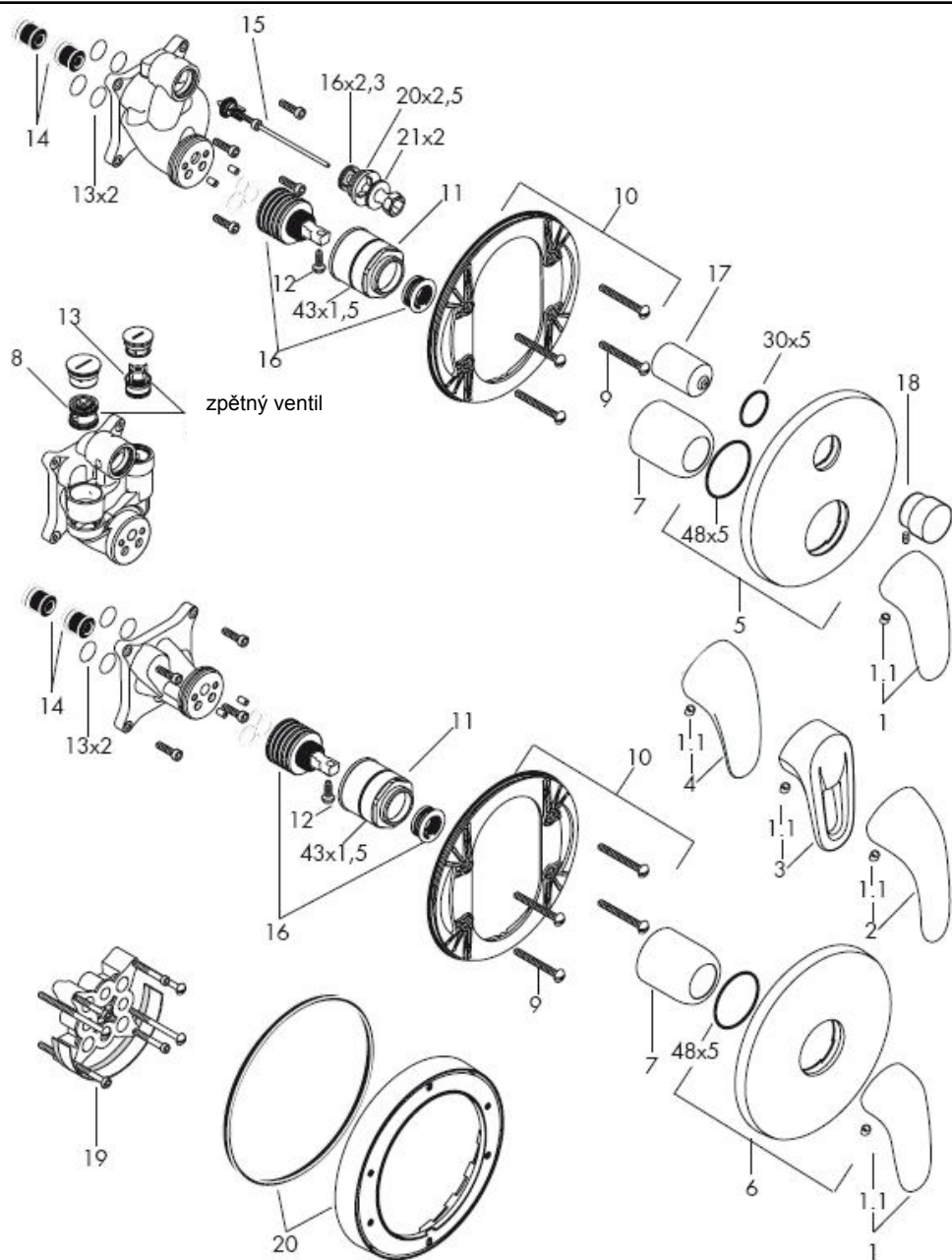

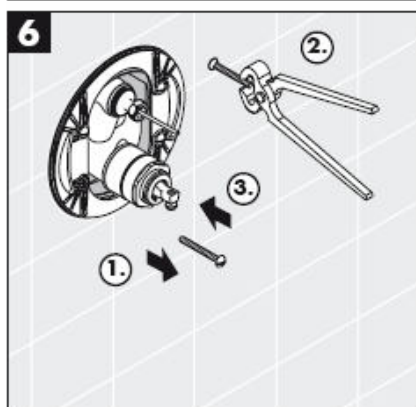
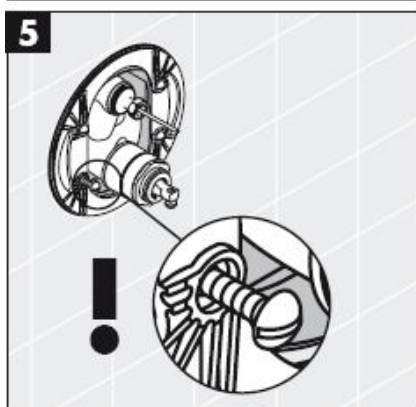
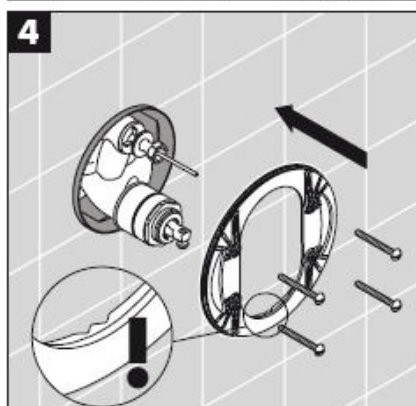
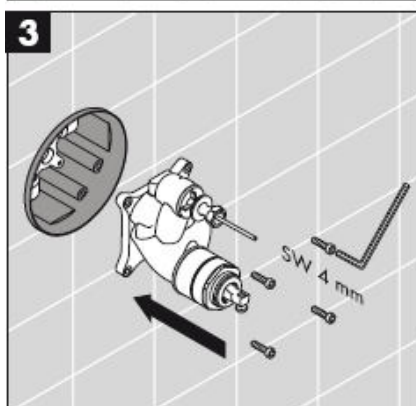
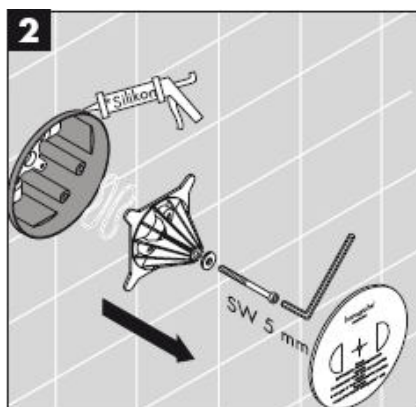
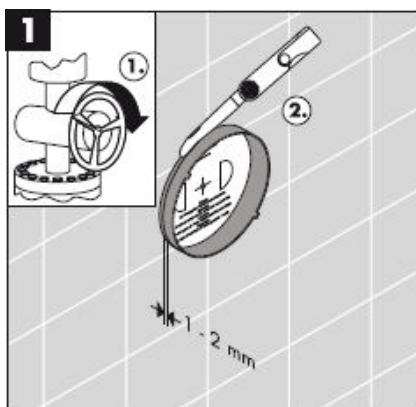

*Silikon (bez kyseliny octové!)

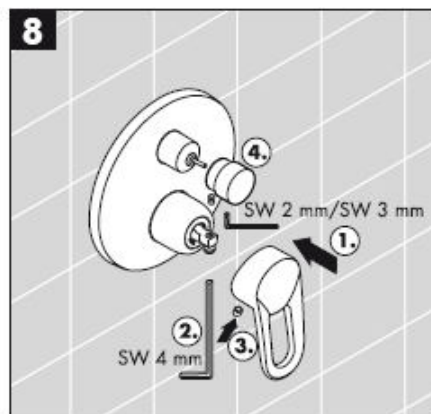
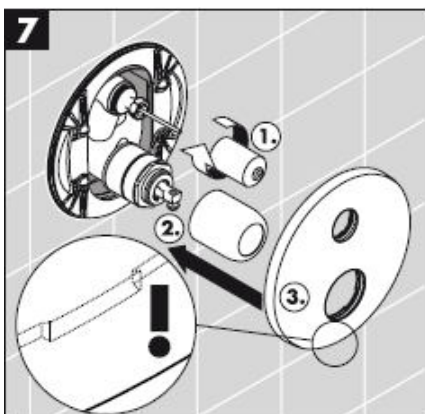

Montáž

Pozor! Armatura se musí montovat, proplachovat a testovat podle platných norem!

Ovládání

Baterie se otevírá zvednutím rukojeti. Otočení doleva = teplá voda, doprava = studená voda. Přepnutí na ruční sprchu se provede vytáhnutím přepínacího knoflíku. K navrácení dojde automaticky uzavřením rukojeti.

Technické údaje

Provozní tlak:	max. 1 MPa
Doporučený provozní tlak:	0,1 – 0,5 MPa
Zkušební tlak:	1,6 MPa
(1 MPa = 10 barů = 147 PSI)	
Teplota horké vody:	max. 80° C
Doporučená teplota horké vody:	65° C
Průtok: 0,3 MPa	
14475XXX / 14477XXX /	
31475000 / 31476000 /	
31744000 / 33455000 / 33457000:	
odpad Vana	ca. 30 l/min
odpad Sprcha	ca. 24 l/min
14675XXX / 31675000 /	
31761000 / 33665000:	ca. 32 l/min
Vlastní jištění proti zpětnému nasátí.:	14477XXX
	31476000
	33457000

Pákové baterie Hansgrohe mohou být používány ve spojení s hydraulicky nebo tepelně řízenými průtokovými ohřivači, pokud tlak při průtoku je alespoň 0,15 MPa.

Pákové baterie s omezením horké vody, seřízení viz. str. 8. Ve spojení s průtokovými ohřivači není uzavěr teplé vody nutný.

Ve spojení s průtokovým ohřivačem nesmí být instalován žádný uzavěr teplé vody!

Protože v případě závady funkčních dílů může začít z jednotky i box vytékat voda, musí být i box instalován nad vanou, která vytékající vodu odvede.

Funkce bezpečnostních prvků armatur 14477XXX/31476000/33457000 se musí kontrolovat jednou za rok.

U zpětných ventilů se musí podle DIN EN 1717 v souladu s národními nebo regionálními předpisy testovat jejich funkčnost (alespoň jednou ročně).

Servisní díly viz strana 3

1	rukojeť Metris E	31094XXX
1.1	krytka šroubu	96338000
2	rukojeť Focus E	31791000
3	rukojeť Metropol E	14094XXX
4	rukojeťTalis E	33091000
5	rozeta	96453XXX
6	rozeta	96452XXX
7	kulová rozeta E	95010XXX
8	zpětný ventil	96753000
9	Nosné šrouby (4)	96454000
10	Nosná rozeta	96447000
11	matka	95007000
12	Pojistný šroub	96059000
13	zpětný ventil	96655000
14	zvuková izolace	94073000
15	přepínač kompl.	95014000
16	kartuše kompl.	92730000
17	Pouzdro přepínače	96448000
18	knoflík táhla	95013XXX
19	prodloužení 25 mm	13595000
20	prodloužení 22 mm	13596000

XXX = kód povrchové úpravy

000	chrom
090	chrom/zlato

zkušební značka

	DVGW	P-IX	SVGW	NF	WRAS	KIWA
14475XXX	X	PA-IX 9709/ICC	X		X	
14477XXX		PA-IX 18097/IDC				
14675XXX	X	PA-IX 9710/IB	X		X	
31475000	X	PA-IX 9709/ICC	X		X	
31476000		PA-IX 18097/IDC				
31675000	X	PA-IX 9710/IB	X			
31744000	X	PA-IX 9709/IDC	X			
31761000	X	PA-IX 9710/IB	X		X	
33455000	X	PA-IX 9709/IDC	X	X	X	X
33457000	X	PA-IX 18097/IDC	X	X		
33655000	X	PA-IX 9710/IB	X	X		X

Porucha	Příčina	Odstranění
Armatura jde ztěžka	-Kartuše je vadná, zanesená vodním kamenem	-Kartuši vyměnit
Armatura odkapává	-kartuše je vadná, usazeniny	-Kartuši vyměnit
Přepínač nefunguje	-příliš malý tlak vody -přepínač defektní	-zvýšit tlak vody -Přepínač vyměnit
nízká teplota teplé vody .žádná studená voda průtokový ohříváč naskočí, když se navolí studená voda	-Špatně nastavená zarážka pro teplou vodu -Křížení toků	-Seříditi zarážku pro teplou vodu -Kartuši vyměnit

Omezení teplé vody: teplota vody (teplé) 60 C, teplota studené vody 10 C, tlak proudu 0,3 MPa.

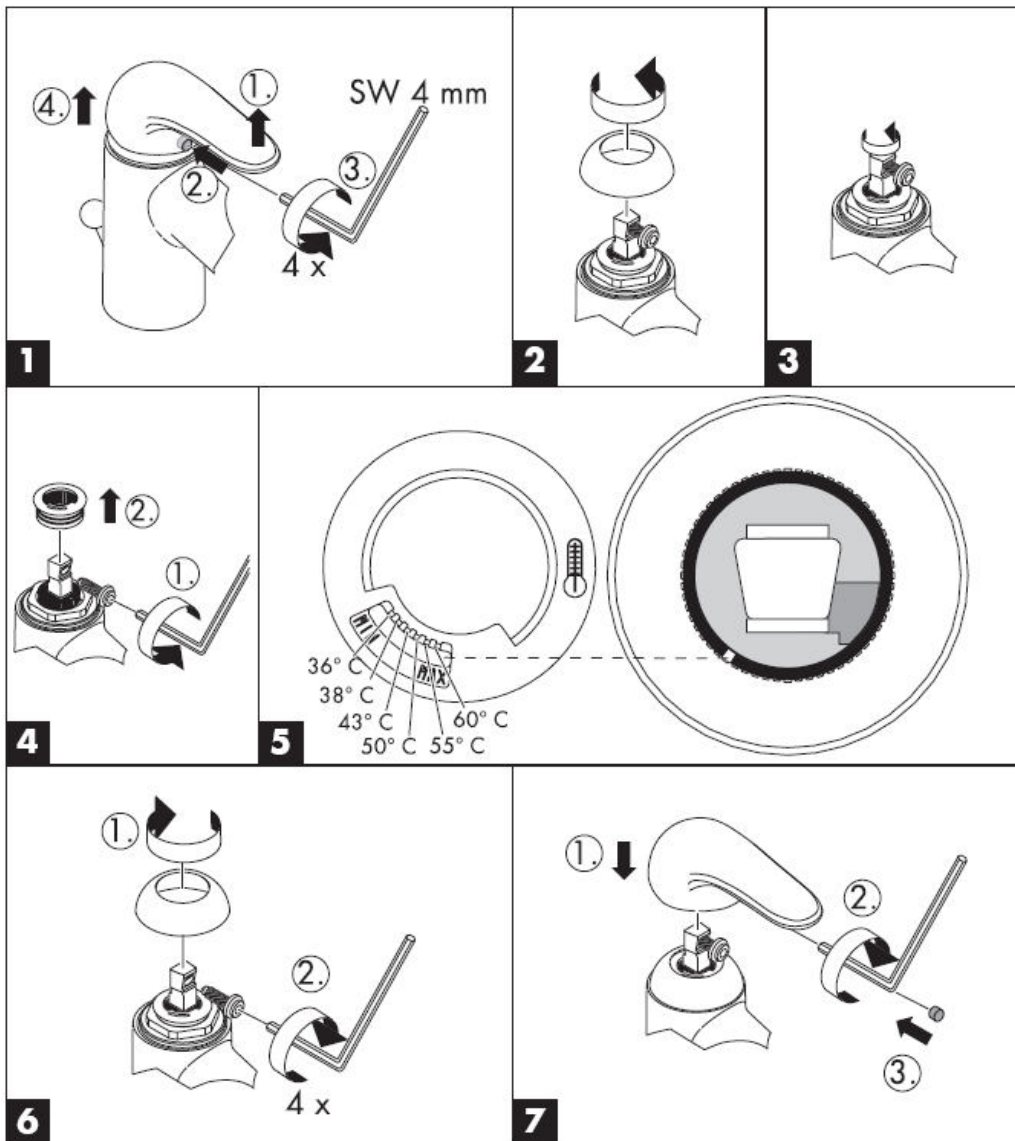

Hansgrohe

Montážny návod



Metropol E
14475XXX/
14477XXX



Metris E
31475000/
31476000



Focus E
31744000



Talis E
33455000/
33457000



Metropol E
14675XXX



Metris E
31675000



Focus E
31761000



Talis E
33655000

hansgrohe

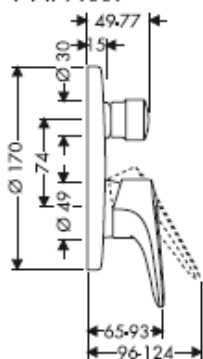
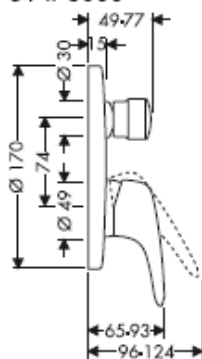
Metropol E14475XXX/
14477XXX**Metris E**31475000/
31476000**Focus E**

31744000

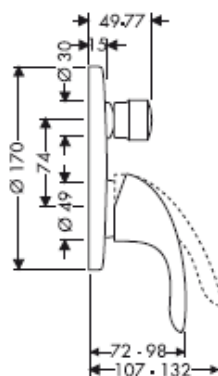
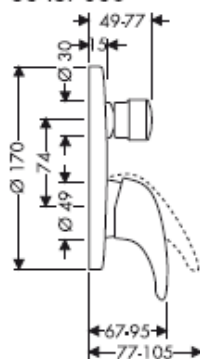
**Talis E**33455000/
33457000**Metropol E**

14675XXX

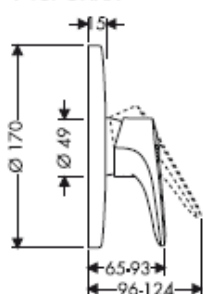
**Metris E**

31675000

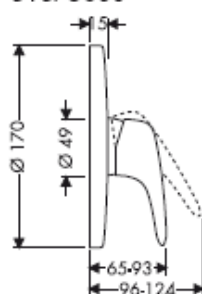
**Focus E**

31761000

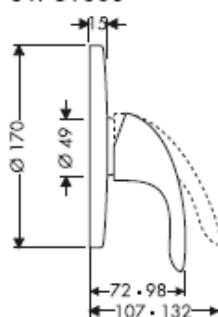
**Talis E**

33655000

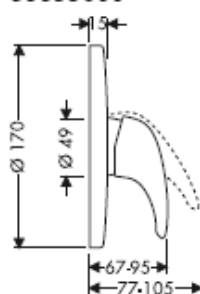

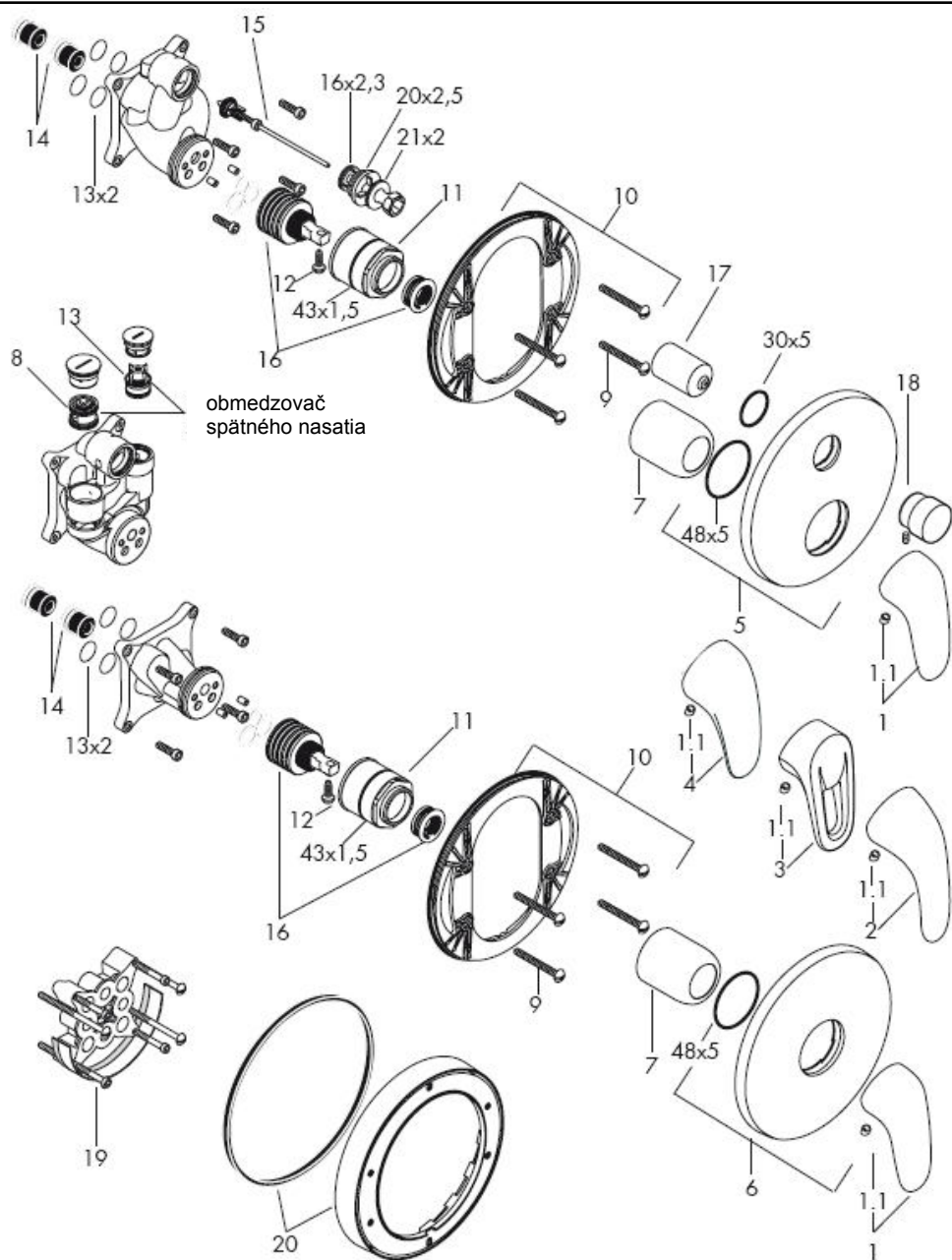

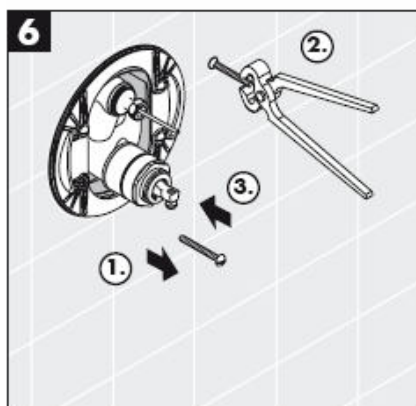
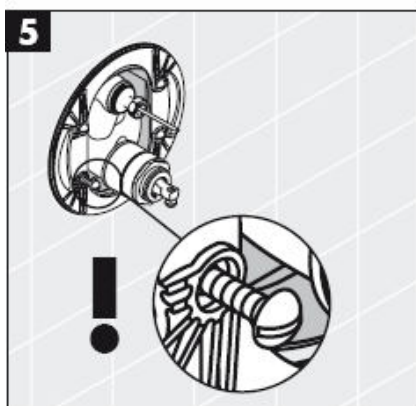
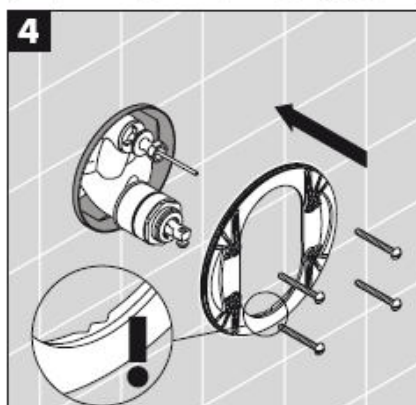
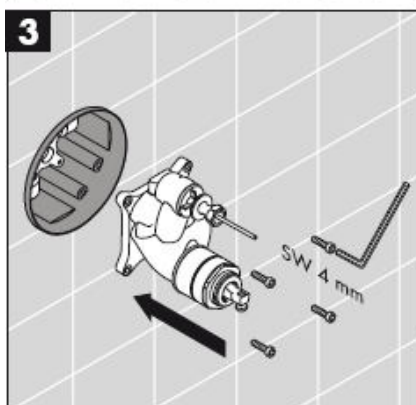
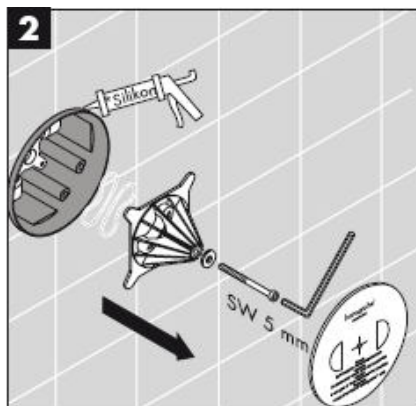
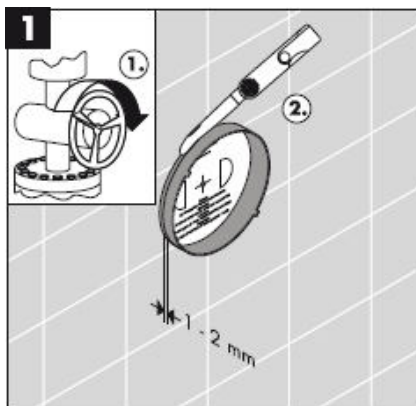

*Silikon (bez kyseliny octovej!)

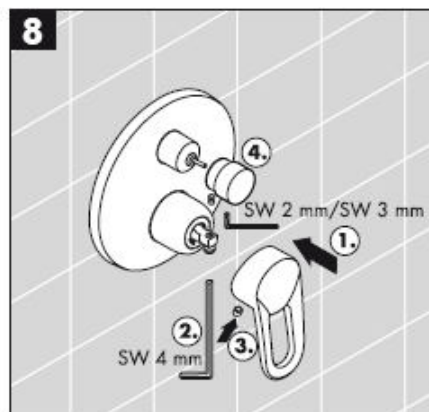
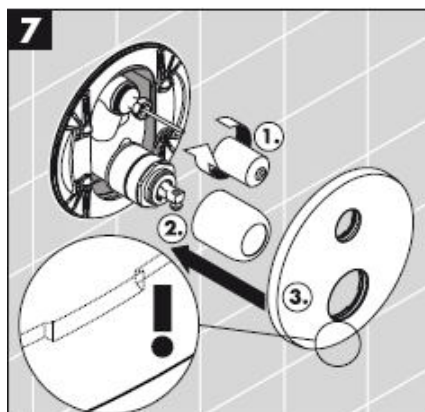

Montáž

Pozor! Batéria sa musí montovať, preplachovať a testovať podľa platných noriem!

Obsluha

Nadvihnutím páky sa zmiešavacia batéria otvorí. Otočenie doľava = teplá voda, doprava = studená voda

Prestavenie na sprchu je možné vytiahnutím gombíka prepnutia na hornej strane výstupu vody. Nastavenie späť sa uskutočňuje automaticky po uzavretí páky.

Technické údaje

Prevádzkový tlak:	max. 1 MPa
Doporučený prevádzkový tlak:	0,1 – 0,5 MPa
Skúšobný tlak:	1,6 MPa
(1 MPa = 10 barov = 147 PSI)	
Teplota teplej vody:	max. 80° C
Doporučená teplota teplej vody:	65° C
Prietok: 0,3 MPa	
14475XXX / 14477XXX /	
31475000 / 31476000 /	
31744000 / 33455000 / 33457000:	
odtok Vaňa	ca. 30 l/min
odtok Sprcha	ca. 24 l/min
14675XXX / 31675000 /	
31761000 / 33665000:	ca. 32 l/min
Vlastná poistka proti spätnému nasatiu.:	
	14477XXX
	31476000
	33457000

Pákové batérie firmy Hansgrohe môžu byť používané v spojení s hydraulicky a tepelne riadenými prietokovými ohrievačmi, pokiaľ je tlak prúdu aspoň 0,15 MPa.

Páková batéria s obmedzením teplej vody, nastavenie vid' str. 8.

V spojení s prietokovými ohrievačmi nie je uzáver teplej vody nutný.

V spojení s prietokovým ohrievačom nesmie byť použitý žiadny uzáver teplej vody!

Pretože v prípade poruchy funkčných častí môže začať z jednotky ibox vytekať voda, musí byť ibox namontovaný nad vaňou, ktorá vytekajúcu vodu odvedie.

Istiacie zariadenie batérií

14477XXX/31476000/33457000 je nutné kontrolovať raz ročne.

Pri spätných ventiloch sa musí podľa DIN EN 1717 v súlade s národnými alebo regionálnymi predpismi testovať ich funkčnosť (aspoň raz ročne).

Servisné diely vid' strana 3

1	rukoväť Metris E	31094XXX
1.1	kryt skrutky	96338000
2	rukoväť Focus E	31791000
3	rukoväť Metropol E	14094XXX
4	rukoväť Talis E	33091000
5	ružica	96453XXX
6	ružica	96452XXX
7	gul'ová rozeta E	95010XXX
8	obmedzovač spätného nasatia	96753000
9	Nosné skrutky (4)	96454000
10	Nosná rozeta	96447000
11	matica	95007000
12	Poistná skrutka	96059000
13	obmedzovač spätného nasatia	96655000
14	zvuková izolácia	94073000
15	prepínač kompl.	95014000
16	kartuša kompl.	92730000
17	Krycia rozeta prepínača	96448000
18	kryt tiahla	95013XXX
19	0 25 mm	13595000
20	0 22 mm	13596000

XXX = kód povrchovej úpravy

000 chróm

090 chróm/zlato

Osvedčenie o skúške

	DVGW	P-IX	SVGW	NF	WRAS	KIWA
14475XXX	X	PA-IX 9709/ICC	X		X	
14477XXX		PA-IX 18097/IDC				
14675XXX	X	PA-IX 9710/IB	X		X	
31475000	X	PA-IX 9709/ICC	X		X	
31476000		PA-IX 18097/IDC				
31675000	X	PA-IX 9710/IB	X			
31744000	X	PA-IX 9709/IDC	X			
31761000	X	PA-IX 9710/IB	X		X	
33455000	X	PA-IX 9709/IDC	X	X	X	X
33457000	X	PA-IX 18097/IDC	X	X		
33655000	X	PA-IX 9710/IB	X	X		X

Porucha	Príčina	Pomoc
Armatúra "chodí" ťažko	-Kartuša je poškodená, vápenaté usadeniny	-Vymeniť kartušu
Armatúra pušča	-Chybná kartuša, usadeniny	-Vymeniť kartušu
Prepínač nefunguje	-Príliš malý tlak vody -Prepínač defektný	-Zvýšiť tlak vody -Prepínač vymeniť
Málo teplá voda, žiadna studená voda, prietokový ohrievač naskočí, keď sa navolí studená voda.	-Nesprávne nastavená zarážka na teplú vodu -Križenie tokov	-Nastavenie zarážky na teplú vodu -Vymeniť kartušu

Obmedzenie teplej vody: teplota teplej vody 60 °C, teplota studenej vody 10 °C, tlak prúdu 0,3 MPa.

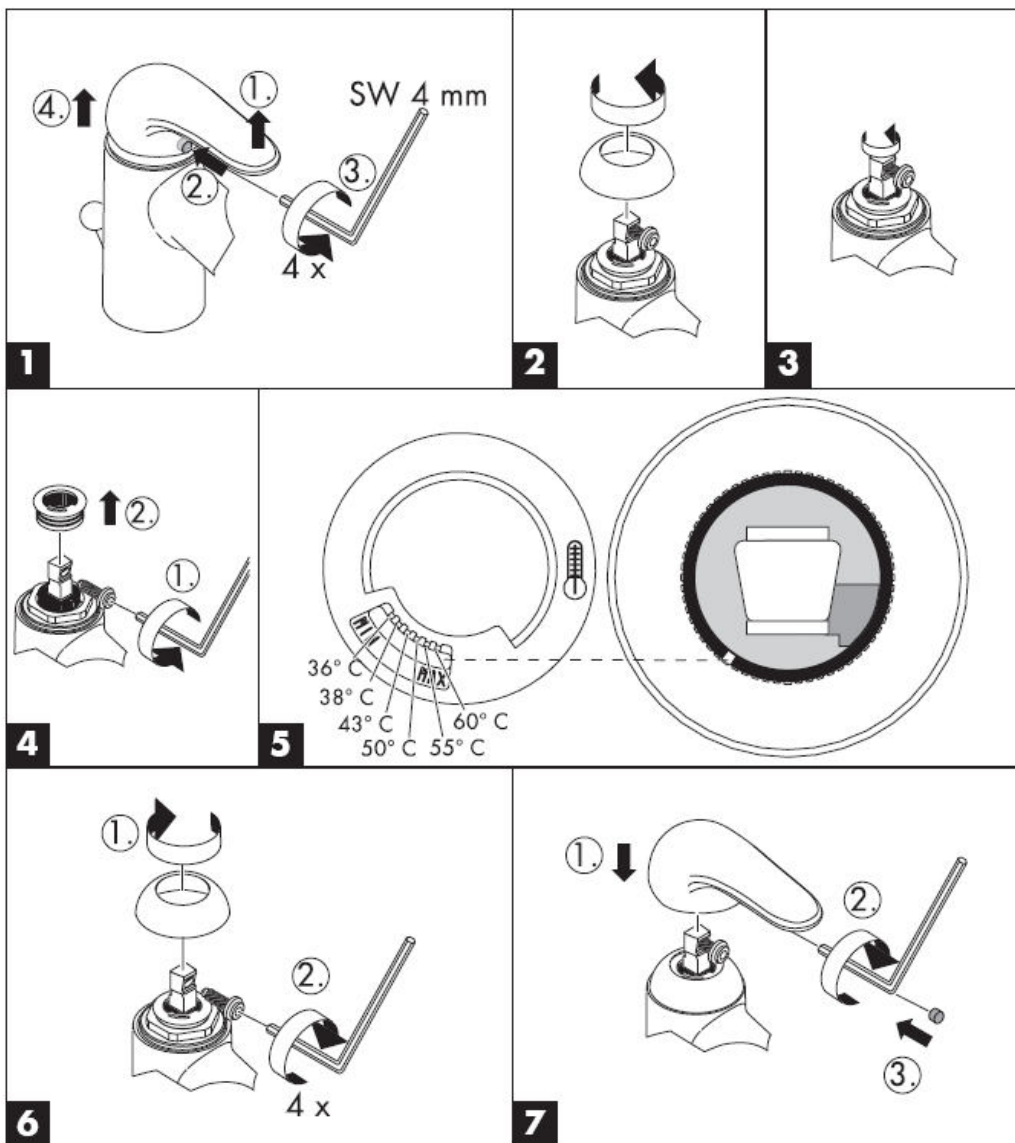

组装说明



Metropol E
14475XXX/
14477XXX



Metris E
31475000/
31476000



Focus E
31744000



Talis E
33455000/
33457000



Metropol E
14675XXX



Metris E
31675000



Focus E
31761000



Talis E
33655000

hansgrohe

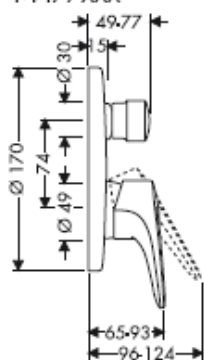
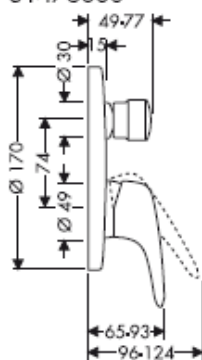
Metropol E14475XXX/
14477XXX**Metris E**31475000/
31476000**Focus E**

31744000

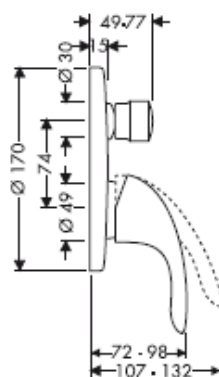
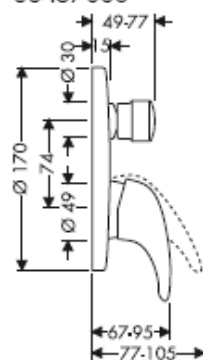
**Talis E**33455000/
33457000**Metropol E**

14675XXX

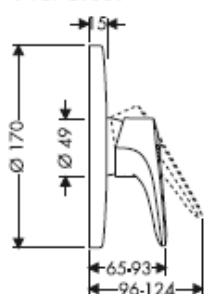
**Metris E**

31675000

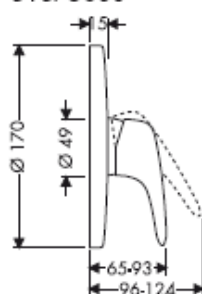
**Focus E**

31761000

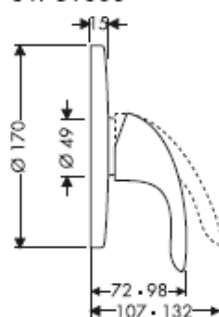
**Talis E**

33655000

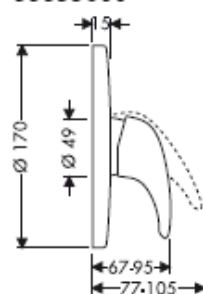

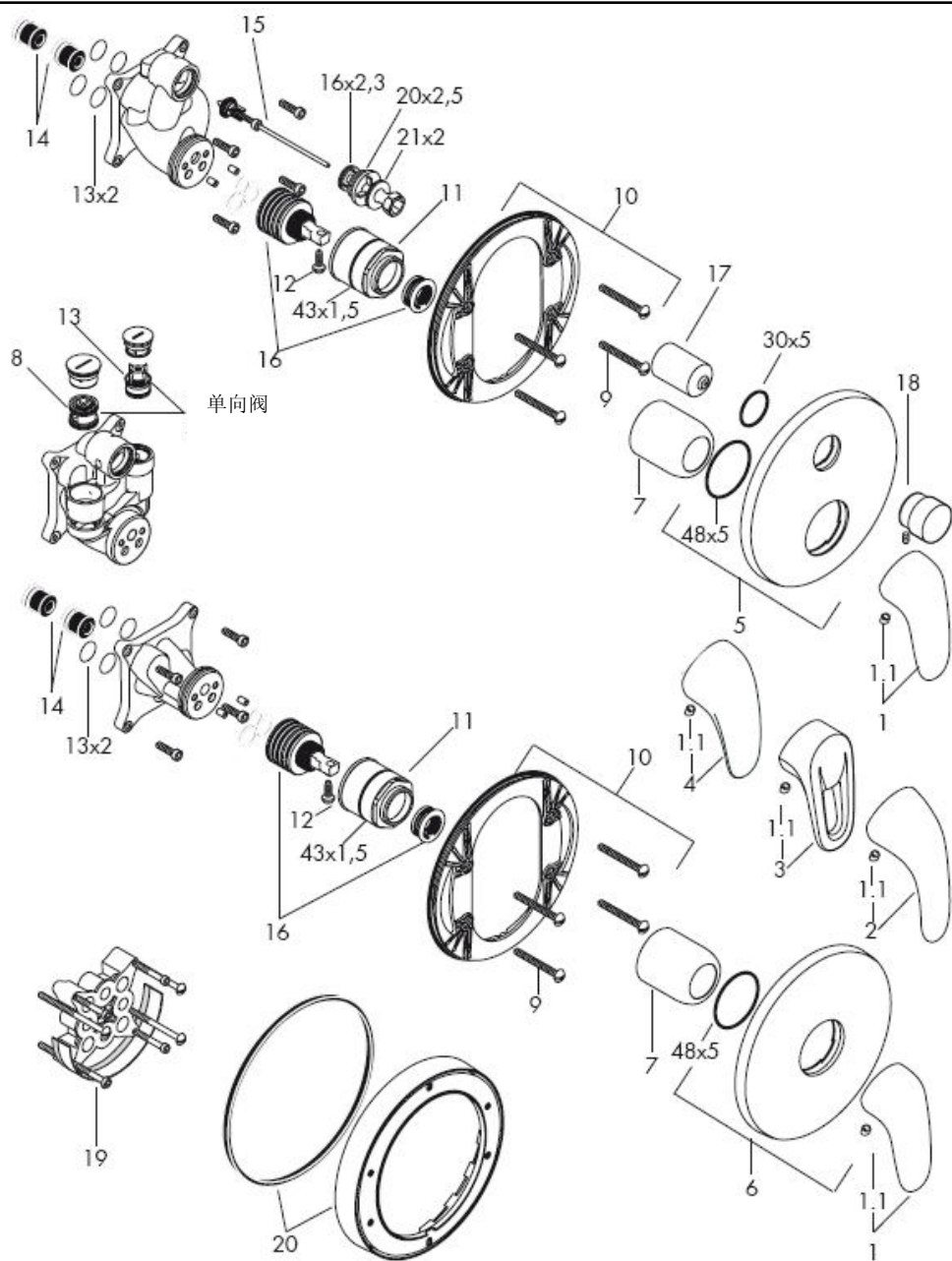

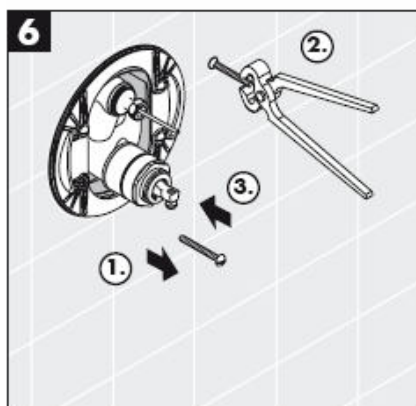
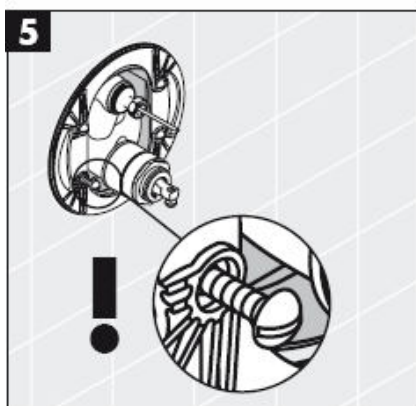
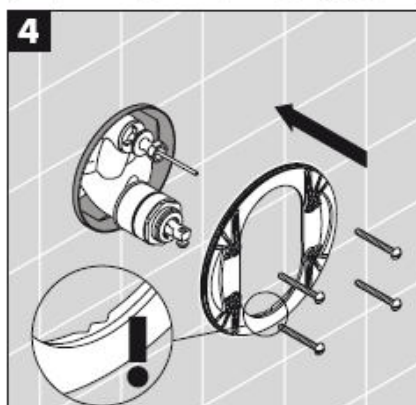
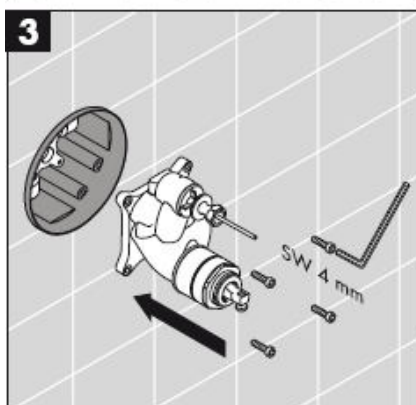
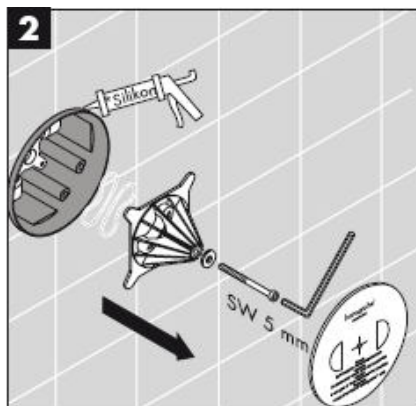
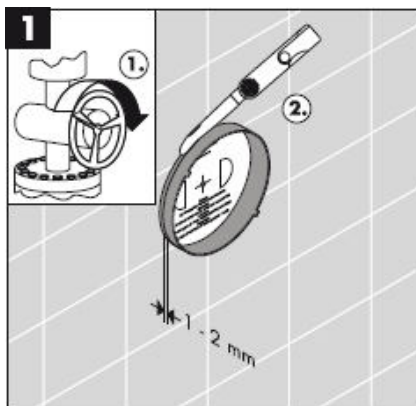

*硅胶（不含醋酸）

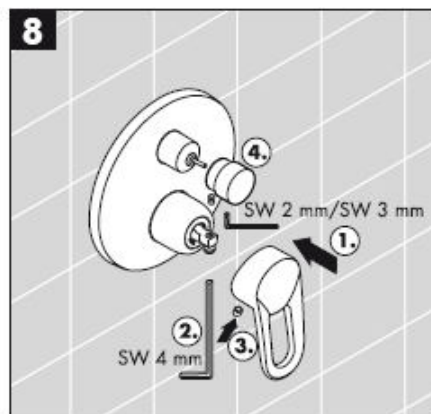
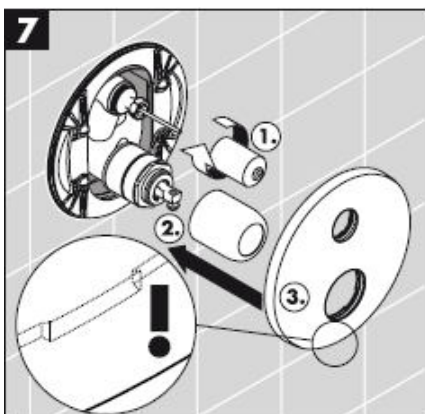

安装**注意！**

必须按照现行的规定安装，冲洗和测试产品！

操作

提起手柄，龙头开启。

向左 = 热水，向右 = 冷水

拉动水嘴上边的旋钮，从浴盆向花洒变更水流。

关闭水流后，龙头自动恢复浴盆功能。

技术参数

工作压力: max. 1 MPa

推荐工作压力: 0,1 – 0,5 MPa

测试压强: 1,6 MPa

(1 MPa = 10 巴 = 147 PSI)

热水温度: max. 80° C

推荐热水温度: 65° C

流速: 0,3 MPa

14475XXX / 14477XXX /

31475000 / 31476000 /

31744000 / 33455000 / 33457000:

出水口 浴缸 ca. 30 l/min

出水口 莲蓬头 ca. 24 l/min

14675XXX / 31675000 /

31761000 / 33665000: ca. 32 l/min

自动防止回流: 14477XXX

31476000

33457000

如果水压达到1.5巴以上，汉斯格雅单手柄龙头可以和液压式或热控式直流式热水器一起使用。

带有热水控制器的单手柄龙头的调节方法，参见第8页。

如果与连续流热水器一起使用，则不必作任何调节。

请勿将防热水层与水流加热器组合安装。

始终在浴缸上面安装ibox。如果ibox零件即将断裂，水可能从这里流出！

14477XXX/31476000/33457000安全装置每年必须检查一次。

单向阀必须在符合国家或当地的法律的情况下按照DIN EN 1717定期检查（至少一年一次）。

备用零件 参见第页 3

1	手柄 Metris E	31094XXX
1.1	螺钉帽	96338000
2	手柄 Focus E	31791000
3	手柄 Metropol E	14094XXX
4	手柄 Talis E	33091000
5	法兰	96453XXX
6	法兰	96452XXX
7	法兰 E	95010XXX
8	真空断路器	96753000
9	固定螺丝 (4)	96454000
10	底板	96447000
11	螺母	95007000
12	保险螺丝	96059000
13	单向阀	96655000
14	消音器	94073000
15	分水	95014000
16	阀体	92730000
17	套筒	96448000
18	提拉钮	95013XXX
19	加长件 25 mm	13595000
20	加长件 22 mm	13596000

XXX = 颜色代码

000 镀铬

090 铬/镀金

检验标记

	DVGW	P-IX	SVGW	NF	WRAS	KIWA
14475XXX	X	PA-IX 9709/ICC	X		X	
14477XXX		PA-IX 18097/IDC				
14675XXX	X	PA-IX 9710/IB	X		X	
31475000	X	PA-IX 9709/ICC	X		X	
31476000		PA-IX 18097/IDC				
31675000	X	PA-IX 9710/IB	X			
31744000	X	PA-IX 9709/IDC	X			
31761000	X	PA-IX 9710/IB	X		X	
33455000	X	PA-IX 9709/IDC	X	X	X	X
33457000	X	PA-IX 18097/IDC	X	X		
33655000	X	PA-IX 9710/IB	X	X		X

问题	原因	补救
龙头不灵活	-滤筒损坏, 结垢	-更换滤筒
龙头滴水	-滤筒损坏, 沉淀	-更换滤筒
分流器不工作	-水压过低 -分流器损坏	-增加水压 -更换分流器
热水温度过低, 没有冷水。选择冷水时, 热水器启动。	-热水控制器设置错误	-设置热水控制器
	-交叉流动	-更换滤筒

热水限制：热水温度60 C，冷水温度10 C，流动压力3巴

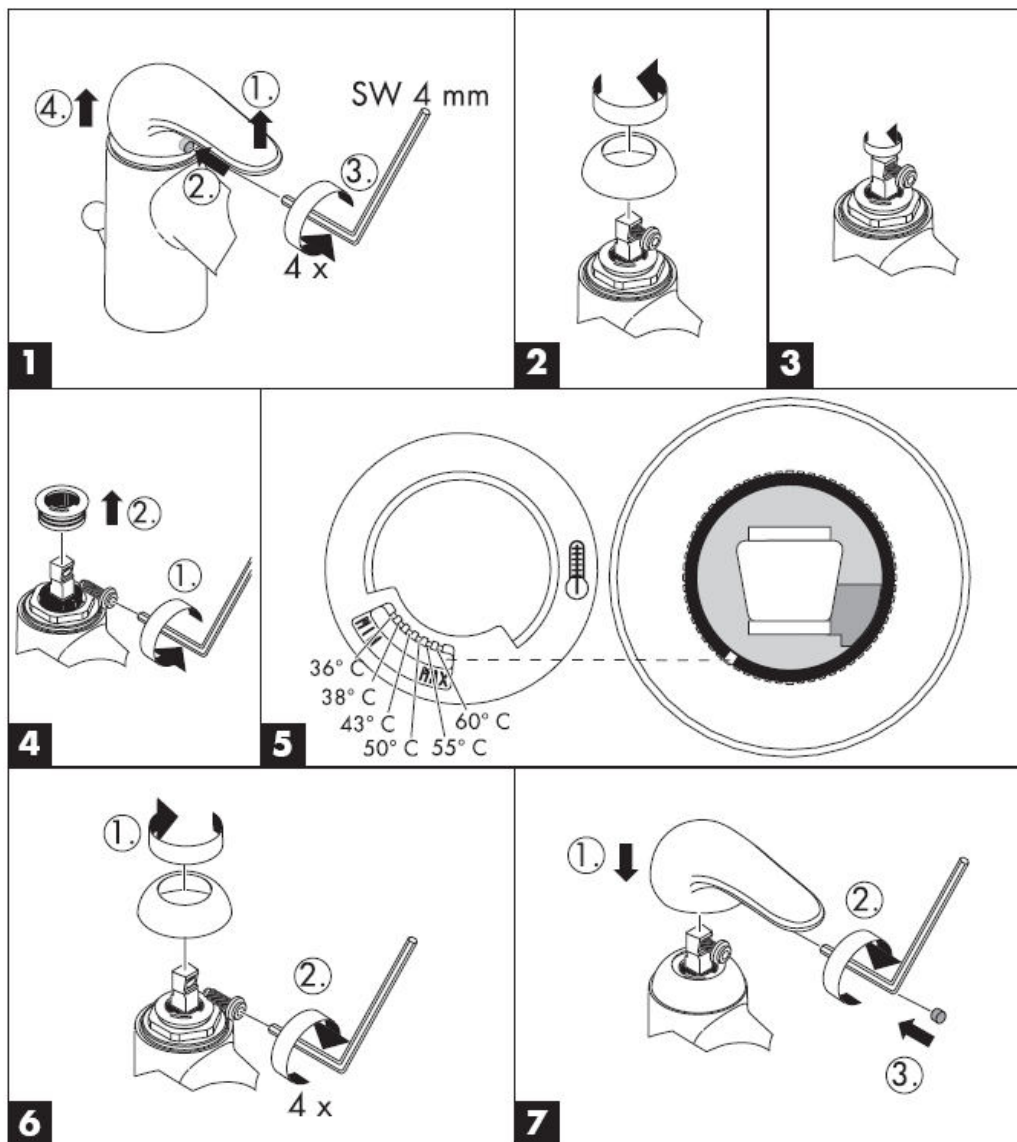

Инструкция по монтажу



Metropol E
14475XXX/
14477XXX



Metris E
31475000/
31476000



Focus E
31744000



Talis E
33455000/
33457000

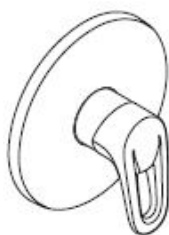

Metropol E
14675XXX



Metris E
31675000



Focus E
31761000



Talis E
33655000

hansgrohe

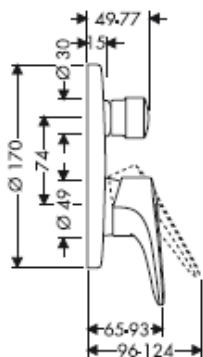
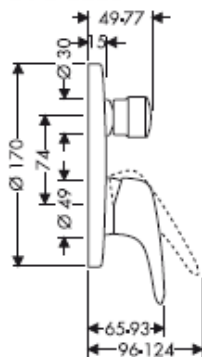
Metropol E14475XXX/
14477XXX**Metris E**31475000/
31476000**Focus E**

31744000

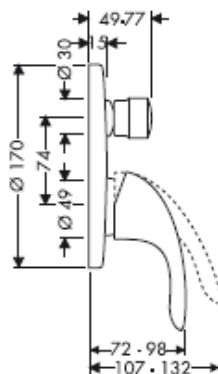
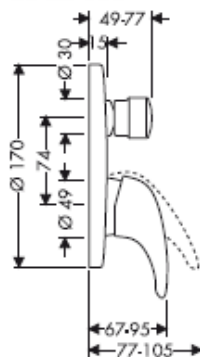
**Talis E**33455000/
33457000**Metropol E**

14675XXX

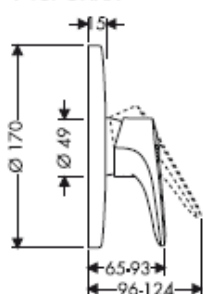
**Metris E**

31675000

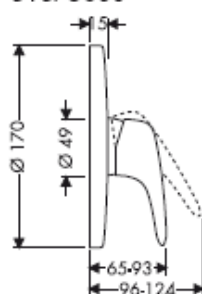
**Focus E**

31761000

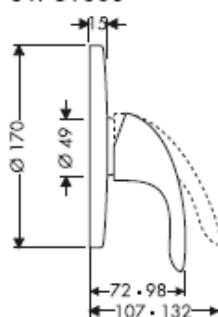
**Talis E**

33655000

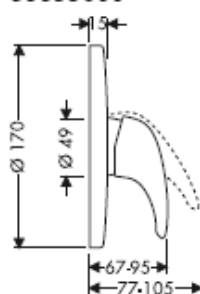

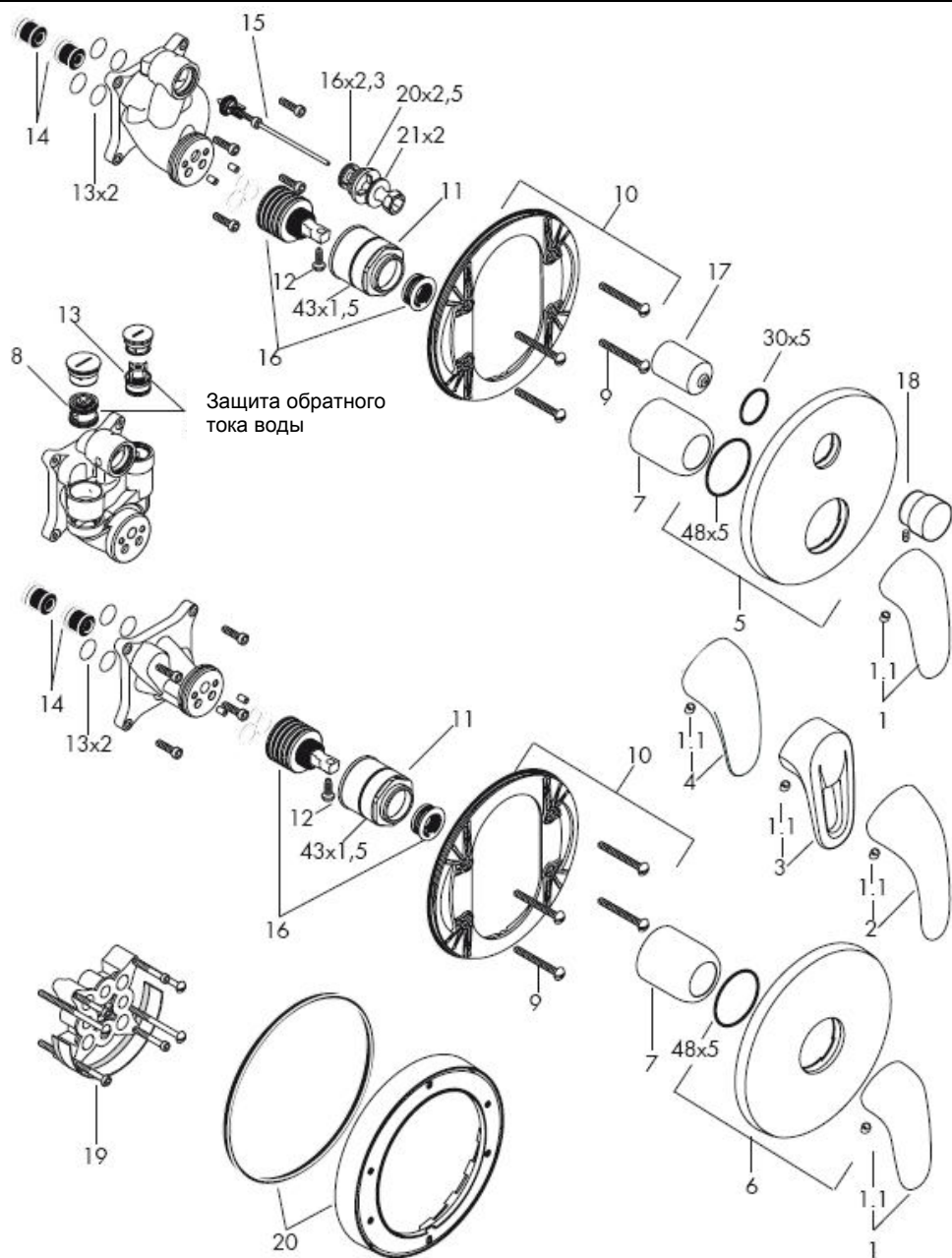

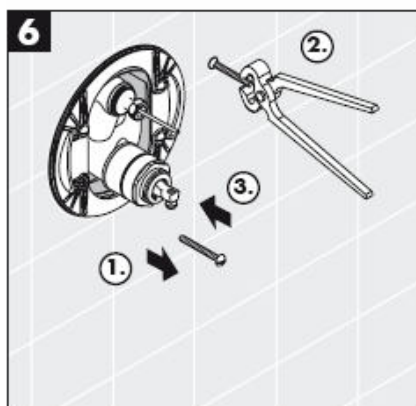
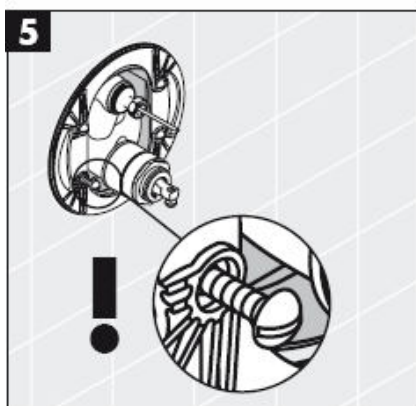
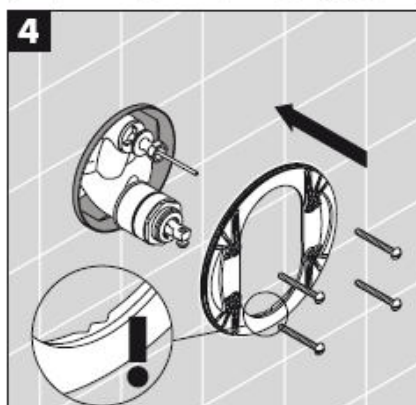
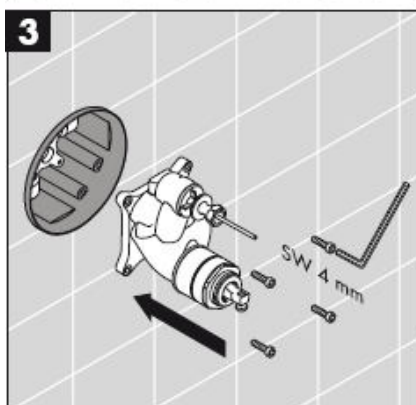
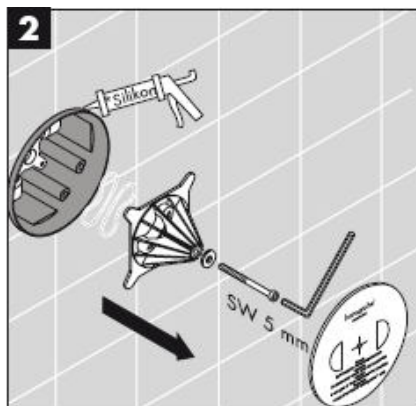
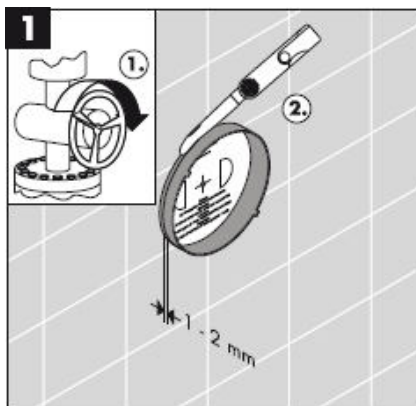

*Силикон (не содержит уксусной кислоты!)

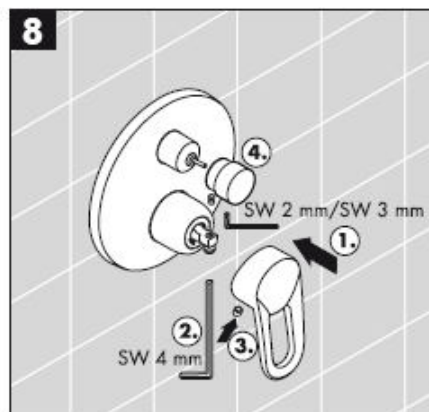
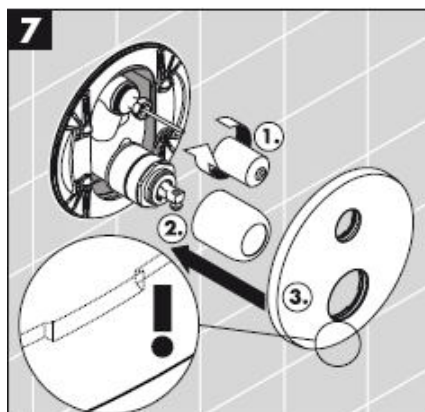

не разрешается установка блокировка горячей воды!

Монтаж

Осторожно! Смеситель должен быть смонтирован по действующим нормам и в соответствии с настоящей инструкцией, проверен на герметичность и безупречность работы

Эксплуатация

смеситель открывается поднятием рычага. Поворот рычага налево открывает горячую воду; Поворот влево = горячая вода, вправо = холодная вода. Переключение на ручной душ вытягиванием переключательной кнопки. Переключение в исходное положение осуществляется автоматически после закрытия рукоятки.

Технические данные

Рабочее давление:	max. 1 МПа
Рекомендуемое рабочее давление:	0,1 – 0,5 МПа
Давлении:	1,6 МПа
(1 МПа = 10 бар = 147 PSI)	
Температура горячей воды:	max. 80° C
Рекомендуемая темп. гор. воды:	65° C
Пропускная способность:	0,3 МПа
14475XXX / 14477XXX /	
31475000 / 31476000 /	
31744000 / 33455000 / 33457000:	
Выход поддон	ca. 30 l/min
Выход Душ	ca. 24 l/min
14675XXX / 31675000 /	
31761000 / 33665000:	
укомплектован клапаном обратного тока	ca. 32 l/min
воды:	14477XXX
	31476000
	33457000

Однорычажные смесители фирмы HANSGROHE можно использовать с электроводонагревателями бойлерного типа при минимальном давлении 0,15 МПа.

Однорычажный смеситель имеет ограничитель расхода горячей воды (см. Стр. 8: юстировка).

	3	Рукоятка Metropol E	14094XXX
	4	Рукоятка Talis E	33091000
Поскольку при неисправности функциональных деталей у iBox может выходить вода, iBox необходимо монтировать над ванной, чтобы выступающая вода могла стекать в ванну!	5	Розетка	96453XXX
	6	Розетка	96452XXX
	7	Шаровая розетка E	95010XXX
	8	Воздушник	96753000
	9	Винты кронштейна (4)	96454000
	10	несущие розетки	96447000
	11	Гайка	95007000
	12	Установочный винт	96059000
	13	Защита обратного тока воды	96655000
	14	глушитель шума	94073000
Устройства безопасности арматур 14477XXX/31476000/33457000 раз в году необходимо проверять на исправность работы.	15	Переключатель режима	95014000
	16	картридж	92730000
	17	Переключающая втулка	96448000
	18	Кнопка переключателя	95013XXX
	19	Удлинение 25 mm	13595000
	20	Удлинение 22 mm	13596000

Комплект см. стр. 3

1	Рукоятка Metris E	31094XXX
1.1	Пробка декоративная	96338000
2	Рукоятка Focus E	31791000

XXX = Код цвета поверхности

000	хром
090	хром/золото

Знак технического контроля

	DVGW	P-IX	SVGW	NF	WRAS	KIWA
14475XXX	X	PA-IX 9709/ICC	X		X	
14477XXX		PA-IX 18097/IDC				
14675XXX	X	PA-IX 9710/IB	X		X	
31475000	X	PA-IX 9709/ICC	X		X	
31476000		PA-IX 18097/IDC				
31675000	X	PA-IX 9710/IB	X			
31744000	X	PA-IX 9709/IDC	X			
31761000	X	PA-IX 9710/IB	X		X	
33455000	X	PA-IX 9709/IDC	X	X	X	X
33457000	X	PA-IX 18097/IDC	X	X		
33655000	X	PA-IX 9710/IB	X	X		X

Неисправность	Причина	Устранение неисправности
Арматура работает с усилием	-Картридж неисправен, засорение накипью	-Замените картридж
Арматура протекает	-Картридж неисправен, отложения	-Замените картридж
Переключатель не работает	-Слишком малое давление воды -Переключатель неисправен	-Увеличьте давление воды -Замените переключатель
Слишком низкая температура горячей воды. Проточный нагреватель запускается при выборе холодной воды.	-Ограничение горячей воды отрегулировано неправильно -Перекрестный поток	-Отрегулируйте ограничение горячей воды -Замените картридж

Ограничение расхода горячей воды: температура горячей воды 60 C, температура холодной воды 10 C, давление 0,3 МПа.

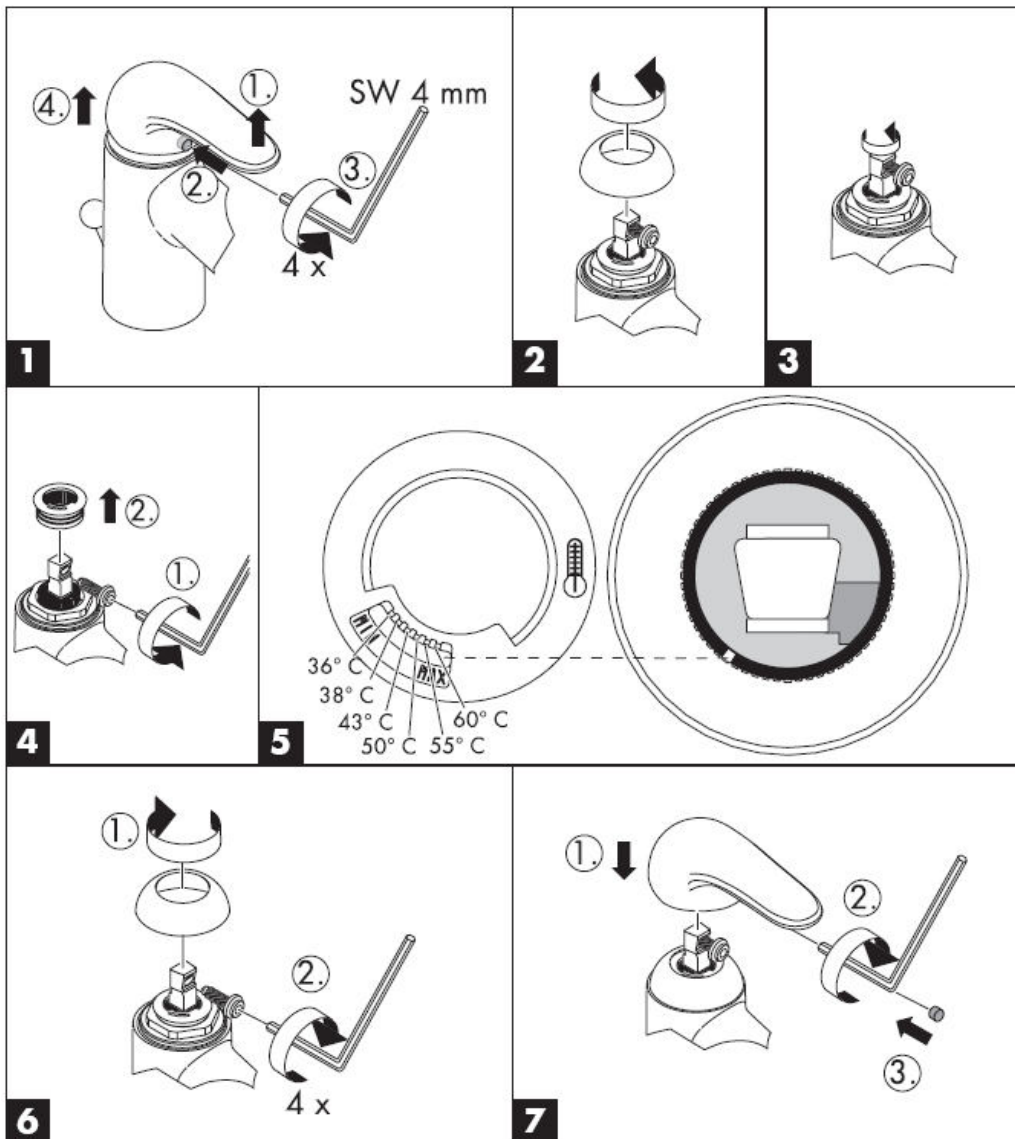

Szerelési útmutató



Metropol E
14475XXX/
14477XXX



Metris E
31475000/
31476000



Focus E
31744000



Talis E
33455000/
33457000



Metropol E
14675XXX



Metris E
31675000



Focus E
31761000



Talis E
33655000

hansgrohe

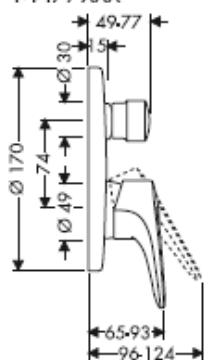
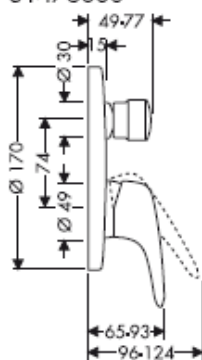
Metropol E14475XXX/
14477XXX**Metris E**31475000/
31476000**Focus E**

31744000

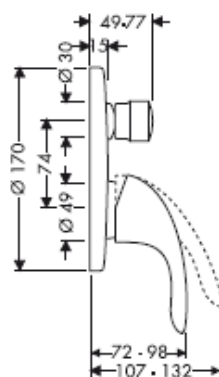
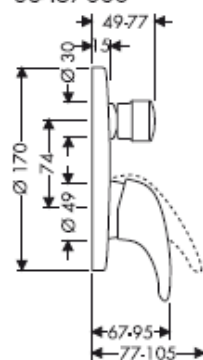
**Talis E**33455000/
33457000**Metropol E**

14675XXX

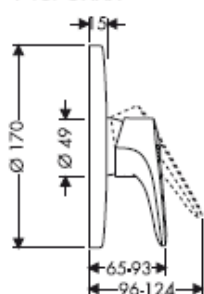
**Metris E**

31675000

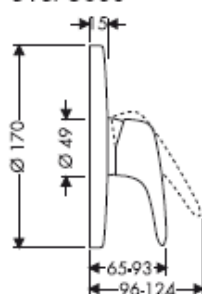
**Focus E**

31761000

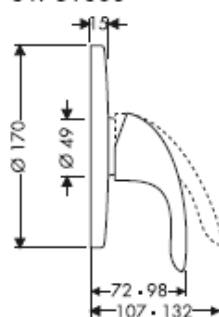
**Talis E**

33655000

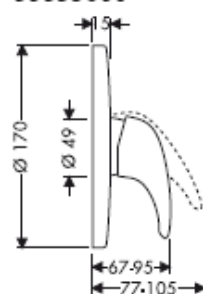

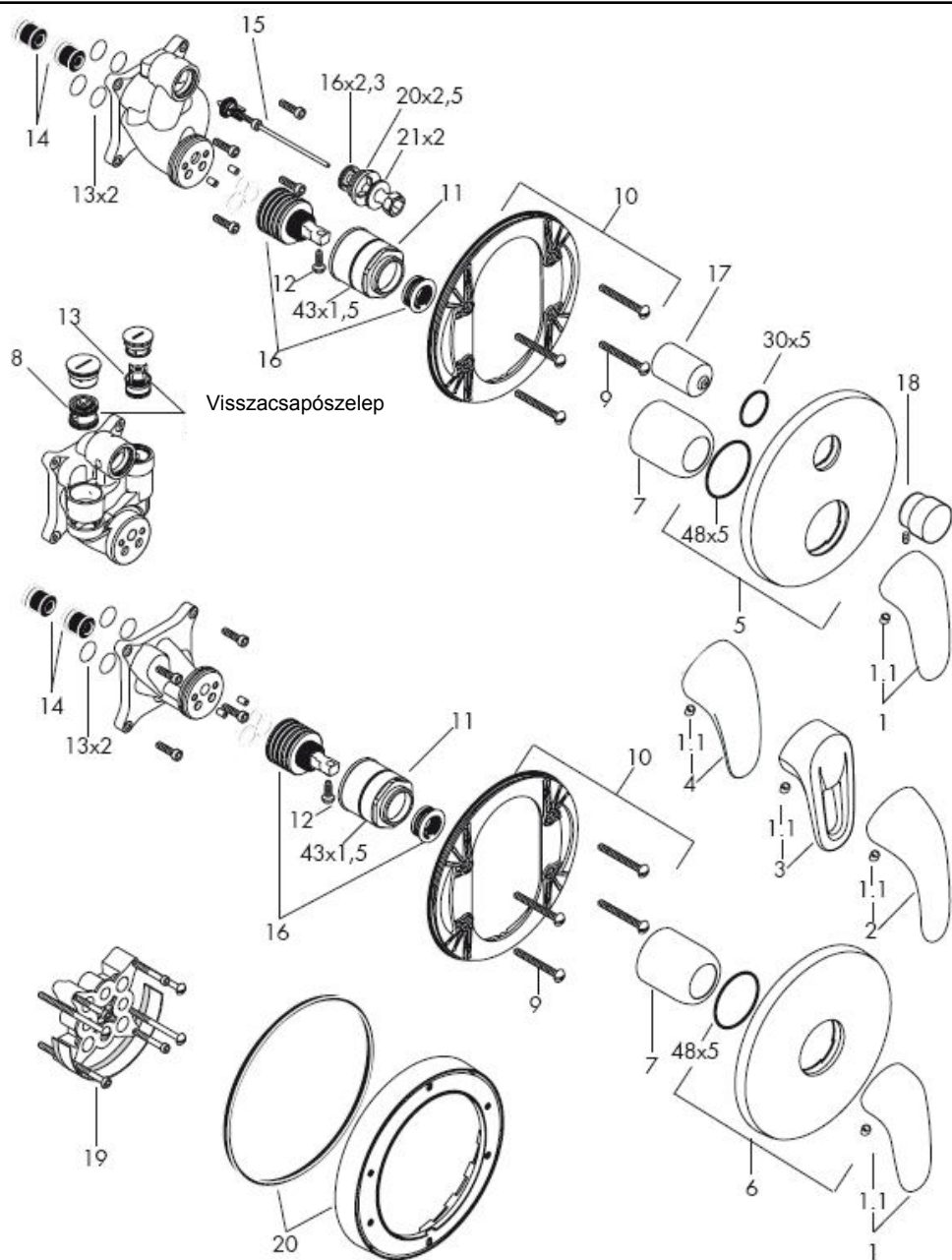

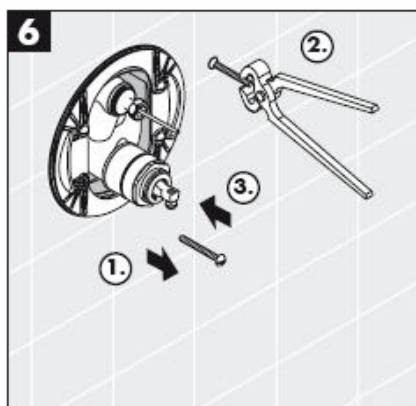
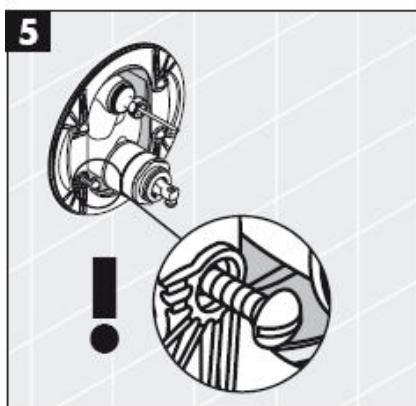
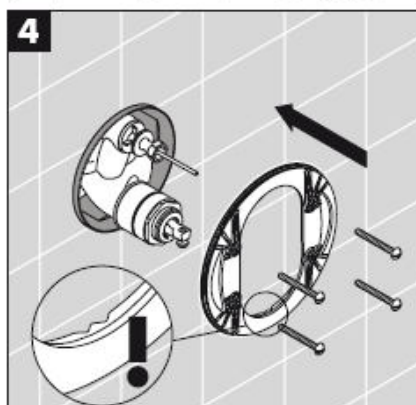
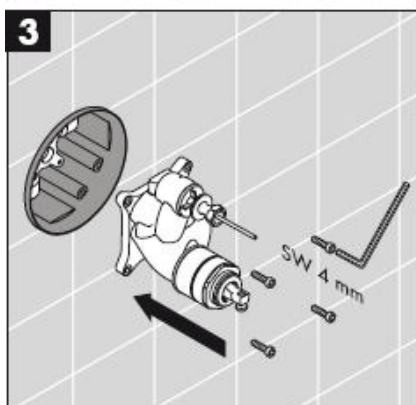
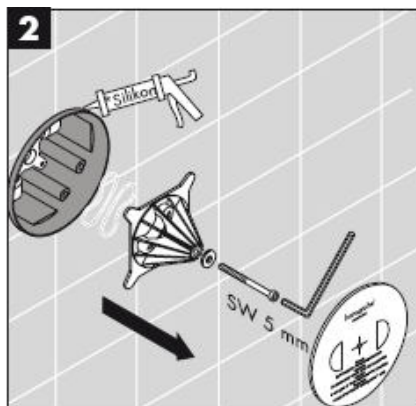
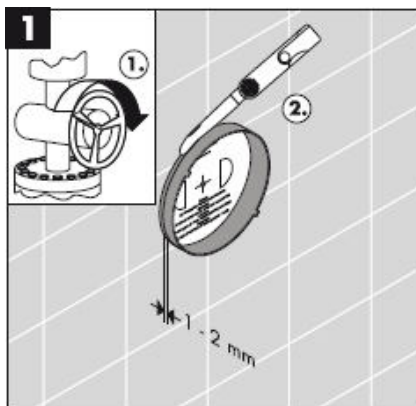

*Szilikon (ecetsavmentes!)

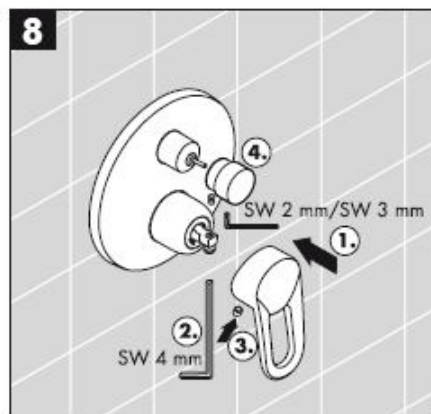
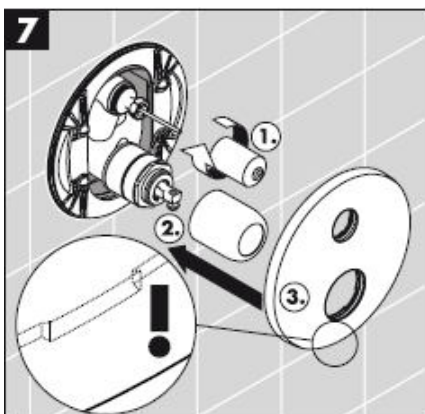

Szerelés

Figyelem! A csaptelepet az érvényben lévő előírásoknak megfelelően kell felszerelni, átöblíteni és ellenőrizni!

Használat

A keverőcsapot a fogantyú emelésével nyitjuk ki. Balra fordítás = meleg víz, jobbra = hideg víz. A kézi zuhanyra történő átállítás az átállítógomb húzásával történik. A visszaállítás a fogantyú elzárása után automatikusan bekövetkezik.

Műszaki adatok

Üzemi nyomás:	max. 1 MPa
Ajánlott üzemi nyomás:	0,1 – 0,5 MPa
Nyomáspróba:	1,6 MPa
(1 MPa = 10 bar = 147 PSI)	
Forróvíz hőmérséklet:	max. 80° C
Forróvíz javasolt hőmérséklete:	65° C
Átfolyási teljesítmény : 0,3 MPa	
14475XXX / 14477XXX /	
31475000 / 31476000 /	
31744000 / 33455000 / 33457000:	
Kifolyó kád	ca. 30 l/min
Kifolyó Zuhany	ca. 24 l/min
14675XXX / 31675000 /	
31761000 / 33665000:	ca. 32 l/min
Visszafolyás gátlóval:	14477XXX
	31476000
	33457000

A Hansgrohe egykaros keverő csaptelepek beépíthetők hidraulikus- és hőszabályozással ellátott átfolyós vízmelegítőknél egyaránt, ha a víznyomás legalább 0,15 MPa.

Az egykaros, melegvíz-korlátozóval ellátott keverő csaptelep beállítását lásd a 8. oldalon. Az átfolyó rendszerű vízmelegítőknél nem szükséges a melegvíz-korlátozó.

Átfolyós melegítővel kapcsolatban nem szabad melegvíz-gátlót beépíteni!

Mivel a működő részek meghibásodásakor víz kerülhet az ibox-ra, ezért az ibox-ot a kád fölé kell felszerelni, hogy a kifolyó víz a kádba folyhasson!

A csaptelep 14477XXX/31476000/33457000 biztonsági berendezéseinek működését évente egyszer ellenőrizni kell.

A visszafolyásgátlók működése a DIN EN 1717 szabványnak megfelelően, a nemzeti vagy területi rendelkezésekkel összhangban, évente egyszer ellenőrizendő!

Tartozékok lásd a oldalon 3

1	Fogantyú Metris E	31094XXX
1.1	Takaródugó a csavarhoz	96338000
2	Fogantyú Focus E	31791000
3	Fogantyú Metropol E	14094XXX
4	FogantyúTalis E	33091000
5	Rozetta	96453XXX
6	Rozetta	96452XXX
7	Golyórozetta E	95010XXX
8	Csőszellőztető	96753000
9	Tartócsavarok (4)	96454000
10	Tartórozetta	96447000
11	Anyá	95007000
12	sróf	96059000
13	Visszacsapószelep	96655000
14	Hangszigetelő	94073000
15	kádváltó szelep (kompl.)	95014000
16	Betét	92730000
17	Átállítóhüvely	96448000
18	kádváltó szelep gomb	95013XXX
19	Hosszabbítás 25 mm	13595000
20	Hosszabbítás 22 mm	13596000

XXX = Színkódok

000	króm
090	króm/arany

Magyar

Vizsgajel

	DVGW	P-IX	SVGW	NF	WRAS	KIWA
14475XXX	X	PA-IX 9709/ICC	X		X	
14477XXX		PA-IX 18097/IDC				
14675XXX	X	PA-IX 9710/IB	X		X	
31475000	X	PA-IX 9709/ICC	X		X	
31476000		PA-IX 18097/IDC				
31675000	X	PA-IX 9710/IB	X			
31744000	X	PA-IX 9709/IDC	X			
31761000	X	PA-IX 9710/IB	X		X	
33455000	X	PA-IX 9709/IDC	X	X	X	X
33457000	X	PA-IX 18097/IDC	X	X		
33655000	X	PA-IX 9710/IB	X	X		X

Hiba	Ok	Megoldás
Nehezen nyitható a csap.	-A kerámiabetét meghibásodott, elvízkövesedett.	-A kerámiabetétet ki kell cserélni.
Csöpög a csap.	-A kerámiabetét meghibásodott, lerakódások	-A kerámiabetétet ki kell cserélni.
0	-Túl kicsi víznyomás -A kádváltó szelep hibás	-Növelje a víznyomást -Az átállító cseréje
Túl alacsony melegvíz hőmérséklet, nincs hidegvíz. A hidegvíz kiválasztásakor beindul az átfolyós melegítő.	-A melegvíz szabályozó rosszul van beállítva. -Keresztfolyás	-A melegvíz szabályozót újra be kell állítani. -A kerámiabetétet ki kell cserélni.

Melegvíz-korlátozás: melegvíz-hőmérséklet 60 C, hidegvíz-hőmérséklet 10 C, víznyomás 0,3 MPa.

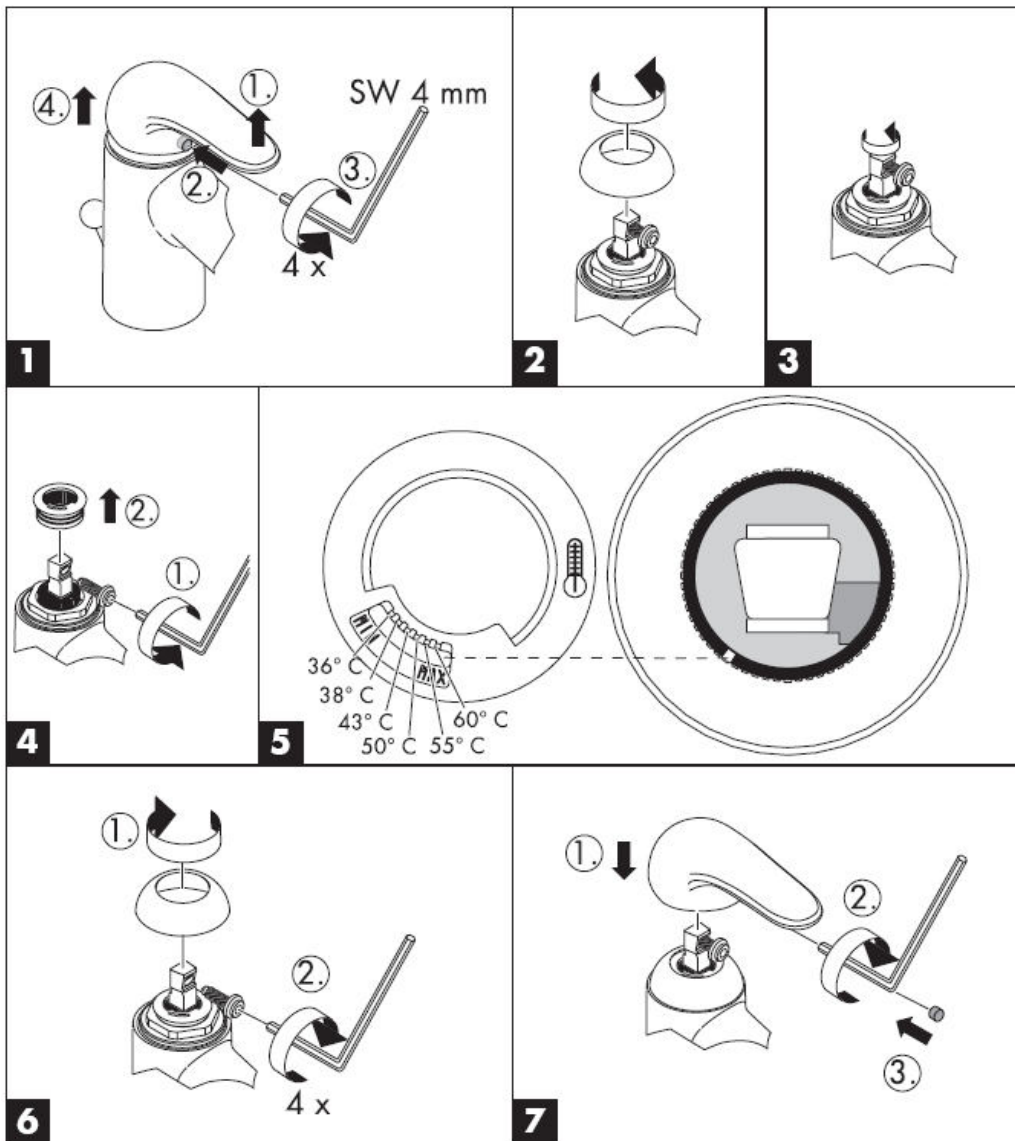

Asennusohje



Metropol E
14475XXX/
14477XXX



Metris E
31475000/
31476000



Focus E
31744000



Talis E
33455000/
33457000



Metropol E
14675XXX



Metris E
31675000



Focus E
31761000



Talis E
33655000

hansgrohe

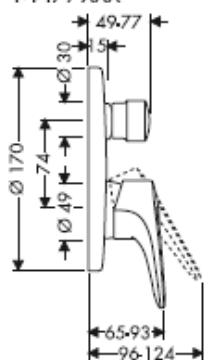
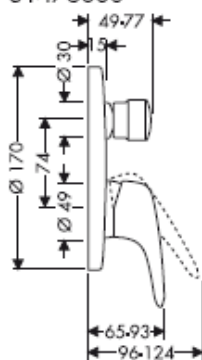
Metropol E14475XXX/
14477XXX**Metris E**31475000/
31476000**Focus E**

31744000

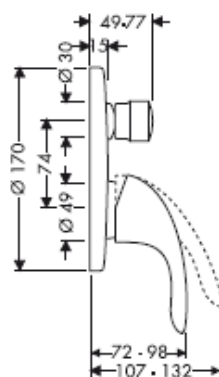
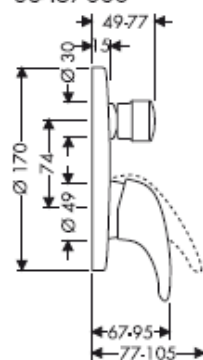
**Talis E**33455000/
33457000**Metropol E**

14675XXX

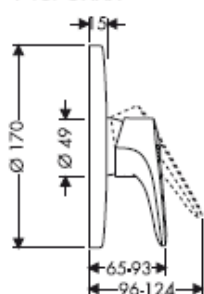
**Metris E**

31675000

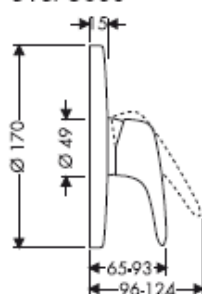
**Focus E**

31761000

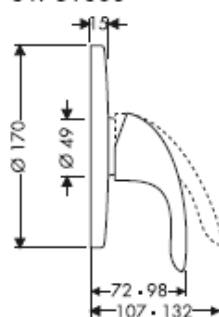
**Talis E**

33655000

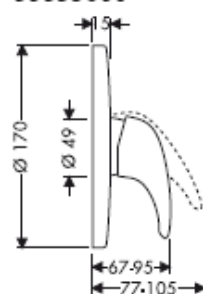

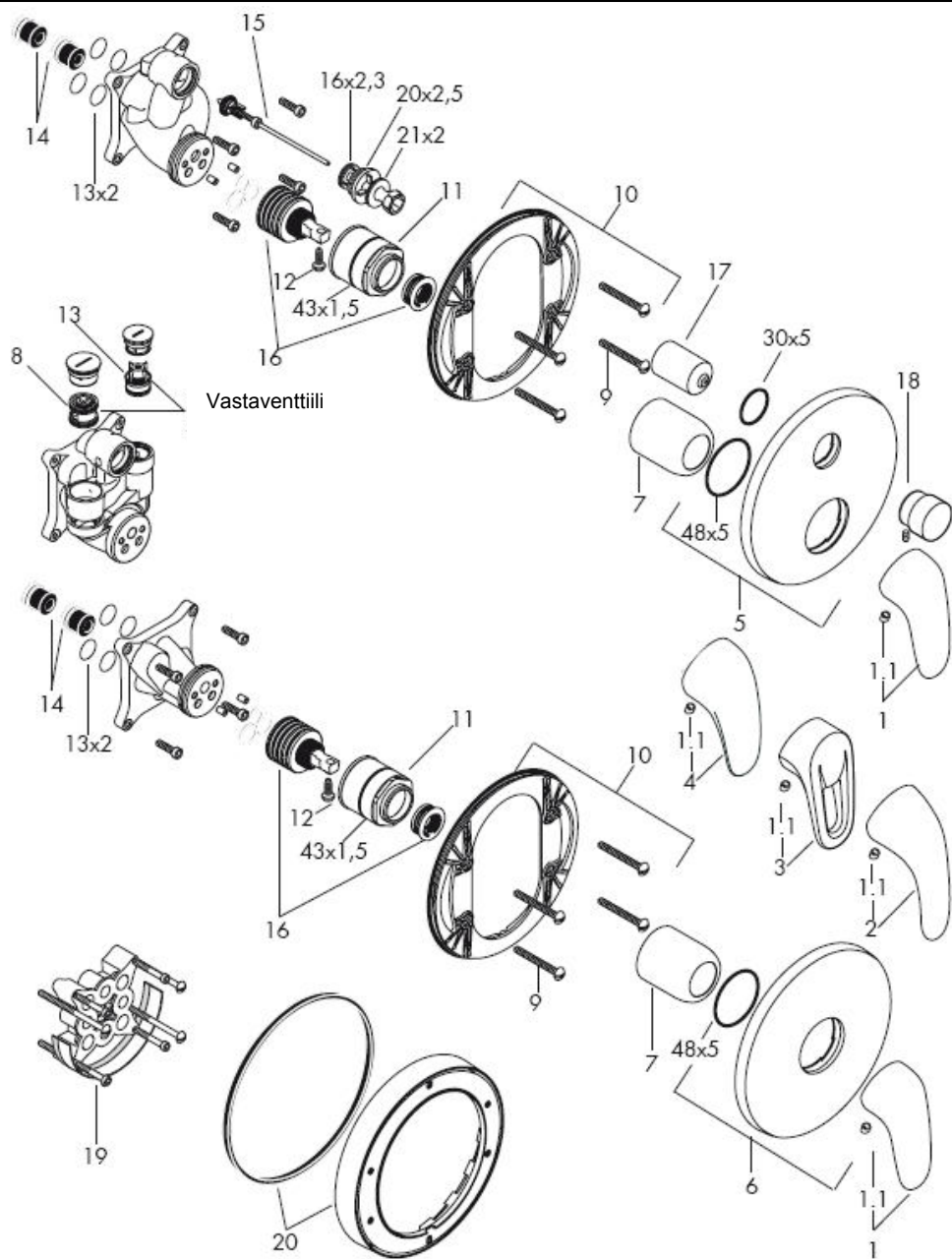

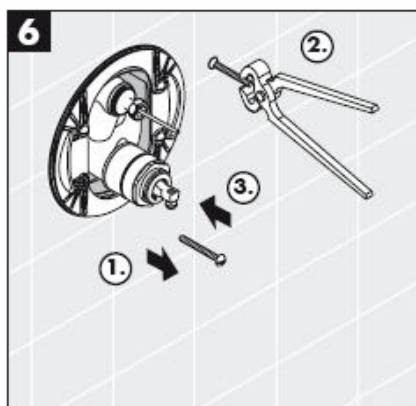
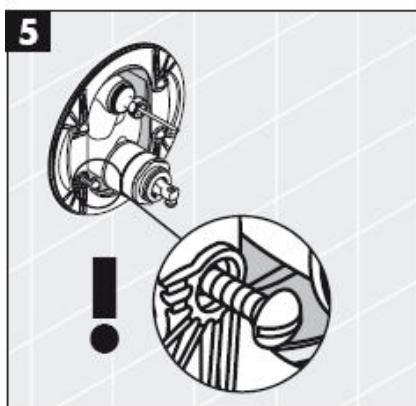
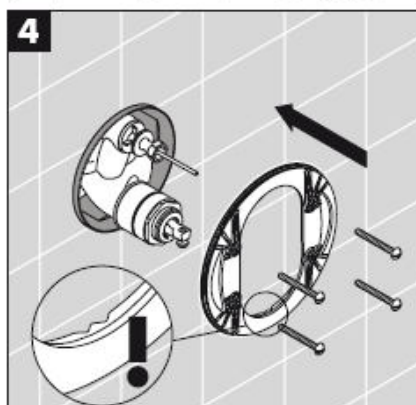
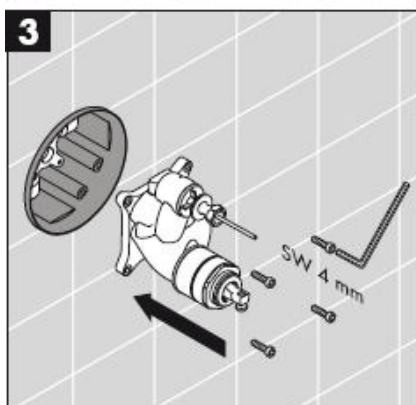
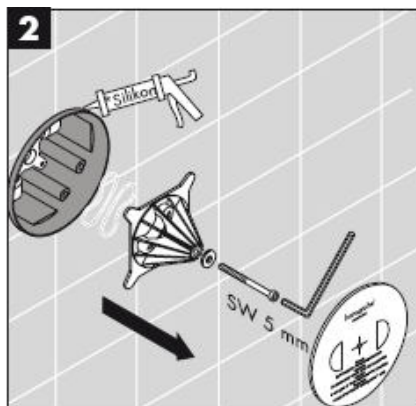
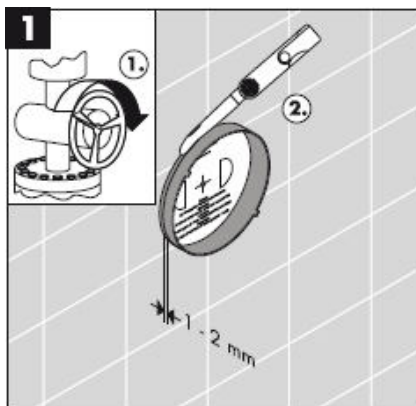

*Silikoni (etikkahappovapaa!)

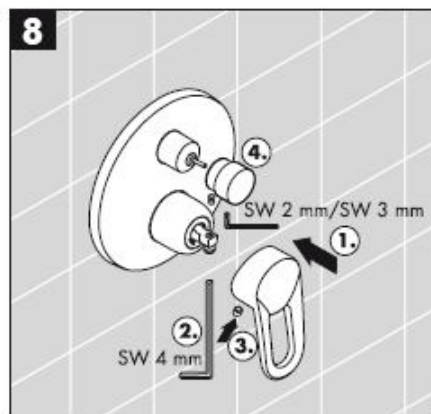
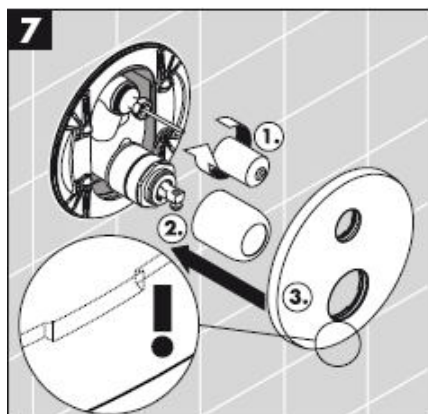

Asennus

Huomio! Kaluste on asennettava, huuhdeltava ja tarkastettava voimassa olevien määräysten mukaisesti!

Käyttö

Sekoittaja avautuu kahvasta vetämällä. Kääntö vasemmalle = kylmä vesi, oikealle = kuuma vesi. Käsisuihkulle vaihtaminen tehdään vaihtonupista vetämällä. Palautus tapahtuu automaattisesti kahvan sulkemisen jälkeen.

Tekniset tiedot

Käyttöpaine:	max. 1 MPa
Suositteltu käyttöpaine:	0,1 – 0,5 MPa
Koestuspaine:	1,6 MPa
(1 MPa = 10 bar = 147 PSI)	
Kuuman veden lämpötila:	max. 80° C
Kuuman veden suosituslämpötila:	65° C
Läpivirtausmäärä: 0,3 MPa	
14475XXX / 14477XXX /	
31475000 / 31476000 /	
31744000 / 33455000 / 33457000:	
Lähtö Amme	ca. 30 l/min
Lähtö Suihku	ca. 24 l/min
14675XXX / 31675000 /	
31761000 / 33665000:	ca. 32 l/min
Estää itsestään paluuvirtauksen:	14477XXX
	31476000
	33457000

Hansgrohe yksivipuisia sekoittimia voi käyttää hydraulisesti tai termisesti ohjattujen läpivirtauskuumentimien yhteydessä, jos virtauspaine on vähintään 0,15 MPa.

Yksivipuinen sekoittaja lämpimän veden rajoituksella, katso säätö sivulta 8. Lämpimän veden rajoitusta ei tarvita läpivirtauskuumentimien yhteydessä.

Lämminvesirajoitinta ei saa käyttää läpivirtauskuumentimien yhteydessä!

Koska ibox:ista voi valua vettä toimintaosien vahingoittuessa, ibox on asennettava ammeen yläpuolelle, jotta valuva vesi pääsee valumaan ammeeseen!

Kalusteiden 14477XXX/31476000/33457000 turvalaitteiden toiminta on tarkastettava vuosittain.

Vastaventtiilien toiminta on tarkastettava säännöllisesti paikallisten ja kansallisten määräysten mukaisesti (DIN 1988, kerran vuodessa).

Varaosat katso sivu 3

1	Kahva Metris E	31094XXX
1.1	Kahvatulppa	96338000
2	Kahva Focus E	31791000
3	Kahva Metropol E	14094XXX
4	KahvaTalis E	33091000
5	Peitekaulus	96453XXX
6	Peitekaulus	96452XXX
7	Kuulapeiterengas E	95010XXX
8	Putken tuuletusventtiili	96753000
9	Kannatusruuvit (4)	96454000
10	Kannatuspeiterengas	96447000
11	Mutteri	95007000
12	Lukitusruuvi	96059000
13	Vastaventtiili	96655000
14	Äänenvaimennin	94073000
15	Vaihtoventtiili, täydellinen	95014000
16	Panos, täydellinen	92730000
17	Vaihtoventtiilin holkki	96448000
18	Vetonuppi	95013XXX
19	Pidennys 25 mm	13595000
20	Pidennys 22 mm	13596000

XXX = Värikoodi

000 kromi
090 kromi/kulta

Suomi

Koestusmerkki

	DVGW	P-IX	SVGW	NF	WRAS	KIWA
14475XXX	X	PA-IX 9709/ICC	X		X	
14477XXX		PA-IX 18097/IDC				
14675XXX	X	PA-IX 9710/IB	X		X	
31475000	X	PA-IX 9709/ICC	X		X	
31476000		PA-IX 18097/IDC				
31675000	X	PA-IX 9710/IB	X			
31744000	X	PA-IX 9709/IDC	X			
31761000	X	PA-IX 9710/IB	X		X	
33455000	X	PA-IX 9709/IDC	X	X	X	X
33457000	X	PA-IX 18097/IDC	X	X		
33655000	X	PA-IX 9710/IB	X	X		X

Häiriö	Syy	Toimenpide
Hana on raskaskäyttöinen	-Patruuna rikki, kalkkikerrostumia	-Vaihda patruuna
Hanasta tippuu vettä	-Patruuna rikki, kerrostumia	-Vaihda patruuna
Valitsin ei toimi	-Liian matala vedenpaine -Valitsin rikki	-Lisää vedenpainetta -Vaihda valitsin
Lämminveden lämpötila liian alhainen, ei kylmää vettä.	-Lämminveden rajoitin väärin säädetty	-Säädä lämminveden rajoitin
Läpivirtauskuumennin käynnistyy kylmää vettä otettaessa.	-Ristiinvirtaus	-Vaihda patruuna

Kuumanveden rajoitin: kuuman veden lämpötila 60 C, kylmän veden lämpötila 10 C, virtauspaine 0,3 MPa.

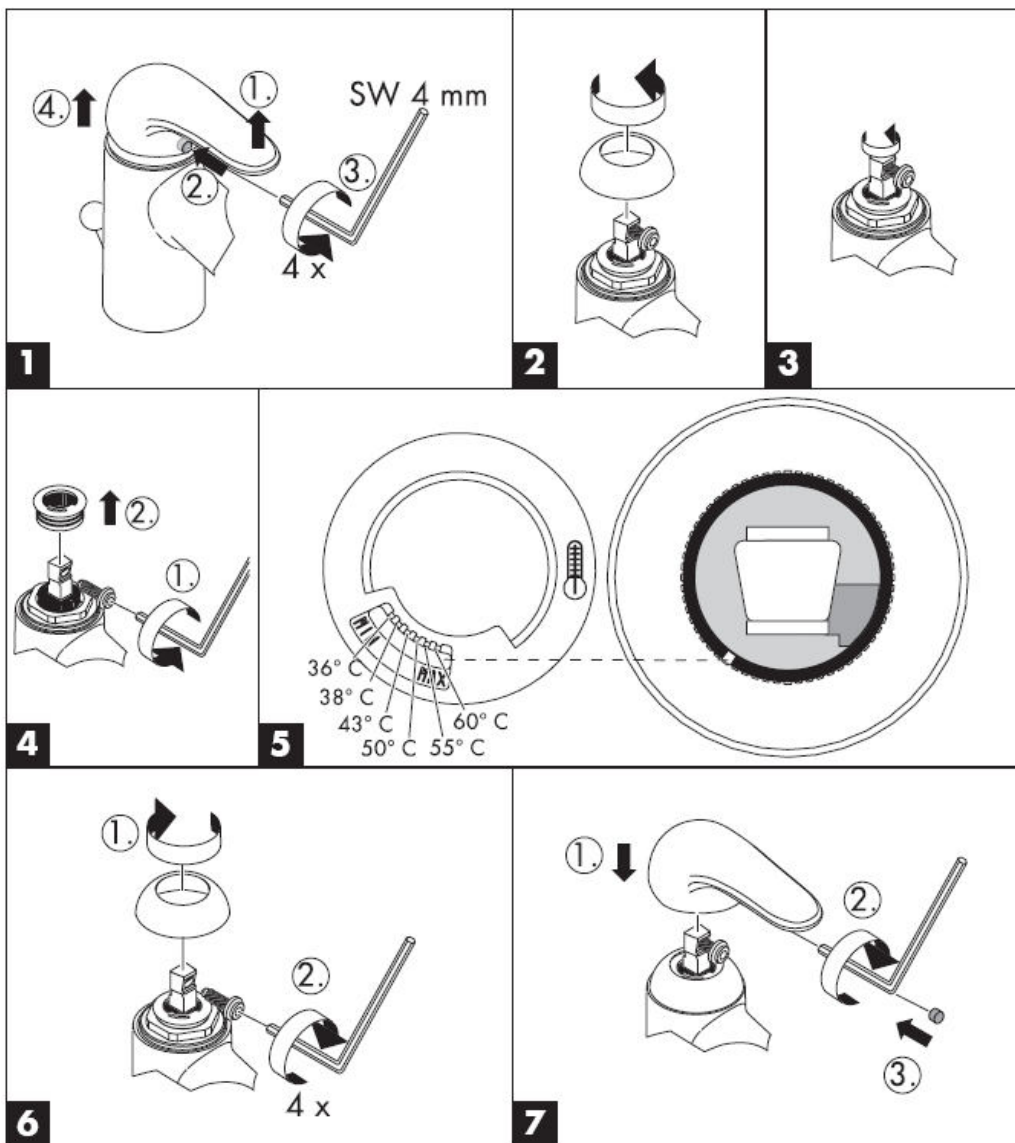

Hansgrohe

Monteringsanvisning



Metropol E
14475XXX/
14477XXX



Metris E
31475000/
31476000



Focus E
31744000



Talis E
33455000/
33457000



Metropol E
14675XXX



Metris E
31675000



Focus E
31761000



Talis E
33655000

hangrohe

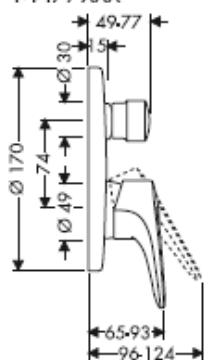
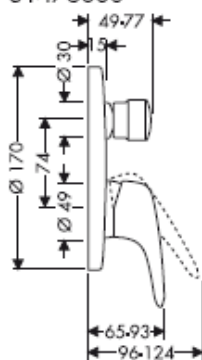
Metropol E14475XXX/
14477XXX**Metris E**31475000/
31476000**Focus E**

31744000

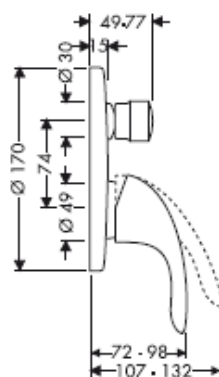
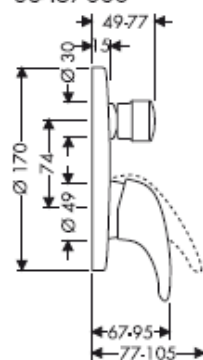
**Talis E**33455000/
33457000**Metropol E**

14675XXX

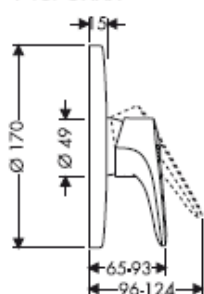
**Metris E**

31675000

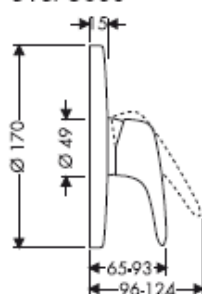
**Focus E**

31761000

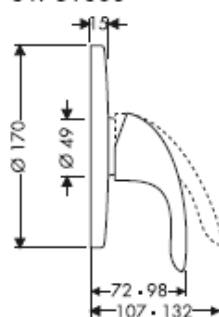
**Talis E**

33655000

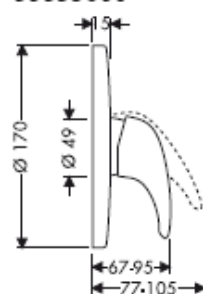

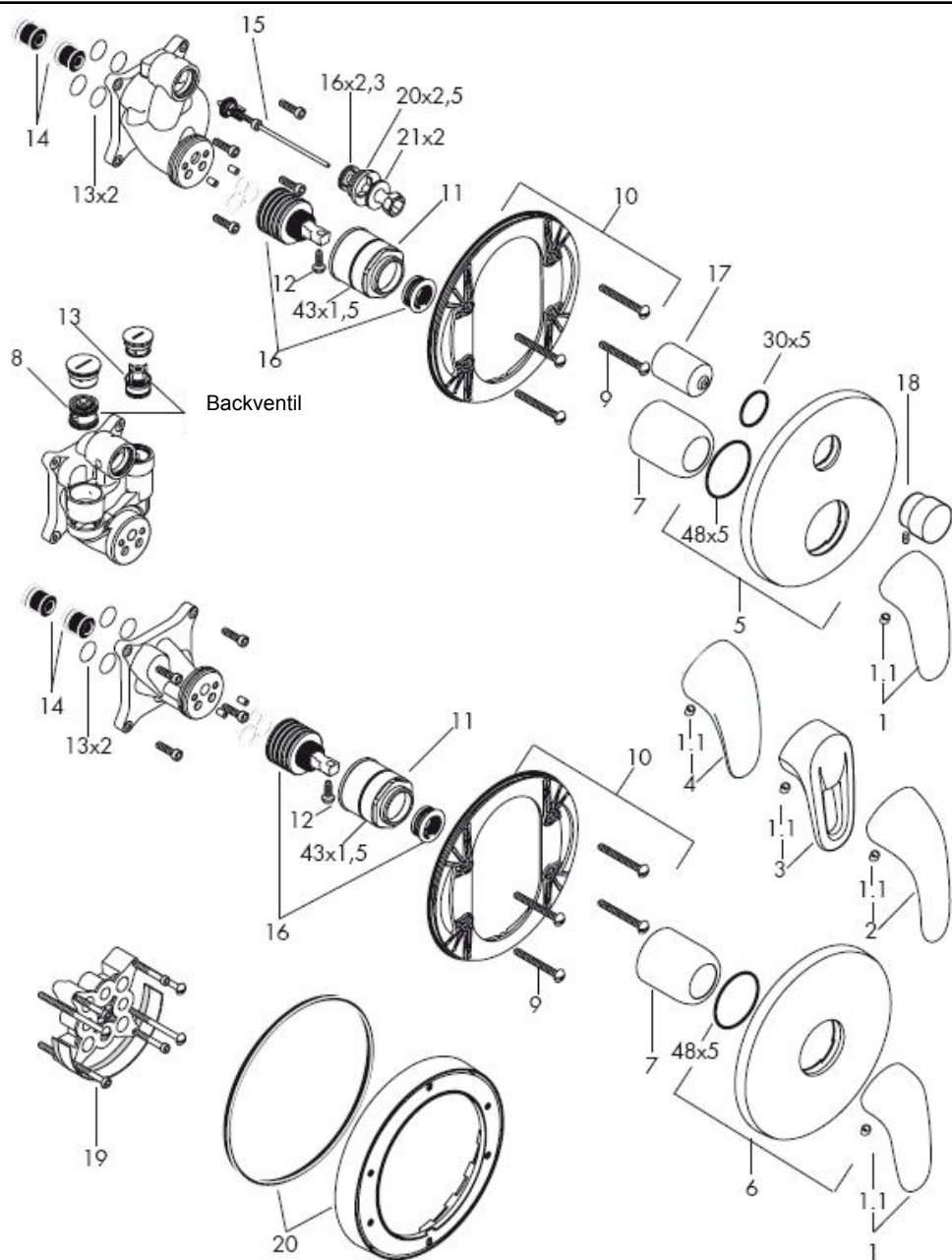

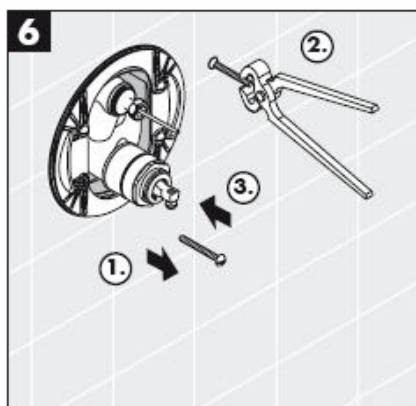
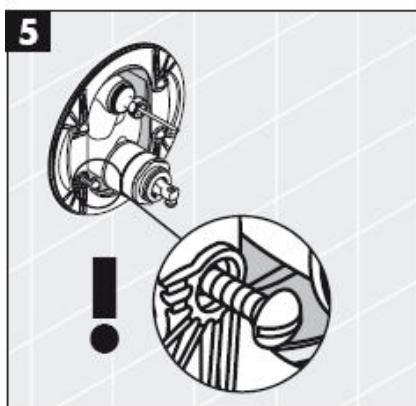
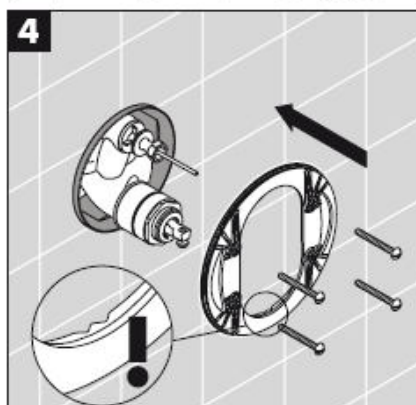
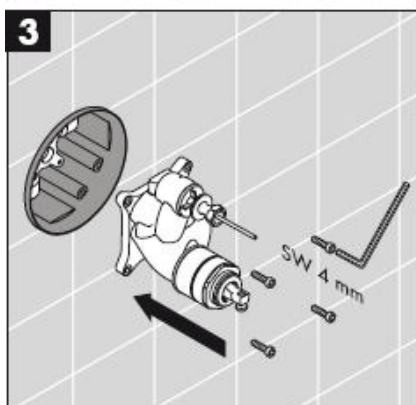
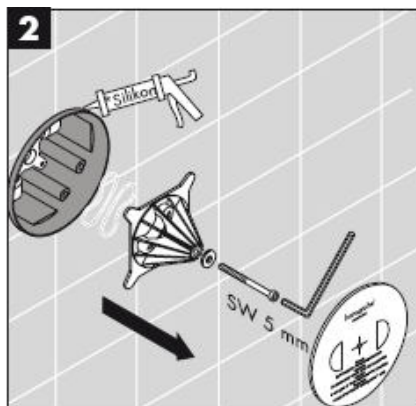
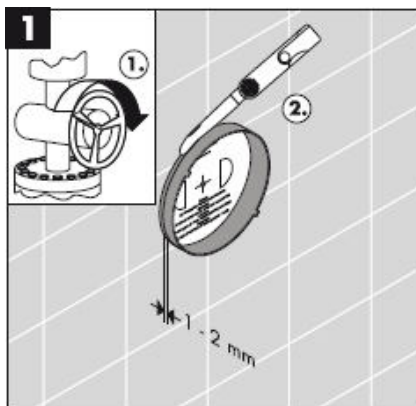

*Silikon (fri från ättiksyra!)

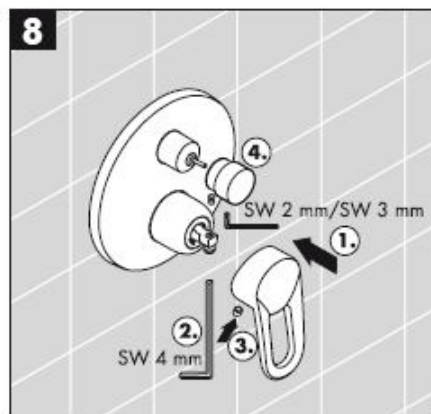
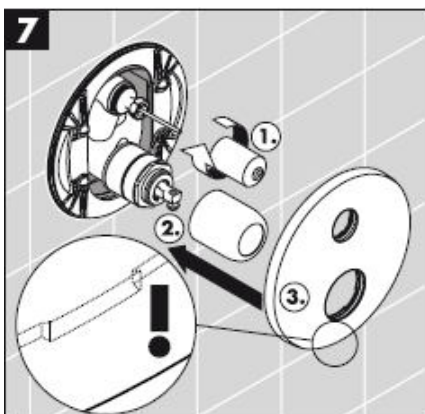

Montering

OBS! Blandaren måste installeras, genomspolas och testas enligt gällande föreskrifter.

Hantering

När man drar i greppet öppnas blandaren. Svängning åt vänster = varmt vatten, åt höger = kallt vatten.

Man ställer om till handdusch genom att dra i omställningsknappen. Återställningen sker automatiskt när greppet har stängts.

Tekniska data

Driftstryck:	max. 1 MPa
Rek. driftstryck:	0,1 – 0,5 MPa
Tryck vid provtryckning: (1 MPa = 10 bar = 147 PSI)	1,6 MPa
Varmvattentemperatur:	max. 80° C
Rek. varmvattentemp.:	65° C
Genomströmningmängd: 0,3 MPa 14475XXX / 14477XXX / 31475000 / 31476000 / 31744000 / 33455000 / 33457000:	
Avlopp Kar	ca. 30 l/min
Avlopp Dusch 14675XXX / 31675000 / 31761000 / 33665000:	ca. 24 l/min
Självspärr mot återflöde:	ca. 32 l/min 14477XXX 31476000 33457000

Hansgrohe enhandsblandare kan användas tillsammans med hydrauliskt och termiskt styrda varmvattenberedare när flödestrycket uppgår till minst 0,15 MPa.

Enhandsblandare med varmvattenreglering, justering se sidan 8. Vid användning tillsammans med varmvattenberedare behövs ingen varmvattenreglering.

Varmvattenreglering får inte användas tillsammans med varmvattenberedare!

Eftersom vatten kan tränga ut vid iboxen om funktionsdelar är defekta så måste iboxen monteras över karet så att det vatten som kommer ut kan rinna ner i karet!

Säkerhetsfunktionerna hos blandarna 14477XXX/31476000/33457000 måste kontrolleras en gång per år.

Backventilers funktion måste kontrolleras regelbundet enligt nationella eller regionala bestämmelser (DIN 1988 en gång per år) i enlighet med DIN EN 1717.

Reservdelar se sidan 3

1	Grepp Metris E	31094XXX
1.1	Greppstopp	96338000
2	Grepp Focus E	31791000
3	Grepp Metropol E	14094XXX
4	GreppTalis E	33091000
5	Rosett	96453XXX
6	Rosett	96452XXX
7	Kulrossett E	95010XXX
8	Vakuumventil	96753000
9	Stödskrivar (4)	96454000
10	Stödrossett	96447000
11	Mutter	95007000
12	Låsskruv	96059000
13	Backventil	96655000
14	Ljuddämpare	94073000
15	Omställare kompl.	95014000
16	Patron kompl.	92730000
17	Omställningshylsa	96448000
18	Dragknapp	95013XXX
19	(testinlopp stängt - blandare öppnad) (bild 3) 25 mm	13595000
20	(testinlopp stängt - blandare öppnad) (bild 3) 22 mm	13596000

XXX = Färgkodning

000

090 krom/guld

Svenska

Testsigill

	DVGW	P-IX	SVGW	NF	WRAS	KIWA
14475XXX	X	PA-IX 9709/ICC	X		X	
14477XXX		PA-IX 18097/IDC				
14675XXX	X	PA-IX 9710/IB	X		X	
31475000	X	PA-IX 9709/ICC	X		X	
31476000		PA-IX 18097/IDC				
31675000	X	PA-IX 9710/IB	X			
31744000	X	PA-IX 9709/IDC	X			
31761000	X	PA-IX 9710/IB	X		X	
33455000	X	PA-IX 9709/IDC	X	X	X	X
33457000	X	PA-IX 18097/IDC	X	X		
33655000	X	PA-IX 9710/IB	X	X		X

Störning

Orsak

Åtgärd

Blandare är trög	-Patron defekt, förkalkad	-Byt ut patron
Blandare droppar	-Patron defekt, avlagringar	-Byt ut patron
Omkopplare fungerar inte	-För lågt vattentryck -Omkopplare defekt	-Öka vattentrycket -Byt ut omkopplare
För låg varmvattentemperatur, inget kallvatten. Varmvattenberedaren slår på när kallvatten väljs.	-Varmvattenreglering felaktigt inställd -Korsflöde	-Ställ in varmvattenreglering -Byt ut patron

Varmvattenreglering: Varmvattentemperatur 60 C, Kallvattentemperatur 10 C, flödestryck 0,3 MPa.

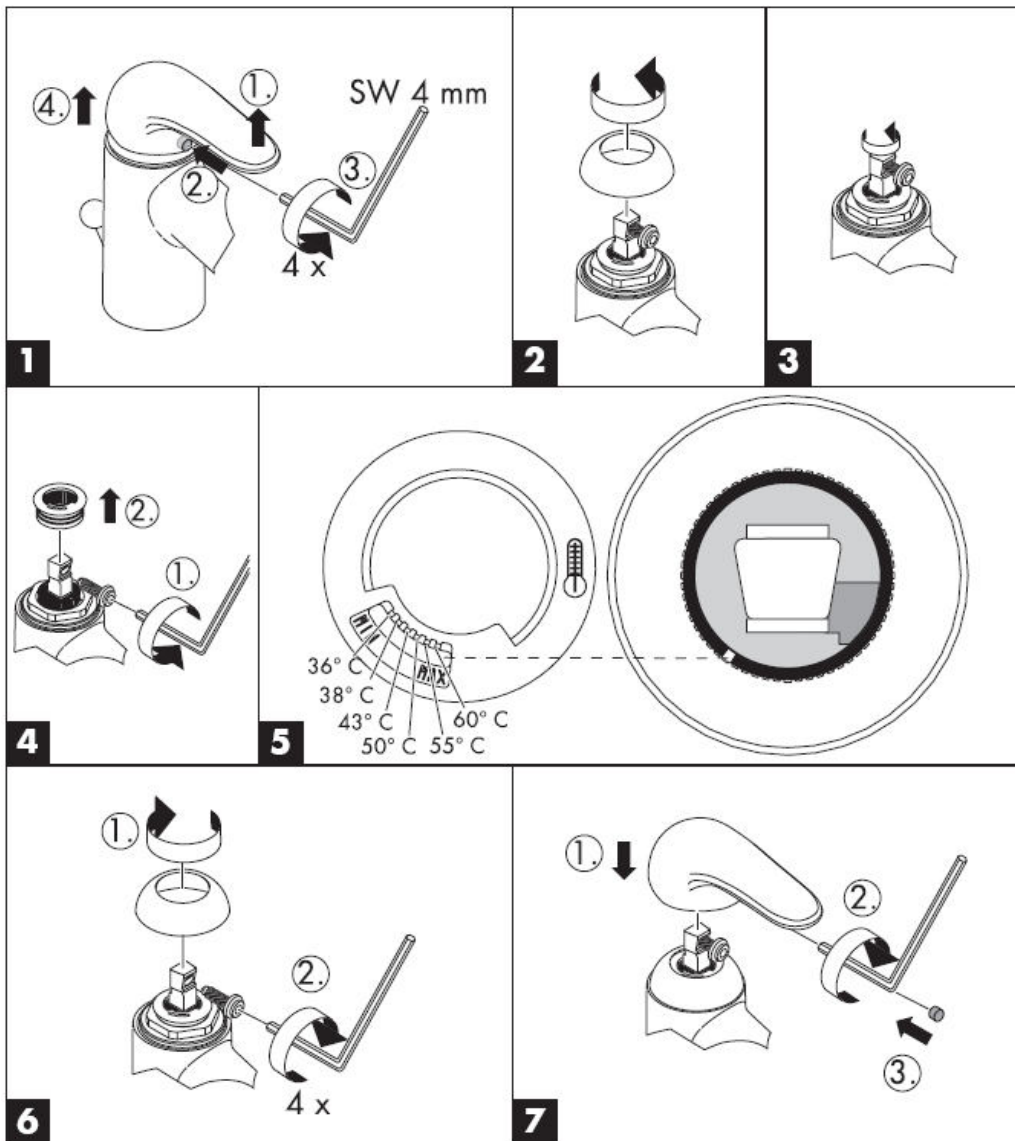

Montavimo instrukcijos



Metropol E
14475XXX/
14477XXX



Metris E
31475000/
31476000



Focus E
31744000



Talis E
33455000/
33457000



Metropol E
14675XXX



Metris E
31675000



Focus E
31761000



Talis E
33655000

hansgrohe

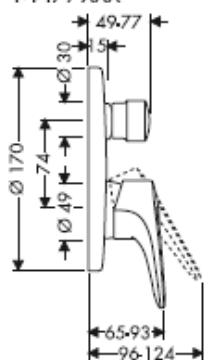
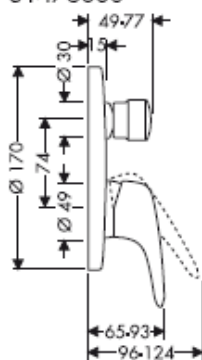
Metropol E14475XXX/
14477XXX**Metris E**31475000/
31476000**Focus E**

31744000

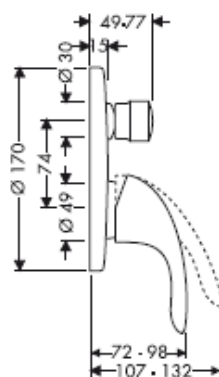
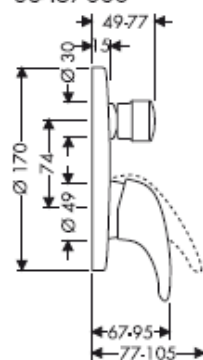
**Talis E**33455000/
33457000**Metropol E**

14675XXX

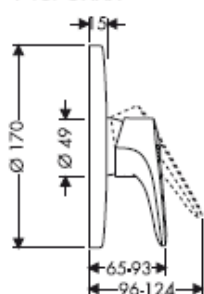
**Metris E**

31675000

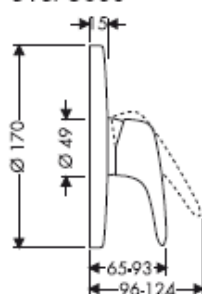
**Focus E**

31761000

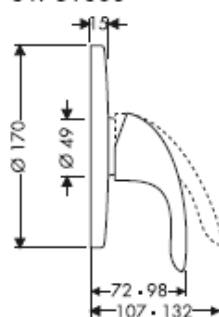
**Talis E**

33655000

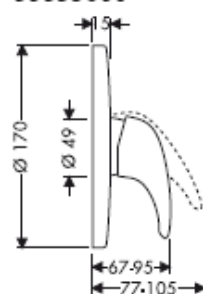

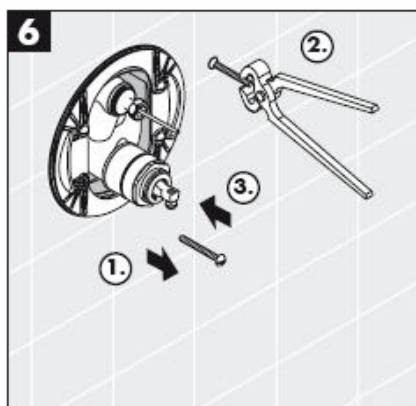
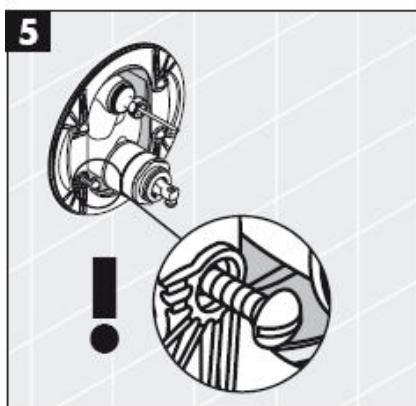
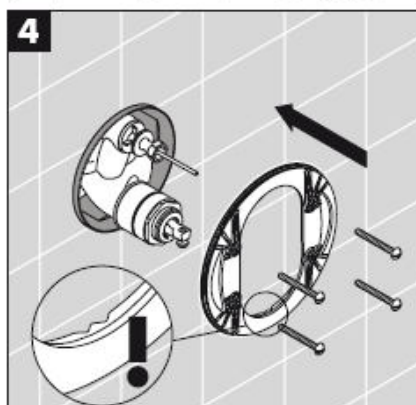
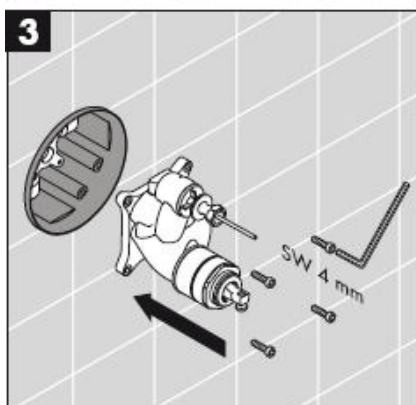
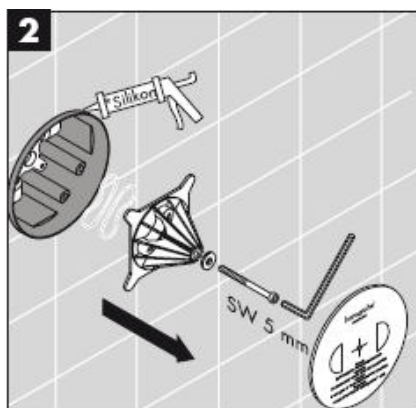
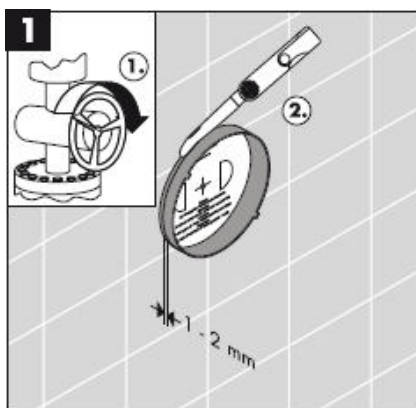

*Silikonas (be acto rūgšties!)

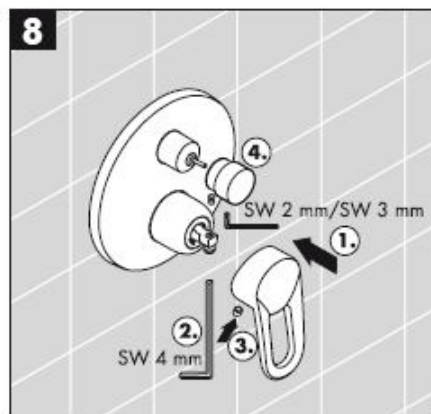
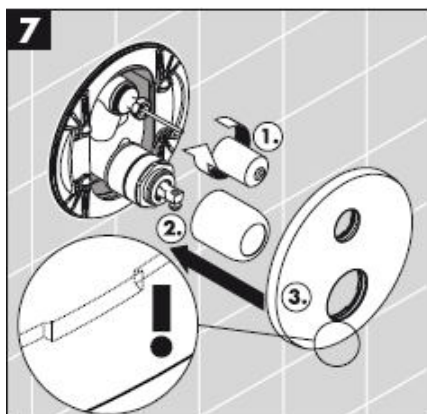

Montavimas

Dėmesio! Maišytuvas privalo būti montuojamas, išleidžiamas ir patikrinamas pagal galiojančias normas!

Eksplotacija

Maišytuvas atidaromas pakėlus rankenėlę. Pasukus į kairę = karštas vanduo, į dešinę = šaltas.

Dušo funkcija įjungžiama patraukus reguliavimo perjungiklį. Uždarius vandenį, funkcija automatiškai grįžta į pradinę padėtį - vonios funkcija.

Techniniai duomenys

Darbinis slėgis: max. 1 MPa
 Rekomenduojamas slėgis: 0,1 – 0,5 MPa
 Bandomasis slėgis: 1,6 MPa
 (1 MPa = 10 barų = 147 PSI)
 Karšto vandens temperatūra: max. 80° C
 Rekomenduojama karšto vandens temperatūra: 65° C

Vandens pralaidumas: 0,3 MPa
 14475XXX / 14477XXX /
 31475000 / 31476000 /
 31744000 / 33455000 / 33457000:

Ištekėjimas vonia ca. 30 l/min
 Ištekėjimas Dušas ca. 24 l/min
 14675XXX / 31675000 /
 31761000 / 33665000: ca. 32 l/min
 Su atbuliniu vožtuvu: 14477XXX
 31476000
 33457000

"Hansgrohe" vienos rankenėlės maišytuvai gali būti naudojami su hidrauliškai ir termiškai reguliuojamais momentiniais šildikliais, kai vandens slėgis mažesnis kaip 0,15 MPa.

Vienos rankenėlės maišytuvas turi karšto vandens ribotuvą (nustatymą žr. psl. 8). Naudojant momentinį šildiklį karšto vandens ribotuvus nebūtinas.

Naudojant su momentiniais šildikliais neįrenginėkite jokių karšto vandens ribotuvų!

"Ibox" visada montuokite virš vonios, kad atsiradus problemai su funkcinėmis dalimis, vanduo galėtų į ją nubėgti!

Kartą per metus turi būti patikrinti šių maišytuvų saugos įtaisai: 14477XXX/31476000/33457000.

Atbulinio vožtuvo apsauga privalo būti tikrinama reguliariai (mažiausiai kartą per metus pagal DIN 1988) pagal DIN EN1717 arba pagal galiojančias nacionalines arba regionines normas.

Atsarginės dalys žr. psl. 3

1	Rankenėlė Metris E	31094XXX
1.1	Dangtis	96338000
2	Rankenėlė Focus E	31791000
3	Rankenėlė Metropol E	14094XXX
4	RankenėlėTalis E	33091000
5	Dangtis	96453XXX
6	Dangtis	96452XXX
7	Dangtis E	95010XXX
8	Vakumo nutraukėjas	96753000
9	fiksavimo varžtai (4)	96454000
10	Dangčio laikiklis	96447000
11	veržlė	95007000
12	fiksavimo varžtas rankenėlei	96059000
13	atbulinis vožtuvas	96655000
14	triukšmo slopintuvus	94073000
15	Perjungiklis	95014000
16	kasetė	92730000
17	mova	96448000
18	Perjungiklio mygtukas	95013XXX
19	(Bandomasis įbėgimas uždarytas - maišytuvas atidarytas (3 pav.) 25 mm	13595000
20	(Bandomasis įbėgimas uždarytas - maišytuvas atidarytas (3 pav.) 22 mm	13596000

XXX = Spalva

000 chrom
 090 chrom/auksas

Bandyto pažyma

	DVGW	P-IX	SVGW	NF	WRAS	KIWA
14475XXX	X	PA-IX 9709/ICC	X		X	
14477XXX		PA-IX 18097/IDC				
14675XXX	X	PA-IX 9710/IB	X		X	
31475000	X	PA-IX 9709/ICC	X		X	
31476000		PA-IX 18097/IDC				
31675000	X	PA-IX 9710/IB	X			
31744000	X	PA-IX 9709/IDC	X			
31761000	X	PA-IX 9710/IB	X		X	
33455000	X	PA-IX 9709/IDC	X	X	X	X
33457000	X	PA-IX 18097/IDC	X	X		
33655000	X	PA-IX 9710/IB	X	X		X

Gedimas**Priežastis****Priemonė**

Sunkiai sukiojama rankenėlė	-Kasetė pažeista, užkalkėjusi	-Pakeisti kasetę
Maišytuvas praleidžia vandenį	-Kasetė pažeista, užkalkėjusi	-Pakeisti kasetę
Perjungėjas nefunkcionuoja	-Nepakankamas vandens spaudimas -Pažeistas perjungėjas	-Pakelti vandens spaudimą -Pakeisti perjungėją
Per maža karšto vandens temperatūra, nėra šalto vandens. Momentinis pašildytojas pradeda veikti, kai naudojamas šalta vanduo	-Neteisingai nustatytas karšto vandens ribotuvus -Kryžminė srovė	-Nustatyti karšto vandens ribotuvą -Pakeisti kasetę

Karšto vandens ribtuvas: karšto vandens temperatūra 60 C, šalto vandens - 10 C, slėgis 0,3 MPa..

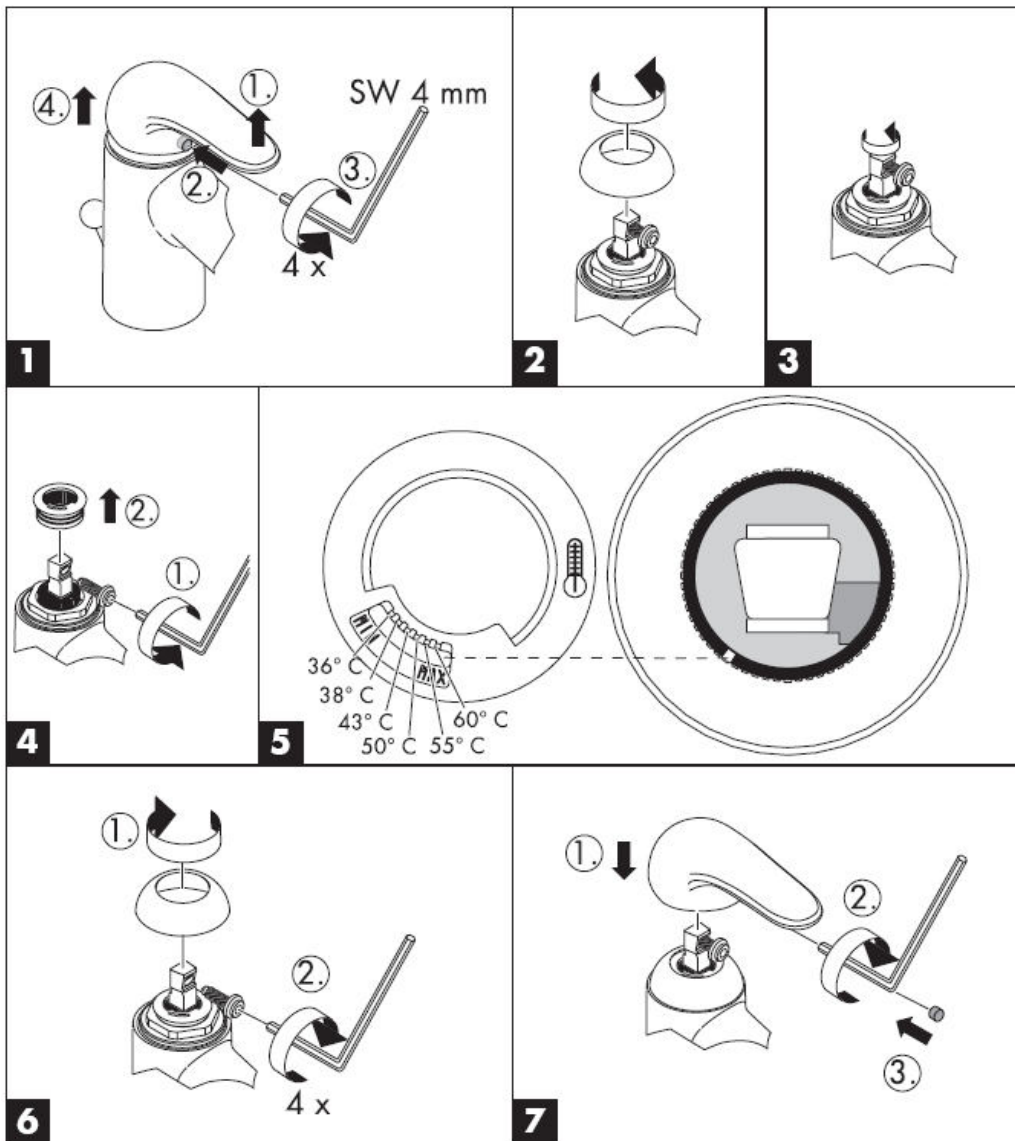

Uputstva za instalaciju



Metropol E
14475XXX/
14477XXX



Metris E
31475000/
31476000



Focus E
31744000



Talis E
33455000/
33457000



Metropol E
14675XXX



Metris E
31675000



Focus E
31761000



Talis E
33655000

hangrohe

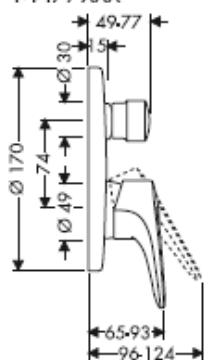
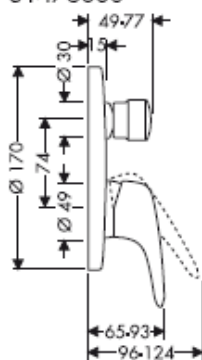
Metropol E14475XXX/
14477XXX**Metris E**31475000/
31476000**Focus E**

31744000

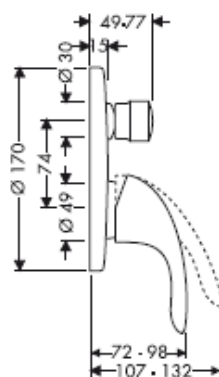
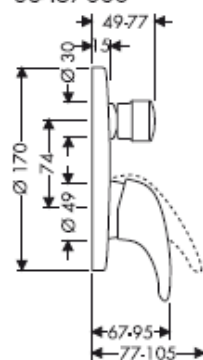
**Talis E**33455000/
33457000**Metropol E**

14675XXX

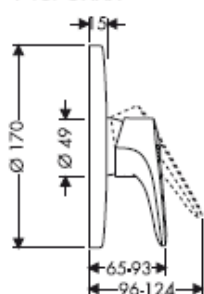
**Metris E**

31675000

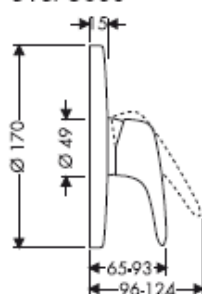
**Focus E**

31761000

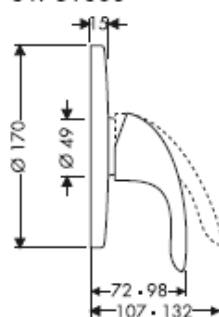
**Talis E**

33655000

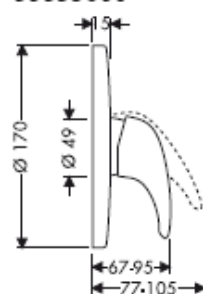

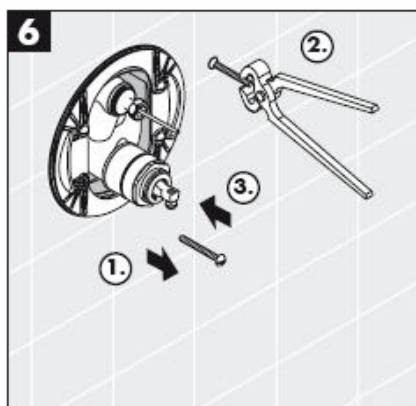
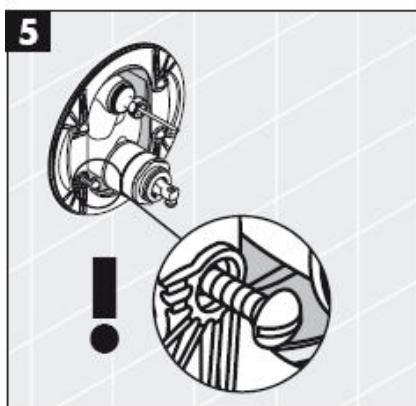
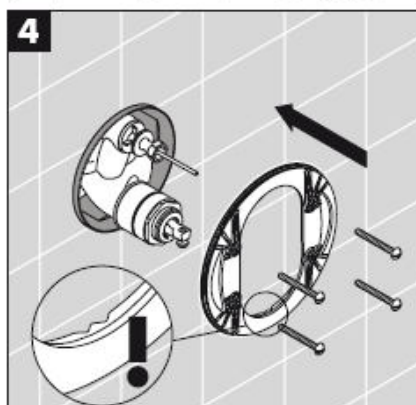
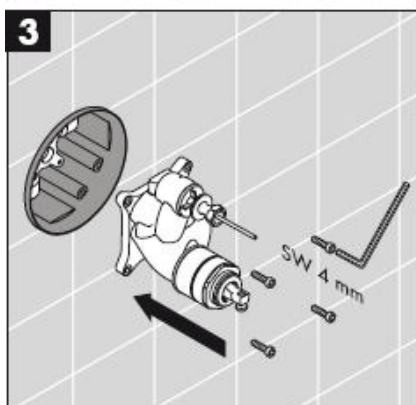
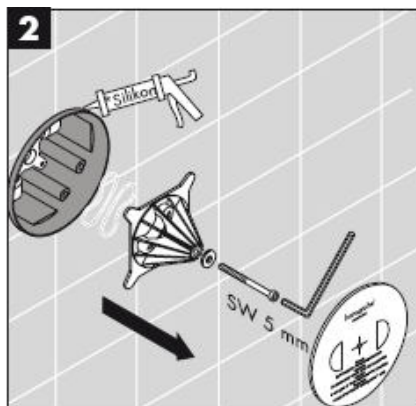
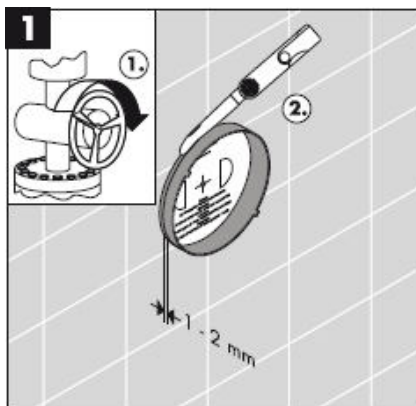

*Silikon (ne sadrži kiseline)

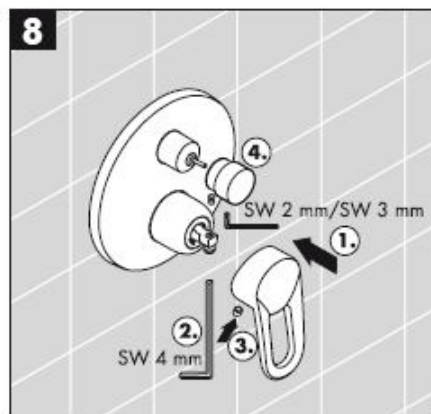
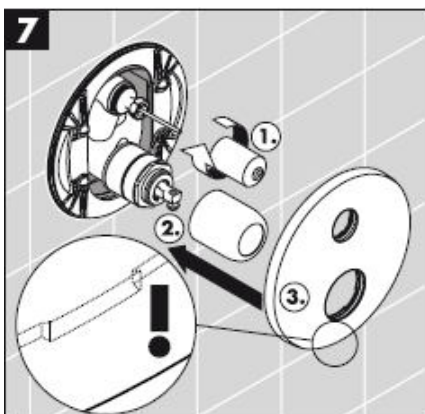

Sastavljanje

Pažnja! Cijevi moraju biti postavljene, isprane i testirane prema važećim normama!

Upotreba

Slavina se otvara podizanjem ručice.
Okretanje ulijevo = topla voda, udesno = hladna voda.
Prebacivanje na ručni tuš povlačenjem ručice selektora. Nakon zatvaranja slavine mješalica se automatski vraća u početnu poziciju.

Tehnički podatci

Najveći dopušteni tlak:	max. 1 MPa
Preporučeni tlak:	0,1 – 0,5 MPa
Probni tlak:	1,6 MPa
(1 MPa = 10 bara = 147 PSI)	
Temperatura vruće vode:	max. 80° C
Preporučena temperatura vruće vode:	65° C
Protok vode: 0,3 MPa	
14475XXX / 14477XXX /	
31475000 / 31476000 /	
31744000 / 33455000 / 33457000:	
izlaz Kada	ca. 30 l/min
izlaz Tuš	ca. 24 l/min
14675XXX / 31675000 /	
31761000 / 33665000:	ca. 32 l/min
Funkcije samo-čišćenja:	14477XXX
	31476000
	33457000

Hansgrohe jednoručne slavine se mogu koristiti sa hidrauličnim i termički kontroliranim protočnim bojlerima ako je tlak najmanje 0,15 MPa.

Da bi podesili limiter vruće vode na jednoručnim slavinama molimo Vas da pogledate stranicu 8. Podešavanje nije potrebno ako koristite protočni bojler.

U kombinaciji sa protočnim bojlerima ne smije se ugraditi sustav za blokiranje dotoka tople vode

Budući da kod kvara pojedinih dijelova iz ibox-a može otjecati voda, ibox je potrebno instalirati iznad kade kako bi voda mogla otjecati u kadu!

Sigurnosna jedinica armature 14477XXX/31476000/33457000 mora se provjeravati jednom godišnje

Ispravnost nepovratnog ventila mora se redovito provjeravati prema standardu DIN EN 1717 i u skladu sa važećim propisima (najmanje jednom godišnje).

Rezervni dijelovi pogledaj stranicu 3

1	Ručica Metris E	31094XXX
1.1	Poklopac vijka	96338000
2	Ručica Focus E	31791000
3	Ručica Metropol E	14094XXX
4	RučicaTalis E	33091000
5	Rozete	96453XXX
6	Rozete	96452XXX
7	Poklopac E	95010XXX
8	Crijevni odzračivač	96753000
9	Vijak nosača (4)	96454000
10	Rozeta nosača	96447000
11	Matica	95007000
12	Sigurnosni vijak	96059000
13	nepovratni ventil	96655000
14	Prigušivač buke	94073000
15	selektor	95014000
16	Uložak	92730000
17	Čahura selektora	96448000
18	Gumb usmjerivača	95013XXX
19	Produljenje 25 mm	13595000
20	Produljenje 22 mm	13596000

XXX = Boje

000 krom
090 krom/zlato

Oznaka testiranja

	DVGW	P-IX	SVGW	NF	WRAS	KIWA
14475XXX	X	PA-IX 9709/ICC	X		X	
14477XXX		PA-IX 18097/IDC				
14675XXX	X	PA-IX 9710/IB	X		X	
31475000	X	PA-IX 9709/ICC	X		X	
31476000		PA-IX 18097/IDC				
31675000	X	PA-IX 9710/IB	X			
31744000	X	PA-IX 9709/IDC	X			
31761000	X	PA-IX 9710/IB	X		X	
33455000	X	PA-IX 9709/IDC	X	X	X	X
33457000	X	PA-IX 18097/IDC	X	X		
33655000	X	PA-IX 9710/IB	X	X		X

Greška

Uzrok

Otklanjanje

Ručica se zaglavila	-Neispravan uložak Taloženje kamenca	-Zamijenite uložak
Slavina kaplje	-Neispravan uložak, naslage kamenca	-Zamijenite uložak
Selektor ne radi	-Prenizak tlak vode -Selektor je neispravan	-Povećajte tlak vode -Zamijenite selektor
Preniska temperatura vruće vode, nedostatak hladne vode. Protočni bojler se pali pri podešenoj funkciji za protok hladne vode	-Limiter vruće vode nije dobro podešen -Križni tok vode	-Podesite limiter vruće vode -Zamijenite uložak

Limitir vruće vode: temperatura vruće vode 60 C, temperatura hladne vode 10 C, tlak 0,3 MPa.

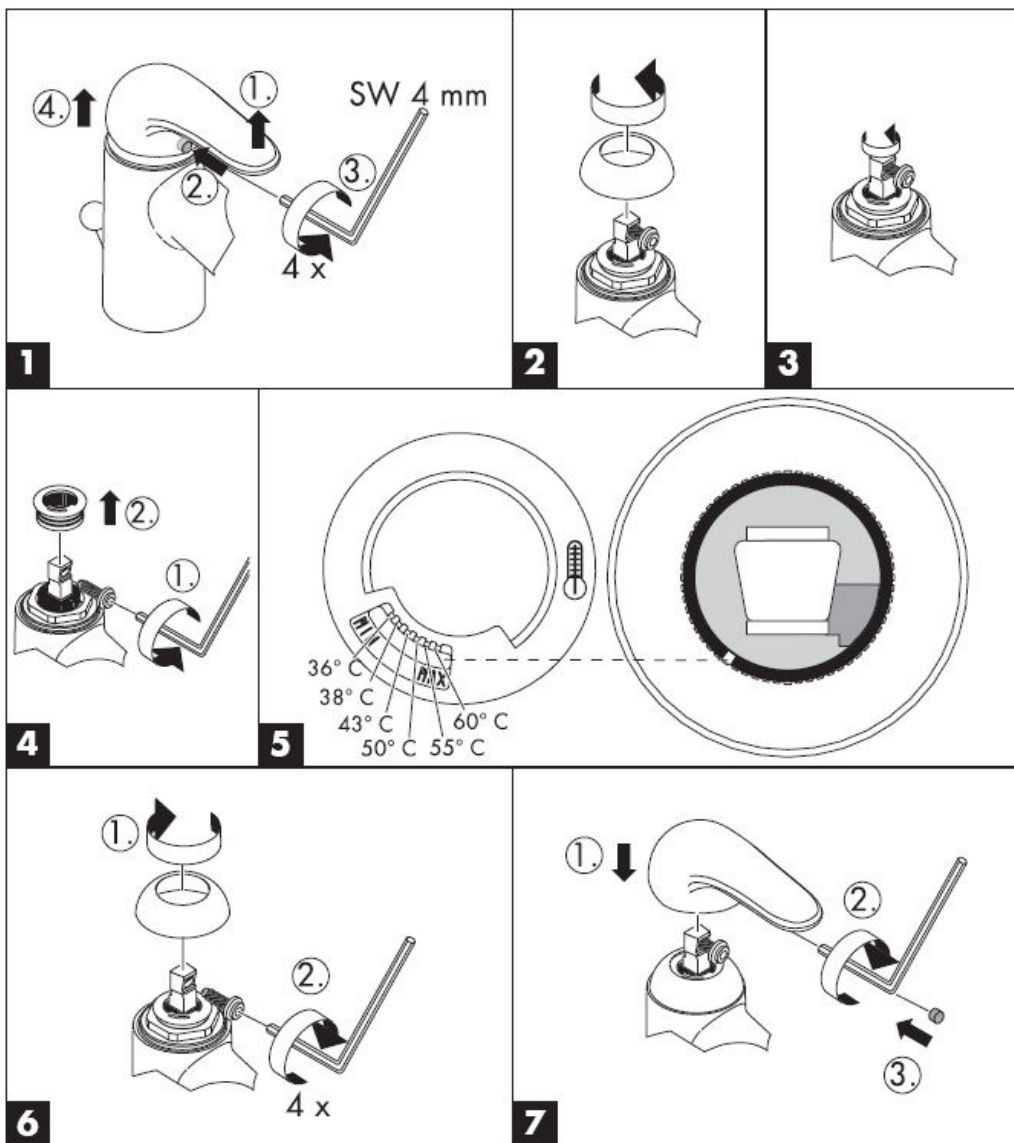

Hansgrohe

Montaj kılavuzu



Metropol E
14475XXX/
14477XXX



Metris E
31475000/
31476000



Focus E
31744000



Talis E
33455000/
33457000



Metropol E
14675XXX



Metris E
31675000



Focus E
31761000



Talis E
33655000

hansgrohe

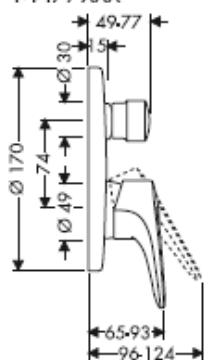
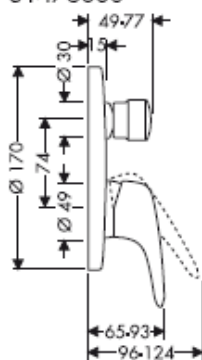
Metropol E14475XXX/
14477XXX**Metris E**31475000/
31476000**Focus E**

31744000

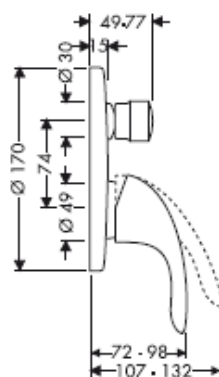
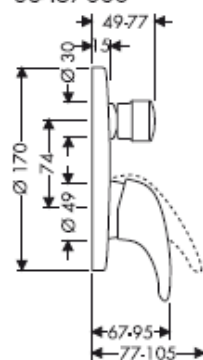
**Talis E**33455000/
33457000**Metropol E**

14675XXX

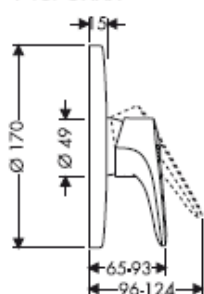
**Metris E**

31675000

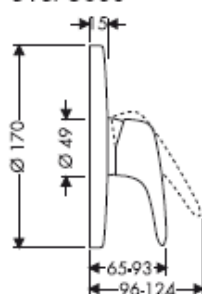
**Focus E**

31761000

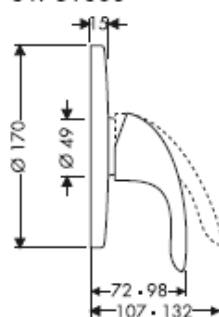
**Talis E**

33655000

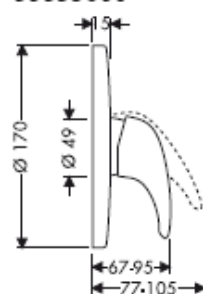

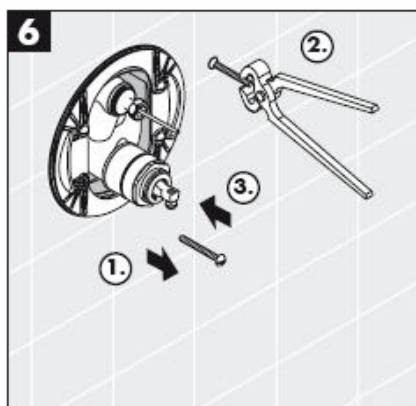
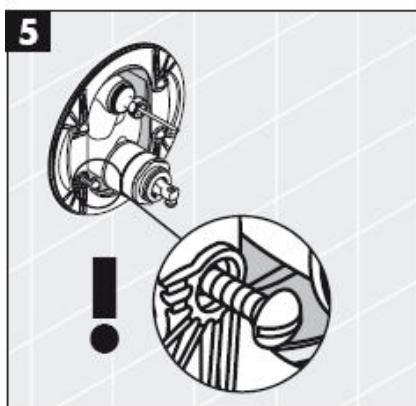
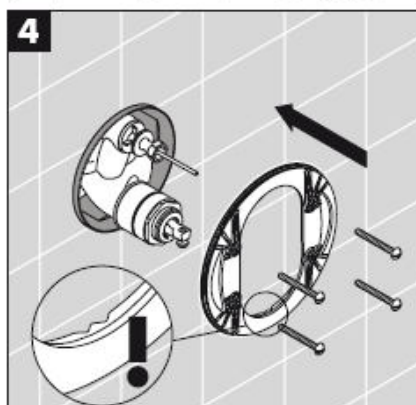
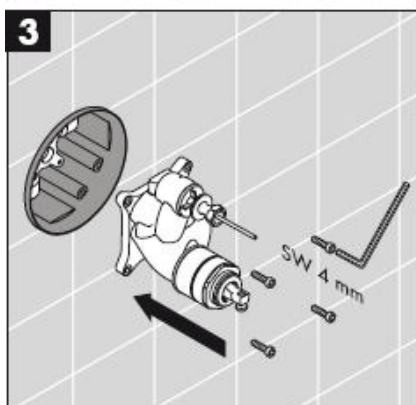
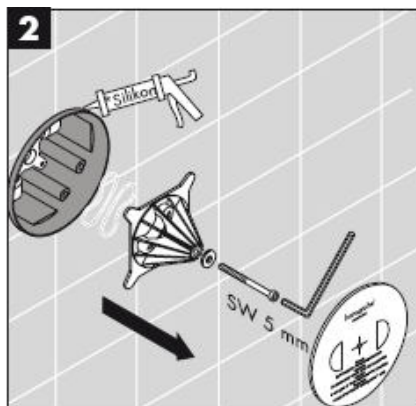
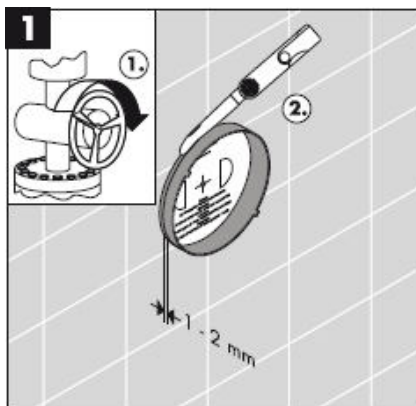

*Silikon (asetik asit içermeyen)

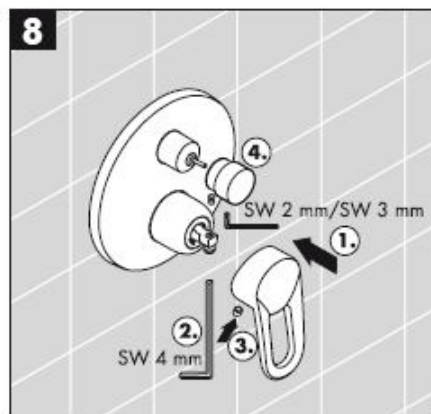
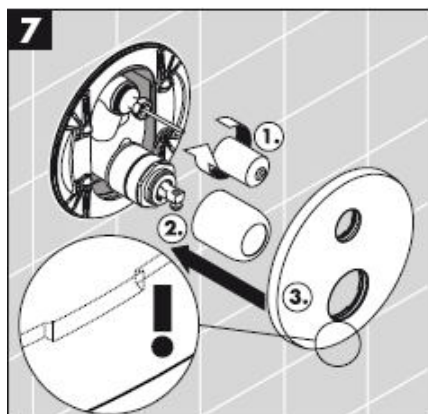

Montajı

Önemli! Batarya geçerli normlara göre monte edilmeli, yıkanmalı ve kontrol edilmelidir!

Kullanımı

Musluk kolunu yukarıya doğru kaldırınca miks batarya açılır.
Sola çevirme = sıcak su, sağa çevirme = soğuk su.
Divertör düğmesinden çekerek el duşunu değiştirin. Geri ayar, kumanda kolu kapatılarak otomatik şekilde gerçekleşir.

Teknik bilgiler

İşletme basıncı:	max. 1 MPa
Tavsiye edilen işletme basıncı:	0,1 – 0,5 MPa
Kontrol basıncı:	1,6 MPa
(1 MPa = 10 bar = 147 PSI)	
Sıcak su sıcaklığı:	max. 80° C
Tavsiye edilen su ısısı:	65° C
Debisi : 0,3 MPa	
14475XXX / 14477XXX /	
31475000 / 31675000 /	
31744000 / 33455000 / 33457000:	
Çıkış Küvet	ca. 30 l/min
Çıkış Su püskürtücü	ca. 24 l/min
14675XXX / 31675000 /	
31761000 / 33665000:	ca. 32 l/min
Geri emme önleyici:	14477XXX
	31476000
	33457000

Su akış basıncı en azından 0,15 MPa olan yerlerde Hansgrohe tek kollu bataryalarını, hidrolik ve termik kumandalı şofbenlerle birlikte kullanabilirsiniz.

Sıcak su sınırlayıcı özelliğine sahip tek kollu bataryanın ayarlanması için 8. sayfaya bakınız. Bir sürekli akışlı su ısıtıcısı ile birlikte kullanılırsa sıcak su sınırlayıcısına gerek kalmaz.

Şofbenlerle bağlantılı olarak bir sıcak su kilidi takılması olmamalıdır!

Fonksiyon parçalarının arızalanması durumunda ibox'tan su çıkabileceği için, dışarı çıkan suyun küvete akabilmesi için ibox küvetin üzerine monte edilmelidir.

14477XXX/31476000/33457000 bataryalarındaki emniyet tertibatlarına yılda bir kez çalışma kontrolü yapılmalıdır.

DIN EN 1717 ve ulusal standartlar doğrultusunda Çek valfler düzenli olarak kontrol edilmelidir. (en az yılda bir kez)

Yedek Parçalar Bakınız sayfa 3

1	Kumanda kolu Metris E	31094XXX
1.1	Vida tıpası	96338000
2	Kumanda kolu Focus E	31791000
3	Kumanda kolu Metropol E	14094XXX
4	Kumanda kolu Talis E	33091000
5	Yedek parça	96453XXX
6	Yedek parça	96452XXX
7	Bilyeli rozet E	95010XXX
8	Boru havalandırıcı	96753000
9	Taşıyıcı vidalar (4)	96454000
10	Taşıyıcı rozet	96447000
11	Somun	95007000
12	Güvenlik vidası	96059000
13	Çek valf	96655000
14	Susturucu	94073000
15	Divertör (komple)	95014000
16	Kartuş	92730000
17	Divertör, komple	96448000
18	Divertör kolu	95013XXX
19	(Test girişi kapalı – Karıştırıcı açık) (Şekil 3)	25 mm 13595000
20	(Test girişi kapalı – Karıştırıcı açık) (Şekil 3)	22 mm 13596000

XXX = Renkler

000	Krom
090	Krom/Altın

Türkçe

Kontrol işareti

	DVGW	P-IX	SVGW	NF	WRAS	KIWA
14475XXX	X	PA-IX 9709/ICC	X		X	
14477XXX		PA-IX 18097/IDC				
14675XXX	X	PA-IX 9710/IB	X		X	
31475000	X	PA-IX 9709/ICC	X		X	
31476000		PA-IX 18097/IDC				
31675000	X	PA-IX 9710/IB	X			
31744000	X	PA-IX 9709/IDC	X			
31761000	X	PA-IX 9710/IB	X		X	
33455000	X	PA-IX 9709/IDC	X	X	X	X
33457000	X	PA-IX 18097/IDC	X	X		
33655000	X	PA-IX 9710/IB	X	X		X

arıza	sebeup	yardımp
Batarya kullanımı ağırlaşıyor	-Kartuş Bozulmuş ve kireçlenmiş olabilir	-Kartuşu deęiřtirin
Batarya su damlatıyor	-Kartuş arızalı, kireçlenmiş	-Kartuşu deęiřtirin
Divertör çalışmıyor	-Su basıncı düşük -Divertör arızalı	-Su basıncını artırın -Divertörü deęiřtirin
Sıcak su sıcaklığı çok düşük, soęuk su yok. Soęuk su seęilince řofben çalışmaya başlıyor.	-Isı limitleyici düzgün çalışmıyor -Çapraz akış	-Isı limitleyiciyi yeniden ayarlayın -Kartuşu deęiřtirin

Sıcak su sınırlaması: Sıcak su sıcaklığı 60 C, soğuk su sıcaklığı 10 C, akma basıncı 0,3 MPa.

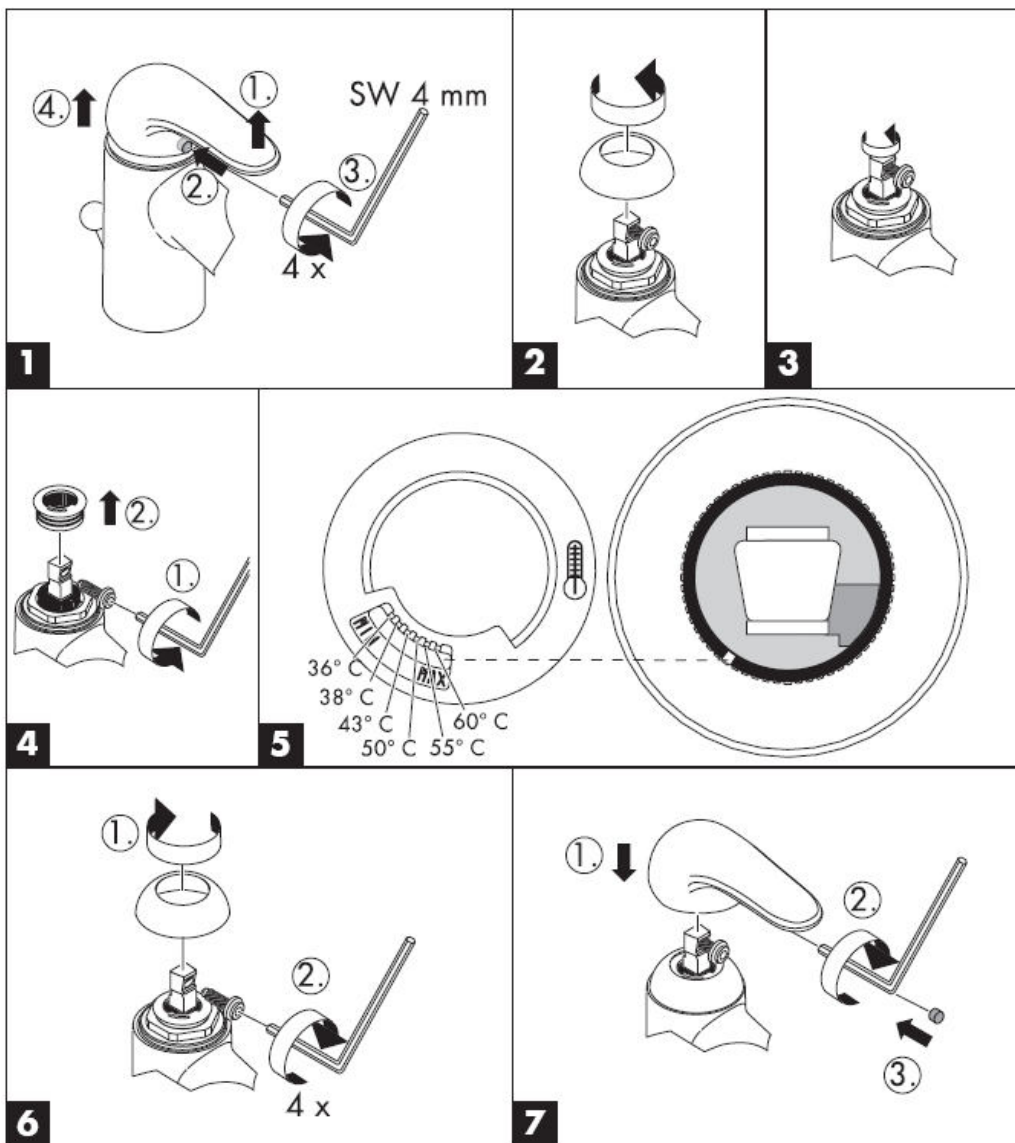

Instrucțiuni de montare



Metropol E
14475XXX/
14477XXX



Metris E
31475000/
31476000



Focus E
31744000



Talis E
33455000/
33457000



Metropol E
14675XXX



Metris E
31675000



Focus E
31761000



Talis E
33655000

hansgrohe

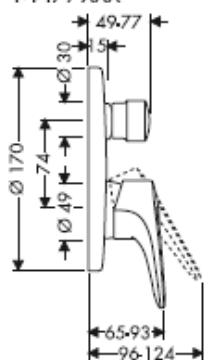
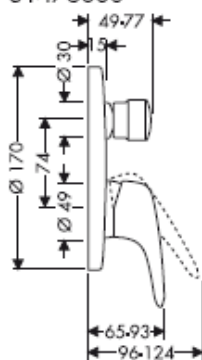
Metropol E14475XXX/
14477XXX**Metris E**31475000/
31476000**Focus E**

31744000

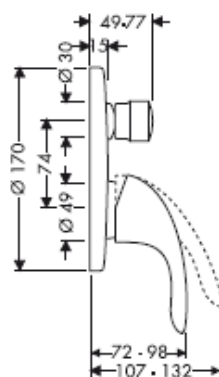
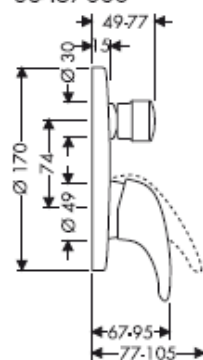
**Talis E**33455000/
33457000**Metropol E**

14675XXX

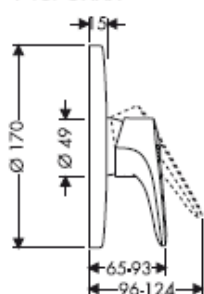
**Metris E**

31675000

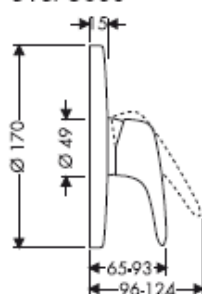
**Focus E**

31761000

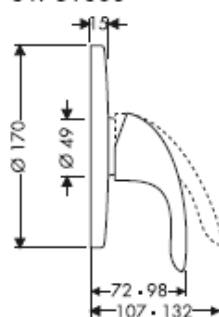
**Talis E**

33655000

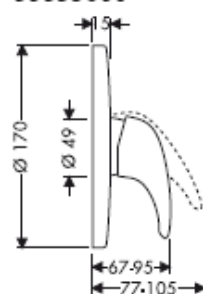

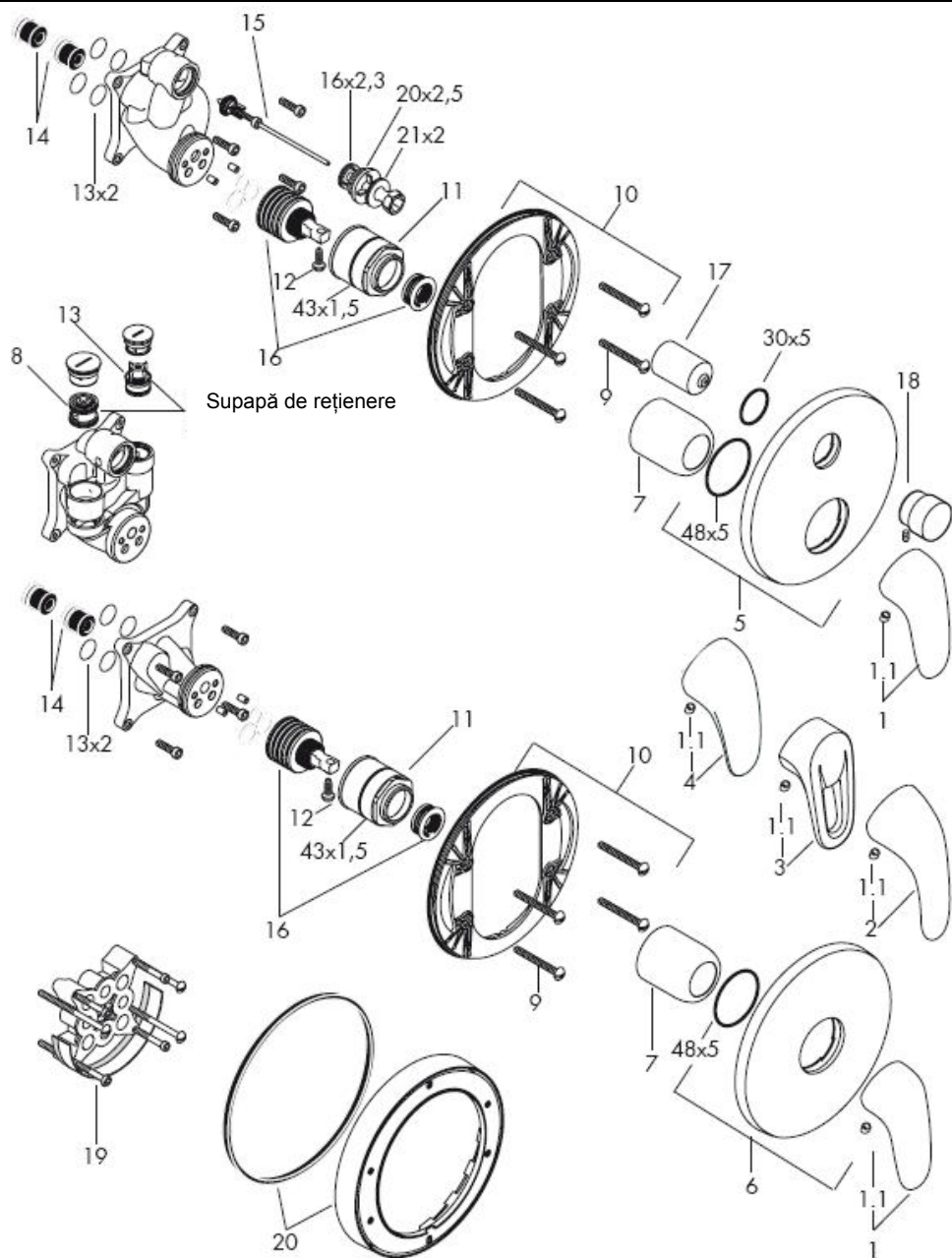

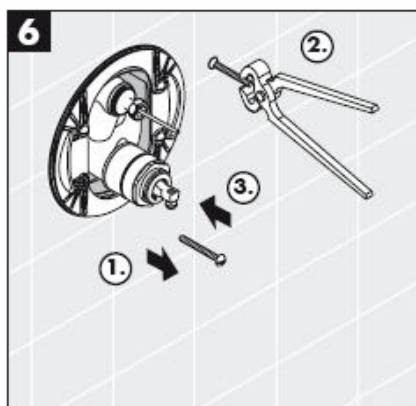
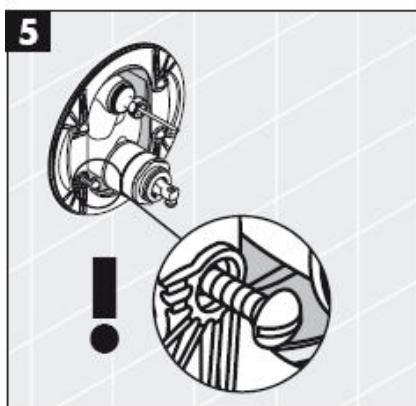
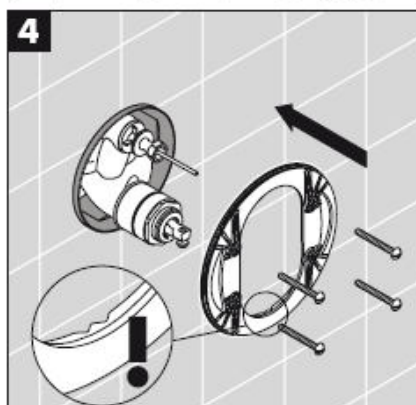
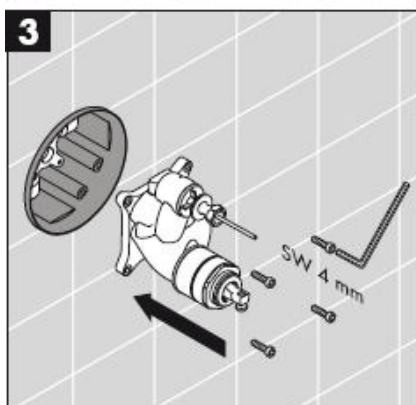
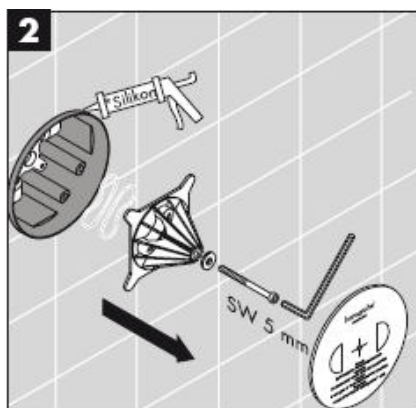
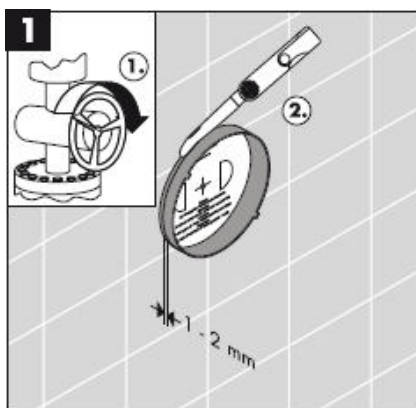

*Silicon (fără acid acetic!)

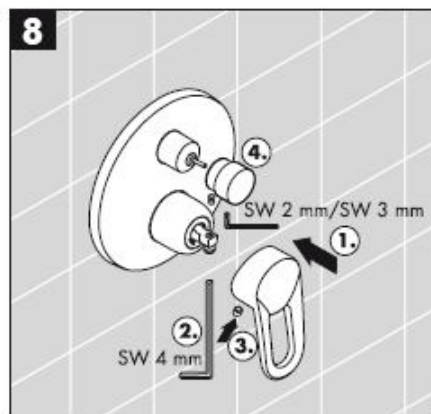
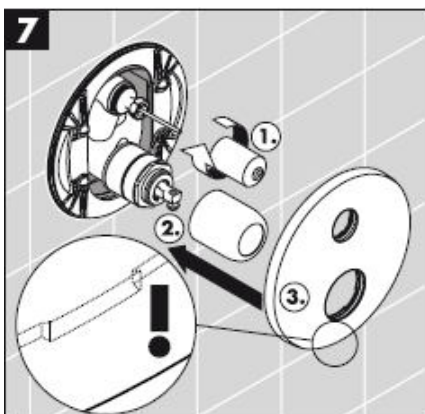

Montare

Atenție! Bateria trebuie montată, clătită și verificată conform normelor în vigoare.

Utilizare

Deschideți bateria prin tragerea manetei.
Rotire spre stânga = apă caldă, spre dreapta = apă rece.
Selectați dușul de mână prin tragerea butonului de comutare. Se revine la jetul normal după închiderea apei la baterie.

Date tehnice

Presiune de funcționare:	max. 1 MPa
Presiune de funcționare recomandată:	0,1 – 0,5 MPa
Presiune de verificare:	1,6 MPa
(1 MPa = 10 bar = 147 PSI)	
Temperatura apei calde:	max. 80° C
Temperatura recomandată a apei calde:	65° C
Debit de apă: 0,3 MPa	
14475XXX / 14477XXX /	
31475000 / 31476000 /	
31744000 / 33455000 / 33457000:	
Evacuare Cadă de baie	ca. 30 l/min
Evacuare Duș	ca. 24 l/min
14675XXX / 31675000 /	
31761000 / 33665000:	ca. 32 l/min
Asigurat contra scurgere înapoi:	14477XXX
	31476000
	33457000

Bateriile monocomadă Hansgrohe pot fi utilizate cu boiler instant cu comandă termică sau hidraulică dacă presiunea apei de alimentare este de min. 0,15 MPa.

Bateria monocomadă cu limitarea apei calde, pentru reglare vezi pag. 8.

Dacă conectați bateria la un boiler instant nu este necesară instalarea unui opritor de apă caldă.

Dacă conectați aparatul la un boiler instant, nu trebuie să utilizați un opritor de apă caldă!

Din cauza posibilității de defectare a componentelor din ibox, montați instalația ibox deasupra căzii pentru ca apa scursă să se evacueze prin cadă.

Instalațiile de siguranță ale bateriei 14477XXX/31476000/33457000 trebuie verificate anual.

Supapele de reținere trebuie verificate regulat conform DIN EN 1717 și standardele naționale sau regionale (anual conform DIN 1988).

Piese de schimb vezi pag. 3

1	Mâner Metris E	31094XXX
1.1	Dop filetat	96338000
2	Mâner Focus E	31791000
3	Mâner Metropol E	14094XXX
4	MânerTalis E	33091000
5	Șild	96453XXX
6	Șild	96452XXX
7	Flanșă E	95010XXX
8	Dezaerator teavă	96753000
9	Șuruburi suport (4)	96454000
10	Șild suport	96447000
11	Piuliță	95007000
12	Șurub de siguranță	96059000
13	Supapă de reținere	96655000
14	Amortizor de zgomot	94073000
15	Comutator cpl.	95014000
16	Cartuș cpl.	92730000
17	Manșon de comutare	96448000
18	Buton de tragere	95013XXX
19	(Orificiul de admisiune este închis - unitatea de amestecare este deschisă) (Fig. 3) 25 mm	13595000
20	(Orificiul de admisiune este închis - unitatea de amestecare este deschisă) (Fig. 3) 22 mm	13596000

XXX = cod de culori

000 crom
090 crom/auriu

Certificat de testare

	DVGW	P-IX	SVGW	NF	WRAS	KIWA
14475XXX	X	PA-IX 9709/ICC	X		X	
14477XXX		PA-IX 18097/IDC				
14675XXX	X	PA-IX 9710/IB	X		X	
31475000	X	PA-IX 9709/ICC	X		X	
31476000		PA-IX 18097/IDC				
31675000	X	PA-IX 9710/IB	X			
31744000	X	PA-IX 9709/IDC	X			
31761000	X	PA-IX 9710/IB	X		X	
33455000	X	PA-IX 9709/IDC	X	X	X	X
33457000	X	PA-IX 18097/IDC	X	X		
33655000	X	PA-IX 9710/IB	X	X		X

Deranjament**Cauza****Măsuri de remediere**

Bateria se mișcă dificil

-Cartuș defect din cauza depunerilor de calcar

-Schimbați cartușul.

Bateria picură

-Cartuș defect din cauza depunerilor

-Schimbați cartușul.

Cartușul nu funcționează.

-Presiune apă prea mică
-Cartuș defect-Măriți presiunea de apă
-Schimbați cartușul.

Temperatura apei este prea mică, nu este apă rece.

-Limitarea temperaturii apei calde setată incorect.

-Setați limitarea temperaturii apei calde.

Boilerul instant pornește când se dă drumul la apa rece

-Curgere încrucișată (apa rece în intră în conducta de apă caldă și invers)

-Schimbați cartușul.

Οδηγία συναρμολόγησης



Metropol E
14475XXX/
14477XXX



Metris E
31475000/
31476000



Focus E
31744000



Talis E
33455000/
33457000



Metropol E
14675XXX



Metris E
31675000



Focus E
31761000



Talis E
33655000

hansgrohe

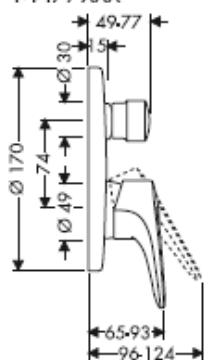
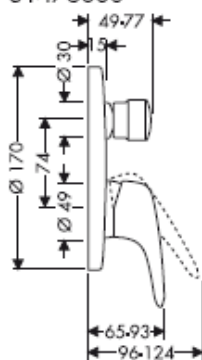
Metropol E14475XXX/
14477XXX**Metris E**31475000/
31476000**Focus E**

31744000

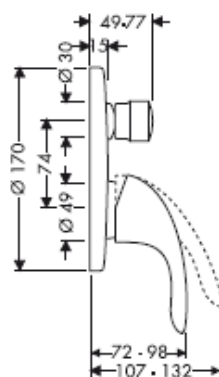
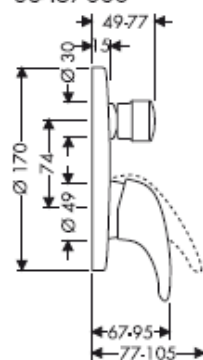
**Talis E**33455000/
33457000**Metropol E**

14675XXX

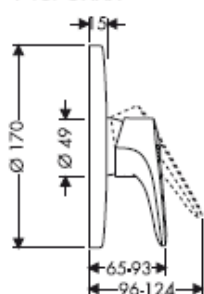
**Metris E**

31675000

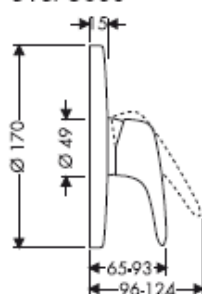
**Focus E**

31761000

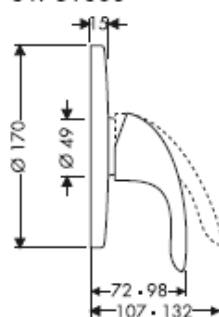
**Talis E**

33655000

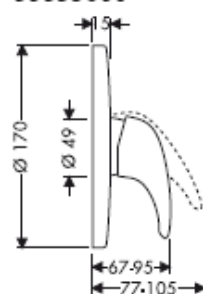

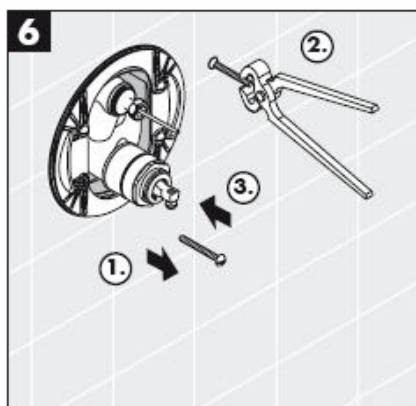
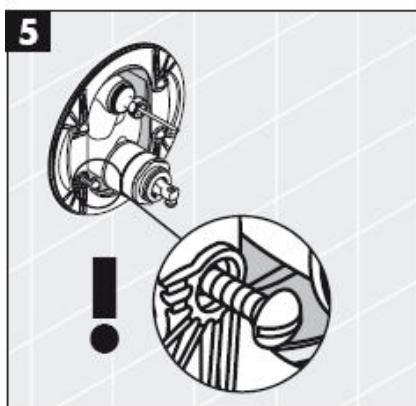
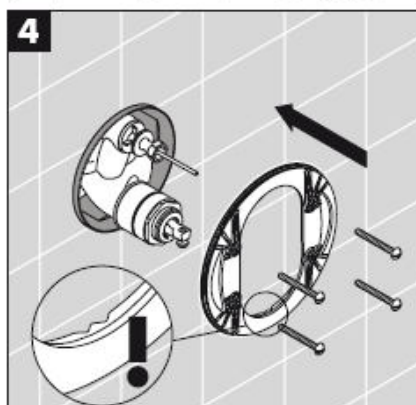
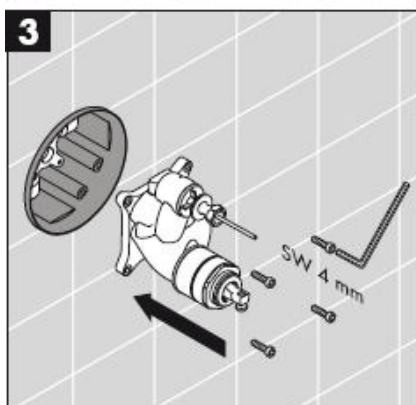
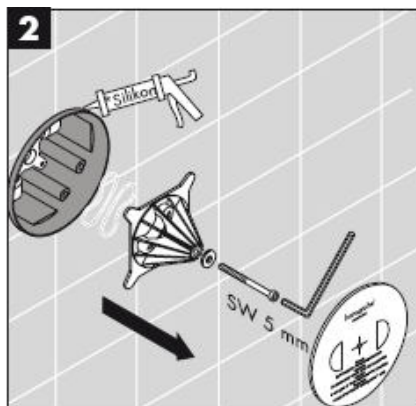
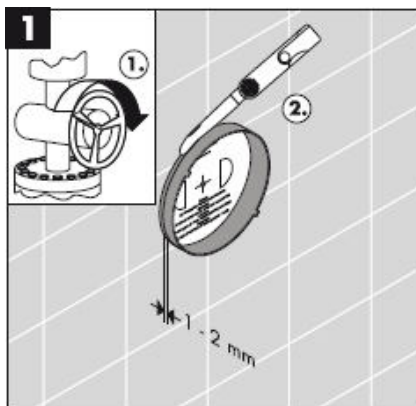

*Σιλικόνη (δίχως οξικό οξύ!)

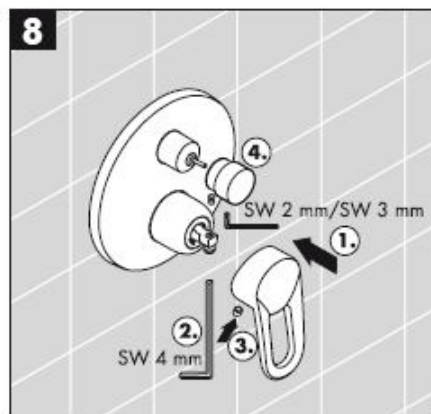
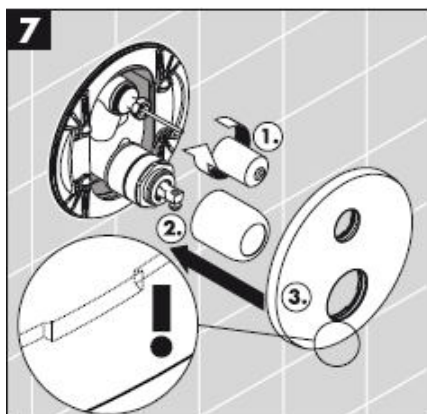

επιτρέπεται η εγκατάσταση διάταξης φραγής νερού!

Συναρμολόγηση

Προσοχή! Η κεντρική βάνα πρέπει να τοποθετηθεί, να πλυθεί και να ελεγχθεί με βάση τους ισχύοντες κανόνες υδραυλικής τέχνης!

Χειρισμός

Η μπαταρία ανοίγει σηκώνοντας την κεντρική λαβή.

Περιστροφή προς τα αριστερά = ζεστό νερό, προς τα δεξιά = κρύο νερό.

Μεταβείτε ε καταιονιστήρα χειρός τραβώντας το κουμπί έλξης. Η επαναφορά της δέσμης πραγματοποιείται αυτόματα με το κλείσιμο της λαβής.

Τεχνικά Χαρακτηριστικά

Λειτουργία πίεσης: max. 1 MPa

Συνιστώμενη λειτουργία πίεσης: 0,1 – 0,5 MPa

Πίεση ελέγχου: 1,6 MPa

(1 MPa = 10 bar = 147 PSI)

Θερμοκρασία ζεστού νερού: max. 80° C

Συνιστώμενη θερμοκρασία ζεστού νερού: 65° C

Κατανάλωση νερού: 0,3 MPa

14475XXX / 14477XXX /

31475000 / 31476000 /

31744000 / 33455000 / 33457000:

Έξοδος Μηχανισμός με μπαταρία μπανιέρας ca. 30 l/min

Έξοδος Ντους ca. 24 l/min

14675XXX / 31675000 /

31761000 / 33665000: ca. 32 l/min

Περιλαμβάνει βαλβίδα αντεπιστροφής.:

14477XXX

31476000

33457000

Οι αναμεικτικές μπαταρίες Hansgrohe μπορούν να λειτουργούν και σε συνδυασμό με ταχυθερμοσίφωνες θερμικού ή υδραυλικού ελέγχου, εφόσον η ελάχιστη πίεση ροής είναι 0,15 MPa.

Για να προσαρμόσετε το δοσομετρητή ζεστού νερού σε αναμεικτικές μπαταρίες, παρακαλούμε δείτε τη ρύθμιση στη σελ. 8.

Δεν είναι απαραίτητη η διάταξη φραγής ζεστού νερού σε συνδυασμό με ταχυθερμοσίφωνα.

	2	Λαβή Focus F	31791000
	3	Λαβή Metropol E	14094XXX
	4	Λαβή Talis E	33091000
	5	Ροζέττα	96453XXX
	6	Ροζέττα	96452XXX
	7	Σφαιρική ροζέττα E	95010XXX
	8	Αερισμός σωλήνων	96753000
	9	Βίδες φορέα (4)	96454000
	10	Ροζέττα φορέα	96447000
	11	Παξιμάδι	95007000
	12	Βίδα ασφάλισης	96059000
	13	Βαλβίδα αντεπιστροφής	96655000
	14	Σιγητήρας	94073000
	15	Επιλογέας, πλήρης	95014000
	16	Φυσίγγιο, πλήρες	92730000
	17	Κέλυφος επιλογέα	96448000
	18	Κουμπί εναλλακτη	95013XXX
	19	Σωλήνας επιμήκυνσης 25 mm	13595000
	20	Σωλήνας επιμήκυνσης 22 mm	13596000

Σε περίπτωση βλάβης των λειτουργικών τμημάτων, μπορεί να εξέρχεται νερό από το ibox, και θα πρέπει η μονάδα ibox να συναρμολογηθεί πάνω από την μπανιέρα, προκειμένου το εξερχόμενο νερό να ρέει μέσα στην μπανιέρα στην περίπτωση αυτή.

Οι διατάξεις ασφαλείας των βανών 14477XXX/31476000/33457000 πρέπει να ελέγχονται μία φορά το χρόνο ως προς τη λειτουργία τους.

Οι βαλβίδες αντεπιστροφής πρέπει να ελέγχονται τακτικά ως προς τη λειτουργία τους, σύμφωνα με τις οδηγίες DIN EN 1717, σε σχέση με τους ισχύοντες εθνικούς ή τοπικούς κανόνες (το ελάχιστο μια φορά το χρόνο, σύμφωνα με το πρότυπο DIN 1988)

Ανταλλακτικά βλ. Σελίδα 3

1	Λαβή Metris E	31094XXX
1.1	πώμα λαβής	96338000

XXX = Χρώματα

000	Επιχρωμιωμένο
090	Επιχρωμιωμένο/ Επιχρυσωμένο

Ελληνικά

Σήμα ελέγχου

	DVGW	P-IX	SVGW	NF	WRAS	KIWA
14475XXX	X	PA-IX 9709/ICC	X		X	
14477XXX		PA-IX 18097/IDC				
14675XXX	X	PA-IX 9710/IB	X		X	
31475000	X	PA-IX 9709/ICC	X		X	
31476000		PA-IX 18097/IDC				
31675000	X	PA-IX 9710/IB	X			
31744000	X	PA-IX 9709/IDC	X			
31761000	X	PA-IX 9710/IB	X		X	
33455000	X	PA-IX 9709/IDC	X	X	X	X
33457000	X	PA-IX 18097/IDC	X	X		
33655000	X	PA-IX 9710/IB	X	X		X

Βλάβη	Αιτία	Διόρθωση
Σκληρή μπαταρία (μείκτης)	-Ελαττωματικό φυσιγγίο, άλατα	-Αλλαγή φυσιγγίου
Η μπαταρία στάζει	-Ελαττωματικό φυσιγγίο, καθιζήσεις	-Αλλαγή φυσιγγίου
Ο διακόπτης επιλογής δεν λειτουργεί	-Ανεπαρκής πίεση νερού	-Αυξήστε την πίεση του νερού
	-Βλάβη στο διακόπτη επιλογής	-Αλλάξτε το διακόπτη επιλογής
Χαμηλή θερμοκρασία ζεστού νερού, καθόλου κρύο νερό. Ο ταχυθερμοσίφωνας ενεργοποιείται, όταν επιλέγεται το κρύο νερό.	-tope de agua caliente mal	-Ρυθμίστε την περιοριστική διάταξη του ζεστού νερού
	-Σταυροειδής ροή	-Αλλαγή φυσιγγίου

Διάταξη περιορισμού ζεστού νερού: θερμοκρασία ζεστού νερού 60 °C, θερμοκρασία κρύου νερού 10 °C, πίεση ροής 0,3 MPa.

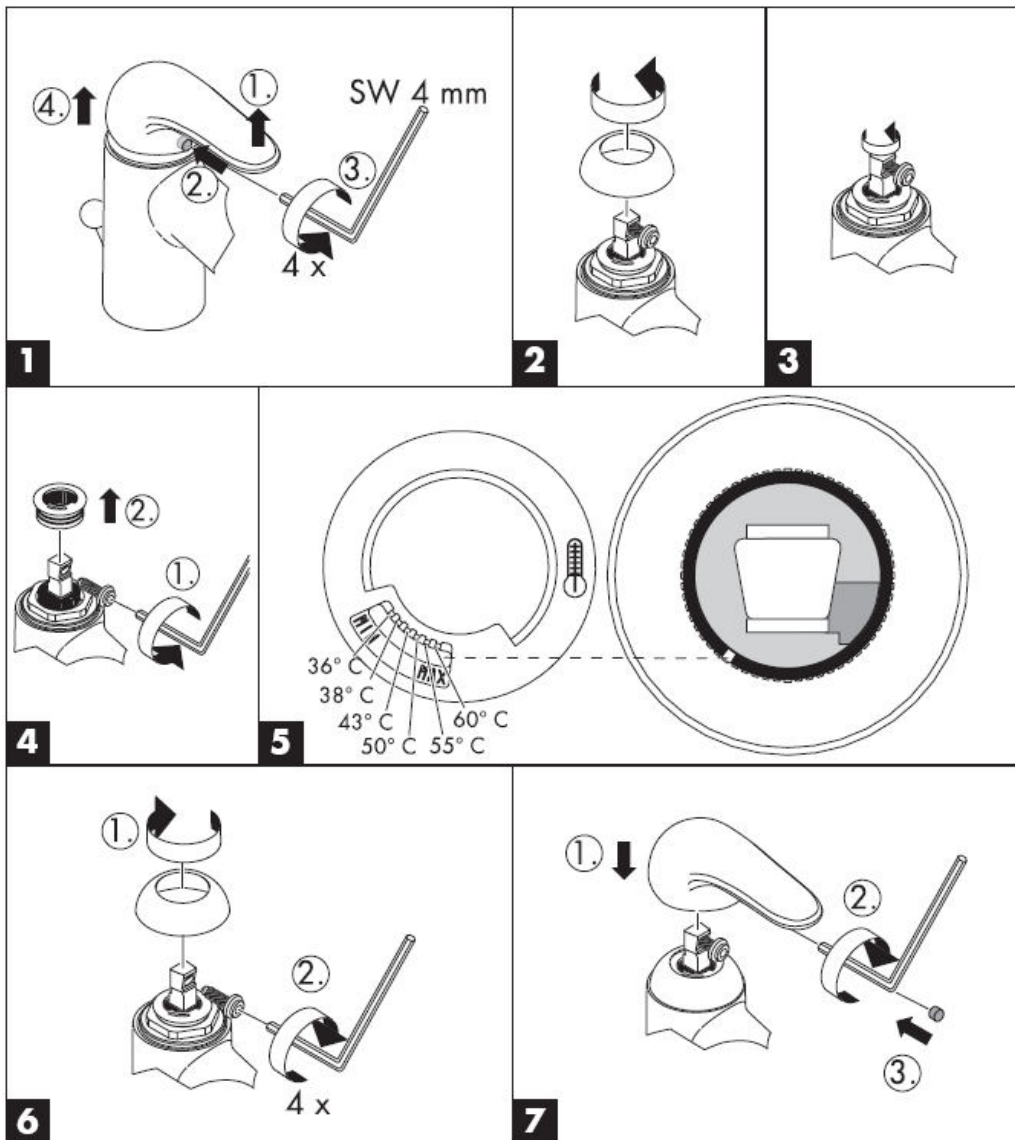

تعليمات التجميع



Metropol E
14475XXX/
14477XXX



Metris E
31475000/
31476000



Focus E
31744000



Talis E
33455000/
33457000



Metropol E
14675XXX



Metris E
31675000



Focus E
31761000



Talis E
33655000

hansgrohe

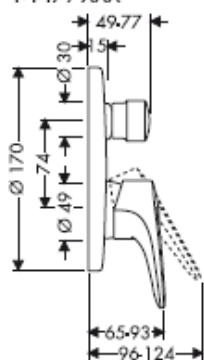
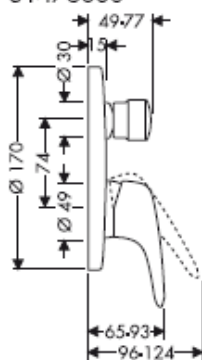
Metropol E14475XXX/
14477XXX**Metris E**31475000/
31476000**Focus E**

31744000

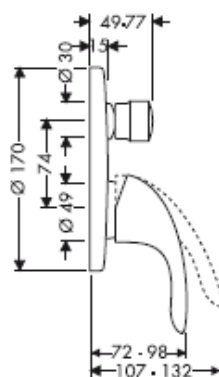
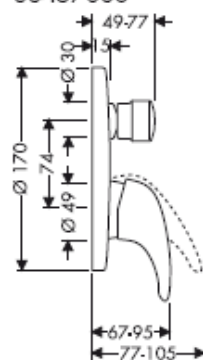
**Talis E**33455000/
33457000**Metropol E**

14675XXX

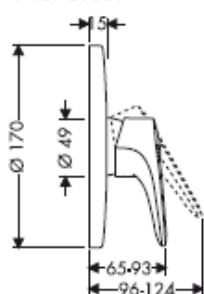
**Metris E**

31675000

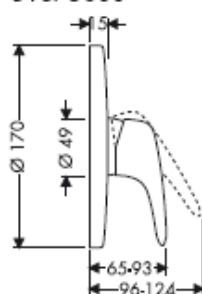
**Focus E**

31761000

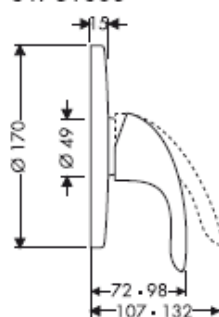
**Talis E**

33655000

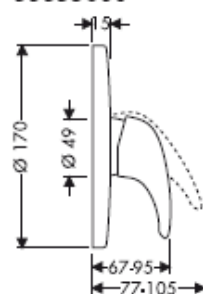

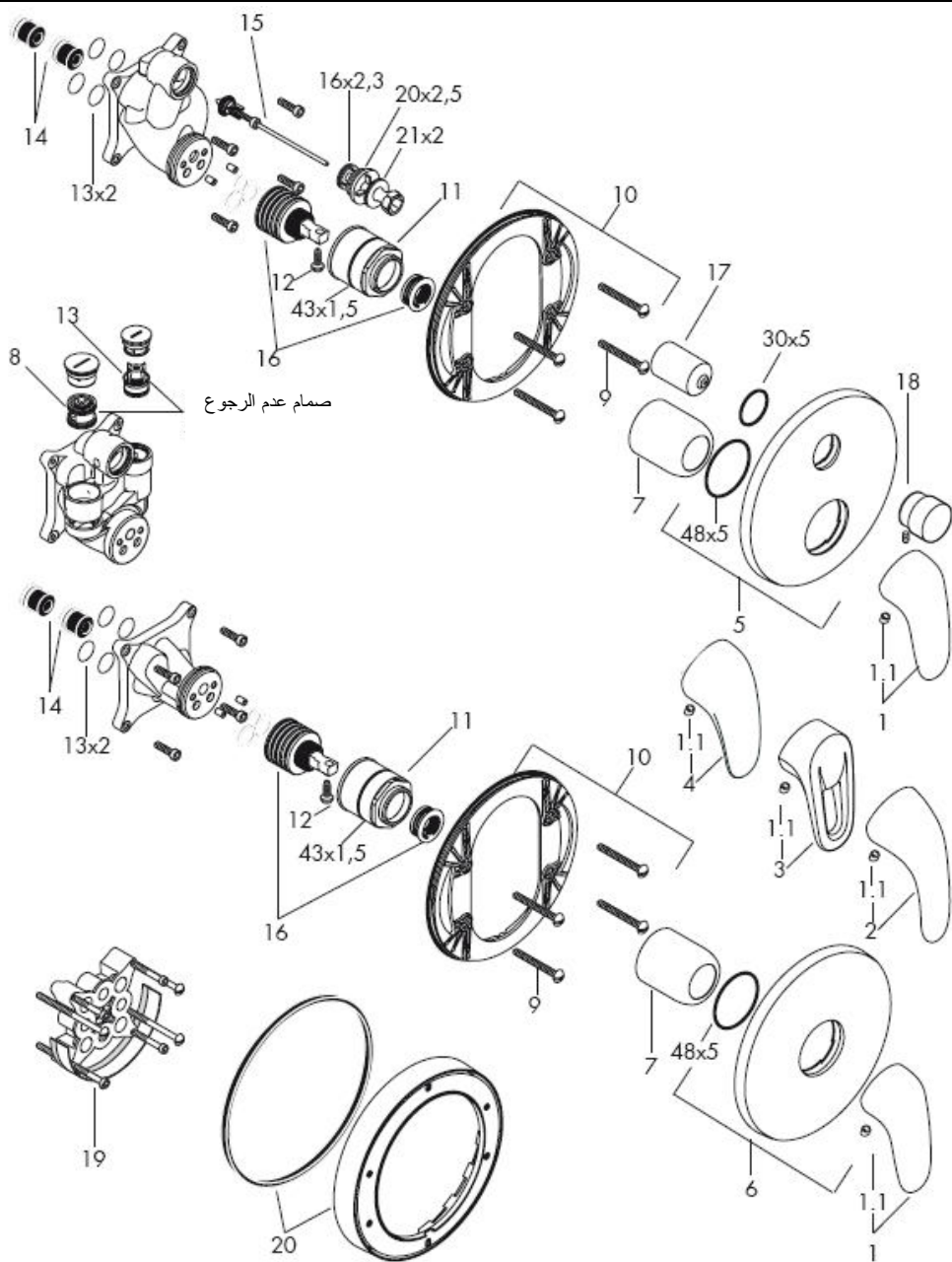

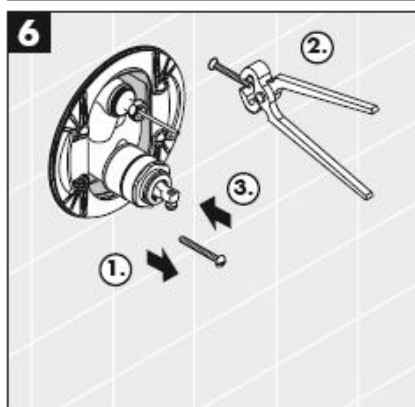
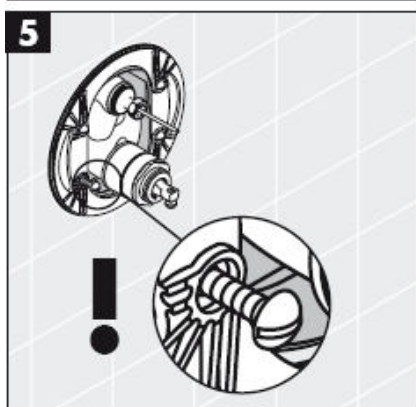
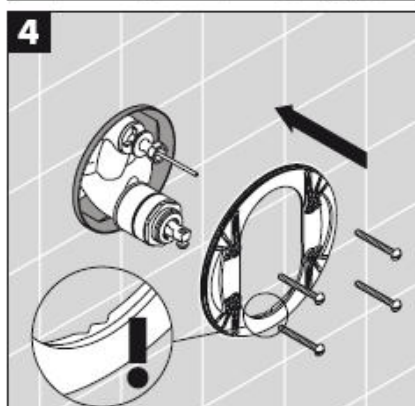
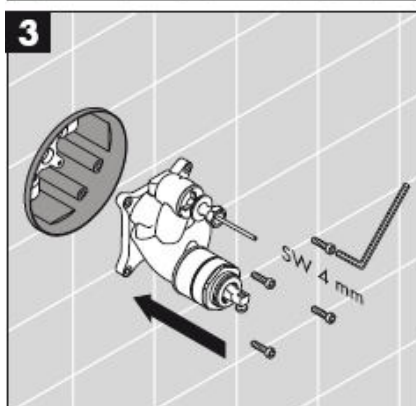
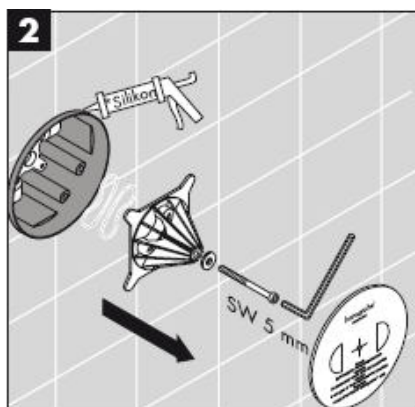
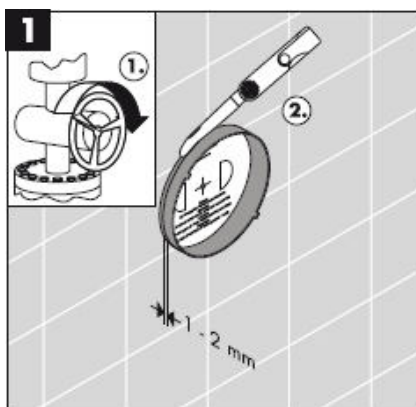

* سيليكون (خالي من حمض الخليك!)

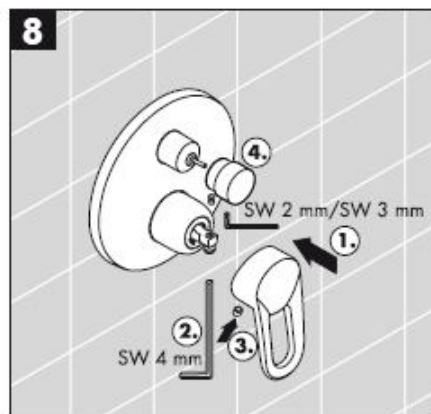
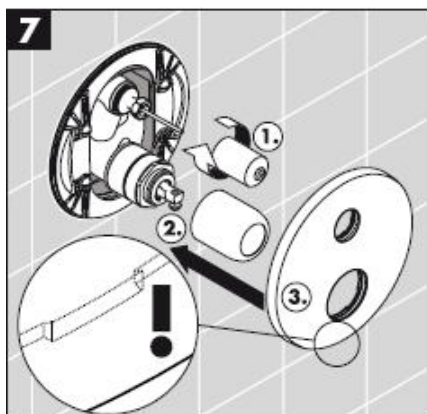

التركيب

احرص دوماً على تركيب ibox فوق حوض الاستحمام (البانيو). إذا تعرضت أجزاء من ibox للكسر، فربما يتسبب ذلك في تسرب المياه في كل مكان!

تتبيه! يجب تركيب الوصلة، وغمرها بالماء واختبارها وفقاً للمعايير السارية!

التشغيل

يجب فحص جهاز الأمان الخاص بكل من
14477 33457000/31476000/XXX مرة واحدة سنوياً.

يجب فحص صمام عدم الرجوع بصفة منتظمة حسب المواصفة DIN EN 1717 وذلك طبقاً للوائح الوطنية أو الإقليمية (مرة واحد سنوياً طبقاً للمواصفة (DIN 1988)

يتم تنشيط الخلاط من خلال سحب مقبض الرافعة.
لف في اتجاه اليسار للحصول على الماء الساخن ولف في اتجاه اليمين للحصول على الماء البارد.
يتحول تدفق المياه من الحوض إلى الدش من خلال سحب مقبض التحويل الموجود أعلى الصنبور. بعد إغلاق تدفق المياه، يعود الخلاط تلقائياً إلى وظيفة الحوض.

قطع الغيار راجع صفحة 3

31094XXX	مقبض Metris E	1
96338000	غطاء ملولب	1.1
31791000	مقبض Focus E	2
14094XXX	مقبض Metropol E	3
33091000	مقبض Talis E	4
96453XXX	طرف	5
96452XXX	طرف	6
95010XXX	لوحة زينة كروية E	7
96753000	تجهيزة تهوية الأنابيب	8
96454000	مسمار التثبيت (4)	9
96447000	لوحة الحامل	10
95007000	صمولة	11
96059000	تأمين مسمار اليد	12
96655000	صمام عدم الرجوع	13
94073000	تقليل الضوضاء	14
95014000	مفتاح الاختيار	15
92730000	خرطوشة	16
96448000	جلبية	17
95013XXX	مقبض المحول	18
13595000	وصلة إبطالة 25 mm	19
13596000	وصلة إبطالة 22 mm	20

XXX\الألوان =

000كروم
090كروم/ذهبي

max. 1 MPa	ضغط التشغيل:
0,1 – 0,5 MPa	ضغط التشغيل الموصى به:
1,6 MPa	ضغط الاختيار:
(1 MPa = 147 PSI بار 10)	
max. 80° C	درجة حرارة الماء الساخن:
65° C	درجة الحرارة الموصى بها للماء الساخن:
	معدل التدفق: 0,3 MPa
	14475XXX / 14477XXX /
	31475000 / 31476000 /
	31744000 / 33455000 / 33457000:
ca. 30 l/min	مخرج بانيو الحمام
ca. 24 l/min	مخرج رشاش
	14675XXX / 31675000 /
ca. 32 l/min	31761000 / 33665000:
14477XXX	التأمين ضد التدفق العكسي:
31476000	
33457000	

يمكن استخدام خلاطات هانزجرهه أحادية المقبض مع سخانات تدفق الماء ذات التحكم الهيدروليكي أو الحراري، مع ضغط تدفق لا يقل عن 1.5 بار.

لضبط محدد الماء الساخن في الخلاطات ذات الرافعة الأحادية، يرجى الرجوع إلى صفحة 8.
ولا يلزم إجراء أي ضبط عند استخدام سخان مياه ذي تدفق مستمر.

لا تقم بتركيب حاجز الماء الساخن مع سخان التدفق!

	DVGW	P-IX	SVGW	NF	WRAS	KIWA
14475XXX	X	PA-IX 9709/ICC	X		X	
14477XXX		PA-IX 18097/IDC				
14675XXX	X	PA-IX 9710/IB	X		X	
31475000	X	PA-IX 9709/ICC	X		X	
31476000		PA-IX 18097/IDC				
31675000	X	PA-IX 9710/IB	X			
31744000	X	PA-IX 9709/IDC	X			
31761000	X	PA-IX 9710/IB	X		X	
33455000	X	PA-IX 9709/IDC	X	X	X	X
33457000	X	PA-IX 18097/IDC	X	X		
33655000	X	PA-IX 9710/IB	X	X		X

العطل	السبب	العلاج والإصلاح
الخلاط ثقيل الحركة	-الخرطوشة تالفة، تراكم عليها الجير	قم بتغيير الخرطوشة
تساقط قطرات مياه من الخلاط المحول لا يعمل	-الخرطوشة تالفة، متراكم عليها الترسبات -ضغط الماء منخفض للغاية -المحول تالف	قم بتغيير الخرطوشة -ارفع ضغط الماء قم بتغيير المحول
درجة حرارة الماء الساخن منخفضة للغاية، ولا يوجد ماء بارد. سخان المياه الفوري يعمل عند استخدام الماء البارد.	-حد الماء الساخن مضبوط بشكل خاطيء -اندفاع متعاكس للمياه	-اضبط حد الماء الساخن قم بتغيير الخرطوشة

محدد الماء الساخن: درجة حرارة الماء الساخن 60 مئوية، درجة حرارة الماء البارد تبلغ 10 مئوية، ضغط التدفق 3 بار.

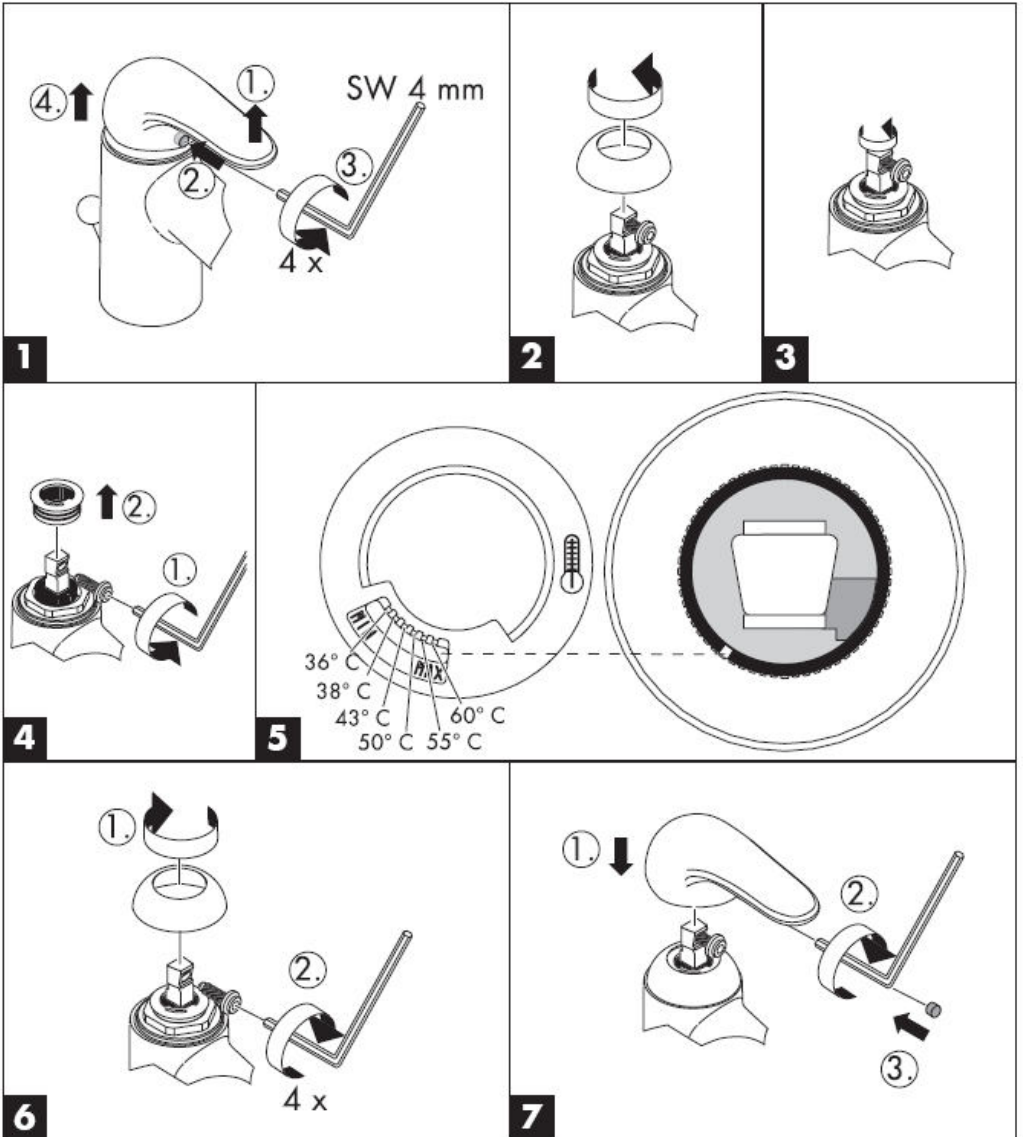

Navodila za montažo



Metropol E
14475XXX/
14477XXX



Metris E
31475000/
31476000



Focus E
31744000



Talis E
33455000/
33457000



Metropol E
14675XXX



Metris E
31675000



Focus E
31761000



Talis E
33655000

hansgrohe

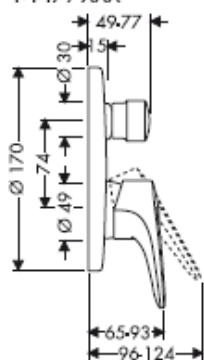
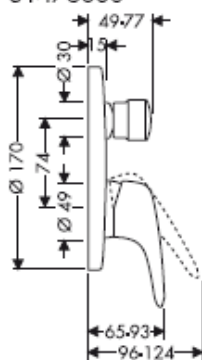
Metropol E14475XXX/
14477XXX**Metris E**31475000/
31476000**Focus E**

31744000

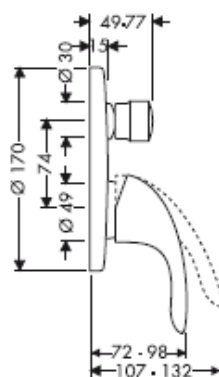
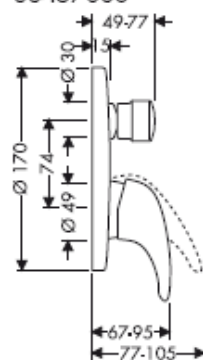
**Talis E**33455000/
33457000**Metropol E**

14675XXX

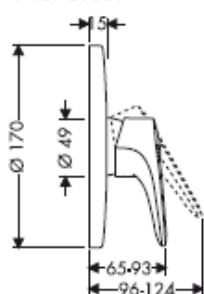
**Metris E**

31675000

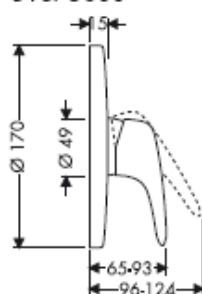
**Focus E**

31761000

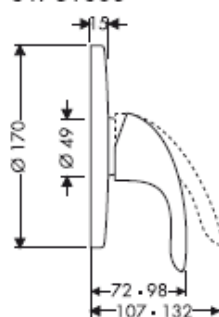
**Talis E**

33655000

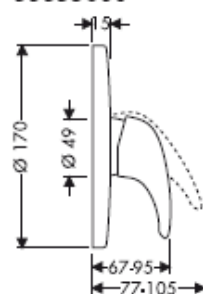

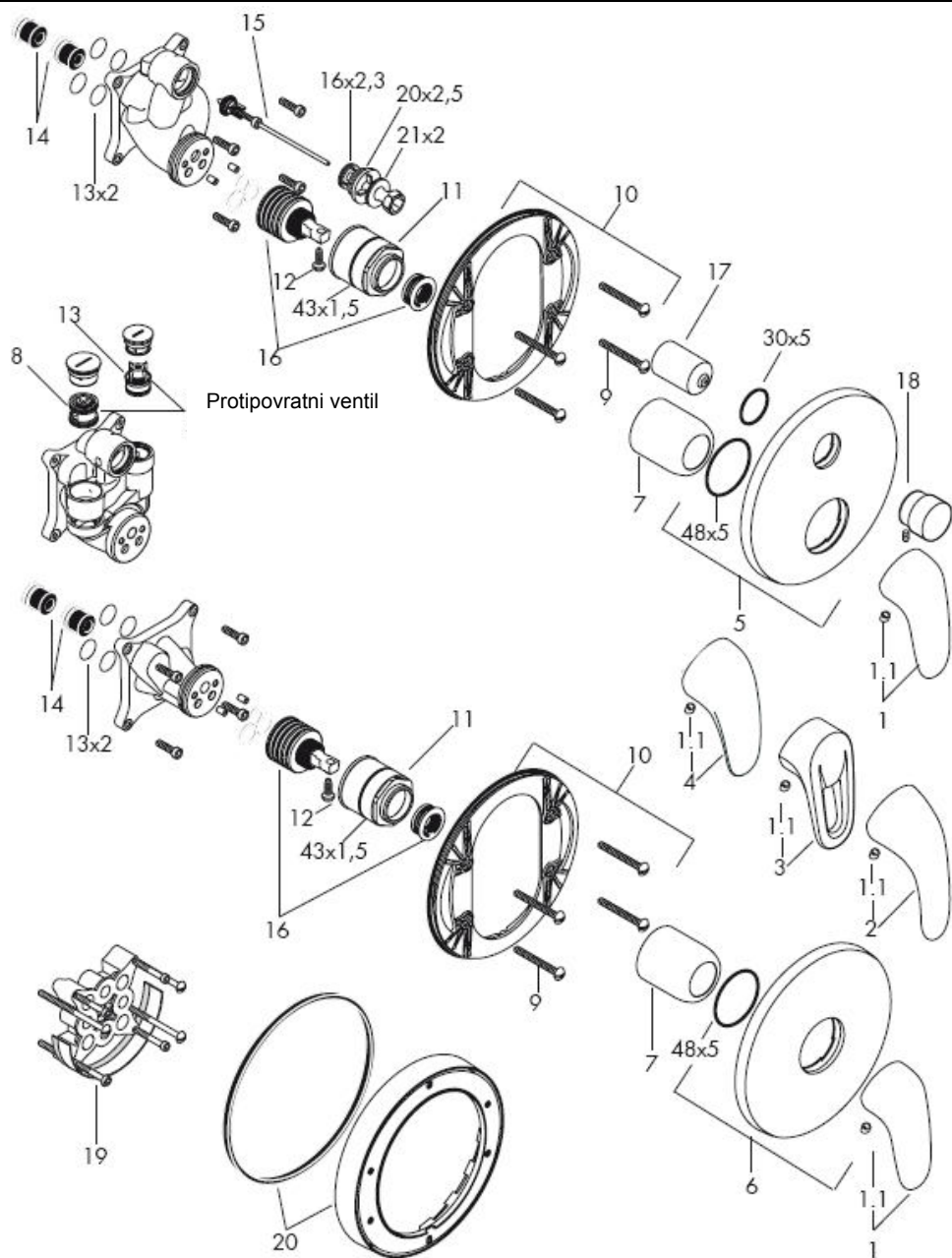

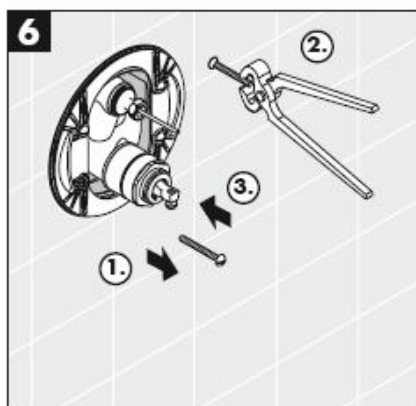
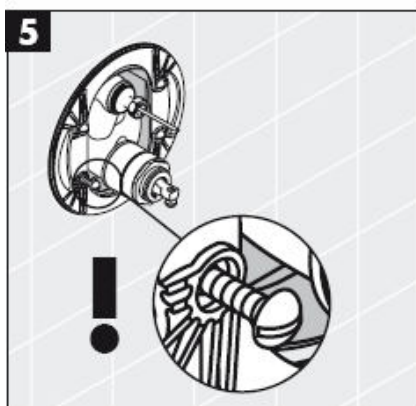
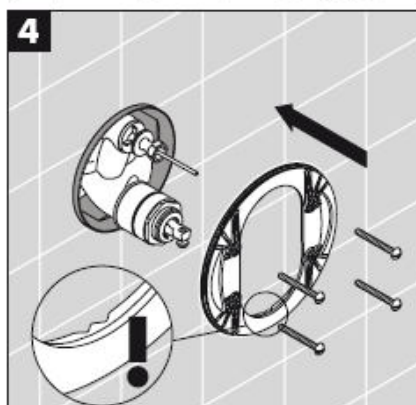
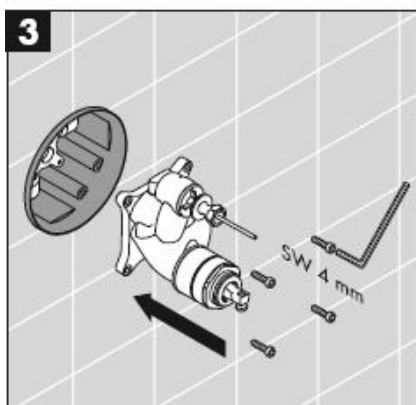
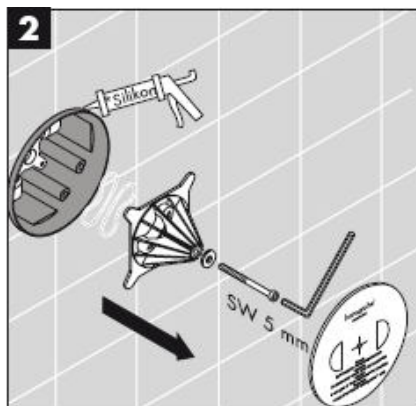
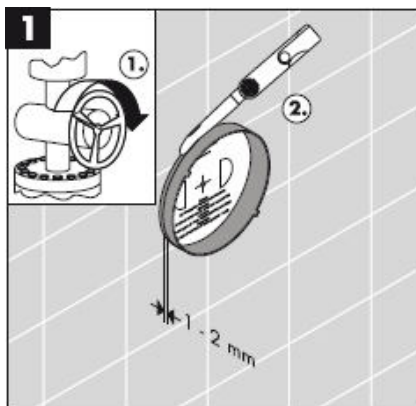

*Silikon (brez očetne kisline)

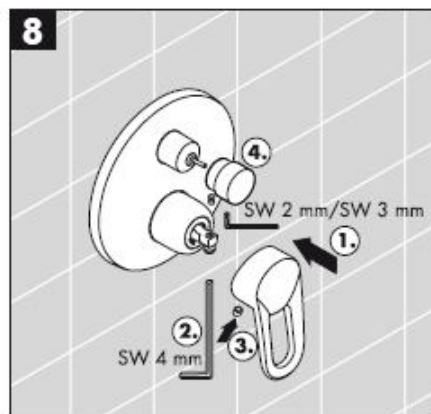
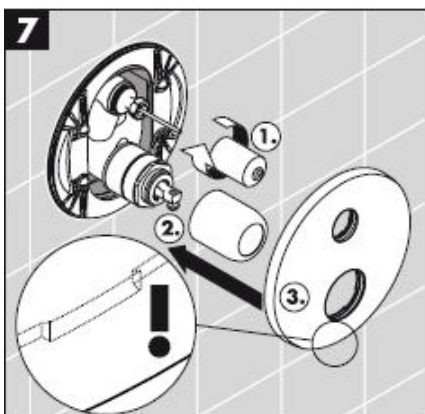

Montaža

Pozor! La robinetterie doit être installée, rincée et contrôlée conformément aux normes valables!

Upravljanje

Mešalno baterijo odprete tako, da povlečete ročko.

Zasuk na levo = topla voda, na desno = hladna voda.

Na ročno prho preklonite tako, da povlečete za prekopni gumb. Po zaprtju ročke se avtomatsko vzpostavi prejšnje stanje.

Tehnični podatki

Delovni tlak:	max. 1 MPa
Priporočeni delovni tlak:	0,1 – 0,5 MPa
Preskusni tlak:	1,6 MPa
(1 MPa = 10 bar = 147 PSI)	
Temperatura tople vode:	max. 80° C
Priporočena temperatura tople vode:	65° C
Pretok vode: 0,3 MPa	
14475XXX / 14477XXX /	
31475000 / 31476000 /	
31744000 / 33455000 / 33457000:	
Odvod Kopalna kad	ca. 30 l/min
Odvod Prha	ca. 24 l/min
14675XXX / 31675000 /	
31761000 / 33665000:	ca. 32 l/min
Zaščita proti povratnemu toku:	14477XXX
	31476000
	33457000

Enoročne mešalne baterije Hansgrohe lahko uporabljate v povezavi s hidravlično in termično uravnavanimi pretočnimi grelniki, če je pretočni tlak najmanj 0,15 MPa.

Enoročne mešalne baterije z omejevalnikom tople vode, za justiranje glejte stran 8.

V povezavi s pretočnimi grelniki zapora tople vode ni potrebna.

Zapore za toplo vodo ne smete vgrajevati v povezavi s pretočnimi grelniki!

Pri okvari delov iboxa lahko pride do izteka vode, zato ibox montiramo nad kadjo. Tako lahko voda odteka v kad!

delovanje varnostnih naprav armatur 14477XXX/31476000/33457000 je potrebno enkrat letno testirati.

Delovanje protipovratnega ventila je potrebno v skladu z DIN EN 1717 in skladno z državnimi in regionalnimi določili (DIN 1988 enkrat letno) redno testirati.

Rezervni deli glejte stran 3

1	Ročka Metris E	31094XXX
1.1	Pokrov/čep	96338000
2	Ročka Focus E	31791000
3	Ročka Metropol E	14094XXX
4	Ročka Talis E	33091000
5	Rozeta	96453XXX
6	Rozeta	96452XXX
7	Krogelna rozeta E	95010XXX
8	Odzračevalnik cevi	96753000
9	Nosilni vijaki (4)	96454000
10	Nosilna rozeta	96447000
11	Matica	95007000
12	Zaščitni vijak	96059000
13	Protipovratni ventil	96655000
14	Dušilnik zvoka	94073000
15	Prekopna ročica kpl.	95014000
16	Vložek	92730000
17	Prekopna obojka	96448000
18	Potezalka	95013XXX
19	Podaljšek 25 mm	13595000
20	Podaljšek 22 mm	13596000

XXX = Barve

000 krom

090 krom/zlata

Preskusni znak

	DVGW	P-IX	SVGW	NF	WRAS	KIWA
14475XXX	X	PA-IX 9709/ICC	X		X	
14477XXX		PA-IX 18097/IDC				
14675XXX	X	PA-IX 9710/IB	X		X	
31475000	X	PA-IX 9709/ICC	X		X	
31476000		PA-IX 18097/IDC				
31675000	X	PA-IX 9710/IB	X			
31744000	X	PA-IX 9709/IDC	X			
31761000	X	PA-IX 9710/IB	X		X	
33455000	X	PA-IX 9709/IDC	X	X	X	X
33457000	X	PA-IX 18097/IDC	X	X		
33655000	X	PA-IX 9710/IB	X	X		X

Napaka

Vzrok

Pomoč

Teško premikanje armature Iz armature kaplja	-Pokvarjen vložek, poapneno -Pokvarjen vložek, usedline	-Zamenjajte vložek -Zamenjajte vložek
Preklopnik ne deluje	-Prenizek vodni tlak -Preklopnik je pokvarjen	-Povečajte vodni tlak -Zamenjajte preklopnik
Prenizka temperatura tople vode, ni mrzle vode. Pretočni grelnik se sproži, kadar izberete mrzlo vodo.	-Omejevalnik tople vode ni pravilno nastavljen -Križni tok	-Nastavite omejevalnik tople vode -Zamenjajte vložek

Omejitev tople vode: temperatura tople vode 60 °C, temperatura mrzle vode 10 °C, pretočni tlak 0,3 MPa.

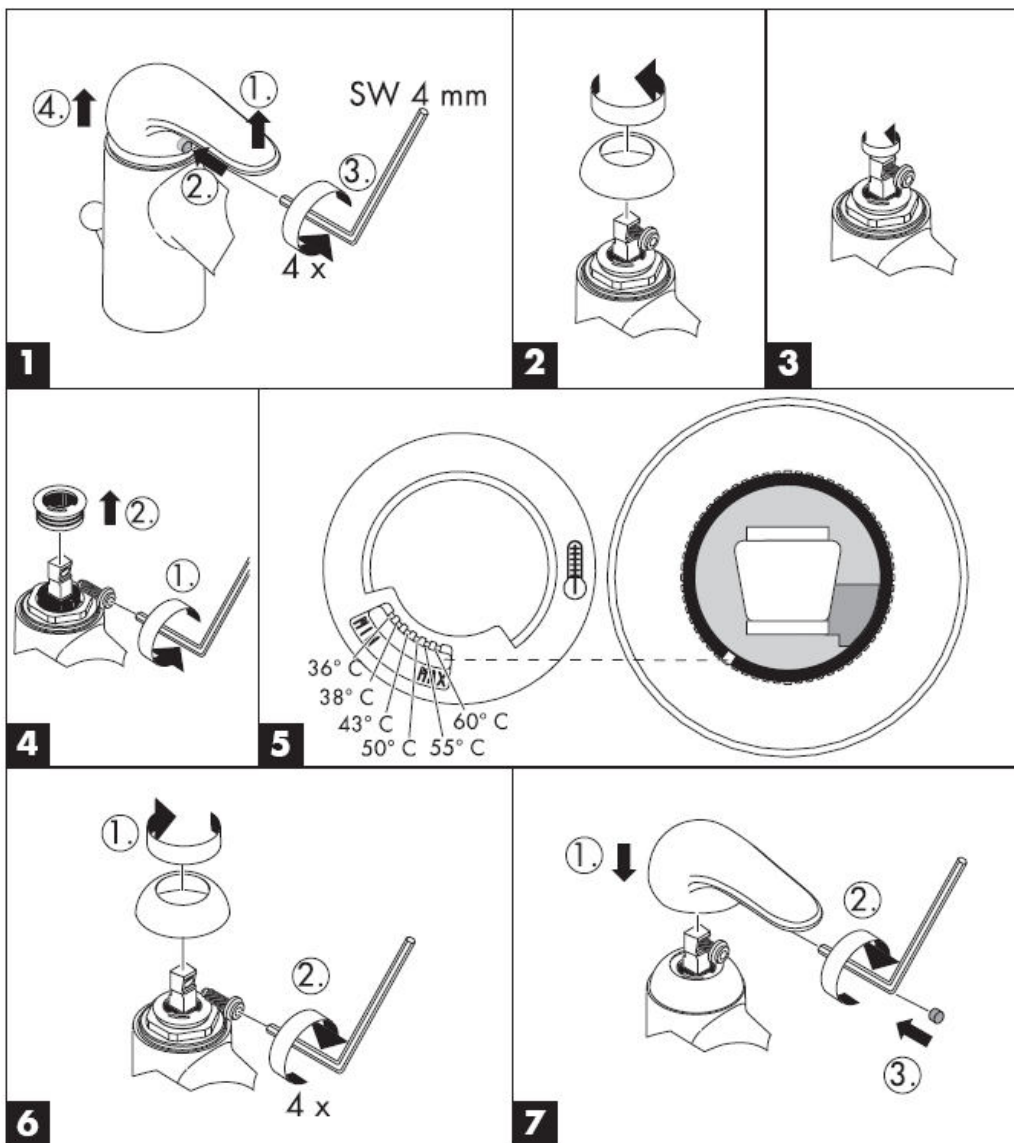

Paigaldusjuhend



Metropol E
14475XXX/
14477XXX



Metris E
31475000/
31476000



Focus E
31744000



Talis E
33455000/
33457000



Metropol E
14675XXX



Metris E
31675000



Focus E
31761000



Talis E
33655000

hansgrohe

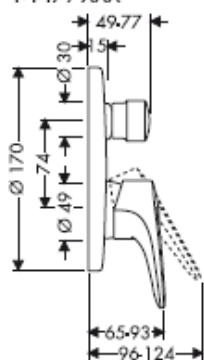
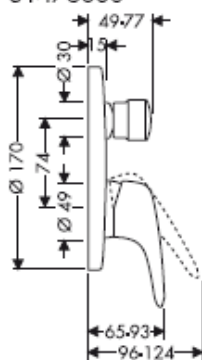
Metropol E14475XXX/
14477XXX**Metris E**31475000/
31476000**Focus E**

31744000

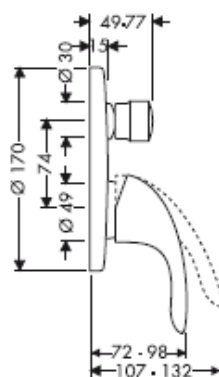
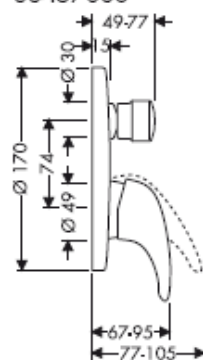
**Talis E**33455000/
33457000**Metropol E**

14675XXX

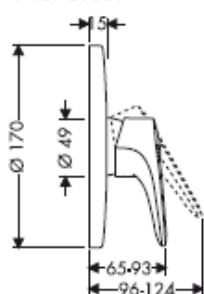
**Metris E**

31675000

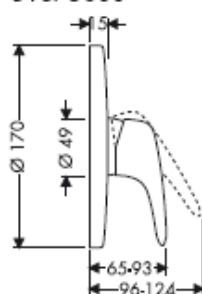
**Focus E**

31761000

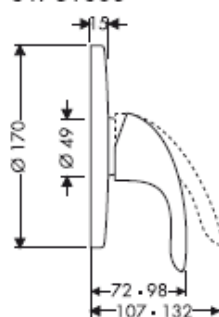
**Talis E**

33655000

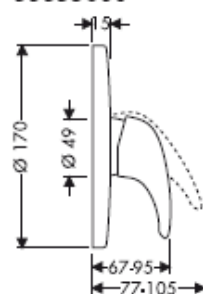

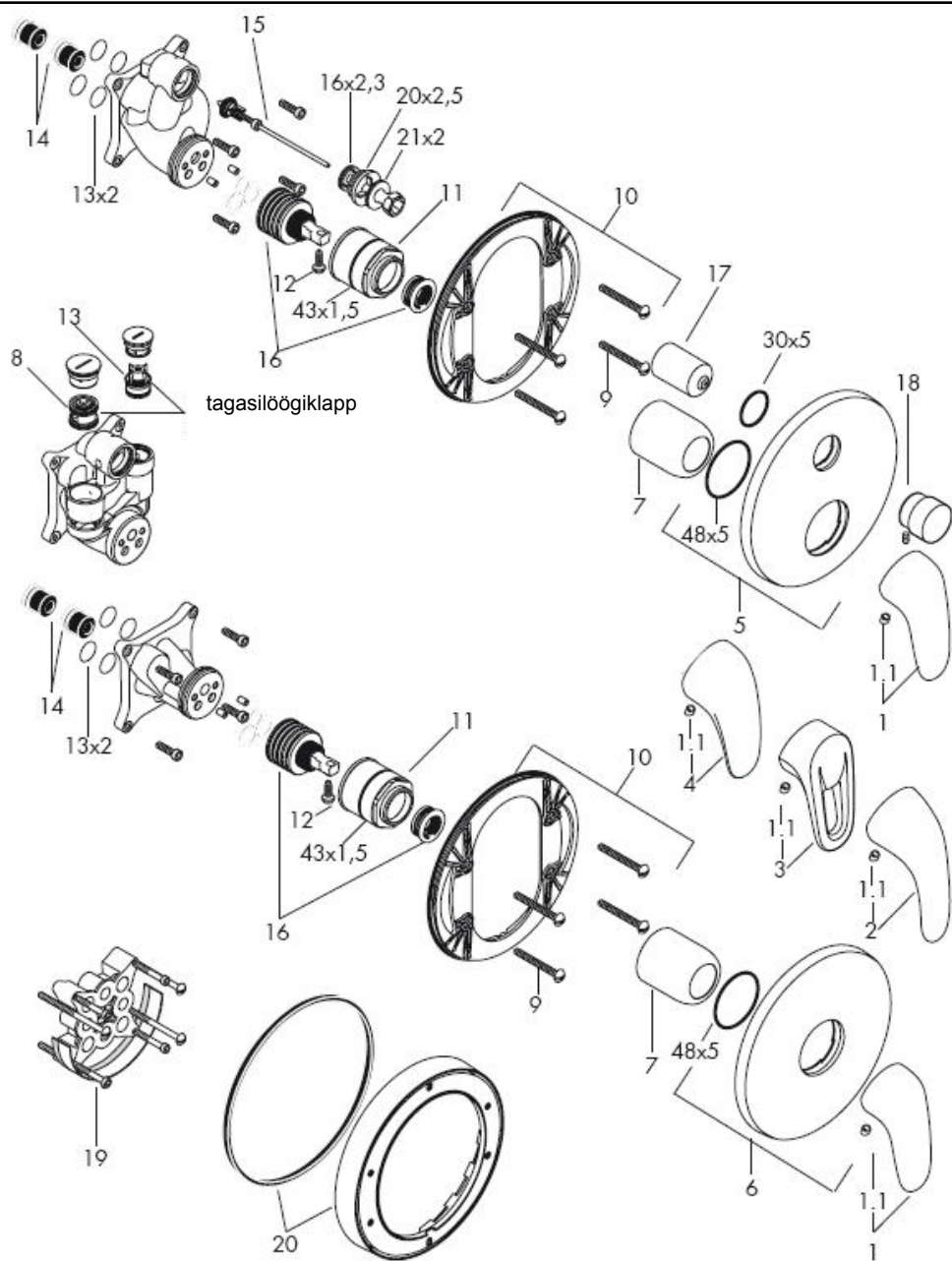

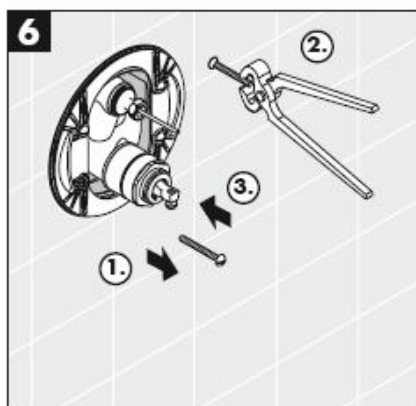
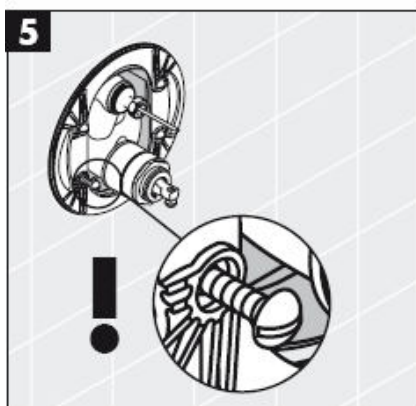
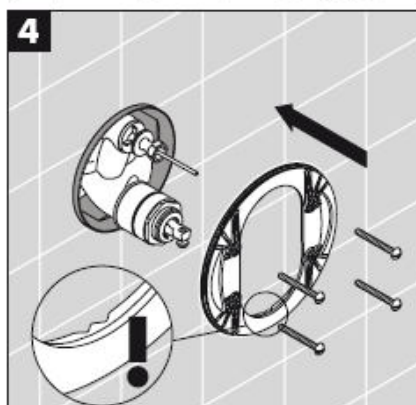
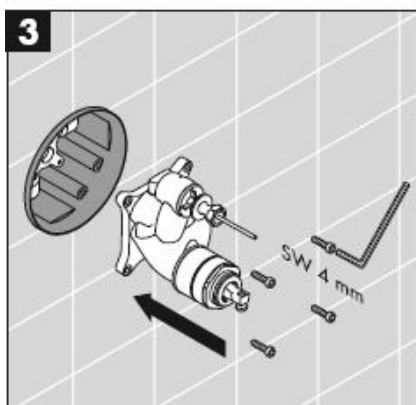
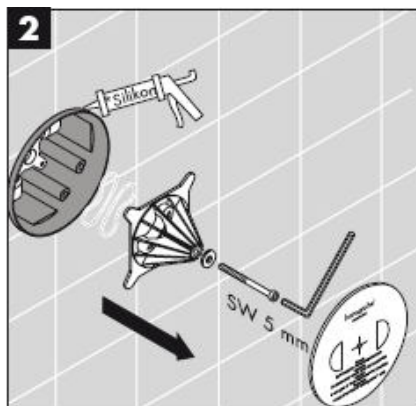
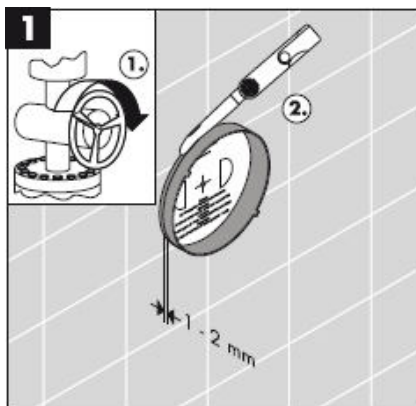

*Silikoon (äädikhappeta!)

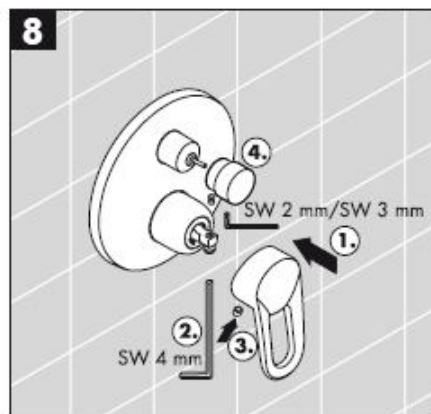
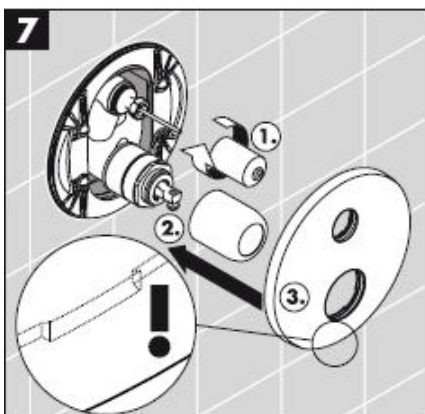

Paigaldamine

Tähelepanu! Segisti paigaldamine, loputamine ja kontroll peab toimuma vastavalt kehtivatele normidele!

Kasutamine

Segisti aktiveerub kangi tõmbamisega. Pööramine vasakule = soe vesi, paremal = külm vesi.

Käsidušile üleminek toimub ümberlülitusnupu tõmbamisega. Tavarežiimile üleminek toimub automaatselt käepideme sulgemisega.

Tehnilised andmed

Töörõhk	max. 1 MPa
Soovitav töörõhk:	0,1 – 0,5 MPa
Kontrollsurve:	1,6 MPa
(1 MPa = 10 baari = 147 PSI)	
Kuuma vee temperatuur:	max. 80° C
Soovitav kuuma vee temperatuur:	65° C
Läbivool: 0,3 MPa	
14475XXX / 14477XXX /	
31475000 / 31476000 /	
31744000 / 33455000 / 33457000:	
väljavool Vann	ca. 30 l/min
väljavool Dušš	ca. 24 l/min
14675XXX / 31675000 /	
31761000 / 33665000:	ca. 32 l/min
tagasivooluklapp:	14477XXX
	31476000
	33457000

Hansgrohe ühekäe segisteid võib kasutada koos hüdrauliliselt ja termiliselt juhitavate boileritega, kui vee rõhk on vähemalt 0,15 MPa.

Ühe juhtkangiga segisti kuuma vee piiraja reguleerimise kohta vt lk 8. Läbivoolu boilerite puhul pole reguleerimine vajalik.

Boilerite kasutamisel ei tohi kuuma vee tõkestit paigaldada.

Paigaldage ibox alati vanni kohale. Kui ibox'i osad lähevad katki, võib vesi vanni voolata!

Segistite ohutusseadmete
14477XXX/31476000/33457000 korrasolekut
peab kontrollima kord aastas.

Tagasilöögiklappide toimimist tuleb kooskõlas riiklike ja regionaalsete määrustega regulaarselt kontrollida vastavalt standardile DIN EN 1717 (DIN 1988 - kord aastas).

Varuosad vt lk 3

1	käepide Metris E	31094XXX
1.1	käepideme kaas	96338000
2	käepide Focus E	31791000
3	käepide Metropol E	14094XXX
4	käepideTalis E	33091000
5	äärrik	96453XXX
6	äärrik	96452XXX
7	kuuläärrik E	95010XXX
8	toruõhutaja	96753000
9	kinnituskravid (4)	96454000
10	alusplaat	96447000
11	mutter	95007000
12	käepideme kinnituskruvi	96059000
13	tagasilöögiklapp	96655000
14	helisummutus	94073000
15	muundur kpl.	95014000
16	tööelement	92730000
17	muunduri hülss	96448000
18	tõmbenupp	95013XXX
19	Pikendus 25 mm	13595000
20	Pikendus 22 mm	13596000

XXX = Värvikood

000 kroom
090 kroom/kuldne

Estonia

Kontrollsertifikaat

	DVGW	P-IX	SVGW	NF	WRAS	KIWA
14475XXX	X	PA-IX 9709/ICC	X		X	
14477XXX		PA-IX 18097/IDC				
14675XXX	X	PA-IX 9710/IB	X		X	
31475000	X	PA-IX 9709/ICC	X		X	
31476000		PA-IX 18097/IDC				
31675000	X	PA-IX 9710/IB	X			
31744000	X	PA-IX 9709/IDC	X			
31761000	X	PA-IX 9710/IB	X		X	
33455000	X	PA-IX 9709/IDC	X	X	X	X
33457000	X	PA-IX 18097/IDC	X	X		
33655000	X	PA-IX 9710/IB	X	X		X

Rike	Põhjus	Lahendus
Segisti käib raskelt	-Tööelement on katkine, lubjastunud	-Vahetage tööelement
Segisti tilgub	-Tööelement on katkine, sete	-Vahetage tööelement
Ümberlüli ei tööta	-Vee surve liiga madal -Ümberlüli defektne	-Tõstke vee survet -Ümberlüli välja vahetada
Liiga madal sooja vee temperatuur, külma vett pole.	-Kuuma vee piirang valesti seatud	-Seadke kuuma vee piirang
Läbivoolu boiler hakkab tööle, kui on valitud külm vesi.	-Ristvool	-Vahetage tööelement

Kuuma vee piiraja: kuum vesi 60 C, külm vesi 10 C, rõhk 0,3 MPa.

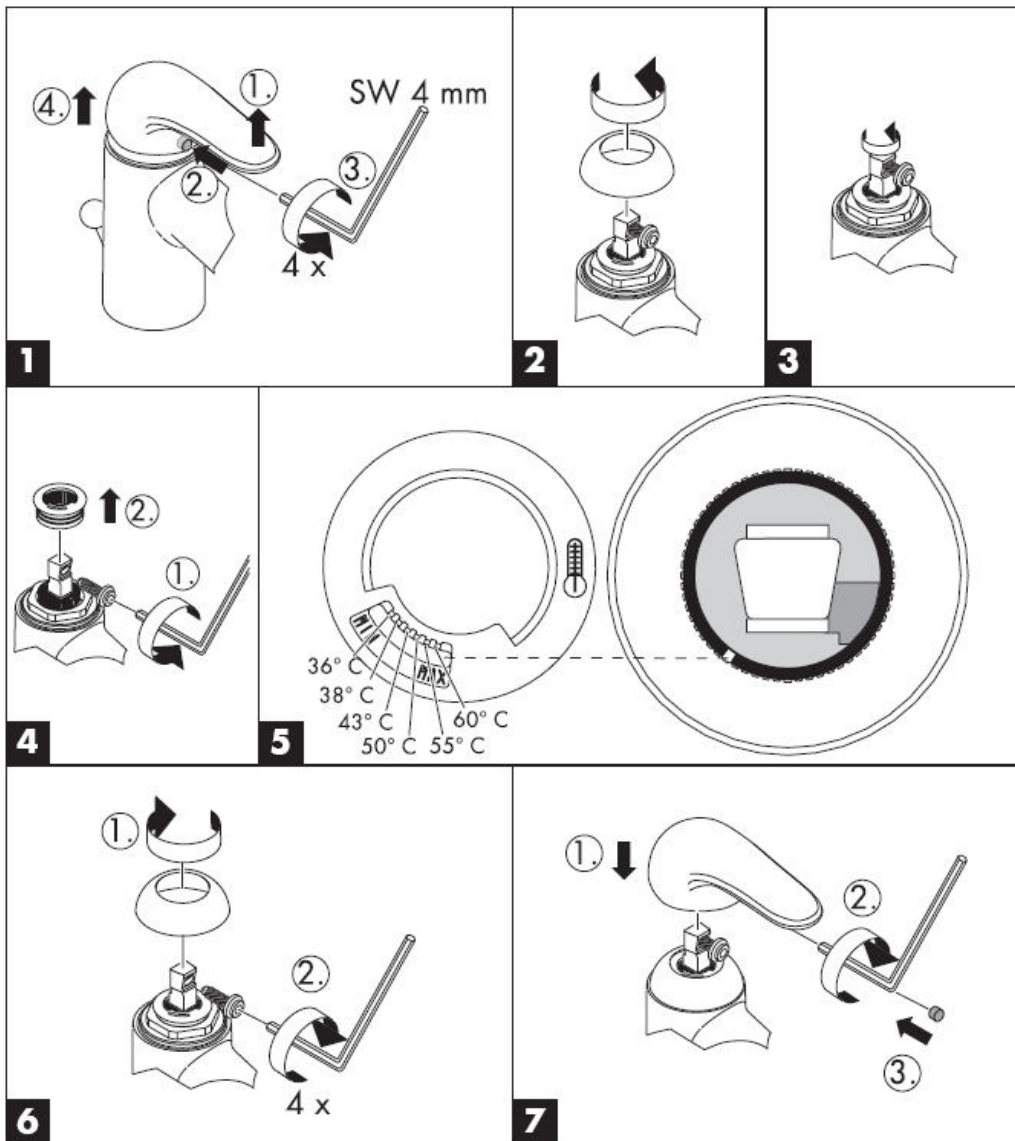

Montāžas instrukcija



Metropol E
14475XXX/
14477XXX



Metris E
31475000/
31476000



Focus E
31744000



Talis E
33455000/
33457000



Metropol E
14675XXX



Metris E
31675000



Focus E
31761000



Talis E
33655000

hansgrohe

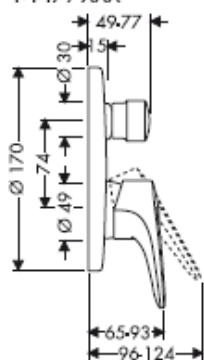
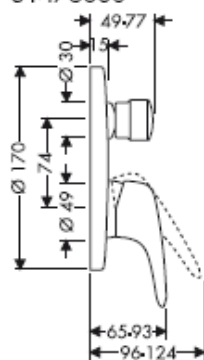
Metropol E14475XXX/
14477XXX**Metris E**31475000/
31476000**Focus E**

31744000

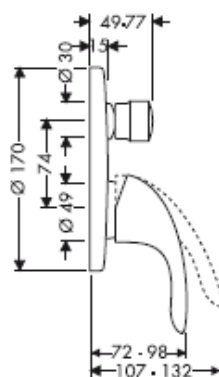
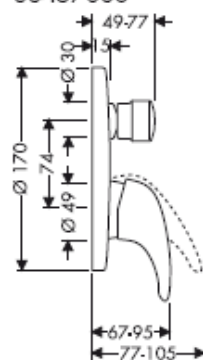
**Talis E**33455000/
33457000**Metropol E**

14675XXX

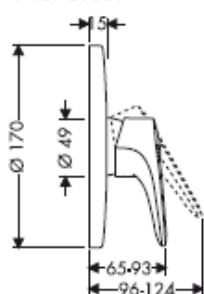
**Metris E**

31675000

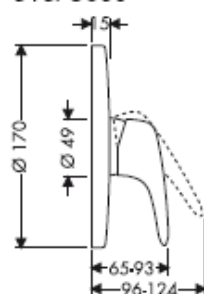
**Focus E**

31761000

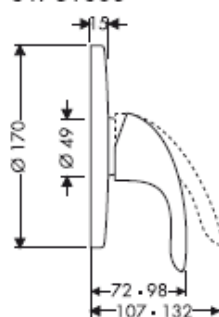
**Talis E**

33655000

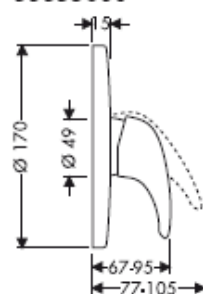

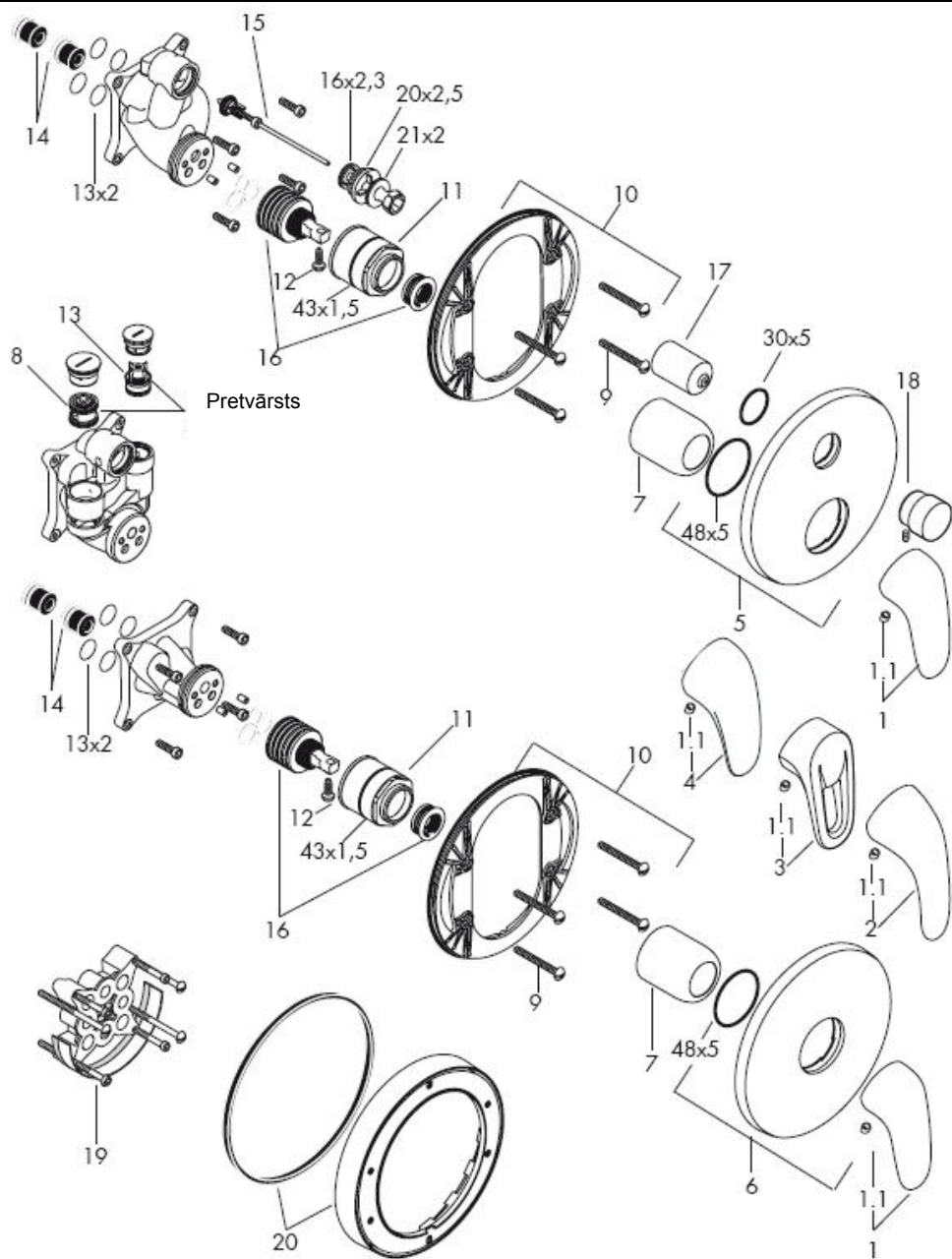

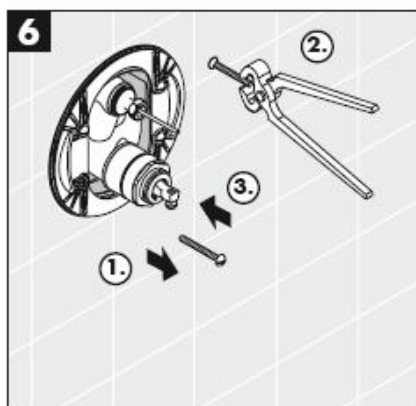
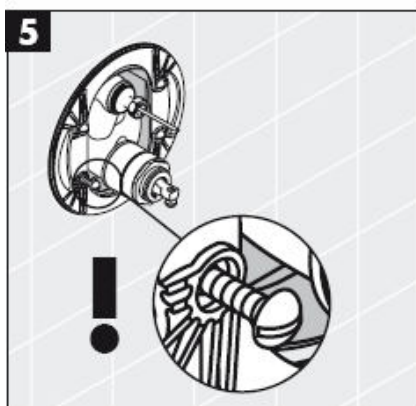
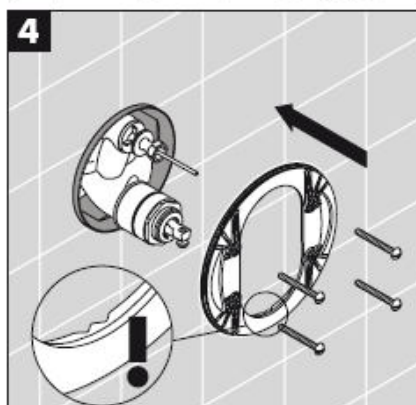
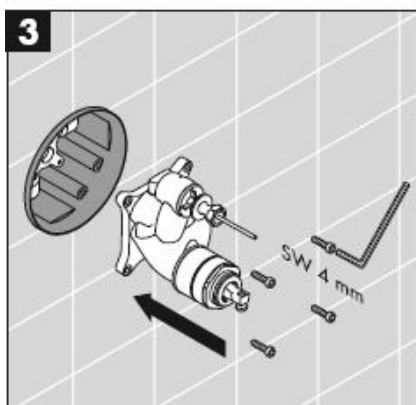
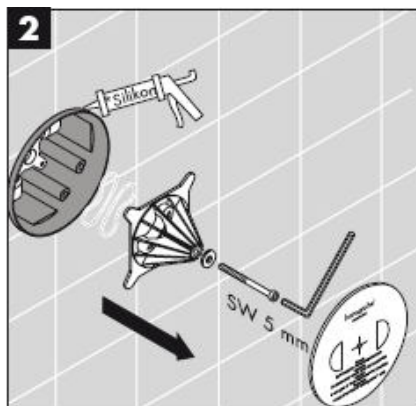
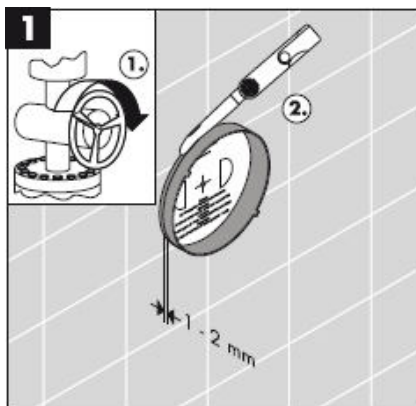

*Silikons (etiķskābi nesaturošs!)

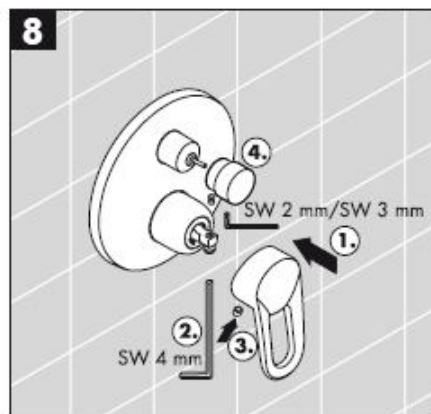
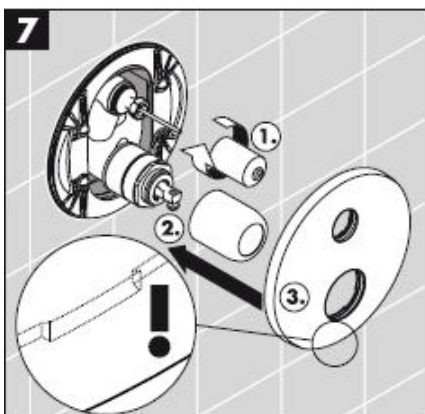

Montāža

Uzmanību! Armatūra jāuzstāda, jāizskalo un jāpārbauda atbilstoši spēkā esošajām normām!

Lietošana

Velkot rokturi, tiek atvērts jaucējkrāns. Pagrieziena pa kreisi = siltais ūdens, pa labi = aukstais ūdens. Pārslēgšana uz rokas dušu notiek, velkot aiz pārslēdzējapogas. Atgriešanās iepriekšējā pozīcijā notiek automātiski, aizgriežot rokturi.

Tehniskie dati

Darba spiediens:	max. 1 MPa
leteicamais darba spiediens:	0,1 – 0,5 MPa
Pārbaudes spiediens:	1,6 MPa
(1 MPa = 10 bar = 147 PSI)	
Karstā ūdens temperatūra:	max. 80° C
leteicamā karstā ūdens temperatūra:	65° C
Caurteces intensitāte: 0,3 MPa	
14475XXX / 14477XXX /	
31475000 / 31476000 /	
31744000 / 33455000 / 33457000:	
Izteka Vanna	ca. 30 l/min
Izteka Duša	ca. 24 l/min
14675XXX / 31675000 /	
31761000 / 33665000:	ca. 32 l/min
Drošības vārsts:	14477XXX
	31476000
	33457000

Hansgrohe viensvires jaucējkrānus var izmantot kombinācijā ar hidrauliski un termiski vadāmiem caurteces sildītājiem, ja plūsmas spiediens ir vismaz 0,15 MPa.

Viensvires jaucējkrāns ar siltā ūdens ierobežošanu, ieregulēšanu skat. 8. lpp. Kombinācijā ar caurteces sildītāju karstā ūdens ierobežošana nav nepieciešama.

Kombinācijā ar caurteces sildītāju nedrīkst būt iebūvēts karstā ūdens ierobežotājs.

Tā kā funkcionālo detaļu bojājuma gadījumā no i-box daļas var izplūst ūdens, i-box jāmontē virs vannas, lai izplūstošais ūdens varētu notecēt vannā!

Reizi gadā jāpārbauda jaucējkrānu drošības elementu 14477XXX/31476000/33457000 funkcija.

Regulāri jāpārbauda pretvārsta funkcija saskaņā ar DIN EN 1717 saistībā ar nacionālajiem vai vietējiem noteikumiem (DIN 1988 vienreiz gadā).

Rezerves daļas skat. lpp. 3

1	rokturis Metris E	31094XXX
1.1	dekoratīvs aizbāznis	96338000
2	rokturis Focus E	31791000
3	rokturis Metropol E	14094XXX
4	rokturis Talis E	33091000
5	Rozete	96453XXX
6	Rozete	96452XXX
7	Lodveida rozete E	95010XXX
8	Ventilācijas cauruļvads	96753000
9	Fiksācijas skrūves (4)	96454000
10	Balsta plāksne	96447000
11	uzgrieznis	95007000
12	Drošības skrūve	96059000
13	Pretvārsts	96655000
14	Skaņas slāpētājs	94073000
15	Pārslēdzēju kompl.	95014000
16	Kartuša, kompl.	92730000
17	Pārslēdzējuzmavas	96448000
18	Pārslēdzēja poga	95013XXX
19	Pagarinājums 25 mm	13595000
20	Pagarinājums 22 mm	13596000

XXX = Krāsas

000 hroma
090 hroma/zelta

Pārbaudes zīme

	DVGW	P-IX	SVGW	NF	WRAS	KIWA
14475XXX	X	PA-IX 9709/ICC	X		X	
14477XXX		PA-IX 18097/IDC				
14675XXX	X	PA-IX 9710/IB	X		X	
31475000	X	PA-IX 9709/ICC	X		X	
31476000		PA-IX 18097/IDC				
31675000	X	PA-IX 9710/IB	X			
31744000	X	PA-IX 9709/IDC	X			
31761000	X	PA-IX 9710/IB	X		X	
33455000	X	PA-IX 9709/IDC	X	X	X	X
33457000	X	PA-IX 18097/IDC	X	X		
33655000	X	PA-IX 9710/IB	X	X		X

Traucējums

Iemesis

Bojājumu novēršana

Jaucējkrāns smagi grozāms	-Bojāta kartuša, aizkalķojusies	-Nomainīt kartušu
Jaucējkrāns pil	-Bojāta kartuša, nogulsnes	-Nomainīt kartušu
Pārslēdzējs nestrādā	-Nepietiekams ūdens spiediens -Bojāts pārslēdzējs	-Paaugstināt ūdens spiedienu -Nomainīt pārslēdzēju
Pārāk zema ūdens temperatūra, nav aukstā ūdens, izvēloties auksto ūdeni, sāk darboties caurteces sildītājs	-Nepareizi noregulāta karstā ūdens bloķēšana -Ūdens sajaukšanās	-Noregulēt karstā ūdens ierobežošanu -Nomainīt kartušu

Karstā ūdens ierobežotājs: karstā ūdens temperatūra 60 C, aukstā ūdens temperatūra 10 C, plūsmas spiediens 0,3 MPa.

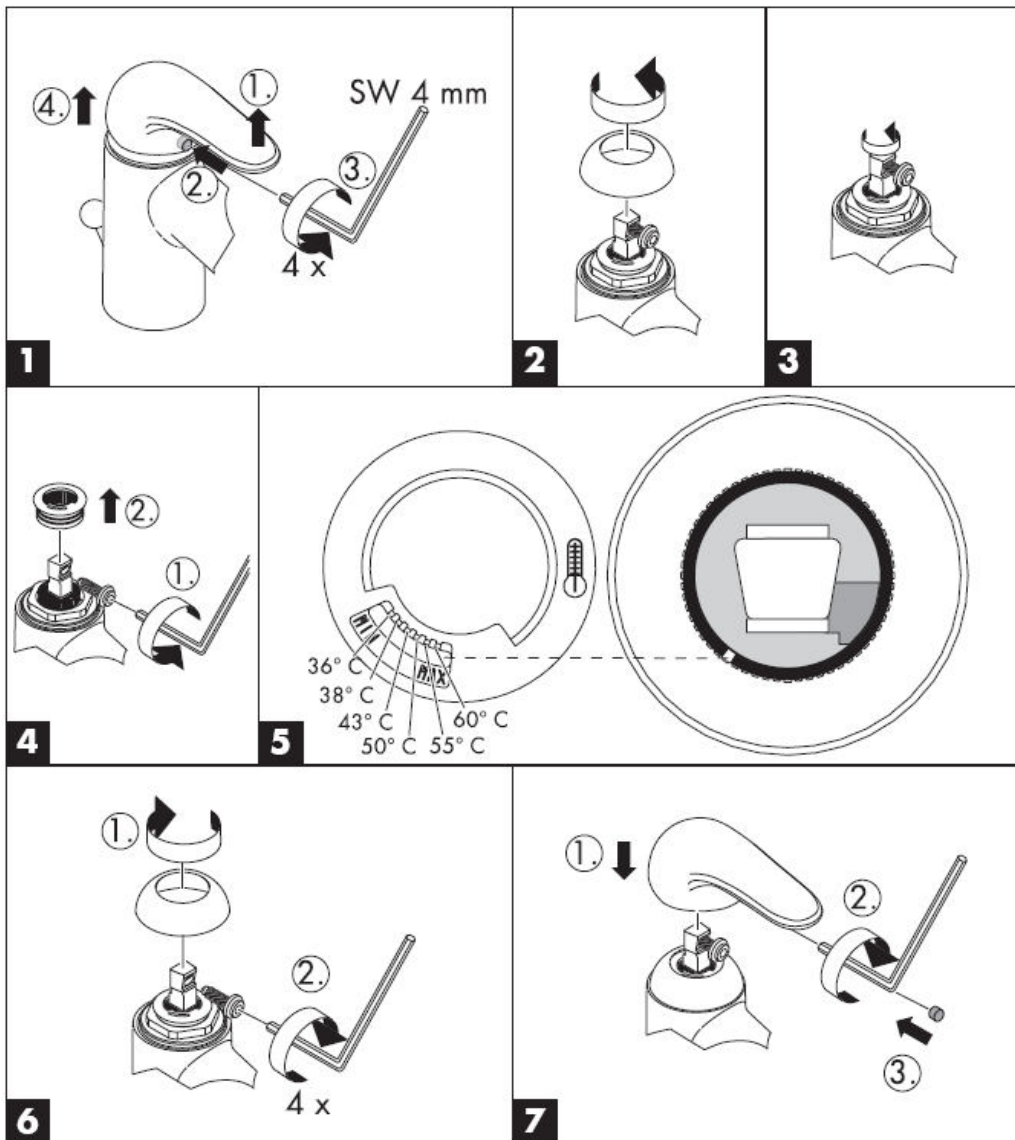

Uputstvo za montažu



Metropol E
14475XXX/
14477XXX



Metris E
31475000/
31476000



Focus E
31744000



Talis E
33455000/
33457000



Metropol E
14675XXX



Metris E
31675000



Focus E
31761000



Talis E
33655000

hansgrohe

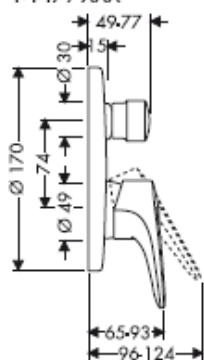
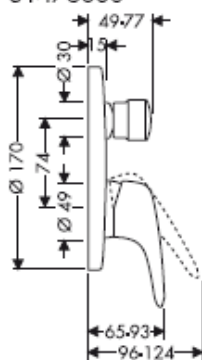
Metropol E14475XXX/
14477XXX**Metris E**31475000/
31476000**Focus E**

31744000

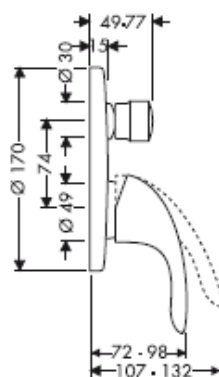
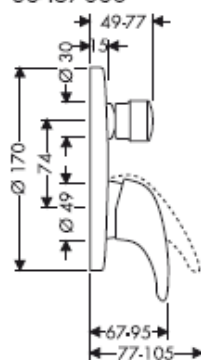
**Talis E**33455000/
33457000**Metropol E**

14675XXX

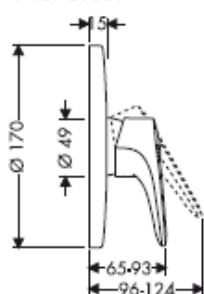
**Metris E**

31675000

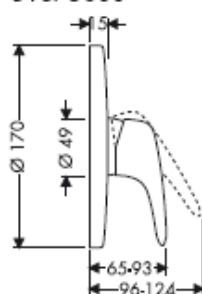
**Focus E**

31761000

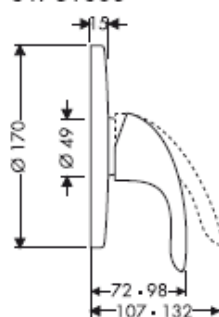
**Talis E**

33655000

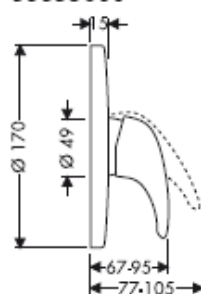

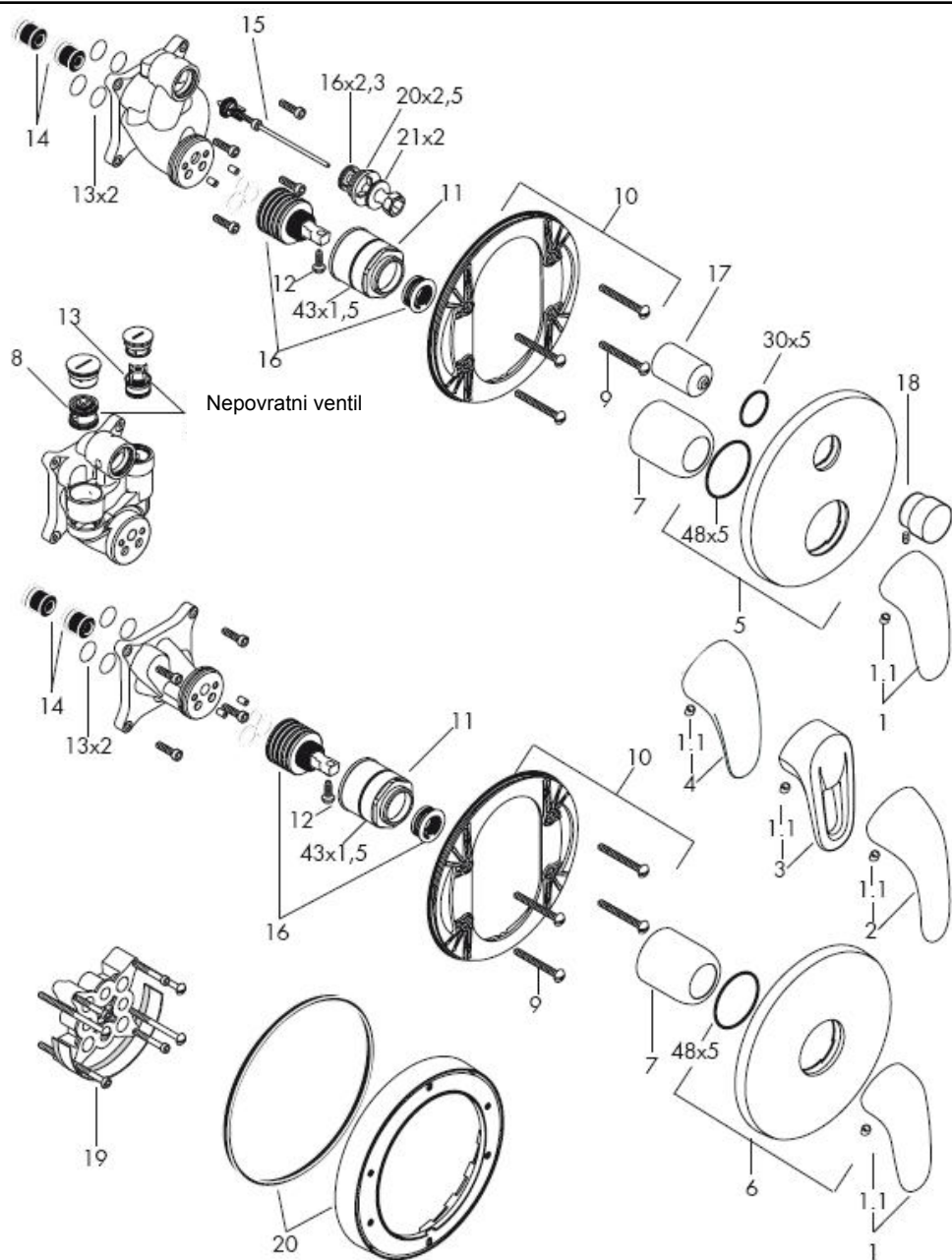

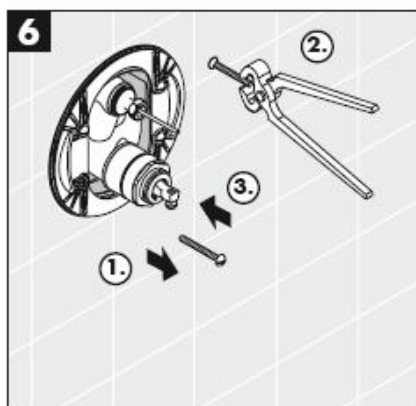
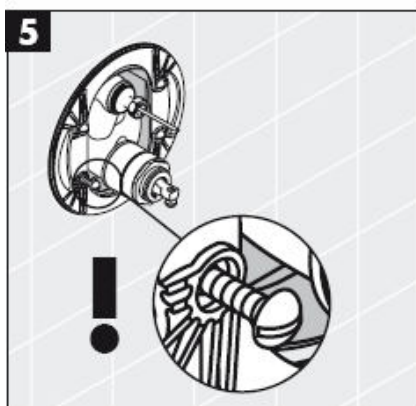
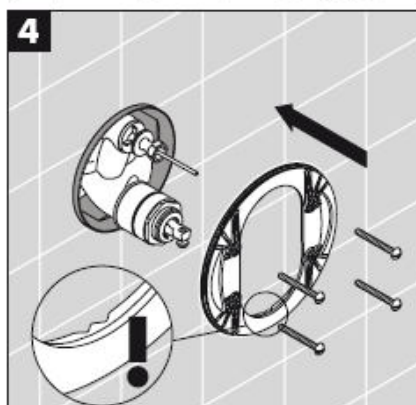
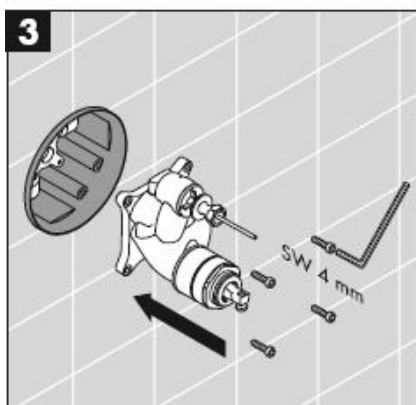
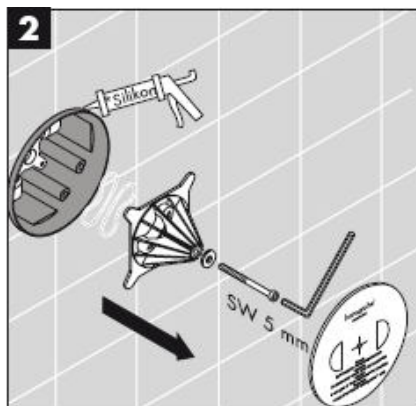
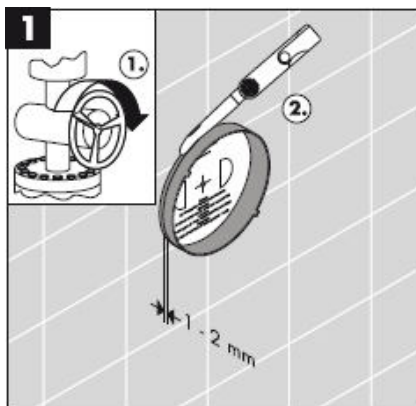

*Silikon (ne sadrži sirčetnu kiselinu!)

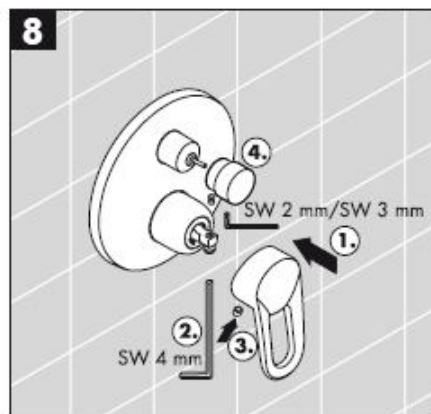
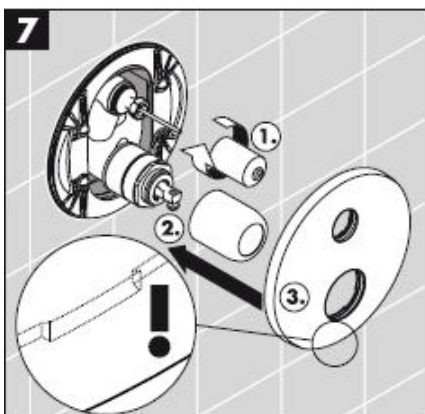

Montaža

Pažnja! Armatura mora biti postavljena, isprana i testirana prema važećim normama!

Rukovanje

Mešač se otvara podizanjem ručice.

Okretanje ulevo = topla voda, udesno = hladna voda.

Prebacivanje na ručni tuš se vrši povlačenjem dugmeta preusmerivača. Nakon zatvaranja ručice, automatski se uspostavlja početna situacija.

Tehnički podaci

Radni pritisak:	max. 1 MPa
Preporučeni radni pritisak:	0,1 – 0,5 MPa
Probni pritisak:	1,6 MPa
(1 MPa = 10 bara = 147 PSI)	
Temperatura vruće vode:	max. 80° C
Preporučena temperatura vruće vode:	65° C
Protok vode: 0,3 MPa	
14475XXX / 14477XXX /	
31475000 / 31476000 /	
31744000 / 33455000 / 33457000:	
izlaz Kada	ca. 30 l/min
izlaz Tuš	ca. 24 l/min
14675XXX / 31675000 /	
31761000 / 33665000:	ca. 32 l/min
Zaštita od povratnog toka:	14477XXX
	31476000
	33457000

Hansgrohe jednoručni mešači se mogu koristiti s hidraulički i termički kontrolisanim protočnim bojlerima, ako je pritisak najmanje 0,15 MPa.

Da bi ste podesili ograničavač vruće vode na jednoručnim mešačima, molimo Vas da pogledate stranicu 8.

Podešavanje nije potrebno ako koristite protočni bojler.

U kombinaciji s protočnim bojlerima ne sme se ugraditi sistem za blokiranje dotoka tople vode!

Pošto kod kvara pojedinih delova iz ibox-a može iscureti voda, ibox se mora instalirati iznad kade, tako da voda može oticati u kadu!

Sigurnosne elementi armature 14477XXX/31476000/33457000 moraju se proveravati jednom godišnje.

Ispravno funkcionisanje nepovratnog ventila se mora redovno proveravati prema standardu DIN EN 1717 i u skladu s važećim nacionalnim ili regionalnim propisima (DIN 1988 jednom godišnje).

Rezervni delovi vidi stranu 3

1	Ručica Metris E	31094XXX
1.1	Čepovi ručice	96338000
2	Ručica Focus E	31791000
3	Ručica Metropol E	14094XXX
4	Ručica Talis E	33091000
5	Rozeta	96453XXX
6	Rozeta	96452XXX
7	Loptasta rozeta E	95010XXX
8	Ventilacija cevi	96753000
9	Noseći zavrtnji (4)	96454000
10	Noseća rozeta	96447000
11	Navrtka	95007000
12	Sigurnosni zavrtanj	96059000
13	Nepovratni ventil	96655000
14	Prigušivač buke	94073000
15	Preusmerivač kompl.	95014000
16	Preusmerivač kompl.	92730000
17	Čaura preusmerivača	96448000
18	Potezno dugme	95013XXX
19	Produžetak 25 mm	13595000
20	Produžetak 22 mm	13596000

XXX = Oznake boja

000 hrom
090 hrom/zlatna

Srpski

Ispitni znak

	DVGW	P-IX	SVGW	NF	WRAS	KIWA
14475XXX	X	PA-IX 9709/ICC	X		X	
14477XXX		PA-IX 18097/IDC				
14675XXX	X	PA-IX 9710/IB	X		X	
31475000	X	PA-IX 9709/ICC	X		X	
31476000		PA-IX 18097/IDC				
31675000	X	PA-IX 9710/IB	X			
31744000	X	PA-IX 9709/IDC	X			
31761000	X	PA-IX 9710/IB	X		X	
33455000	X	PA-IX 9709/IDC	X	X	X	X
33457000	X	PA-IX 18097/IDC	X	X		
33655000	X	PA-IX 9710/IB	X	X		X

Smetnja

Uzrok

Pomoć

Ručica se zaglavila	-Neispravna kartuša, nataloženi kamenac	-Zamenite kartušu
Slavina kaplje	-Neispravna kartuša, naslage kamenca	-Zamenite kartušu
Preusmerivač ne radi	-Prenizak pritisak vode -Preusmerivač je neispravan	-Povećajte pritisak vode -Zamenite preusmerivač
Preniska temperatura tople vode, nema hladne vode. Protočni bojler se pali iako je puštena hladna voda.	-Ograničavač vruće vode nije dobro podešen -Ukršteni tok vode	-Podesite ograničavač vruće vode -Zamenite kartušu

Ograničavač vruće vode: temperatura vruće vode 60 °C, temperatura hladne vode 10 °C, pritisak 0,3 MPa.

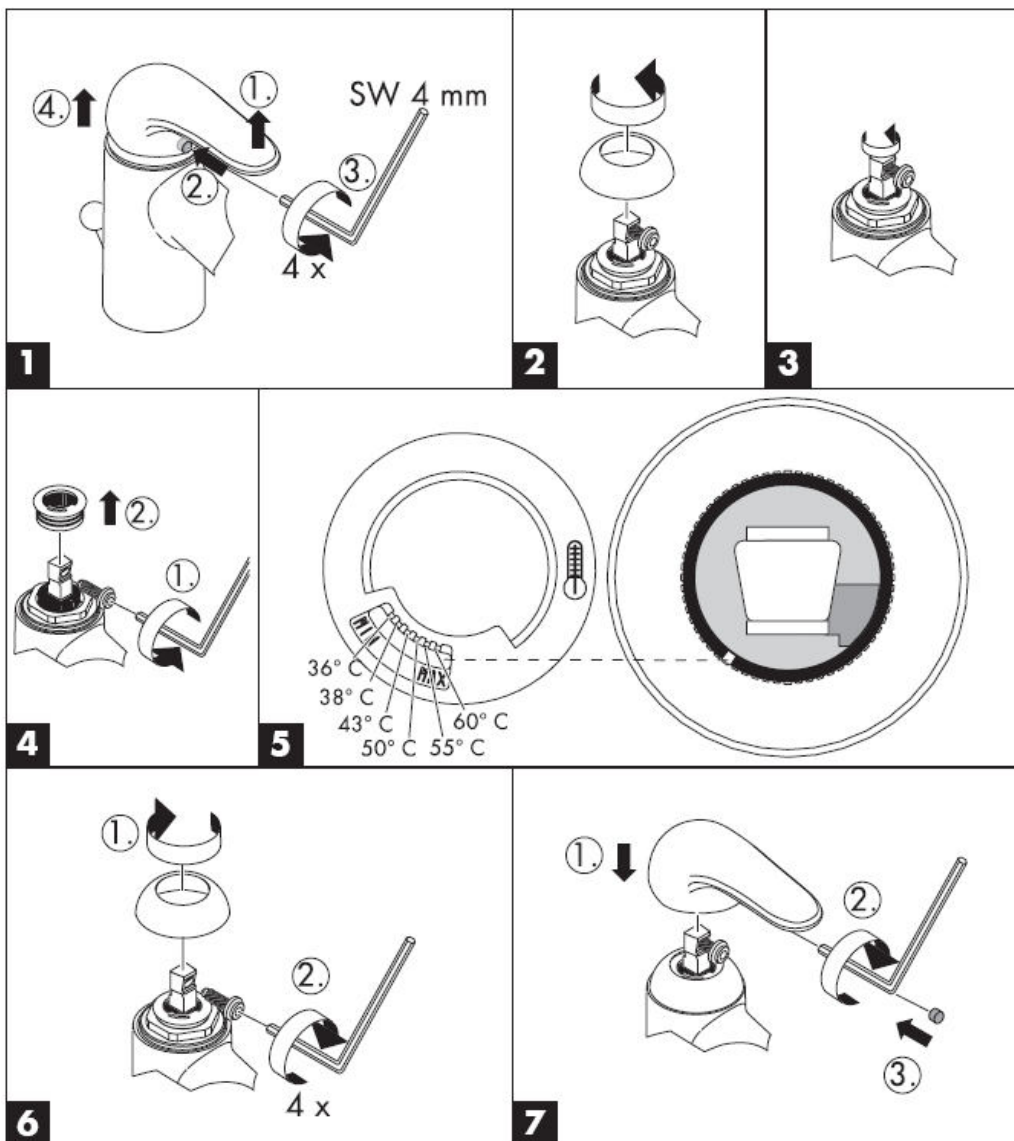

Montasjeveiledning



Metropol E
14475XXX/
14477XXX



Metris E
31475000/
31476000



Focus E
31744000



Talis E
33455000/
33457000



Metropol E
14675XXX



Metris E
31675000



Focus E
31761000



Talis E
33655000

hansgrohe

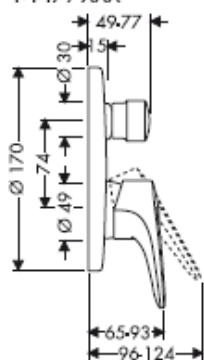
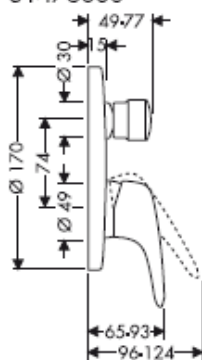
Metropol E14475XXX/
14477XXX**Metris E**31475000/
31476000**Focus E**

31744000

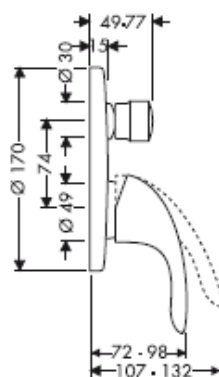
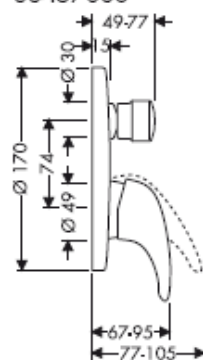
**Talis E**33455000/
33457000**Metropol E**

14675XXX

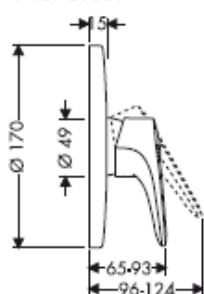
**Metris E**

31675000

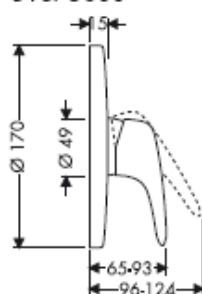
**Focus E**

31761000

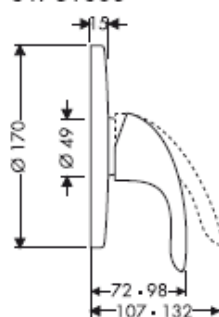
**Talis E**

33655000

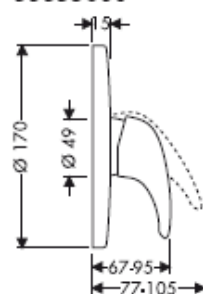

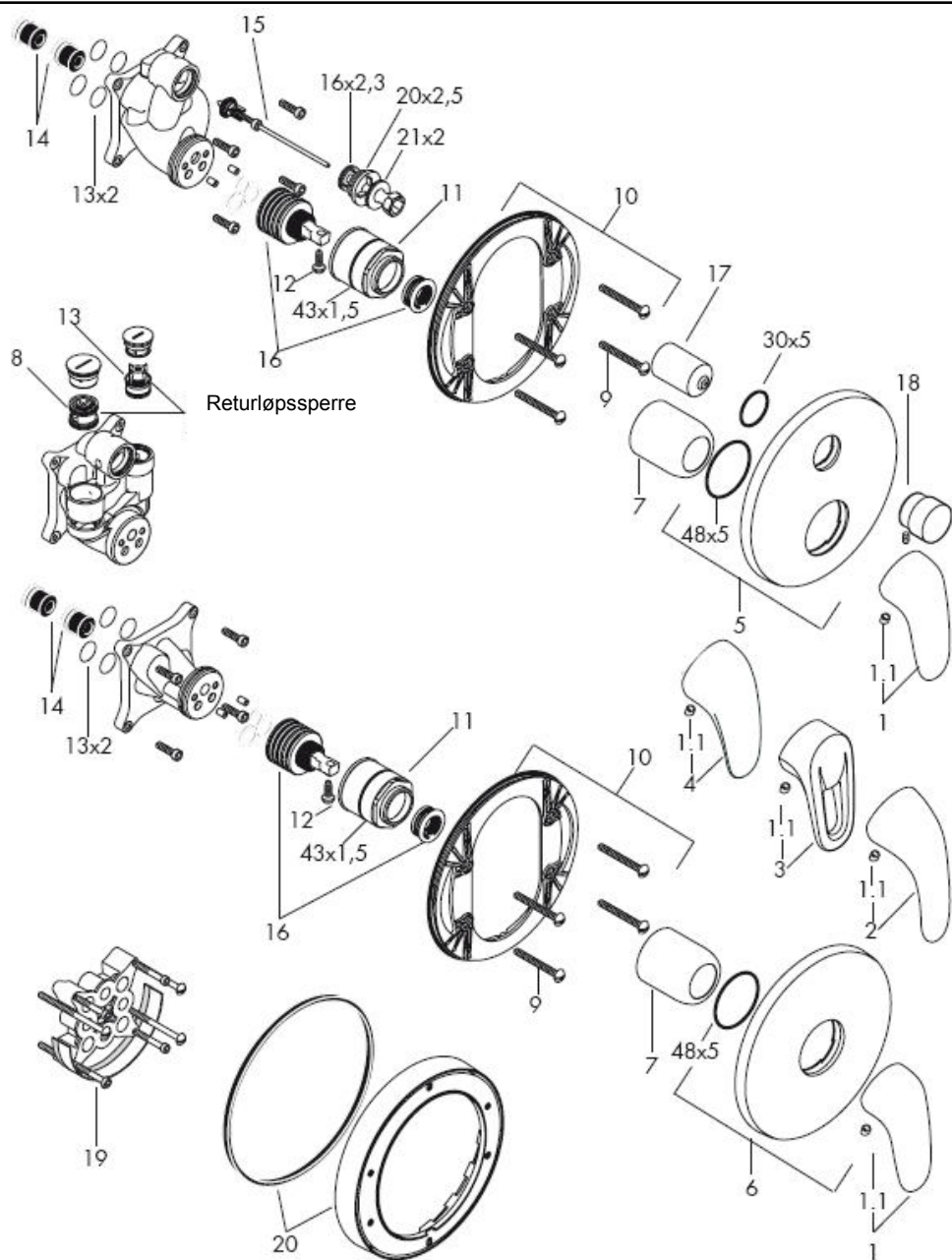

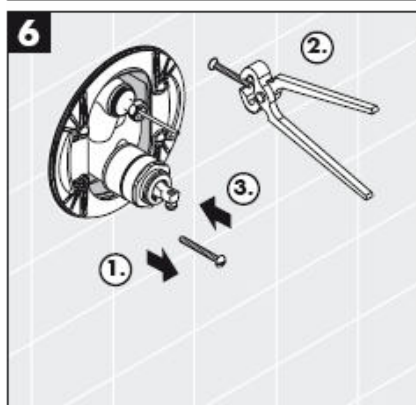
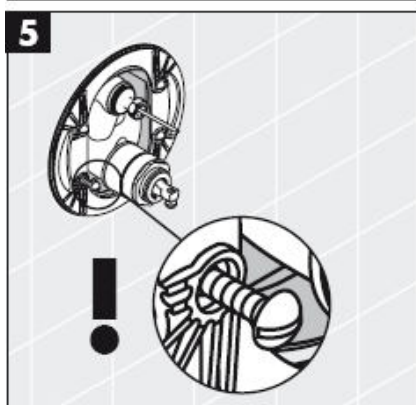
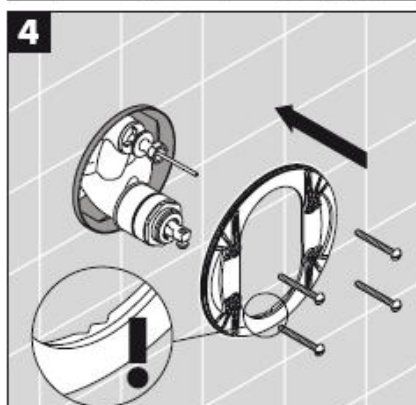
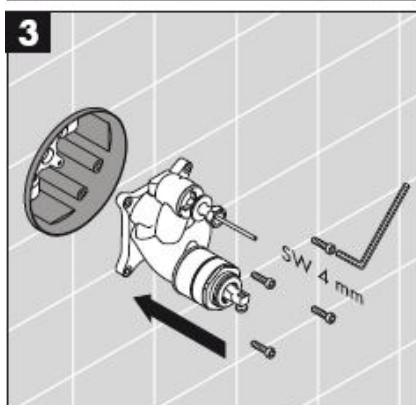
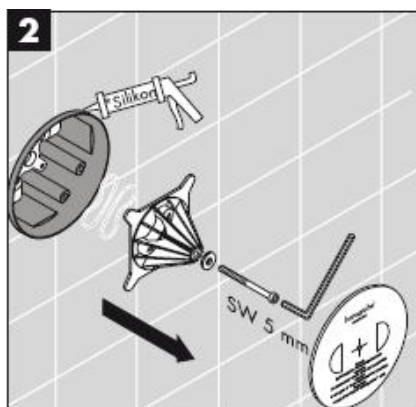
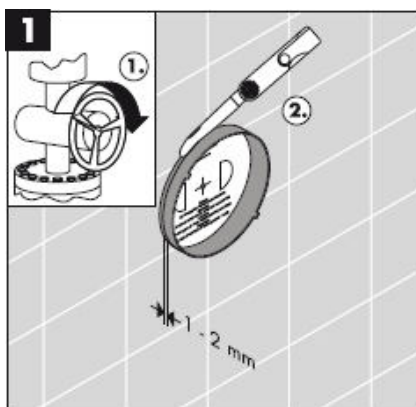

*Silikon (uten eddiksyre)

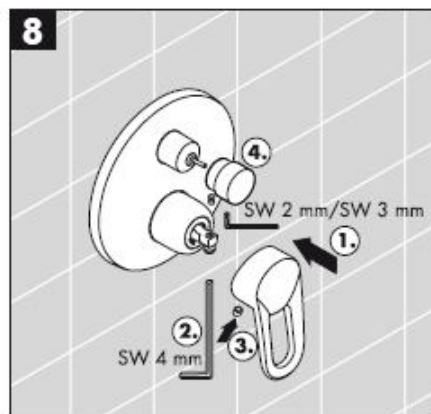
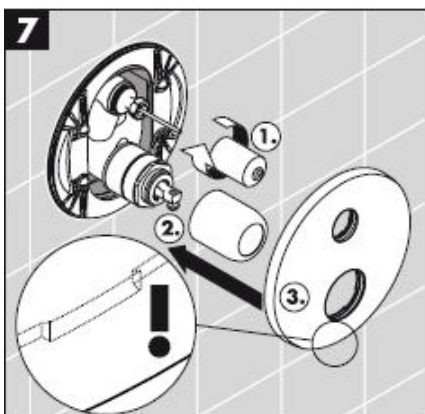

Montasje

Obs! Armaturen skal monteres iht. gyldige standarder. De skal spyles og sjekkes!

Betjening

Blandebatteriet åpnes ved å trekke i grepet. Sving til venstre = varmt vann, til høyre = kaldt vann

Omstilling på hånddusj ved å trekke i omstillingsknappen. Automatisk tilbakestilling skjer etter at grepet lukkes.

Tekniske data

Driftstrykk	max. 1 MPa
Anbefalt driftstrykk:	0,1 – 0,5 MPa
Prøvetrykk	1,6 MPa
(1 Mpa = 10 bar = 147 PSI)	
Varmtvannstemperatur	max. 80° C
Anbefalt temperatur for varmt vann	65° C
Gjennomstrømningsytelse: 0,3 MPa	
14475XXX / 14477XXX /	
31475000 / 31476000 /	
31744000 / 33455000 / 33457000:	
Utgang Badekar	ca. 30 l/min
Utgang Dusj	ca. 24 l/min
14675XXX / 31675000 /	
31761000 / 33665000:	ca. 32 l/min
Egensikker mot tilbakeflyt:	14477XXX
	31476000
	33457000

Armaturer fra Hansgrohe kan brukes sammen med hydraulisk og termisk strypte gjennomstrømningsovnner når gjennomstrømningstrykket er på minst 0,15 Mpa.

Enhåndblandebatteri med varmtvannsbegrensning. For justering se side8. I forbindelse med en gjennomstrømningsovn er det ikke nødvendig med varmtvannsbegrensning.

I forbindelse med gjennomstrømningsovnner er det ikke tillatt å bygge inn en varmtvannssperre!

Ettersom det kan lekke vann ut av iboxen ved en defekt, skal iboxen monteres over badekaret, slik at vannet som lekker ut kan renne ned i badekaret.

Funksjon til armaturens sikkerhetsinnretninger 14477XXX/31476000/33457000 skal sjekkes en gang i året.

Funksjonen til returløpssperren skal iht. DIN EN 1717 og i samsvar med de nasjonale og lokale forskrifter sjekkes regelmessig (DIN 1988 en gang i året).

Servicelever se side 3

1	Grep Metris E	31094XXX
1.1	Greplugg	96338000
2	Grep Focus E	31791000
3	Grep Metropol E	14094XXX
4	Grep Talis E	33091000
5	Rosett	96453XXX
6	Rosett	96452XXX
7	Kulerosett E	95010XXX
8	Luftventil for rør	96753000
9	Holderkruer (4)	96454000
10	Holderrosett	96447000
11	Mutter	95007000
12	Sikringsskrue	96059000
13	Returløpssperre	96655000
14	Lyddemper	94073000
15	Omstiller kpl.	95014000
16	Kartusj	92730000
17	Kartusj	96448000
18	Trekk-knapp	95013XXX
19	Forlengelse 25 mm	13595000
20	Forlengelse 22 mm	13596000

XXX = Oznake boja

000 hrom
090 hrom/zlatna

Norsk

Prøvermerke

	VDGW	P-IX	SVGW	NF	WRAS	KIWA
14475XXX	X	PA-IX 9709/ICC	X		X	
14477XXX		PA-IX 18097/IDC				
14675XXX	X	PA-IX 9710/IB	X		X	
31475000	X	PA-IX 9709/ICC	X		X	
31476000		PA-IX 18097/IDC				
31675000	X	PA-IX 9710/IB	X			
31744000	X	PA-IX 9709/IDC	X			
31761000	X	PA-IX 9710/IB	X		X	
33455000	X	PA-IX 9709/IDC	X	X	X	X
33457000	X	PA-IX 18097/IDC	X	X		
33655000	X	PA-IX 9710/IB	X	X		X

Feil	Årsak	Feilrettelse
Armatyr ikke lett bevegelig	-Kartusj defekt, forkalkning	-Kartusj byttes
Armatyr drypper	-Kartusj defekt, avleiringer	-Kartusj byttes
Omstiller fungerer ikke	-For lavt vanntrykk -Omstiller defekt	-Øke vanntrykk -Omstiller byttes
For lav varmtvannstemperatur, ikke noe kaldtvann.	-Varmtvannsbegrensning er feil innstilt	-Varmtvannsbegrensning innstilles
Gjennomstrømningssovn slår seg på når det velges kaldt vann.	-Krysstrømning	-Kartusj byttes

Varmtvannsbegrensning: Varmtvannstemperatur 60 C, kaldtvannstemperatur 10 C, gjennomstrømningsstrykk 0,3 bar.

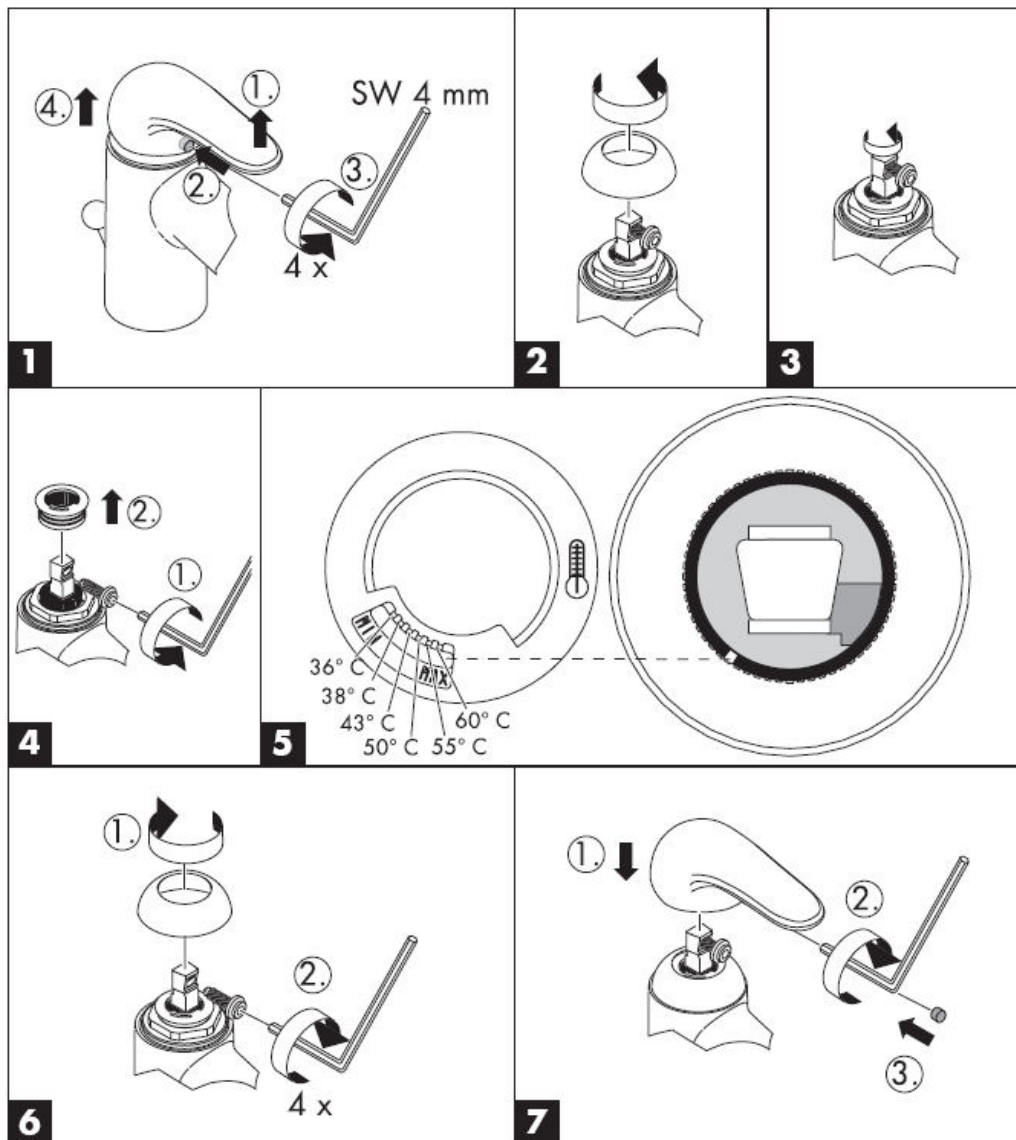

РЪКОВОДСТВО ЗА МОНТАЖ



Metropol E
14475XXX/
14477XXX



Metris E
31475000/
31476000



Focus E
31744000



Talis E
33455000/
33457000



Metropol E
14675XXX



Metris E
31675000



Focus E
31761000



Talis E
33655000

hansgrohe

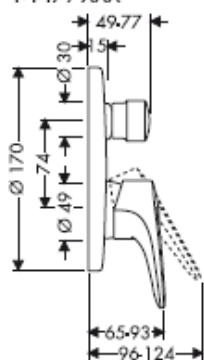
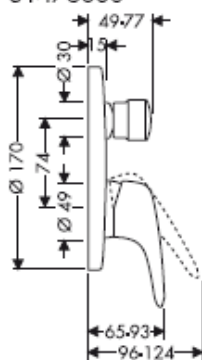
Metropol E14475XXX/
14477XXX**Metris E**31475000/
31476000**Focus E**

31744000

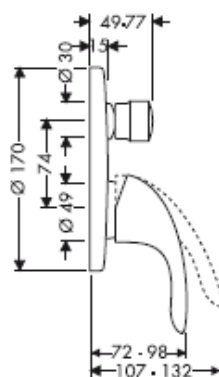
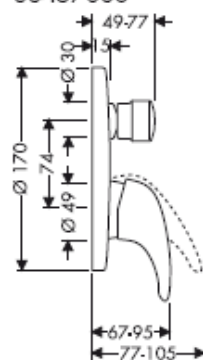
**Talis E**33455000/
33457000**Metropol E**

14675XXX

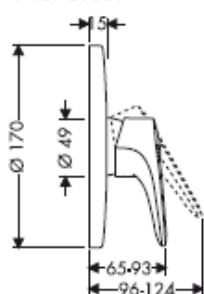
**Metris E**

31675000

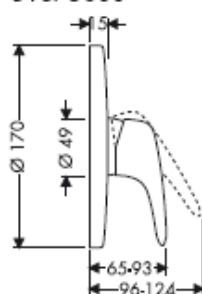
**Focus E**

31761000

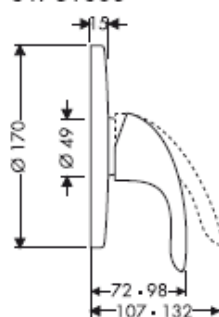
**Talis E**

33655000

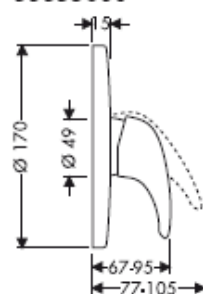

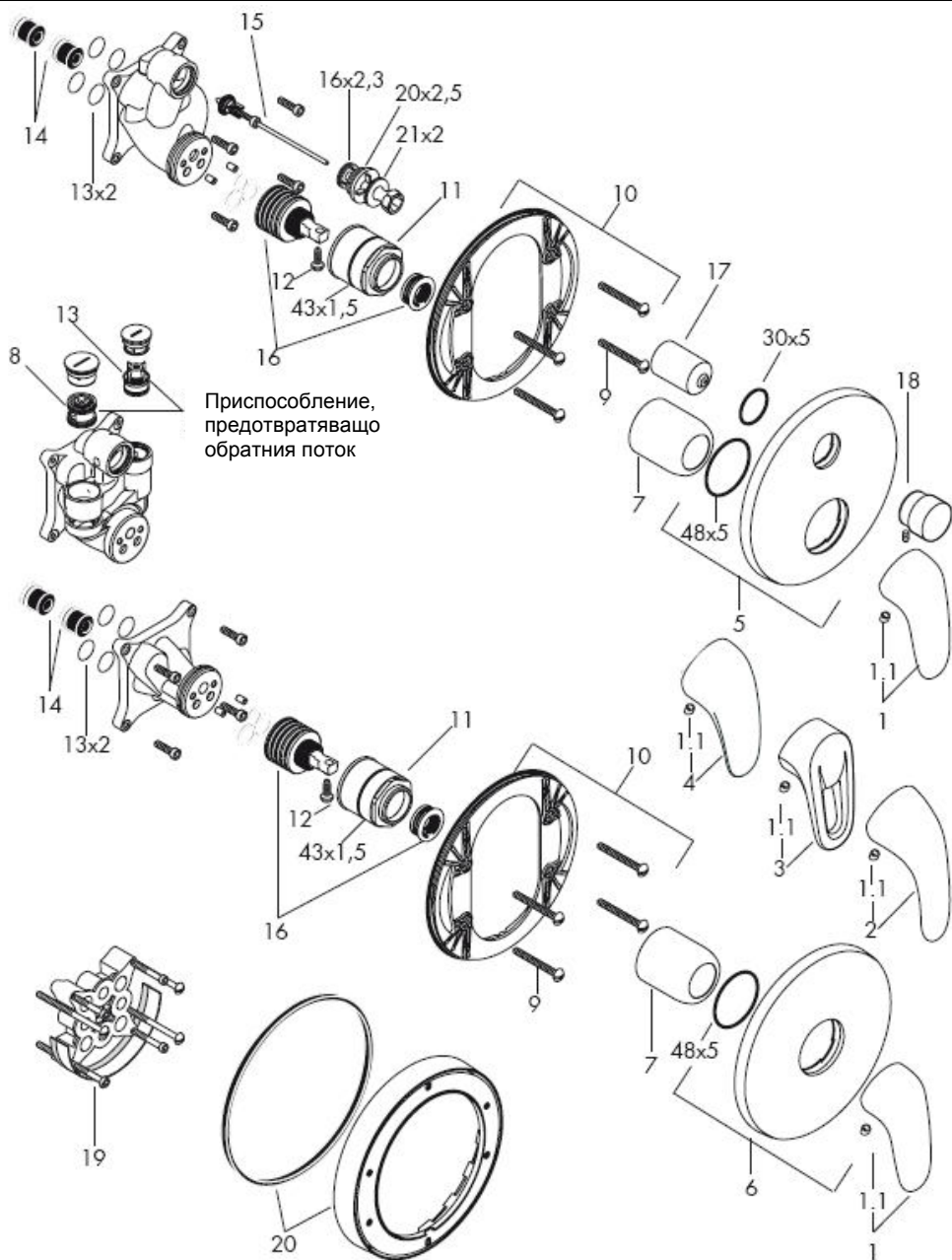

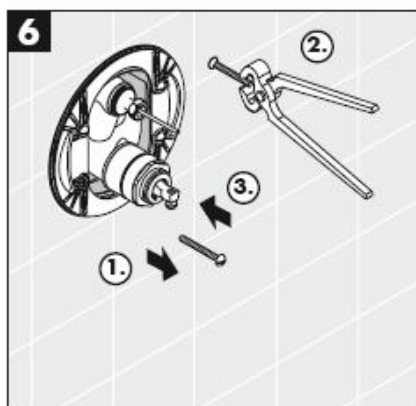
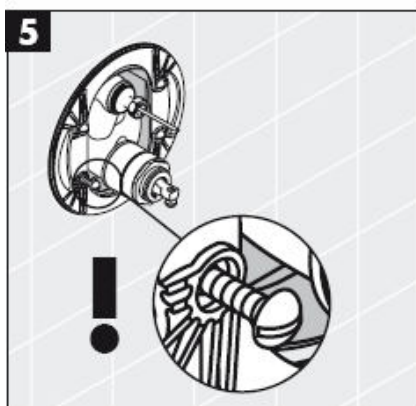
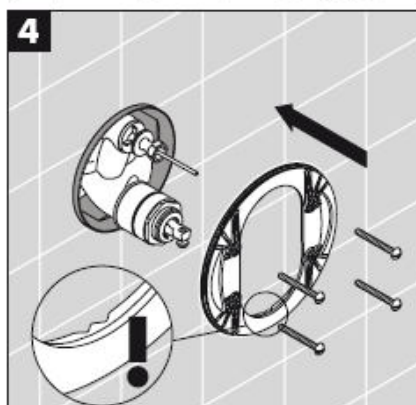
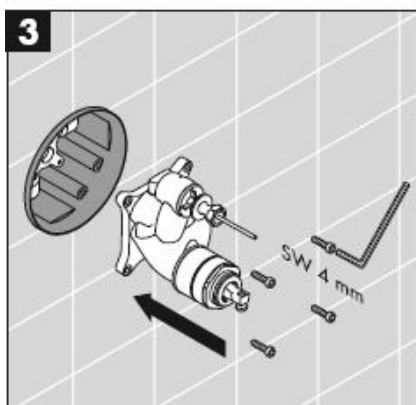
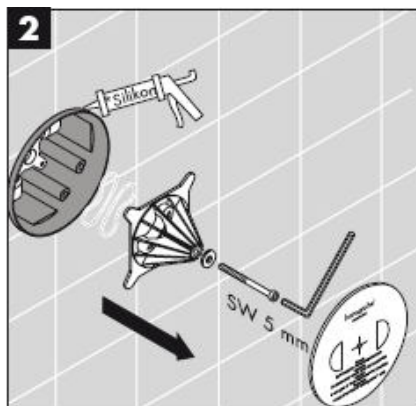
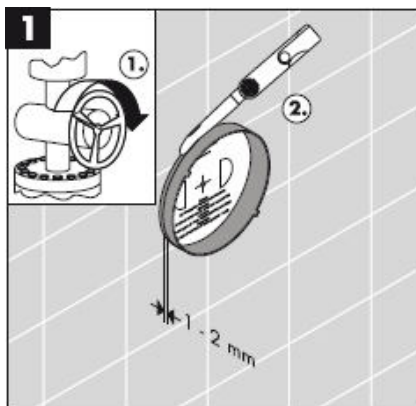

*Силикон (без оцетна киселина!)

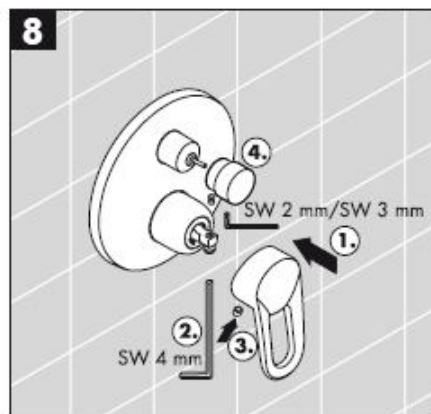
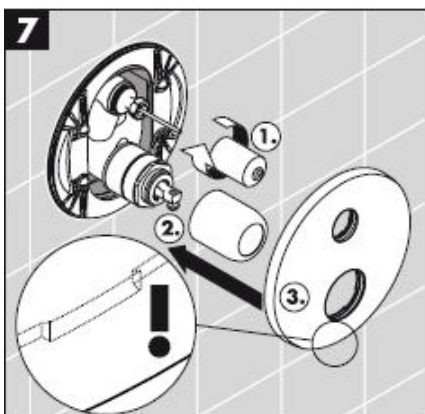

Монтаж

Внимание! Арматурата трябва да се монтира, промие и провери в съответствие с валидните норми!

Обслужване

Смесителят се отваря посредством изтегляне на ръкохватката.

Завъртане наляво = топла вода, надясно = студена вода.

Превключване към ръчен разпръсквател посредством издърпване на копчето за превключване. Връщането обратно се извършва автоматично след затваряне на ръкохватката.

Технически данни

Работно налягане: max. 1 MPa

Препоръчително работно налягане: 0,1 – 0,5 MPa

Контролно налягане: 1,6 MPa
(1 MPa = 10 bar = 147 PSI)

Температура на горещата вода: max. 80° C
Препоръчителна температура на горещата вода: 65° C

Мощност на потока: 0,3 MPa

14475XXX / 14477XXX /

31475000 / 31476000 /

31744000 / 33455000 / 33457000:

Извод Вана ca. 30 l/min

Извод Разпръсквател ca. 24 l/min

14675XXX / 31675000 /

31761000 / 33665000: ca. 32 l/min

Самозащитен против обратно изтичане:

14477XXX

31476000

33457000

Смесителите с една ръкохватка на Hansgrohe могат да се използват във връзка с хидравлично и термично управляеми проточни нагреватели, ако хидравличното налягане е минимум 0,15 MPa.

Смесител с една ръкохватка с ограничител за топлата вода, юстирането вижте на стр. 8. Във връзка с проточни нагреватели не е необходима блокировка за топлата вода.

	4	Ръкохватка Talis F	33091000
	5	Розетка	96453XXX
	6	Розетка	96452XXX
Тъй като при дефект на функционалните части около iBox може да изтече вода, iBox трябва да се монтира над ваната, за да може изтичащата вода да се отича във ваната!	7	Сферична розетка E	95010XXX
	8	Тръбна вентилационна система	96753000
	9	Носещи болтове (4)	96454000
	10	Носеща розетка	96447000
Веднъж годишно трябва да се проверява функцията на предпазните приспособления на арматури 14477XXX/31476000/33457000	11	Гайка	95007000
	12	Предпазен болт	96059000
	13	Приспособление, предотвратяващо обратния поток	96655000
	14	Заглушител	94073000
Съгласно DIN EN 1717 редовно трябва да се проверява функционирането на приспособленията за предотвратяване на обратния поток в съответствие с националните или регионални изисквания (DIN 1988 веднъж годишно).	15	Превключватели компл.	95014000
	16	Гилзи компл.	92730000
	17	Втулка на превключвателя	96448000
	18	Втулка на превключвателя	95013XXX
	19	Удължител 25 mm	13595000
	20	Удължител 22 mm	13596000

Сервизни части вижте стр. 3

1	Ръкохватка Metris E	31094XXX
1.1	Пробка на ръкохватката	96338000
2	Ръкохватка Focus E	31791000
3	Ръкохватка Metropol E	14094XXX

XXX = Oznake boja

000 hrom
090 hrom/zlatna

БЪЛГАРСКИ

Контролен знак

	DVGW	P-IX	SVGW	NF	WRAS	KIWA
14475XXX	X	PA-IX 9709/ICC	X		X	
14477XXX		PA-IX 18097/IDC				
14675XXX	X	PA-IX 9710/IB	X		X	
31475000	X	PA-IX 9709/ICC	X		X	
31476000		PA-IX 18097/IDC				
31675000	X	PA-IX 9710/IB	X			
31744000	X	PA-IX 9709/IDC	X			
31761000	X	PA-IX 9710/IB	X		X	
33455000	X	PA-IX 9709/IDC	X	X	X	X
33457000	X	PA-IX 18097/IDC	X	X		
33655000	X	PA-IX 9710/IB	X	X		X

Неизправност

Причина

Помощ

Трудно подвижна арматура	-Дефектна гилза, покрита с варовик	-Сменете гилзата
Арматурата капе	-Дефектна гилза, отлагания	-Сменете гилзата
Превключвателят не функционира	-Твърде малко налягане на водата -Дефектен превключвател	-Повишаване на налягането на водата -Сменете превключвателя
Твърде ниска температура на топлата вода, няма студена вода. Проточният нагревател се задейства, когато се избере студена вода	-Ограничението за топлата вода е грушно настроено -Кръстосване на потока	-Настройте ограничението за топлата вода -Сменете гилзата

Ограничител за топлата вода: Температура на топлата вода 60 C, Температура на студената вода 10 C, хидравлично налягане 0,3 МПа.

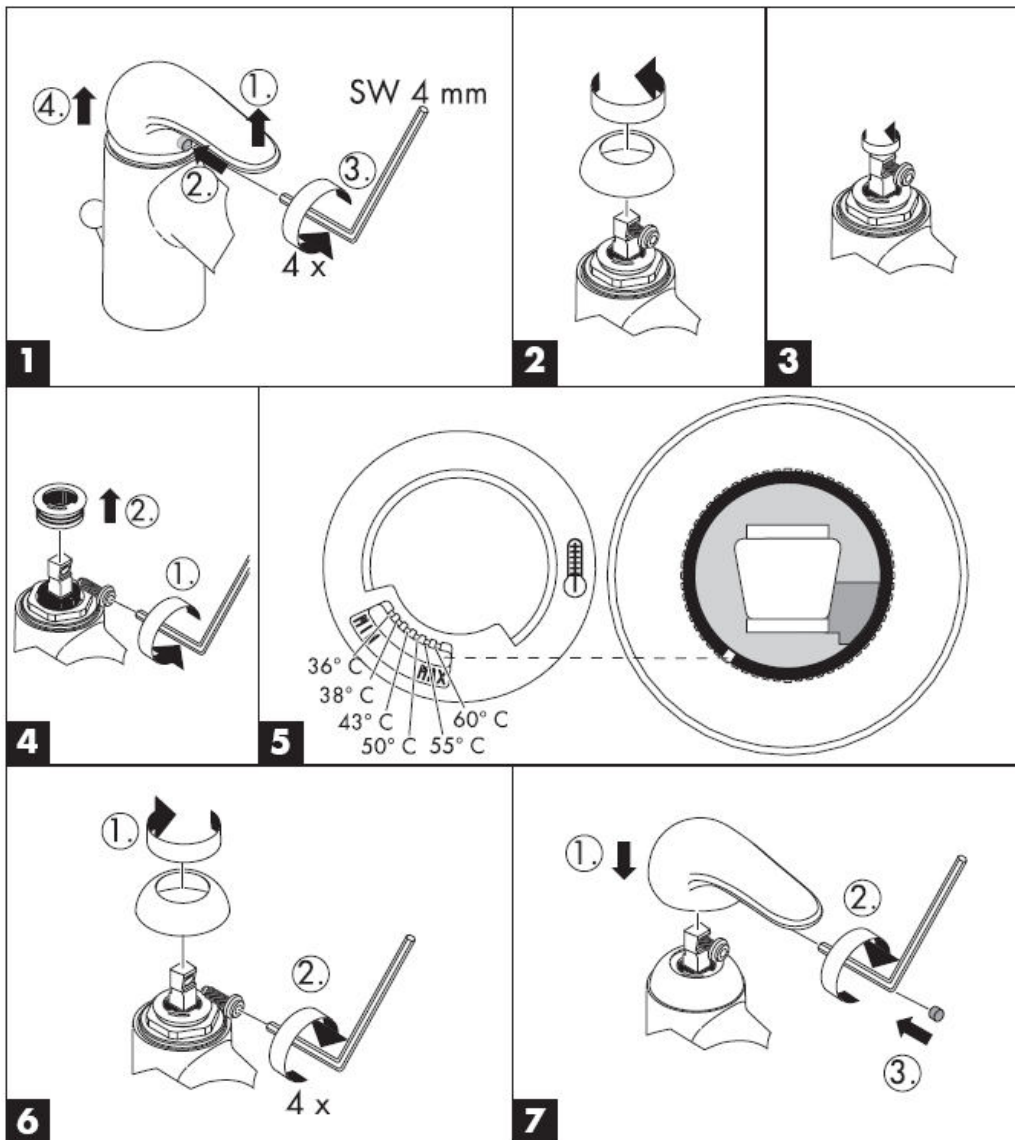

Udhëzime rreth montimit



Metropol E
14475XXX/
14477XXX



Metris E
31475000/
31476000



Focus E
31744000



Talis E
33455000/
33457000



Metropol E
14675XXX



Metris E
31675000



Focus E
31761000



Talis E
33655000

hansgrohe

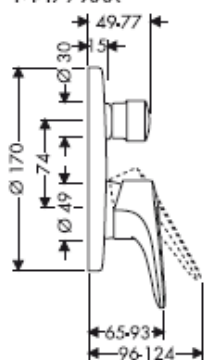
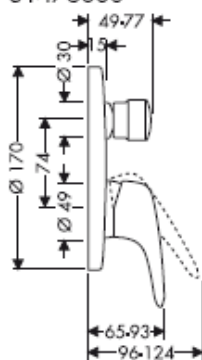
Metropol E14475XXX/
14477XXX**Metris E**31475000/
31476000**Focus E**

31744000

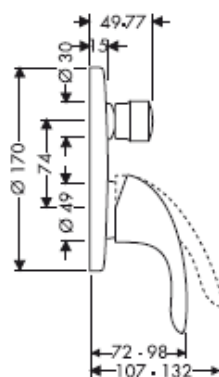
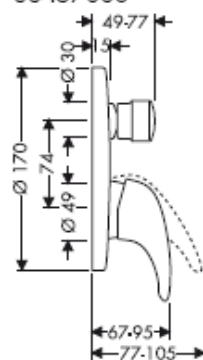
**Talis E**33455000/
33457000**Metropol E**

14675XXX

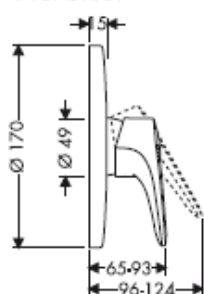
**Metris E**

31675000

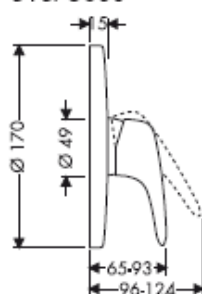
**Focus E**

31761000

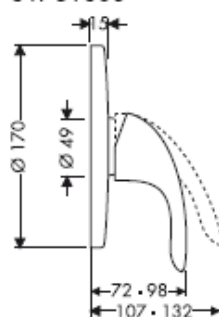
**Talis E**

33655000

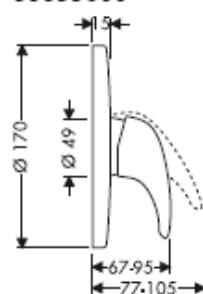

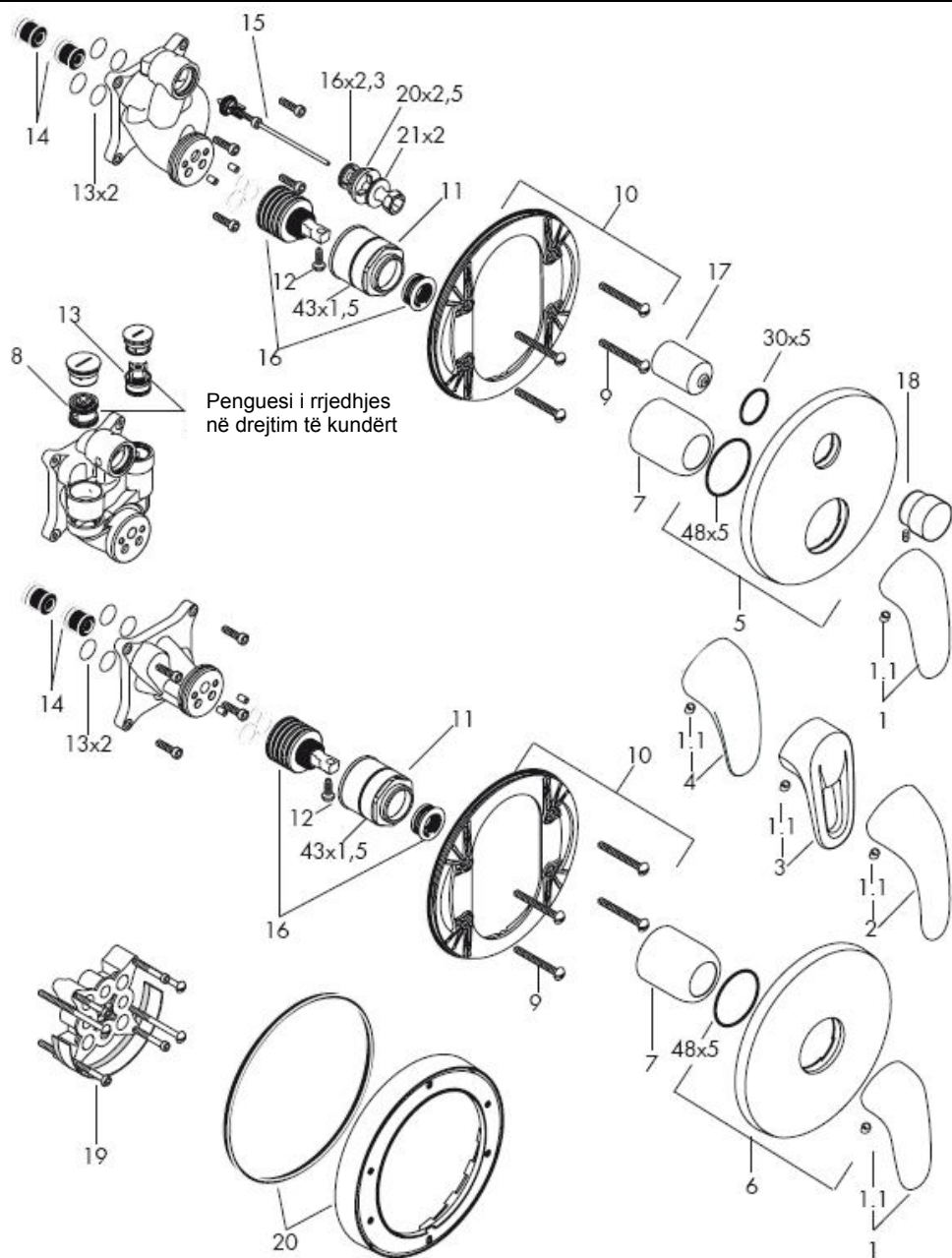

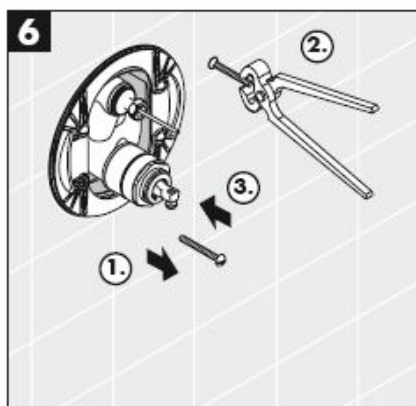
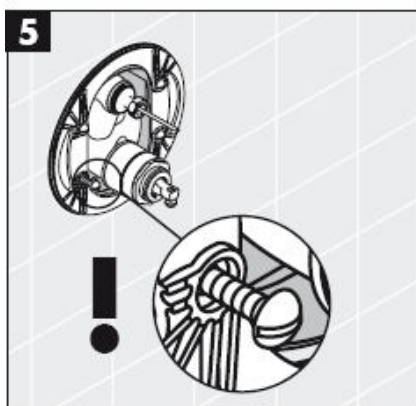
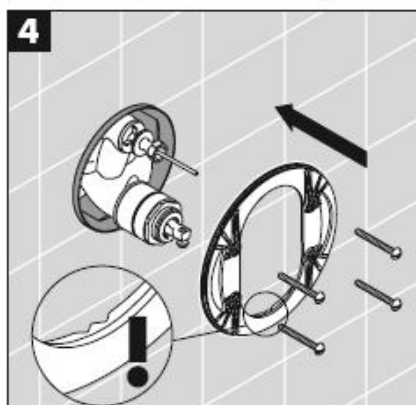
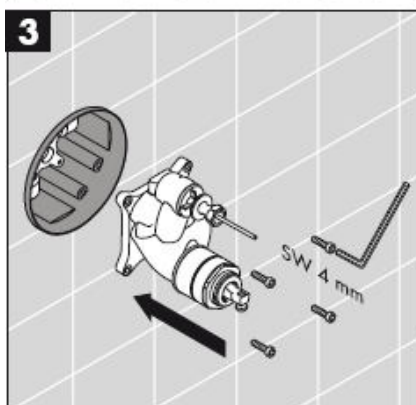
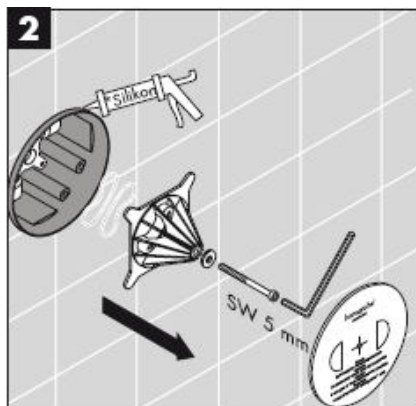
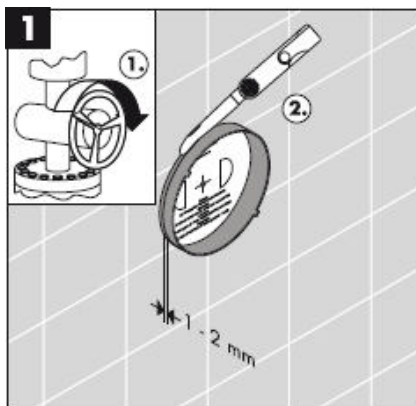

*Silikon (pa acid uthulle!)

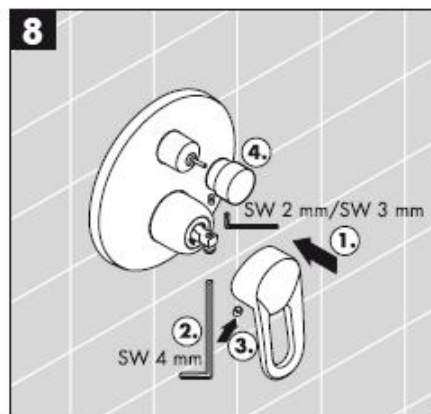
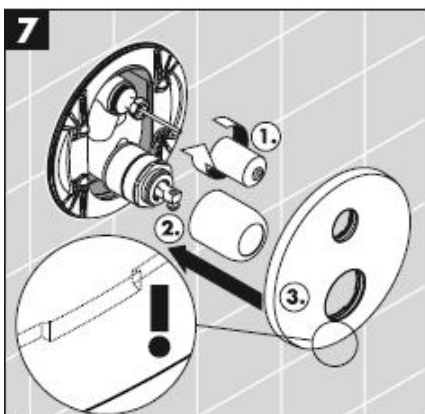

Montimi

Kujdes! Armatura duhet montuar, shpërlarë dhe kontrolluar në bazë të normave të vlefshme!

Përdorimi

Rubineti me ujë të përzier hapet duke tërhequr dorezën.

Rrotullimi i dorezës në të majtë = ujë i ngrohtë, në të djathtë = ujë i ftohtë.

Ndërrimi i pozicionit në atë të spërkatëses së dorës përmes tërheqjes së butonit përkatës.

Kthimi në pozicionin e mëparshëm bëhet automatikisht pas mbylljes së dorezës.

Të dhëna teknike

Presioni gjatë punës max. 1 MPa
 Presioni i rekomanduar: 0,1 – 0,5 MPa
 Presioni për provë: 1,6 MPa
 (1 MPa = 10 bar = 147 PSI)

Temperatura e ujit të ngrohtë max. 80° C
 Temperatura e rekomanduar e ujit të ngrohtë: 65° C

Kapaciteti i rrjedhjes: 0,3 MPa

14475XXX / 14477XXX /

31475000 / 31476000 /

31744000 / 33455000 / 33457000:

Zbrazja Vaska ca. 30 l/min

Zbrazja Spërkatëse ca. 24 l/min

14675XXX / 31675000 /

31761000 / 33665000: ca. 32 l/min

Siguresa kundër rrjedhjes në drejtim të kundërt:

14477XXX

31476000

33457000

Armaturat me ujë të përzier të Hansgrohe mund të përdoren në kombinim me ngrohës elektrikë të ujit të drejtuar në mënyrë hidraulike ose termike nëse presioni i rrjedhjes është minimumi 0,15 MPa.

Rubinet me ujë të përzier me kufizim të ujit të ngrohtë, justimi shih faqen 8.

Në kombinim me ngrohësit elektrikë të ujit nuk ka nevojë për bllokadë të ujit të ngrohtë.

Në kombinim me ngrohës elektrikë të ujit nuk duhen montuar bllokada të ujit të ngrohtë!

Meqë në rast të ndonjë defekti të pjesëve funksionale mund të rrjedhë ujë nga ibox-i, është e nevojshme që ibox-i të montohet sipër vaskës, me qëllim që uji që rrjedh të derdhet në vaskë!

Njësitë për siguri të armaturave
 14477XXX/31476000/33457000 duhen kontrolluar një herë në vit.

Penguesit e rrjedhjes në drejtim të kundërt duhen kontrolluar rregullisht në bazë të normave DIN EN 1717 konform normave nacionale dhe regjionale (DIN 1988 një herë në vit).

Pjesët e servisit shih faqen _1c 3

1	Dorezë Metris E	31094XXX
1.1	Tapë për dorezën	96338000
2	Dorezë Focus E	31791000
3	Dorezë Metropol E	14094XXX
4	Dorezë Talis E	33091000
5	Rozeta	96453XXX
6	Rozeta	96452XXX
7	Rozetë sferike E	95010XXX
8	Ajrosësi i tubave	96753000
9	Vidhat e mbajtëses (4)	96454000
10	Rozeta e mbajtëses	96447000
11	Dado	95007000
12	Vidha sigurimi	96059000
13	Penguesi i rrjedhjes në drejtim të kundërt	96655000
14	Silenciator	94073000
15	Ndërruesi komplet	95014000
16	Kaseta komplet	92730000
17	Gëzhoja e ndërruesit	96448000
18	Butoni tërheqës	95013XXX
19	Butoni tërheqës 25 mm	13595000
20	Butoni tërheqës 22 mm	13596000

XXX = Oznake boja

000 hrom

090 hrom/zlatna

Shqib

Shenja e kontrollit

	DVGW	P-IX	SVGW	NF	WRAS	KIWA
14475XXX	X	PA-IX 9709/ICC	X		X	
14477XXX		PA-IX 18097/IDC				
14675XXX	X	PA-IX 9710/IB	X		X	
31475000	X	PA-IX 9709/ICC	X		X	
31476000		PA-IX 18097/IDC				
31675000	X	PA-IX 9710/IB	X			
31744000	X	PA-IX 9709/IDC	X			
31761000	X	PA-IX 9710/IB	X		X	
33455000	X	PA-IX 9709/IDC	X	X	X	X
33457000	X	PA-IX 18097/IDC	X	X		
33655000	X	PA-IX 9710/IB	X	X		X

Dentim

Shkaku

Ndihme

Armatura punon rende

-Kartusha me defekt, me kalk

-Kembeni kartushen

Armatura pikon

-Kartusha me defekt, depozitime

-Kembeni kartushen

Kalibruesi nuk funksionon

-Presion shumë i ulët i ujit
-Kalibruesi me defekt

-Rrisni presionin e ujit
-kembeni kalibruesin

Temperaturë e ulët e ujit të ngrohtë, nuk ka ujë të ftohtë. Ngrohësi elektrik i ujit ndizet kur zgjidhet uji i ftohtë.

-Kufiri i ujit të ngrohtë është regjistruar gabim
-Rrjedhje e kryqëzuar.

-Regjistroni kufirin e ujit të ngrohtë
-Kembeni kartushen

Kufizimi i ujit të ngrohtë: Temperatura e ujit të ngrohtë 60 C, temperatura e ujit të ftohtë 10 C, presioni i rrjedhjes 0,3 MPa.

