

# Montageanleitung

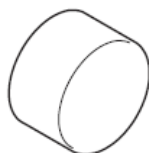

**Steel Fixfit**  
35884800

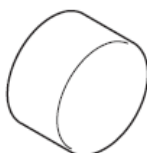

**Steel Fixfit Deluxe**  
35888800  
**Starck Fixfit Deluxe**  
27451XXX



**Montreux  
Fixfit Deluxe**  
16884XXX

Eigensicher gegen Rückfließen

# AXOR<sup>®</sup>

**hansgrohe**

**Starck 27451XXX**  
**Steel 35884800/35888800**

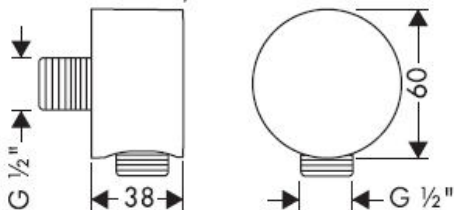

**Montreux 16884XXX**

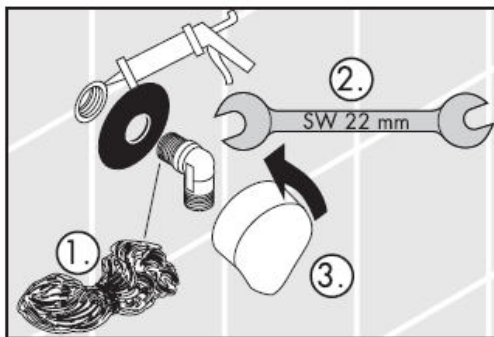
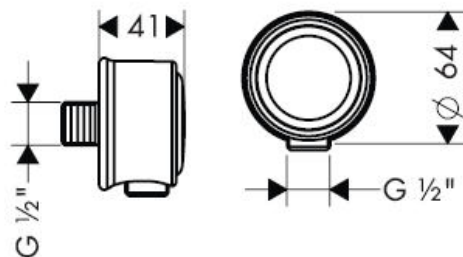

**Fixfit Deluxe 27451XXX/35888800/16884XXX**

DVGW Reg.-Nr.: DW-6511AT2271



**Achtung!** Die Rückflussverhinderer müssen gemäß DIN 1988 einmal jährlich auf ihre Funktion geprüft werden.

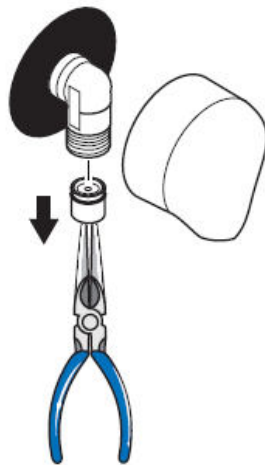

**hansgrohe**

# Instructions de montage

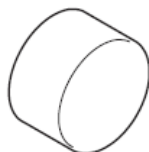

**Steel Fixfit**  
35884800

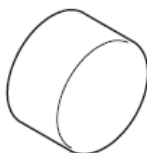

**Steel Fixfit Deluxe**  
35888800  
**Starck Fixfit Deluxe**  
27451XXX



**Montreux  
Fixfit Deluxe**  
16884XXX

Avec dispositif anti-retour

# AXOR<sup>®</sup>

**hansgrohe**

**Starck 27451XXX**  
**Steel 35884800/35888800**

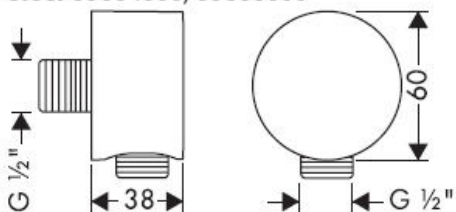

**Montreux 16884XXX**

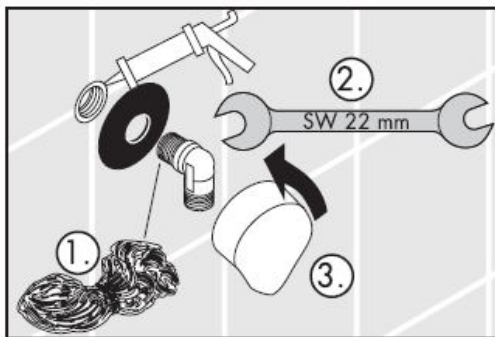
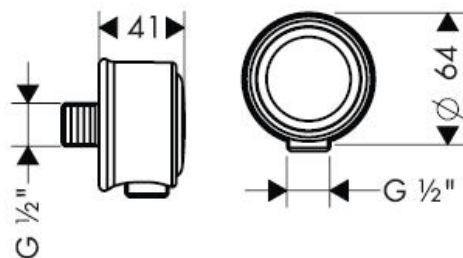

**Fixfit Deluxe 27451XXX/35888800/16884XXX**

DVGW Reg.-Nr.: DW-6511AT2271



**Attention!** Les clapets anti-retour doivent être vérifié une fois par an.

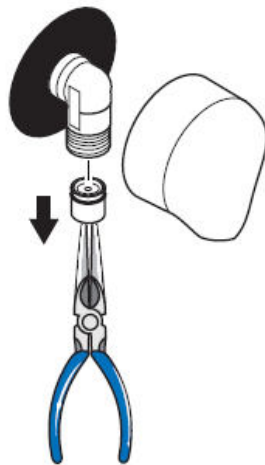

**hansgrohe**

# assembly instructions



**Steel Fixfit**  
35884800

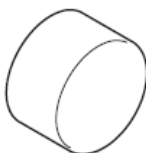

**Steel Fixfit Deluxe**  
35888800  
**Starck Fixfit Deluxe**  
27451XXX



**Montreux  
Fixfit Deluxe**  
16884XXX

anti-pollution function

# AXOR<sup>®</sup>

**hansgrohe**

**Starck 27451XXX**  
**Steel 35884800/35888800**

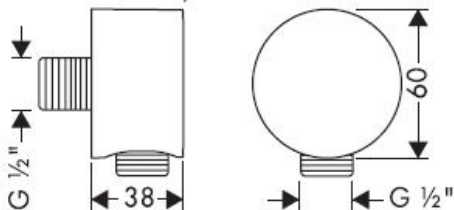

**Montreux 16884XXX**

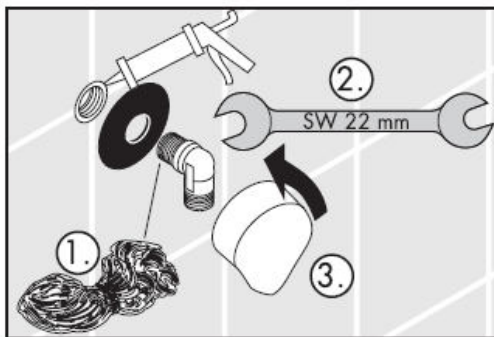
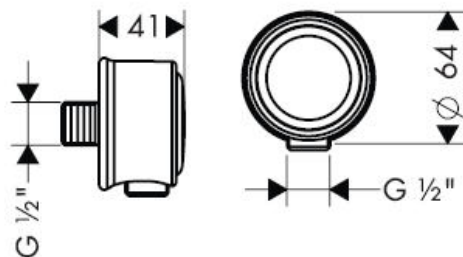

**Fixfit Deluxe 27451XXX/35888800/16884XXX**

DVGW Reg.-Nr.: DW-6511AT2271



**Important!** The non return valves must be checked once a year.

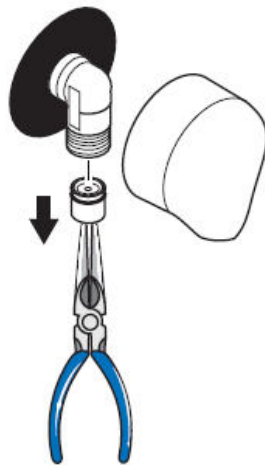

**hansgrohe**

# Istruzioni per Installazione

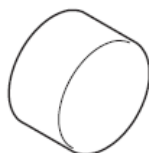

**Steel Fixfit**  
35884800

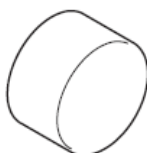

**Steel Fixfit Deluxe**  
35888800  
**Starck Fixfit Deluxe**  
27451XXX



**Montreux  
Fixfit Deluxe**  
16884XXX

Sicurezza antiriflusso

**AXOR**<sup>®</sup>

**hansgrohe**

**Starck 27451XXX**  
**Steel 35884800/35888800**

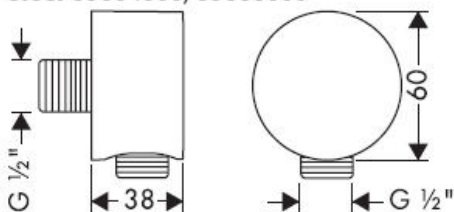

**Montreux 16884XXX**

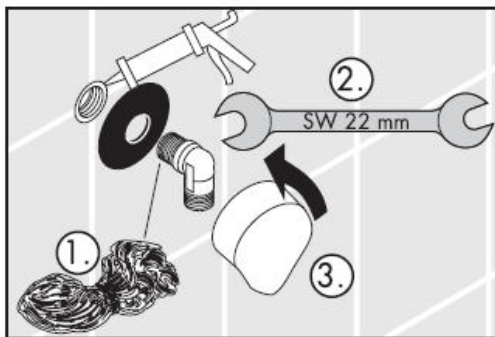
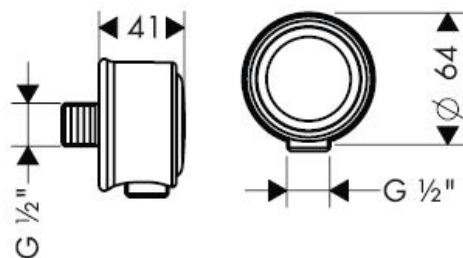

**Fixfit Deluxe 27451XXX/35888800/16884XXX**

DVGW Reg.-Nr.: DW-6511AT2271



**Attenzione!** La valvola di non ritorno deve essere controllata una volta all'anno.

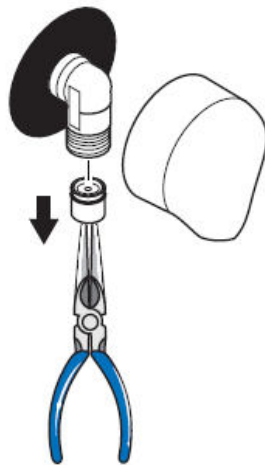

**hansgrohe**



# Instrucciones de montaje

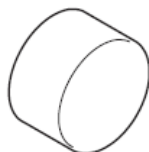

**Steel Fixfit**  
35884800



**Steel Fixfit Deluxe**  
35888800  
**Starck Fixfit Deluxe**  
27451XXX



**Montreux  
Fixfit Deluxe**  
16884XXX

Seguro contra el retorno

**AXOR**<sup>®</sup>

**hansgrohe**

**Starck 27451XXX**  
**Steel 35884800/35888800**

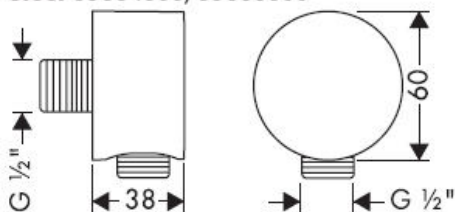

**Montreux 16884XXX**

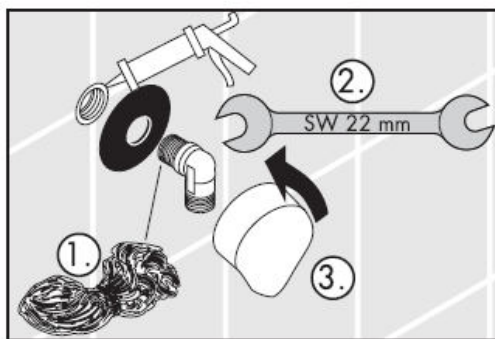
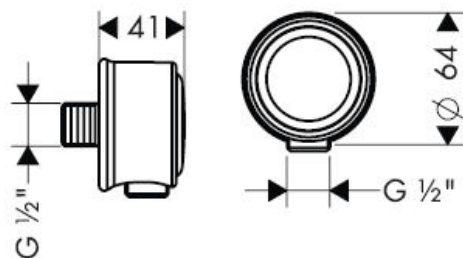

**Fixfit Deluxe 27451XXX/35888800/16884XXX**

DVGW Reg.-Nr.: DW-6511AT2271



**¡Atención!** Las válvulas anti-retorno se han de revisar una vez al año.

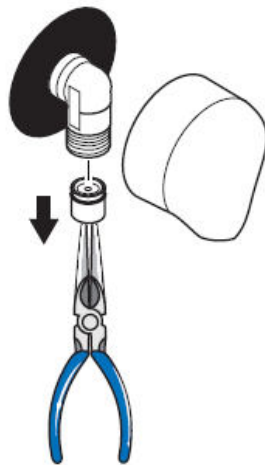

**hansgrohe**

# Handleiding

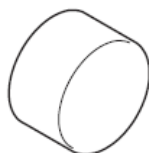

**Steel Fixfit**  
35884800



**Steel Fixfit Deluxe**  
35888800  
**Starck Fixfit Deluxe**  
27451XXX



**Montreux  
Fixfit Deluxe**  
16884XXX

Beveiligd tegen terugstromen

# AXOR<sup>®</sup>

**hansgrohe**

**Starck 27451XXX**  
**Steel 35884800/35888800**

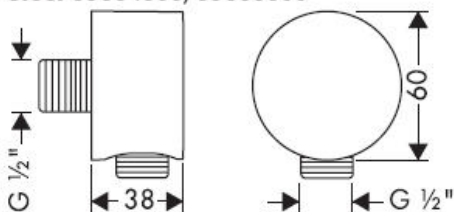

**Montreux 16884XXX**

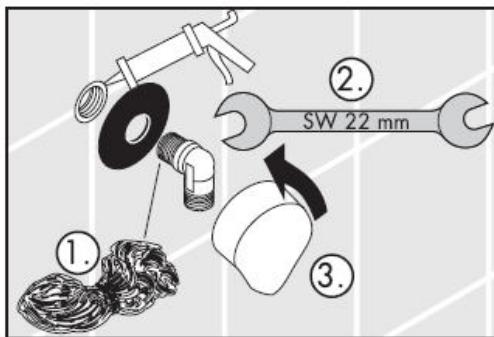
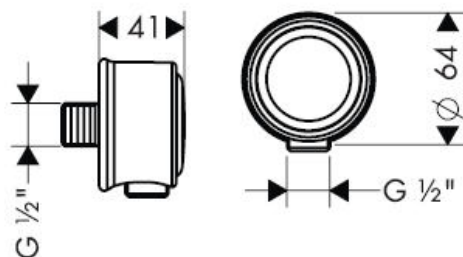

**Fixfit Deluxe 27451XXX/35888800/16884XXX**

DVGW Reg.-Nr.: DW-6511AT2271



**Attentie!** Het functioneren van de terugslagklep-pen moet jaarlijks worden getest.

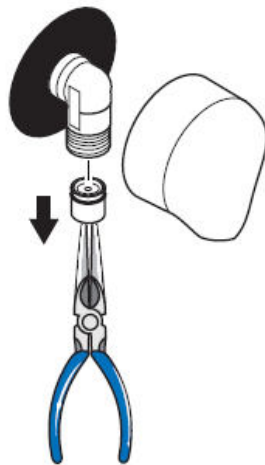

**hansgrohe**

# Monteringsvejledning



**Steel Fixfit**  
35884800

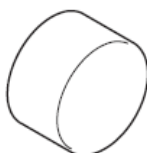

**Steel Fixfit Deluxe**  
35888800  
**Starck Fixfit Deluxe**  
27451XXX



**Montreux  
Fixfit Deluxe**  
16884XXX

Med indbygget kontraventil

# AXOR<sup>®</sup>

hansgrohe

**Starck 27451XXX**  
**Steel 35884800/35888800**

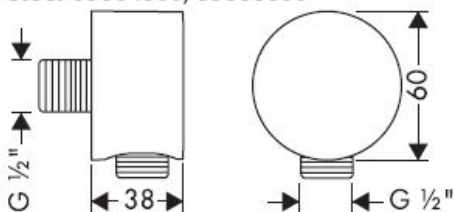

**Montreux 16884XXX**

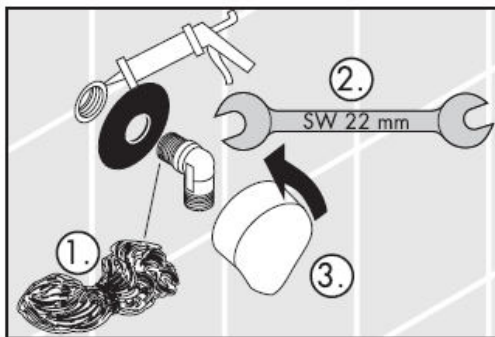
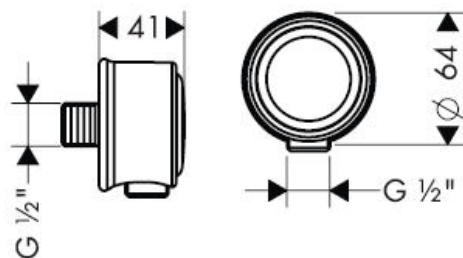

**Fixfit Deluxe 27451XXX/35888800/16884XXX**

DVGW Reg.-Nr.: DW-6511AT2271



**Advarsel!** Kontraventilen skal afprøves en gang om året.

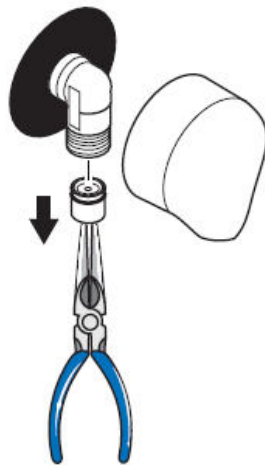

**hansgrohe**

# Manual de Instalação

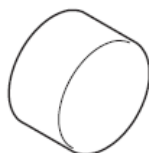

**Steel Fixfit**  
35884800

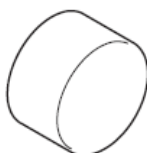

**Steel Fixfit Deluxe**  
35888800  
**Starck Fixfit Deluxe**  
27451XXX



**Montreux  
Fixfit Deluxe**  
16884XXX

Função anti-retorno e anti-vácuo

# AXOR<sup>®</sup>

**hansgrohe**

**Starck 27451XXX**  
**Steel 35884800/35888800**

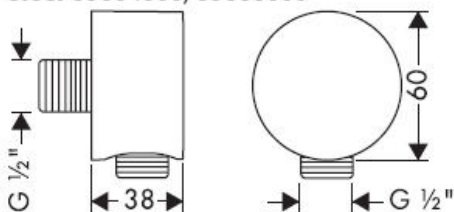

**Montreux 16884XXX**

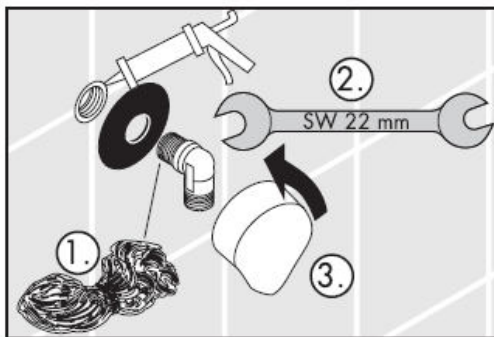
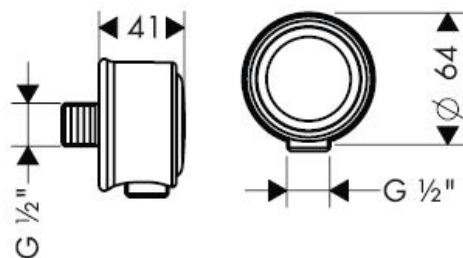

**Fixfit Deluxe 27451XXX/35888800/16884XXX**

DVGW Reg.-Nr.: DW-6511AT2271



**Atenção!** As válvulas anti-retorno têm que ser verificadas uma vez por ano.

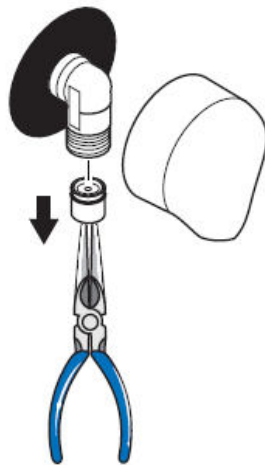

**hansgrohe**



# Instrukcja montażu

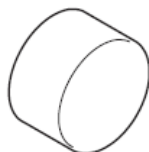

**Steel Fixfit**  
35884800



**Steel Fixfit Deluxe**  
35888800  
**Starck Fixfit Deluxe**  
27451XXX



**Montreux  
Fixfit Deluxe**  
16884XXX

Samoistnie zabezpieczony przed  
przepływem zwrrotnym

# AXOR<sup>®</sup>

**hansgrohe**

**Starck 27451XXX**  
**Steel 35884800/35888800**

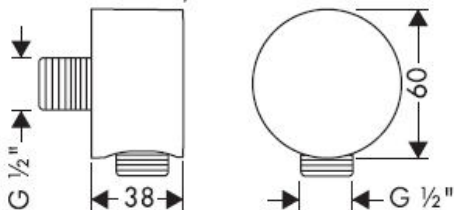

**Montreux 16884XXX**

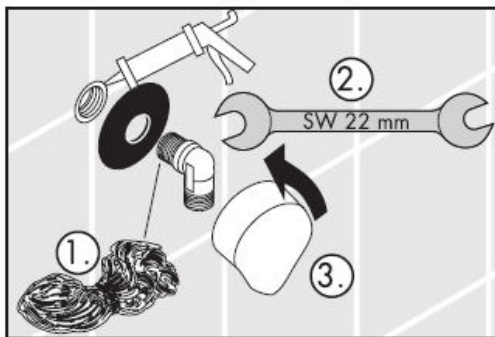
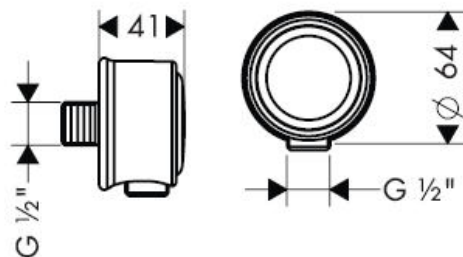

**Fixfit Deluxe 27451XXX/35888800/16884XXX**

DVGW Reg.-Nr.: DW-6511AT2271



**Uwaga!** Zgodnie z normą DIN 1988 działanie zabezpieczeń przepływu zwrotnego należy skontrolować raz w roku.

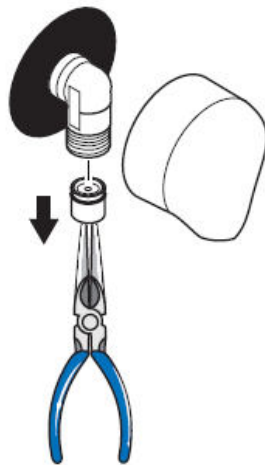

**hansgrohe**

# Montážní návod

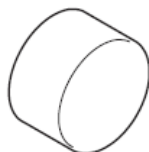

**Steel Fixfit**  
35884800

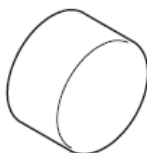

**Steel Fixfit Deluxe**  
35888800  
**Starck Fixfit Deluxe**  
27451XXX



**Montreux  
Fixfit Deluxe**  
16884XXX

Vlastní jištění proti zpětnému nasátí.

**AXOR**<sup>®</sup>

**hansgrohe**

**Starck 27451XXX**  
**Steel 35884800/35888800**

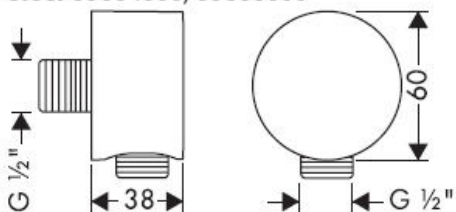

**Montreux 16884XXX**

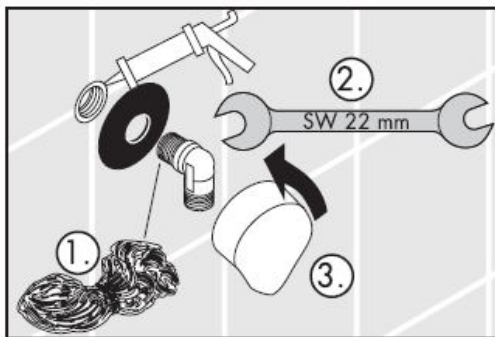
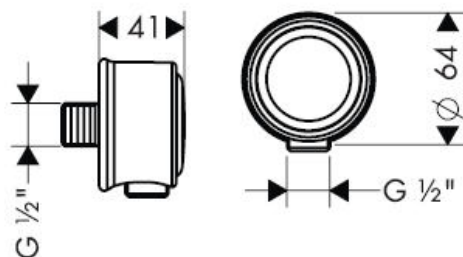

**Fixfit Deluxe 27451XXX/35888800/16884XXX**

DVGW Reg.-Nr.: DW-6511AT2271



**Pozor!** U jistění proti zpětnému nasátí musí být podle normy DIN 1988 jednou ročně přezkoušena jeho funkce.

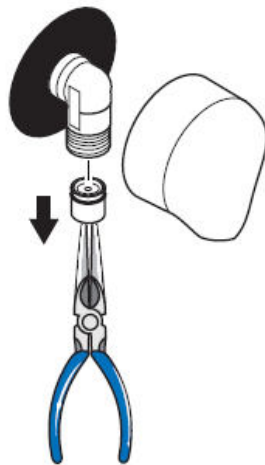

**hansgrohe**

# Montážny návod



**Steel Fixfit**  
35884800



**Steel Fixfit Deluxe**  
35888800  
**Starck Fixfit Deluxe**  
27451XXX



**Montreux  
Fixfit Deluxe**  
16884XXX

Vlastná poistka proti spätnému nasatiu.

**AXOR**<sup>®</sup>

**hansgrohe**

**Starck 27451XXX**  
**Steel 35884800/35888800**

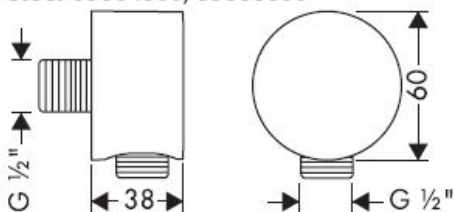

**Montreux 16884XXX**

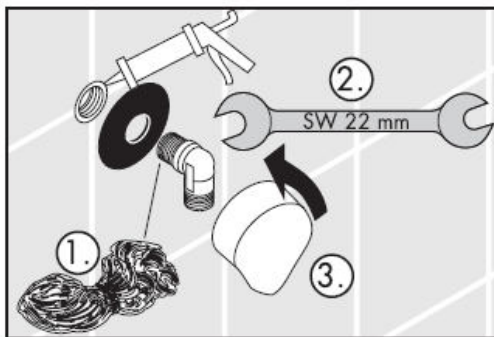
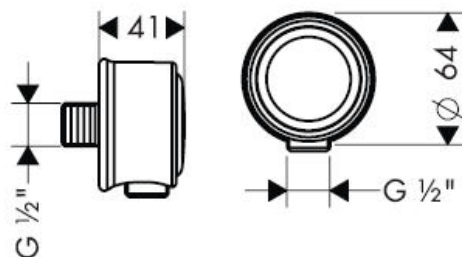

**Fixfit Deluxe 27451XXX/35888800/16884XXX**

DVGW Reg.-Nr.: DW-6511AT2271



**Pozor!** Pri poistke proti spätnému nasatiu musí byť podľa normy DIN 1988 raz ročne preskúšaná jej funkčnosť.

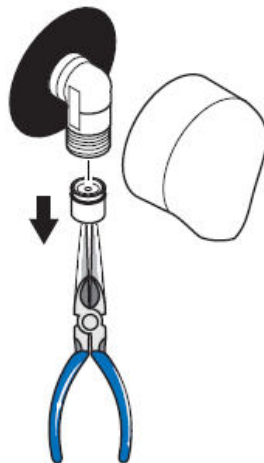

**hansgrohe**

# 组装说明

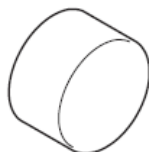

**Steel Fixfit**  
35884800



**Steel Fixfit Deluxe**  
35888800  
**Starck Fixfit Deluxe**  
27451XXX



**Montreux  
Fixfit Deluxe**  
16884XXX

自动防止回流

# AXOR<sup>®</sup>

hansgrohe

**Starck 27451XXX**  
**Steel 35884800/35888800**

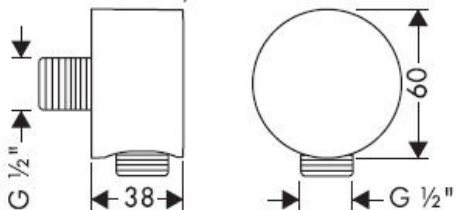

**Montreux 16884XXX**

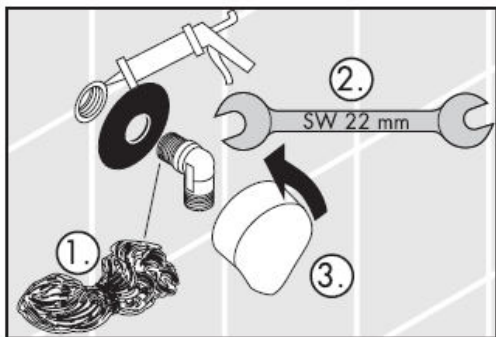
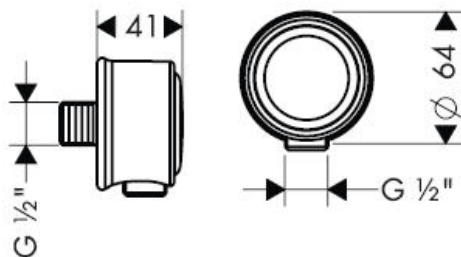

**Fixfit Deluxe 27451XXX/35888800/16884XXX**

DVGW Reg.-Nr.: DW-6511AT2271



**注意！** 每年必须按照DIN 1988对单向阀的功能进行一次检查。

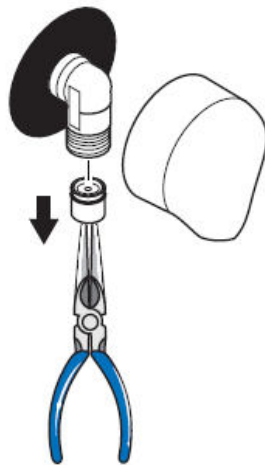

**hansgrohe**



# Инструкция по монтажу



**Steel Fixfit**  
35884800



**Steel Fixfit Deluxe**  
35888800  
**Starck Fixfit Deluxe**  
27451XXX



**Montreux  
Fixfit Deluxe**  
16884XXX

укомплектован клапаном обратного тока  
воды

# AXOR<sup>®</sup>

**hansgrohe**

**Starck 27451XXX**  
**Steel 35884800/35888800**

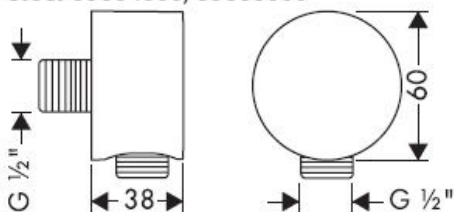

**Montreux 16884XXX**

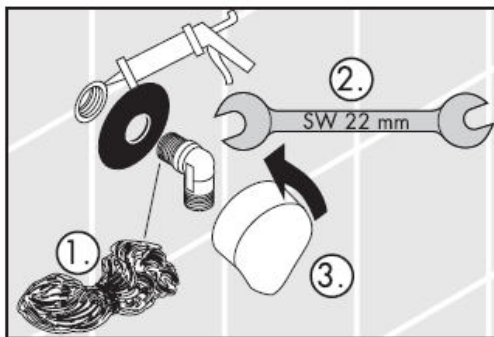
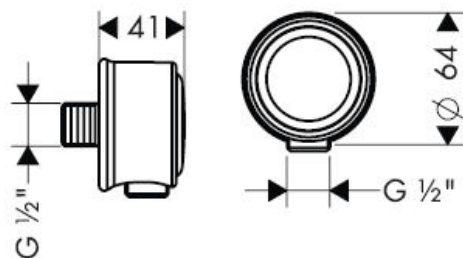

**Fixfit Deluxe 27451XXX/35888800/16884XXX**

DVGW Reg.-Nr.: DW-6511AT2271



**ВНИМАНИЕ!** клапан обратного тока воды должен проверяться  
не реже одного раза в год

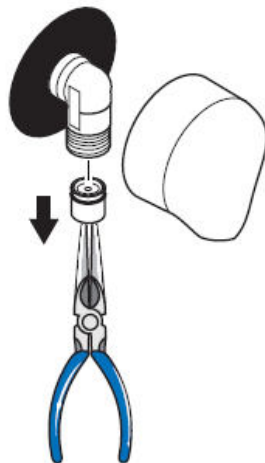

**hansgrohe**

# Szerelési útmutató



**Steel Fixfit**  
35884800

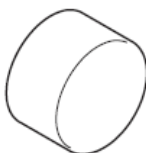

**Steel Fixfit Deluxe**  
35888800  
**Starck Fixfit Deluxe**  
27451XXX



**Montreux  
Fixfit Deluxe**  
16884XXX

Visszafolyás gátlóval

# AXOR<sup>®</sup>

**hansgrohe**

**Starck 27451XXX**  
**Steel 35884800/35888800**

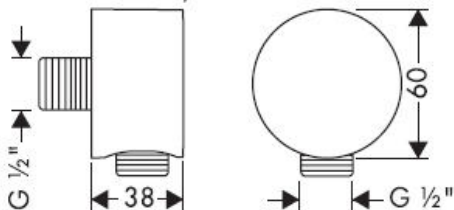

**Montreux 16884XXX**

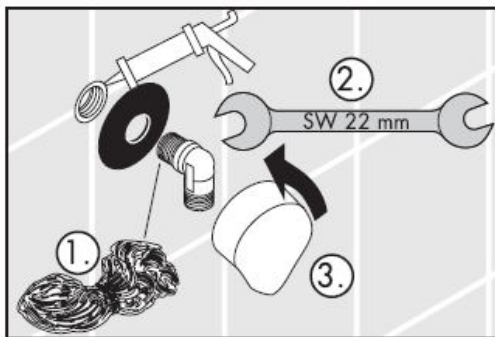
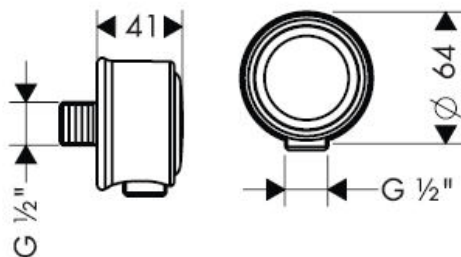

**Fixfit Deluxe 27451XXX/35888800/16884XXX**

DVGW Reg.-Nr.: DW-6511AT2271



**Figyelem!** A visszafolyásgátlók működését a DIN 1988 szerint évente egyszer ellenőrizni kell.

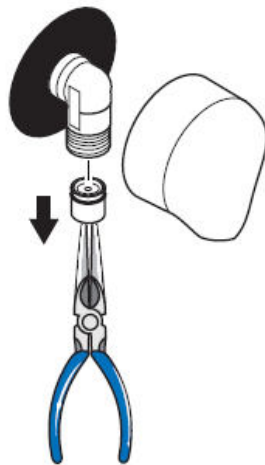

**hansgrohe**

# Asennusohje



**Steel Fixfit**  
35884800



**Steel Fixfit Deluxe**  
35888800  
**Starck Fixfit Deluxe**  
27451XXX



**Montreux  
Fixfit Deluxe**  
16884XXX

Estää itsestään paluuvirtauksen

# AXOR<sup>®</sup>

**hansgrohe**

**Starck 27451XXX**  
**Steel 35884800/35888800**

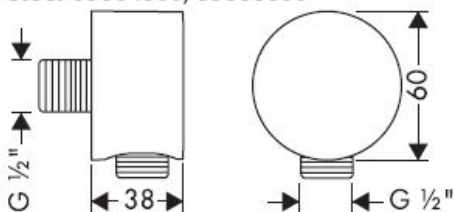

**Montreux 16884XXX**

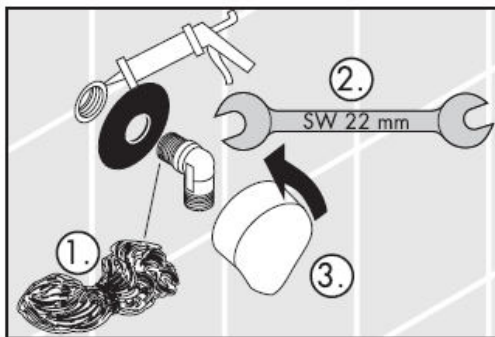
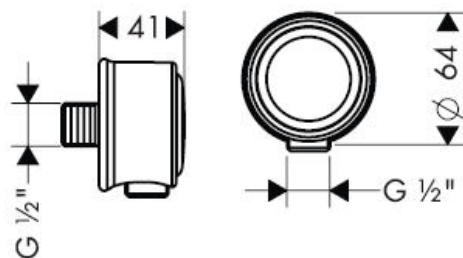

**Fixfit Deluxe 27451XXX/35888800/16884XXX**

DVGW Reg.-Nr.: DW-6511AT2271



**Huomio!** Vastaventtiilin toiminta on normin DIN 1988 mukaan tarkastettava vuosittaan.

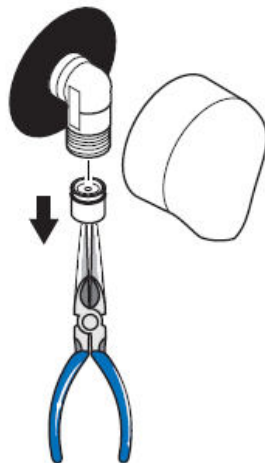

**hansgrohe**

# Monteringsanvisning

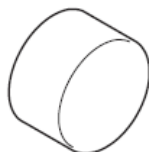

**Steel Fixfit**  
35884800



**Steel Fixfit Deluxe**  
35888800  
**Starck Fixfit Deluxe**  
27451XXX



**Montreux  
Fixfit Deluxe**  
16884XXX

Självspärr mot återflöde

# AXOR<sup>®</sup>

**hansgrohe**

**Starck 27451XXX**  
**Steel 35884800/35888800**

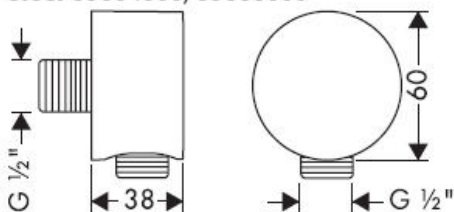

**Montreux 16884XXX**

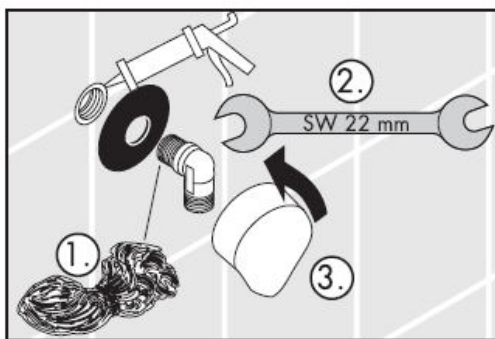
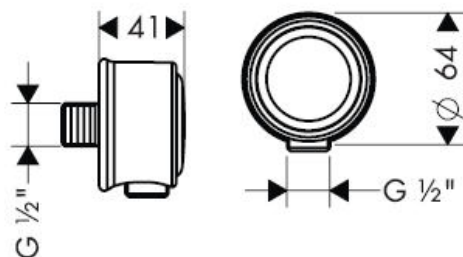

**Fixfit Deluxe 27451XXX/35888800/16884XXX**

DVGW Reg.-Nr.: DW-6511AT2271



**OBS!** Backventilernas funktion måste kontrolleras en gång varje år enligt DIN 1988.

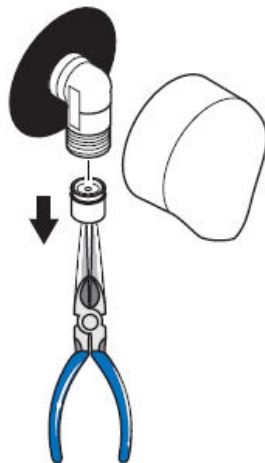

**hansgrohe**



# Montavimo instrukcijos

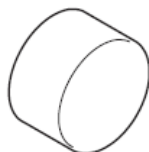

**Steel Fixfit**  
35884800



**Steel Fixfit Deluxe**  
35888800  
**Starck Fixfit Deluxe**  
27451XXX



**Montreux  
Fixfit Deluxe**  
16884XXX

Su atbuliniu vožtuvu

# AXOR<sup>®</sup>

**hansgrohe**

**Starck 27451XXX**  
**Steel 35884800/35888800**

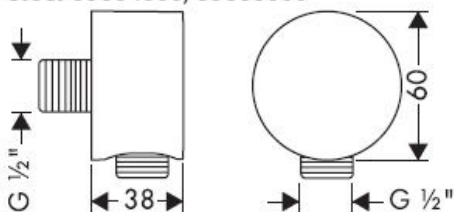

**Montreux 16884XXX**

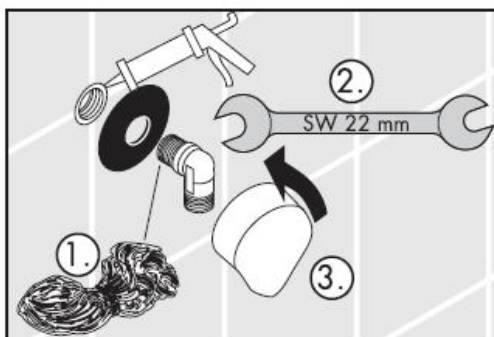
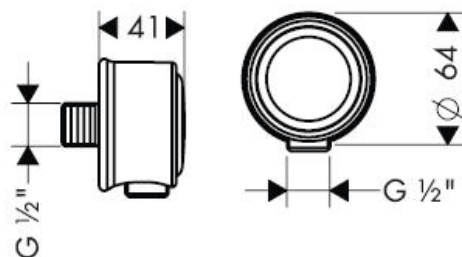

**Fixfit Deluxe 27451XXX/35888800/16884XXX**

DVGW Reg.-Nr.: DW-6511AT2271



**Dėmesio!** Atbulinių vožtuvėlių funkcija, remiantis DIN 1988, vieną kartą metuose privalo būti patikrinta.

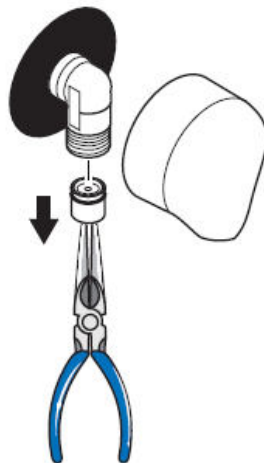

**hansgrohe**

# Uputstva za instalaciju

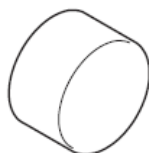

**Steel Fixfit**  
35884800



**Steel Fixfit Deluxe**  
35888800  
**Starck Fixfit Deluxe**  
27451XXX



**Montreux  
Fixfit Deluxe**  
16884XXX

Funkcije samo-čišćenja

# AXOR<sup>®</sup>

**hansgrohe**

**Starck 27451XXX**  
**Steel 35884800/35888800**

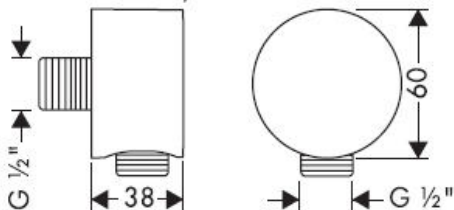

**Montreux 16884XXX**

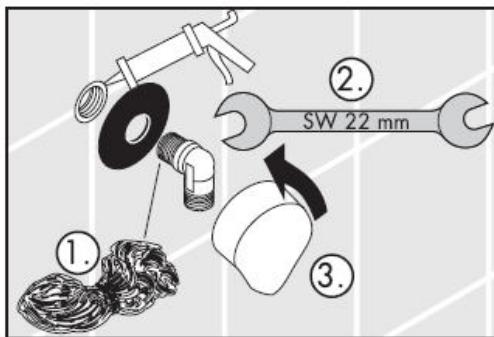
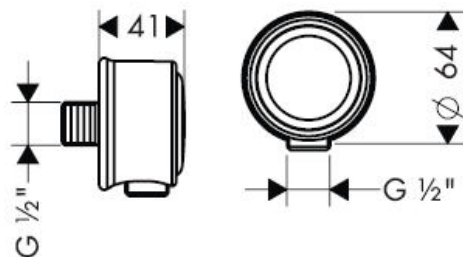

**Fixfit Deluxe 27451XXX/35888800/16884XXX**

DVGW Reg.-Nr.: DW-6511AT2271



**Pažnja!** Nepovratni ventil se mora provjeravati jednom godisnje prema standardu DIN 1988

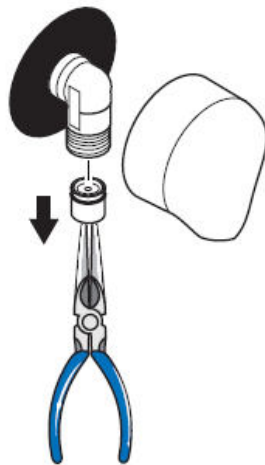

**hansgrohe**

# Montaj kılavuzu



**Steel Fixfit**  
35884800



**Steel Fixfit Deluxe**  
35888800  
**Starck Fixfit Deluxe**  
27451XXX



**Montreux  
Fixfit Deluxe**  
16884XXX

Geri emme önleyici

# AXOR<sup>®</sup>

hansgrohe

**Starck 27451XXX**  
**Steel 35884800/35888800**

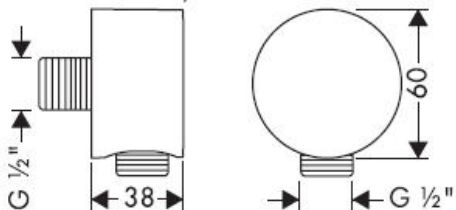

**Montreux 16884XXX**

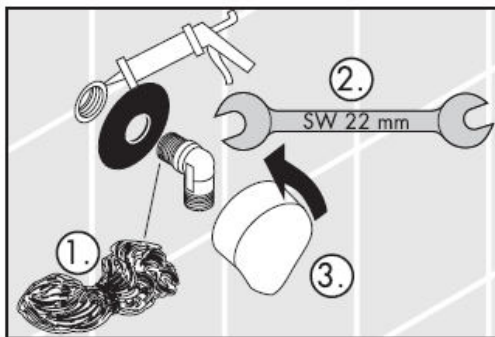
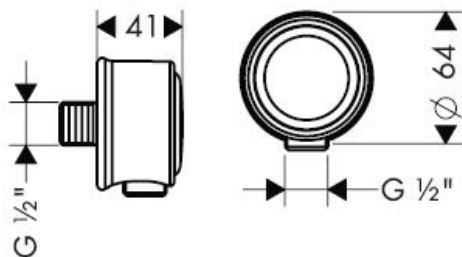

**Fixfit Deluxe 27451XXX/35888800/16884XXX**

DVGW Reg.-Nr.: DW-6511AT2271



**Önemli!** Çek valflara DIN 1988'e göre yılda bir kez çalışma kontrolü yapılmalıdır.

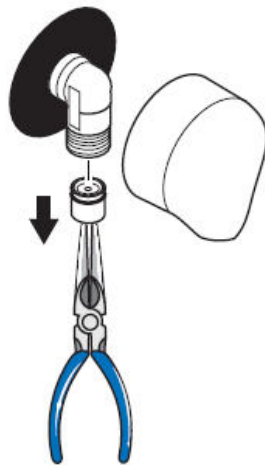

**hansgrohe**

# Instrucțiuni de montare

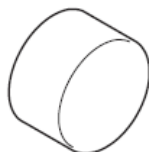

**Steel Fixfit**  
35884800



**Steel Fixfit Deluxe**  
35888800  
**Starck Fixfit Deluxe**  
27451XXX



**Montreux  
Fixfit Deluxe**  
16884XXX

Asigurat contra scurgere înapoi

**AXOR**<sup>®</sup>

**hansgrohe**

**Starck 27451XXX**  
**Steel 35884800/35888800**

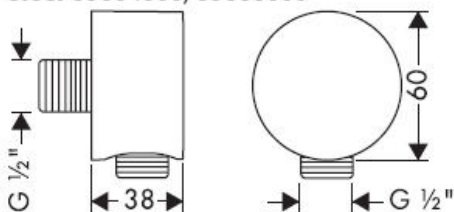

**Montreux 16884XXX**

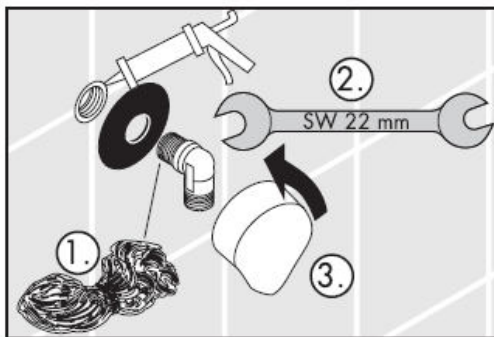
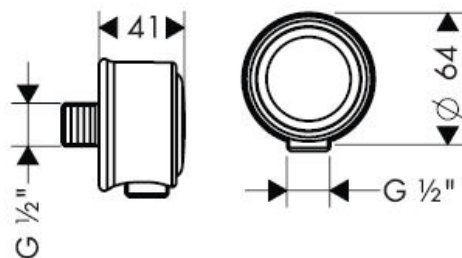

**Fixfit Deluxe 27451XXX/35888800/16884XXX**

DVGW Reg.-Nr.: DW-6511AT2271



**Atenție!** Supapele antiretur trebuie verificate anual conform DIN 1988.

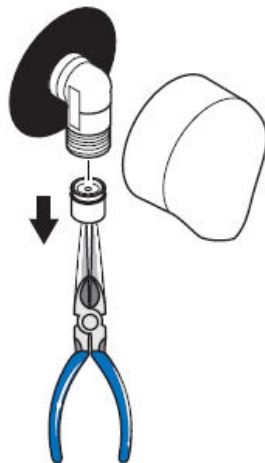

**hansgrohe**



# Οδηγία συναρμολόγησης

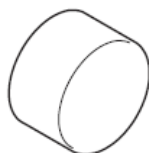

**Steel Fixfit**  
35884800

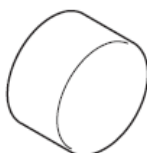

**Steel Fixfit Deluxe**  
35888800  
**Starck Fixfit Deluxe**  
27451XXX

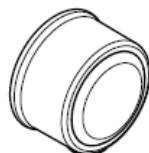

**Montreux  
Fixfit Deluxe**  
16884XXX

Περιλαμβάνει βαλβίδα αντεπιστροφής.

# AXOR<sup>®</sup>

**hansgrohe**

**Starck 27451XXX**  
**Steel 35884800/35888800**

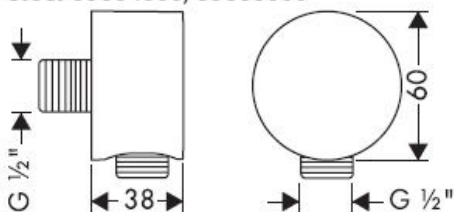

**Montreux 16884XXX**

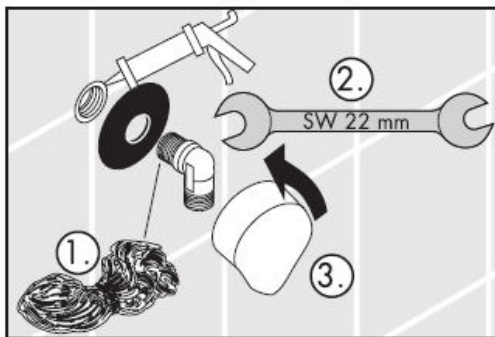
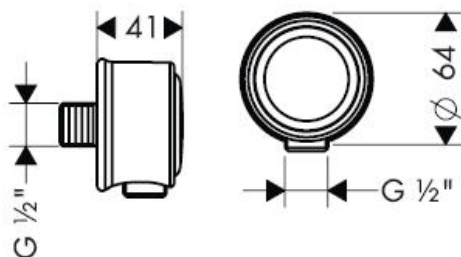

**Fixfit Deluxe 27451XXX/35888800/16884XXX**

DVGW Reg.-Nr.: DW-6511AT2271



**Προσοχή!** Οι βαλβίδες αντεπιστροφής πρέπει να ελέγχονται μια φορά το χρόνο ως προς τη λειτουργία τους, σύμφωνα με το πρότυπο DIN 1988.

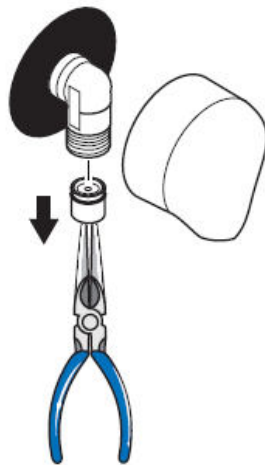

**hansgrohe**

# تعليمات التجميع

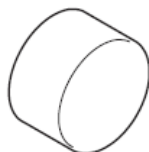

**Steel Fixfit**  
35884800

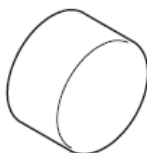

**Steel Fixfit Deluxe**  
35888800  
**Starck Fixfit Deluxe**  
27451XXX



**Montreux  
Fixfit Deluxe**  
16884XXX

التأمين ضد التدفق العكسي

# AXOR<sup>®</sup>

**hansgrohe**

**Starck 27451XXX**  
**Steel 35884800/35888800**

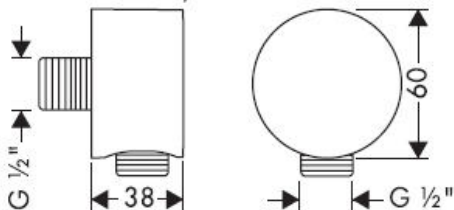

**Montreux 16884XXX**

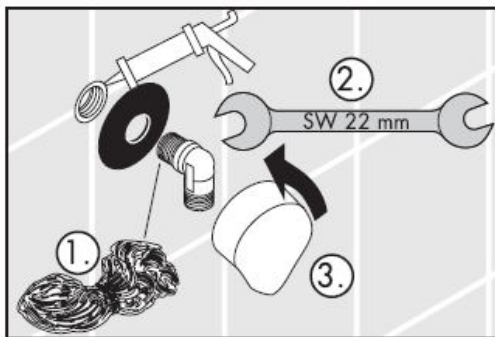
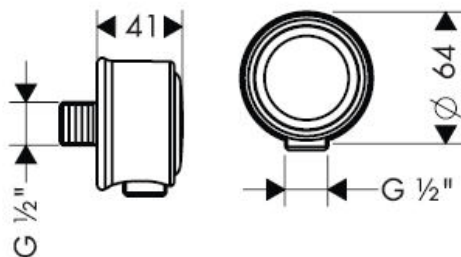

**Fixfit Deluxe 27451XXX/35888800/16884XXX**

DVGW Reg.-Nr.: DW-6511AT2271



يجب فحص صمامات عدم الرجوع مرة واحدة سنوياً. تنبيه!

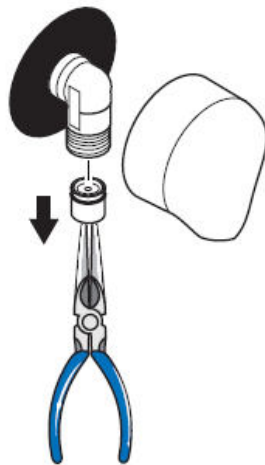

**hansgrohe**

# Navodila za montažo



**Steel Fixfit**  
35884800



**Steel Fixfit Deluxe**  
35888800  
**Starck Fixfit Deluxe**  
27451XXX



**Montreux  
Fixfit Deluxe**  
16884XXX

Zaščita proti povratnemu toku

# AXOR<sup>®</sup>

**hansgrohe**

**Starck 27451XXX**  
**Steel 35884800/35888800**

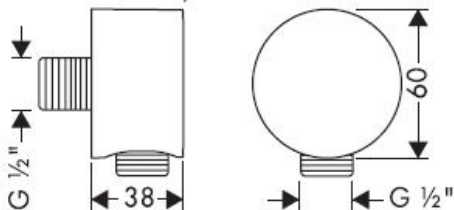

**Montreux 16884XXX**

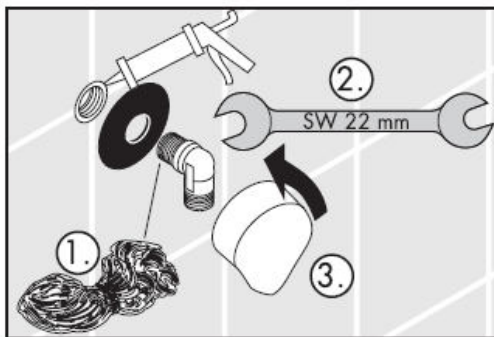
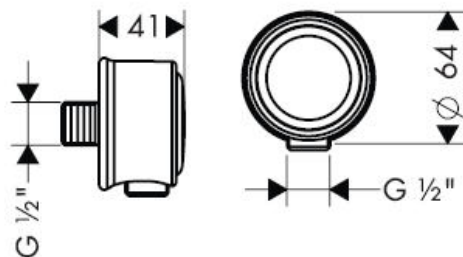

**Fixfit Deluxe 27451XXX/35888800/16884XXX**

DVGW Reg.-Nr.: DW-6511AT2271



**Pozor!** Delovanje protipovratnega ventila je potrebno v skladu z DIN 1988 enkrat letno testirati.

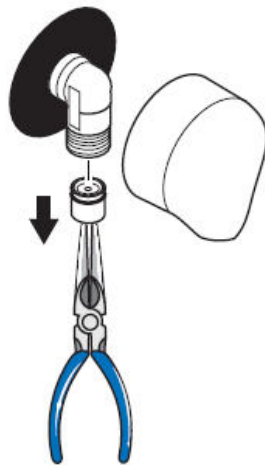

**hansgrohe**

# Paigaldusjuhend

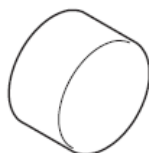

**Steel Fixfit**  
35884800

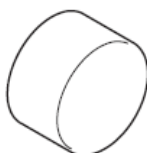

**Steel Fixfit Deluxe**  
35888800  
**Starck Fixfit Deluxe**  
27451XXX



**Montreux  
Fixfit Deluxe**  
16884XXX

tagasivooluklapp

# AXOR<sup>®</sup>

**hansgrohe**

**Starck 27451XXX**  
**Steel 35884800/35888800**

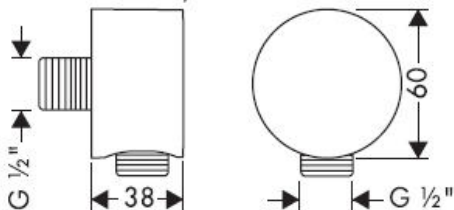

**Montreux 16884XXX**

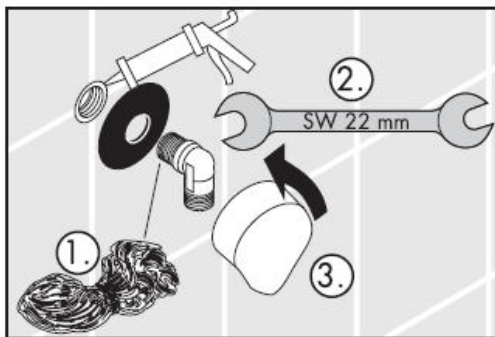
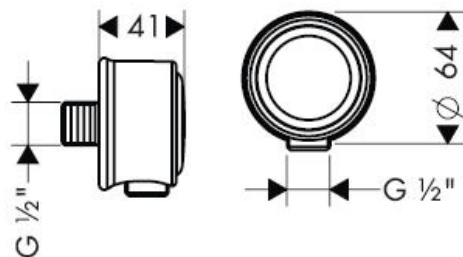

**Fixfit Deluxe 27451XXX/35888800/16884XXX**

DVGW Reg.-Nr.: DW-6511AT2271



**Tähelepanu!** Tagasilöögiklappide toimimist tuleb kontrollida vastavalt standardile DIN 1988 kord aastas.

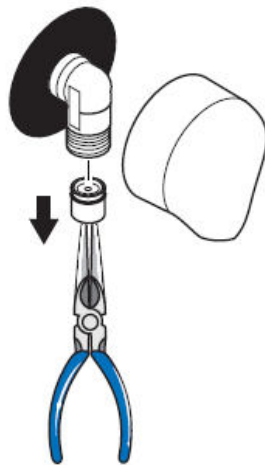

**hansgrohe**



# Montāžas instrukcija

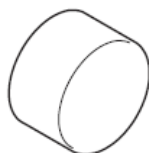

**Steel Fixfit**  
35884800

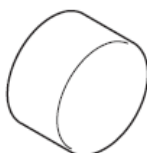

**Steel Fixfit Deluxe**  
35888800  
**Starck Fixfit Deluxe**  
27451XXX



**Montreux  
Fixfit Deluxe**  
16884XXX

Drošības vārsts

**AXOR**<sup>®</sup>

**hansgrohe**

**Starck 27451XXX**  
**Steel 35884800/35888800**

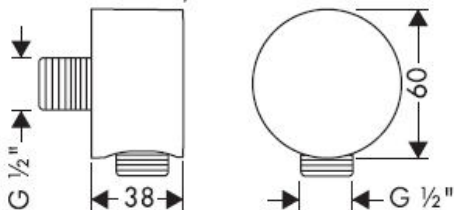

**Montreux 16884XXX**

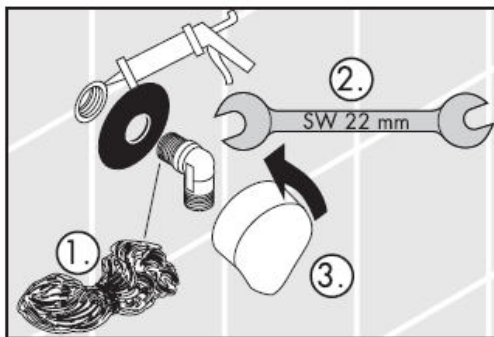
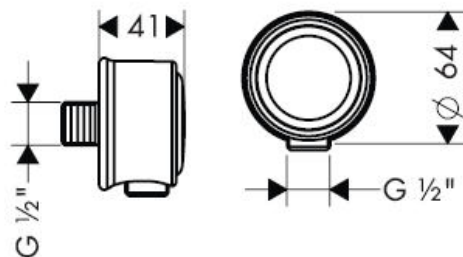

**Fixfit Deluxe 27451XXX/35888800/16884XXX**

DVGW Reg.-Nr.: DW-6511AT2271



**Uzmanību!** Reizi gadā jāpārbauda pretvārsti atbilstoši DIN 1988.

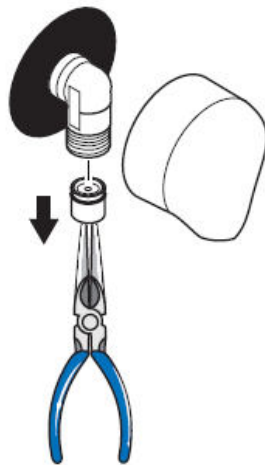

**hansgrohe**

# Uputstvo za montažu

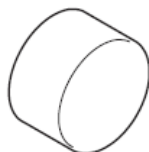

**Steel Fixfit**  
35884800

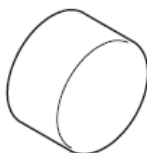

**Steel Fixfit Deluxe**  
35888800  
**Starck Fixfit Deluxe**  
27451XXX



**Montreux  
Fixfit Deluxe**  
16884XXX

Zaštita od povratnog toka

**AXOR**<sup>®</sup>

**hansgrohe**

**Starck 27451XXX**  
**Steel 35884800/35888800**

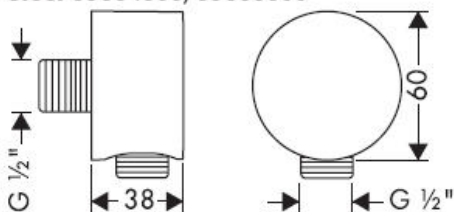

**Montreux 16884XXX**

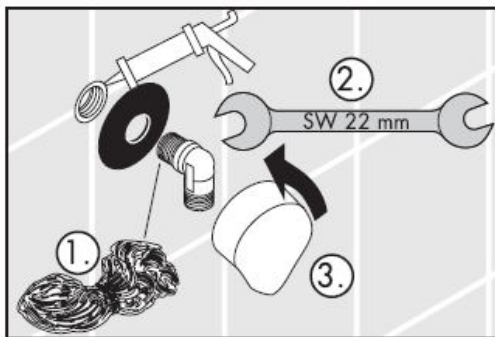
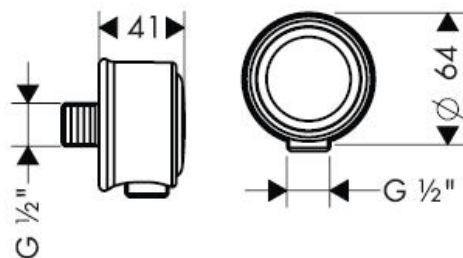

**Fixfit Deluxe 27451XXX/35888800/16884XXX**

DVGW Reg.-Nr.: DW-6511AT2271



**Pažnja!** Nepovratni ventil se mora proveravati jednom godišnje prema standardu DIN 1988.

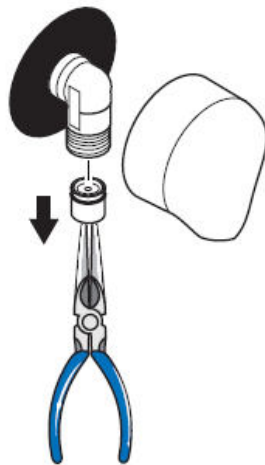

**hansgrohe**

# Montasjeveiledning



**Steel Fixfit**  
35884800



**Steel Fixfit Deluxe**  
35888800  
**Starck Fixfit Deluxe**  
27451XXX



**Montreux  
Fixfit Deluxe**  
16884XXX

Egensikker mot tilbakeflyt

# AXOR<sup>®</sup>

**hansgrohe**

**Starck 27451XXX**  
**Steel 35884800/35888800**

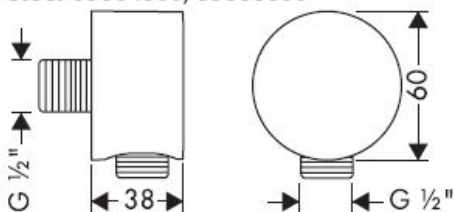

**Montreux 16884XXX**

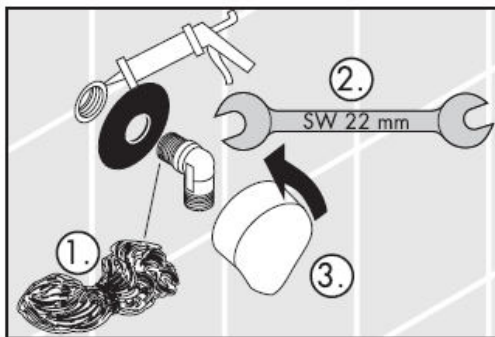
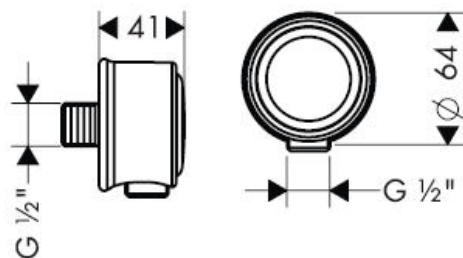

**Fixfit Deluxe 27451XXX/35888800/16884XXX**

DVGW Reg.-Nr.: DW-6511AT2271



**Obs!** I henhold til DIN 1988 skal funksjonen til returløpssperren sjekkes en gang i året.

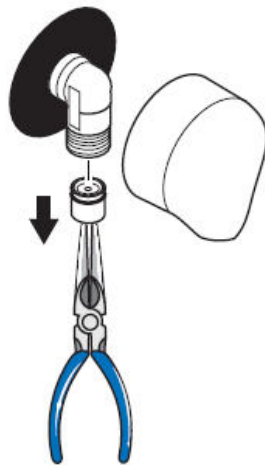

**hansgrohe**

# РЪКОВОДСТВО ЗА МОНТАЖ

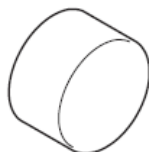

**Steel Fixfit**  
35884800



**Steel Fixfit Deluxe**  
35888800  
**Starck Fixfit Deluxe**  
27451XXX



**Montreux  
Fixfit Deluxe**  
16884XXX

Самозащитен против обратно изтичане

# AXOR<sup>®</sup>

hansgrohe

**Starck 27451XXX**  
**Steel 35884800/35888800**

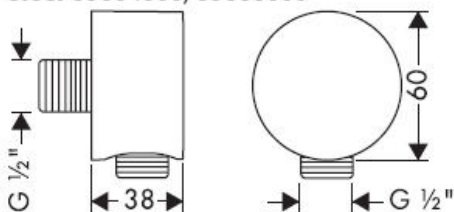

**Montreux 16884XXX**

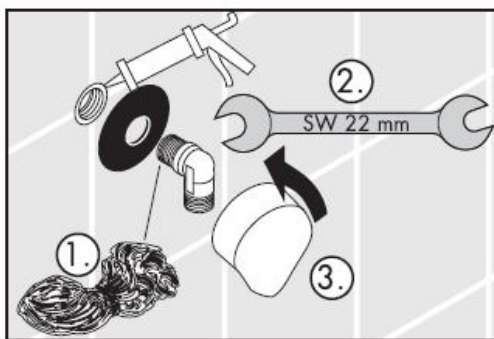
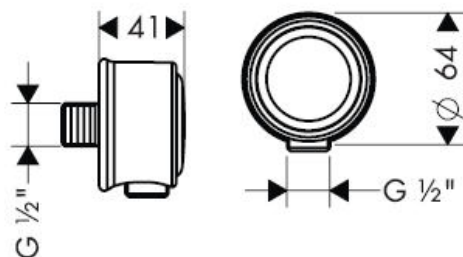

**Fixfit Deluxe 27451XXX/35888800/16884XXX**

DVGW Reg.-Nr.: DW-6511AT2271



**Внимание!** Съгласно DIN 1988 веднъж годишно трябва да се проверява функцията на приспособленията, предотвратяващи обратния поток.

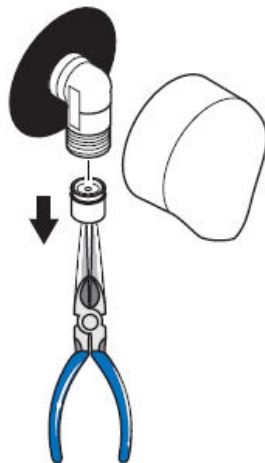

**hansgrohe**



# Udhëzime rreth montimit



**Steel Fixfit**  
35884800

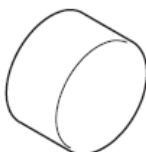

**Steel Fixfit Deluxe**  
35888800  
**Starck Fixfit Deluxe**  
27451XXX



**Montreux  
Fixfit Deluxe**  
16884XXX

Siguresa kundër rrjedhjes në drejtim të kundërt

# AXOR<sup>®</sup>

**hansgrohe**

**Starck 27451XXX**  
**Steel 35884800/35888800**

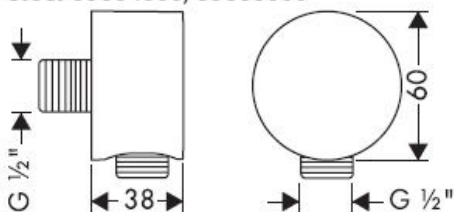

**Montreux 16884XXX**

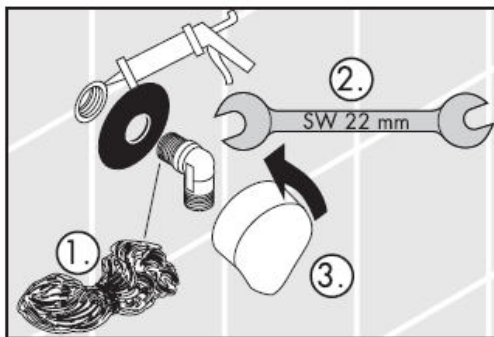
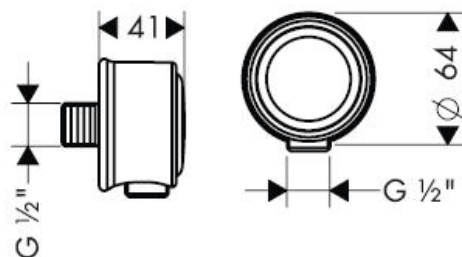

**Fixfit Deluxe 27451XXX/35888800/16884XXX**

DVGW Reg.-Nr.: DW-6511AT2271



**Kujdes!** Penguesit e rrjedhjes në drejtim të kundërt në bazë të normës DIN 1988 duhen kontrolluar njëherë në vit.

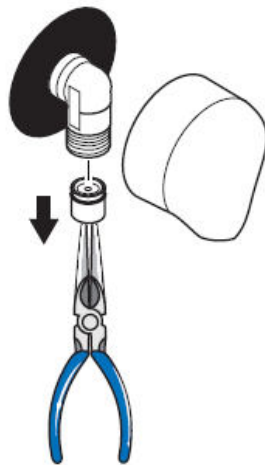

**hansgrohe**