

AXOR®

hansgrohe

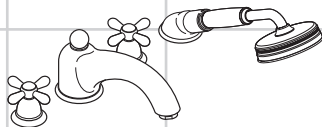



DE	Gebrauchsanleitung / Montageanleitung	2
FR	Mode d'emploi / Instructions de montage	3
EN	Instructions for use / assembly instructions	4
IT	Istruzioni per l'uso / Istruzioni per Installazione	5
ES	Modo de empleo / Instrucciones de montaje	6
NL	Gebruiksaanwijzing / Handleiding	7
DK	Brugsanvisning / Monteringsvejledning	8
PT	Instruções para uso / Manual de Instalação	9
PL	Instrukcja obsługi / Instrukcja montażu	10
CS	Návod k použití / Montážní návod	11
SK	Návod na použitie / Montážny návod	12
ZH	用户手册 / 组装说明	13
RU	Руководство пользователя / Инструкция по монтажу	14
HU	Használati útmutató / Szerelési útmutató	15
FI	Käyttöohje / Asennusohje	16
SV	Brugsanvisning / Monteringsanvisning	17
LT	Vartotojo instrukcija / Montavimo instrukcijos	18
HR	Upute za uporabu / Uputstva za instalaciju	19
TR	Kullanım kılavuzu / Montaj kılavuzu	20
RO	Manual de utilizare / Instrucțiuni de montare	21
EL	Οδηγίες χρήσης / Οδηγία συναρμολόγησης	22
SL	Navodilo za uporabo / Navodila za montažo	23
ET	Kasutusjuhend / Paigaldusjuhend	24
LV	Lietošanas pamācība / Montāžas instrukcija	25
SR	Uputstvo za upotrebu / Uputstvo za montažu	26
NO	Brugsanvisning / Montasjeveiledning	27
BG	Инструкция за употреба / Ръководство за монтаж	28
SQ	Udhëzuesi i përdorimit / Udhëzime rreth montimit	29
AR	دليل الاستخدام / تعليمات التجميع	30



Carlton
17444XXX



Sicherheitshinweise

-  Bei der Montage müssen zur Vermeidung von Quetsch- und Schnittverletzungen Handschuhe getragen werden.
-  Das Produkt darf nur zu Bade-, Hygiene- und Körperreinigungszwecken eingesetzt werden.
-  Große Druckunterschiede zwischen den Kalt- und Warmwasseranschlüssen müssen ausgeglichen werden.
-  Der Kontakt der Brausestrahlen mit empfindlichen Körperstellen (z. B. Augen) muss vermieden werden. Es muss ein ausreichender Abstand zwischen Brause und Körper eingehalten werden.
-  Das Produkt darf nicht als Haltegriff benutzt werden. Es muss ein separater Haltegriff montiert werden.

Montagehinweise

- Die Armatur muss nach den gültigen Normen montiert, gespült und geprüft werden.
- Die der Brause beige packte Siebdichtung muss eingebaut werden, um Schmutzeinspülungen aus dem Leitungsnetz zu vermeiden. Schmutzeinspülungen können die Funktion beeinträchtigen und/oder zu Beschädigungen an Funktionsteilen der Brause führen, für hieraus ergebende Schäden haftet Hansgrohe nicht.

Technische Daten

Betriebsdruck:	max. 1 MPa
Empfohlener Betriebsdruck:	0,1 - 0,5 MPa
Prüfdruck:	1,6 MPa
(1 MPa = 10 bar = 147 PSI)	
Heißwassertemperatur:	max. 80 °C
Empfohlene Heißwassertemperatur:	65 °C
Anschlüsse G 1/2:	kalt rechts - warm links
Eigensicher gegen Rückfließen	

Symbolerklärung



Wartung Rückflussverhinderer (siehe Seite 38)

Rückflussverhinderer müssen gemäß DIN EN 1717 regelmäßig in Übereinstimmung mit nationalen oder regionalen Bestimmungen auf ihre Funktion geprüft werden (mindestens einmal jährlich).

Wartung Secuflex Schlauch (siehe Seite 38)

Das Reinigen wiederholen, wenn im Laufe der Zeit der Auszug schwergängig wird.



Kein essigsäurehaltiges Silikon verwenden!



Maße (siehe Seite 35)



Durchflussdiagramm (siehe Seite 35)

- ① Handbrause
- ② Wanneneinlauf



Serviceteile (siehe Seite 37)

XXX = Farbcodierung

000 = chrom
090 = chrom/gold-optik



Bedienung (siehe Seite 36)



Reinigung (siehe Seite 40)

und beiliegende Broschüre







Prüfzeichen (siehe Seite 34)



Montage siehe Seite 31



Consignes de sécurité

-  Lors du montage, porter des gants de protection pour éviter toute blessure par écrasement ou coupure.
-  Le système de douche ne doit servir qu'à se laver et à assurer l'hygiène corporelle.
-  Il est conseillé d'équilibrer les pressions de l'eau chaude et froide.
-  Éviter le contact du jet de la douchette avec les parties sensibles du corps (telles par ex. que les yeux). Veiller à respecter un écart suffisant entre la douchette et le corps
-  Le produit ne doit pas servir de poignée. Monter pour cela une poignée séparée.

Instructions pour le montage

- La robinetterie doit être installée, rincée et contrôlée conformément aux normes valables.
- Le joint à filtre fourni avec la pomme de douche à main doit être installé afin de retenir des impuretés du système de conduites. Ceux-ci pourraient influencer le fonctionnement de ce produit et même endommager des pièces mobiles. Des réclamations à la suite de l'usage de la pomme de douche sans joint-tamis de hansgrohe ne peuvent pas faire partie de notre garantie.

Informations techniques

Pression de service autorisée:	max. 1 MPa
Pression de service conseillée:	0,1 – 0,5 MPa
Pression maximum de contrôle: (1 MPa = 10 bar = 147 PSI)	1,6 MPa
Température d'eau chaude:	max. 80 °C
Température recommandée:	65 °C
Raccordement G 1/2:	froide à droite chaude à gauche

Avec dispositif anti-retour

Description du symbole



Entretien clapet anti-retour (voir page 38)

Les clapets anti-retour doivent être examinés régulièrement conformément à la norme EN 1717 ou conformément aux dispositions nationales ou régionales quant à leur fonction (au moins une fois par an).

Entretien Secuflex tube flexible (voir page 38)

Répétez cette action lorsque l'extraction devient difficile.



Ne pas utiliser de silicone contenant de l'acide acétique!



Dimensions (voir page 35)



Diagramme du débit
(voir page 35)

- ① Douchette
- ② Bec déverseur



Spare parts (see page 37)

XXX = Couleurs

000 = chromé
090 = chromé/or l'optique



Instructions de service
(voir page 36)



Nettoyage (voir page 40)

et brochure ci-jointe







Classification acoustique et débit (voir page 34)



Montage voir page 31



Safety Notes

-  Gloves should be worn during installation to prevent crushing and cutting injuries.
-  The shower system may only be used for bathing, hygienic and body cleansing purposes.
-  The hot and cold supplies must be of equal pressures.
-  Do not allow the streams of the shower touch sensitive body parts (such as your eyes). An adequate distance must be kept between the shower and you.
-  The product may not be used as a holding handle. A separate handle must be installed.

Installation Instructions

- The fitting must be installed, flushed and tested after the valid norms.
- The mesh washer must be insert to protect the overhead shower against incoming dirt by pipework. Incoming dirt leads to defects or/and can damage parts of the shower; such caused faults voids all liability and guarantee claims.

Technical Data

Operating pressure:	max. 1 MPa
Recommended operating pressure:	0,1 – 0,5 MPa
Test pressure:	1,6 MPa
(1 MPa = 10 bar = 147 PSI)	
Hot water temperature:	max. 80°C
Recommended hot water temp.:	65°C
Connections G 1/2:	cold right - hot left
anti-pollution function	

Symbol description



Maintenance non return valve (see page 38)

The non return valves must be checked regularly according to DIN EN 1717 in accordance with national or regional regulations (at least once a year).

Maintenance Secuflex hose (see page 38)

Repeat cleaning when pull out becomes difficult.



Do not use silicone containing acetic acid!



Dimensions (see page 35)



Flow diagram (see page 35)

- ① Hand shower
- ② Bath Spout



Spare parts (see page 37)

XXX = Colors

000 = chrome plated
090 = chrome plated/gold plated



Operation (see page 36)



Cleaning (see page 40)

and enclosed brochure







Test certificate (see page 34)



Assembly see page 31



Indicazioni sulla sicurezza

-  Durante il montaggio, per pevitare ferite da schiacciamento e da taglio bisogna indossare guanti protettivi.
-  Il sistema doccia deve essere utilizzato esclusivamente per l'igiene del corpo.
-  **Attenzione!** Compensare le differenze di pressione tra i collegamenti dell'acqua fredda e dell'acqua calda.
-  Bisogna evitare il contatto fra il getto della doccia e parti del corpo delicate (ad es. gli occhi). Fra il soffione ed il corpo va mantenuta una distanza sufficiente.
-  Il prodotto non deve essere utilizzato come maniglia, questa deve essere motata separatamente.

Istruzioni per il montaggio

- La rubinetteria deve essere installata, pulita e testata secondo le istruzioni riportate!
- Per proteggere la soffione doccia da eventuali impurita provenienti dalle tubazioni dell'acqua, deve essere inserito il filtro nell'impugnatura della doccia stessa. Tali impurita possono infatti causare difetti e/o danneggiare parti della doccia; in questo caso la Hansgrohe non risponde dei danni.

Dati tecnici

Pressione d'uso:	max. 1 MPa
Pressione d'uso consigliata:	0,1 - 0,5 MPa
Pressione di prova:	1,6 MPa
(1 MPa = 10 bar = 147 PSI)	
Temperatura dell'acqua calda:	max. 80 °C
Temp. dell'acqua calda consigliata:	65 °C
Raccordi: G 1/2:	fredda a destra calda a sinistra

Sicurezza antiriflusso

Descrizione simbolo



Manutenzione valvola antiriflusso (vedi pagg. 38)

La valvola di non ritorno deve essere controllata regolarmente come da DIN EN 1717, secondo le normative nazionali e regionali (almeno una volta all'anno).

Manutenzione Secuflex flessibile (vedi pagg. 38)

Questa azione di pulizia deve essere ripetuta in caso, con il passare del tempo, l'apertura della placca diventi difficoltosa.



Non utilizzare silicone contenente acido acetico!



Ingombri (vedi pagg. 35)



Diagramma flusso (vedi pagg. 35)

- ① Doccetta
- ② Bocca di erogazione



Parti di ricambio (vedi pagg. 37)

XXX = Trattamento

000 = cromato
090 = cromo/dorato ottica



Procedura (vedi pagg. 36)



Pulitura (vedi pagg. 40)

e brochure allegata







Segno di verifica (vedi pagg. 34)





Indicaciones de seguridad

-  Durante el montaje deben utilizarse guantes para evitar heridas por aplastamiento o corte.
-  La grifería solo debe ser utilizada para fines de baño, higiene y limpieza corporal.
-  Grandes diferencias de presión en servicio entre agua fría y agua caliente deben equilibrarse.
-  Debe evitarse el contacto del chorro del pulverizador con partes sensibles del cuerpo (por ej. ojos). Debe mantenerse una distancia suficiente entre pulverizador y cuerpo.
-  El producto no debe ser utilizado como un elemento de sujeción. Debe montarse un elemento de sujeción separado.

Indicaciones para el montaje

- El grifo tiene que ser instalado, probado y testado, según las normas en vigor.
- La junta de filtración que se suministra con la ducha mural evita que las partículas de suciedad procedentes de las tuberías lleguen a la ducha mural. Debe colocarse entre el flexo y la ducha mural. Infiltraciones de suciedad deterioran el funcionamiento de la ducha mural y pueden causar daños en el interior de la misma que no están cubiertas por la garantía de Hansgrohe.

Datos técnicos

Presión en servicio:	max. 1 MPa
Presión recomendada en servicio:	0,1 - 0,5 MPa
Presión de prueba: (1 MPa = 10 bar = 147 PSI)	1,6 MPa
Temperatura del agua caliente:	max. 80 °C
Temp. recomendada del agua caliente:	65 °C
Racores excéntricos G 1/2:	a la derecha frío - a la izquierda caliente
Seguro contra el retorno	

Descripción de símbolos



Mantenimiento Válvula antirretorno (ver página 38)

Las válvulas anti-retorno tienen que ser controladas regularmente según la norma DIN EN 1717, en acuerdo con las regulaciones nacionales o regionales (una vez al año, por lo menos).

Mantenimiento Flexo Secuflex (ver página 38)

Repetir la limpieza, cuando el tiempo aumenta la resistencia al extraerlo.



No utilizar silicona que contiene ácido acético!



Dimensiones (ver página 35)



Diagrama de circulación (ver página 35)

- ① Teleducha
- ② Caño de bañera



Repuestos (ver página 37)

XXX = Acabados

000 = cromado
090 = cromo/oro óptica



Manejo (ver página 36)



Limpiar (ver página 40)

y folleto anexo



Marca de verificación (ver página 34)





Veiligheidsinstructies

- ⚠ Bij de montage moeten ter voorkoming van knel- en snijwonden handschoenen worden gedragen.
- ⚠ Het douchesysteem mag alleen voor het wassen, hygiënische doeleinden en voor de lichaamreiniging worden gebruikt.
- ⚠ Grote drukverschillen tussen de koud- en warmwater-toevoer dienen vermeden te worden.
- ⚠ Het contact van de douchestraal met gevoelige lichaamsdelen (bijv. ogen) moet worden voorkomen. Er moet voldoende afstand tussen douche en lichaam aangehouden worden.
- ⚠ Het product mag niet als handgreep worden gebruikt. Er moet een aparte handgreep gemonteerd worden.

Montage-instructies

- Leidingen doorspoelen volgens Norm. De mengkraan vervolgens monteren en controleren.
- Het bij de hoofddouche verpakte zeefje moet worden ingebouwd om vuil uit de waterleiding te weren. Vuil uit de leidingen kan de werking van de hoofddouche negatief beïnvloeden en/of de hoofddouche beschadigen. Voor deze schade is Hansgrohe niet verantwoordelijk.

Technische gegevens

Werkdruk: max.	max. 1 MPa
Aanbevolen werkdruk:	0,1 - 0,5 MPa
Getest bij:	1,6 MPa
(1 MPa = 10 bar = 147 PSI)	
Temperatuur warm water:	max. 80 °C
Aanbevolen warm water temp.:	65 °C
Aansluitingen G 1/2:	koud rechts - warm links
Beveiligd tegen terugstromen	

Symboolbeschrijving



Onderhoud terugslagklep (zie blz. 38)

Keerklappen moeten volgens DIN EN 1717 regelmatig en volgens plaatselijk geldende eisen op het functioneren gecontroleerd worden. (Tenminste een keer per jaar)

Onderhoud secuflex slang (zie blz. 38)

U kunt deze handeling herhalen indien na verloop van tijd het uittrekken van de douche wat zwaarder gaat.

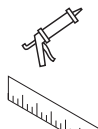

Gebruik geen zuurhoudende silicone!



Maten (zie blz. 35)



Doorstroomdiagram (zie blz. 35)

- ① Handdouche
- ② Baduitloop



Service onderdelen (zie blz. 37)

XXX = Kleuren

000 = verchromd
090 = chroom/vergulde-look



Bediening (zie blz. 36)



Reinigen (zie blz. 40)

en bijgevoegde brochure



Keurmerk (zie blz. 34)



Montage zie blz. 31



Sikkerhedsanvisninger

- ⚠ Ved monteringen skal der bruges handsker for at undgå kvæstelser og snitsår.
- ⚠ Brusersystemet må kun bruges til bade-, hygiejne og rengøringsformål.
- ⚠ Større trykforskelle mellem koldt og varmt vand bør udjævnes.
- ⚠ Bruserstrålens kontakt med sensitive områder (f.eks. øjne) skal undgås. Der skal være en tilstrækkelig afstand mellem bruseren og kroppen.
- ⚠ Produktet må ikke bruges som håndtag. Der skal monteres et separat håndtag.

Monteringsanvisninger

- Ifølge gældende regler, skal armaturet monteres, skylles igennem og afprøves.
- Den vedlagte smudsfangssi skal indsættes i bruseren for at undgå snavs fra rørsystemet. Indskyllet snavs kan have indflydelse på bruserens funktion og/eller føre til beskadigelser på håndbruserens funktionsdele.

Tekniske data

Driftstryk:	max. 1 MPa
Anbefalet driftstryk:	0,1 – 0,5 MPa
Prøvetryk:	1,6 MPa
(1 MPa = 10 bar = 147 PSI)	
Varmtvandstemperatur:	max. 80 °C
Anbefalet varmtvandstemperatur:	65 °C
Tilslutninger G 1/2:	Koldt højre - varmt venstre

Med indbygget kontraventil

Symbolbeskrivelse



Service Kontraventil (se s. 38)

Ifølge DIN EN 1717 skal gennemstrømningsbegrænsere i overensstemmelse med nationale regler afprøves regelmæssigt (mindst en gang om året).

Service Secuflex slange (se s. 38)

Venligst gentag rengøringen såfremt udtrækket med tiden bliver trægt.



Der må ikke benyttes eddikesyreholdig silikone!



Målene (se s. 35)



Gennemstrømningsdiagram (se s. 35)

- ① Håndbruser
- ② Kartud



Reserve dele (se s. 37)

XXX = Overflade

000 = Krom
090 = Krom/guld optic



Brugsanvisning (se s. 36)



Rengøring (se s. 40)

og vedlagt brochure







Godkendelse (se s. 34)





Avisos de segurança

-  Durante a montagem devem ser utilizadas luvas de protecção, de modo a evitar ferimentos resultantes de entalamentos e de cortes.
-  O sistema de duche só pode ser utilizado para fins de higiene pessoal.
-  Grandes diferenças entre as pressões das águas quente e fria devem ser compensadas.
-  Deve-se evitar o contacto dos jactos de água com partes do corpo sensíveis (p. ex. olhos). É necessário manter uma distância suficiente entre o chuveiro e o corpo.
-  O produto não pode ser utilizado como pega de apoio. Tem que ser montada uma pega separada.

Avisos de montagem

- A misturadora deve ser instalada, purgada e testada de acordo com as normas em vigor.
- O filtro de rede deve ser colocado para proteger o chuveiro de areias e resíduos provenientes da tubagem. Resíduos e areias podem danificar componentes, ou provocar mau funcionamento do chuveiro; as avarias assim provocadas anulam a nossa responsabilidade e anulam a nossa garantia.

Dados Técnicos

Pressão de funcionamento:	max. 1 MPa
Pressão de func. recomendada:	0,1 – 0,5 MPa
Pressão testada:	1,6 MPa
(1 MPa = 10 bar = 147 PSI)	
Temperatura da água quente:	max. 80 °C
Temp. água quente recomendada:	65 °C
Ligações G 1/2:	fria à direita - quente à esquerda
Função anti-retorno e anti-vácuo	

Descrição do símbolo



Manutenção Válvula anti-retorno (ver página 38)

As válvulas anti-retorno devem ser verificadas regularmente de acordo com a DIN EN 1717 segundo os regulamentos nacionais ou regionais (pelo menos uma vez por ano).

Manutenção Secuflex flexível (ver página 38)

Limpe ontra vez se for ainda aifcil de puxar can o tempo.



Não utilizar silicone que contenha ácido acético!



Medidas (ver página 35)



Fluxograma (ver página 35)

- ① Chuveiro de mão
- ② Entrada de banheira



Peças de substituição (ver página 37)

XXX = Acabamentos

000 = cromado
090 = cromado/ouro ótica



Funcionamento (ver página 36)



Limpeza (ver página 40)

e brochura em anexo







Marca de controlo (ver página 34)





Wskazówki bezpieczeństwa

-  Aby uniknąć zranień, takich jak zgniecenia czy przecięcia, podczas montażu należy nosić rękawice.
-  Pysznica może być używany tylko do kąpieli, higieny i czyszczenia ciała.
-  Znaczne różnice ciśnień na dopływach ciepłej i zimnej wody muszą zostać wyrównane.
-  Należy unikać kontaktu strumienia wyływającego z głowicy z wrażliwymi częściami ciała (np. oczami). Należy zachowywać odpowiednią odległość pomiędzy głowicą a ciałem.
-  Produktu nie wolno używać jako uchwytu do trzymania się. Należy zamontować osobno uchwyt.

Wskazówki montażowe

- Armatura musi być zamontowana, przepłukana i wypróbowana według obowiązujących norm.
- Znajdujące się przy prysznicu siłko musi zostać zainstalowane, aby zatrzymać zanieczyszczenia z instalacji. Przedostające się zanieczyszczenia mogą mieć ujemny wpływ na działanie i/lub prowadzić do usterek w działaniu elementów prysznica. Za powstałe z tego tytułu szkody firma Hansgrohe nie ponosi odpowiedzialności.

Dane techniczne

Ciśnienie robocze:	maks. 1 MPa
Zalecane ciśnienie robocze:	0,1 - 0,5 MPa
Ciśnienie próbne:	1,6 MPa
(1 MPa = 10 bary = 147 PSI)	
Temperatura wody gorącej:	maks. 80 °C
Zalecana temperatura wody gorącej:	65 °C
Przyłącza G 1/2:	Zimna prawo - ciepła lewo
Samoistnie zabezpieczony przed przepływem zwrotnym	

Opis symbolu



Konserwacja Zabezpieczenie przed przepływem zwrotnym (patrz strona 38)

Zgodnie z normą DIN EN 1717, krajowymi i miejscowymi przepisami, działanie zabezpieczeń przed przepływem zwrotnym musi być kontrolowane (przynajmniej raz w roku).

Konserwacja Wąż Secuflex (patrz strona 38)

W przypadku, gdy wyciąg pracuje z wysiłkiem, powtórzyc czyszczenie.



Nie stosować silikonów zawierających kwas octowy!



Wymiary (patrz strona 35)



Schemat przepływu (patrz strona 35)

- ① Pysznica ręczny
- ② Wylewka wannowa



Części serwisowe (patrz strona 37)

XXX = kody wykończenia powierzchni

000 = chrom
090 = chrom/złoty szlachetna

Obsługa (patrz strona 36)



Czyszczenie (patrz strona 40)

i dołączona broszura







Znak jakości (patrz strona 34)





Bezpečnostní pokyny

-  Pro zabránění řezným zraněním a pohmožděním je nutné při montáži nosit rukavice.
-  Produkt smí být používán pouze ke koupání a za účelem tělesné hygieny.
-  Je nutné vyrovnat velké rozdíly tlaku mezi přípoji studené a teplé vody.
-  Je nutné zabránit kontaktu vodních paprsků sprchy s měkkými částmi těla (např. očima). Je nutné dodržovat dostatečný odstup mezi sprchou a tělem.
-  Produkt nesmí být používán jako madlo. Je nutné namontovat samostatné madlo.

Pokyny k montáži

- Armatura se musí montovat, proplachovat a testovat podle platných norem.
- Do přívodu musí být zabudováno se sprchou dodávané sítko, aby zachycovalo nečistoty vyplavené z vodovodní sítě. Vyplavené nečistoty mohou ovlivnit funkci sprchy a nebo mohou vést i k jejímu poškození. Na takto vzniklé škody se nevztahuje záruka firmy Hansgrohe.

Technické údaje

Provozní tlak:	max. 1 MPa
Doporučený provozní tlak:	0,1 - 0,5 MPa
Zkušební tlak:	1,6 MPa
(1 MPa = 10 bar = 147 PSI)	
Teplota horké vody:	max. 80 °C
Doporučená teplota horké vody:	65 °C
Přípoje G 1/2:	studená vpravo - t eplá vlevo

Vlastní jističení proti zpětnému nasátí.

Popis symbolů



Údržba zpětný ventil (viz strana 38)

U zpětných ventilů se musí podle DIN EN 1717 v souladu s národními nebo regionálními předpisy testovat jejich funkčnost (alespoň jednou ročně).

Údržba hadice Secuflex (viz strana 38)

Opakovat čištění, pokud je po čase vytáhnout obtížné.



Nepoužívat silikon s obsahem kyseliny octové!



Rozměry (viz strana 35)



Diagram průtoku
(viz strana 35)

- ① Ruční sprcha
- ② Vanový vtok



Servisní díly (viz strana 37)

XXX = kód povrchové úpravy

000 = chrom

090 = chrom/zlato ocel



Ovládání (viz strana 36)



Čištění (viz strana 40)

a přiložená brožura







Zkušební značka (viz strana 34)





Bezpečnostné pokyny

-  Pri montáži musíte nosiť rukavice, aby ste predišli pomliaždeninám a rezným poraneniam.
-  Produkt sa smie používať len na kúpanie a telesnú hygienu.
-  Veľké rozdiely v tlaku medzi prípojkami studenej a teplej vody musia byť vyrovnané.
-  Vyhýbajte sa kontaktu vodného lúča sprchy s citlivými miestami tela (napr. oči). Dodržiavajte dostatočnú vzdialenosť medzi sprchou a telom.
-  Výrobok sa nesmie používať ako držadlo. K tomu účelu sa musí namontovať samostatné držadlo.

Pokyny pre montáž

- Armatúra sa musí montovať, preplachovať a testovať podľa platných noriem.
- Do prívodu musí byť zabudované so sprchou dodávané sítko, aby zachytilo nečistoty vyplavené z vodovodnej siete. Vyplavené nečistoty môžu ovlivniť funkciu sprchy, alebo spôsobiť jej poškodenie. Na takto vzniknuté škody sa nevzťahuje záruka firmy Hansgrohe.

Technické údaje

Prevádzkový tlak:	max. 1 MPa
Doporučený prevádzkový tlak:	0,1 – 0,5 MPa
Skúšobný tlak:	1,6 MPa
(1 MPa = 10 bar = 147 PSI)	
Teplota teplej vody:	max. 80 °C
Doporučená teplota teplej vody:	65 °C
Prípoje G 1/2:	studená vpravo - teplá vľavo

Vlastná poistka proti spätnému nasatiu.

Popis symbolov



Údržba obmedzovač spätného nasatia (viď strana 38)

Pri spätných ventiloch sa musí podľa DIN EN 1717 v súlade s národnými alebo regionálnymi predpismi testovať ich funkčnosť (aspoň raz ročne).

Údržba hadica Secuflex (viď strana 38)

Zopakujte čistenie, ak sa v priebehu času sťažilo vyťahovanie.



Nepoužívať silikón s obsahom kyseliny octovej!



Rozmery (viď strana 35)



Diagram prietoku (viď strana 35)

- ① Ručná sprcha
- ② Vaňový vtok



Servisné diely (viď strana 37)

XXX = kód povrchovej úpravy

000 = chróm
090 = chróm/zlato ocel



Obsluha (viď strana 36)



Čistení (viď strana 40)

a priložená brožúra



Osvedčenie o skúške (viď strana 34)





安全技巧

- △ 装配时为避免挤压和切割受伤，必须戴上手套。
- △ 淋浴系统只允许作为洗浴、卫生和洁身之用。
- △ 冷热水管间过大的压力差必须予以平衡。
- △ 必须避免让身体敏感部位（如眼睛）接触到莲蓬头喷水。必须保持莲蓬头与人头之间有足够的距离。
- △ 该产品不得作扶柄使用。必须安装单独的扶柄。

安装提示

- 必须按照现行的规定安装，冲洗和测试产品。
- 必须装上花洒所自带的滤网密封垫，以过滤管道里的杂质污物。杂质污物会影响花洒的功能和/或损坏花洒的功能部件，由此而产生的产品损坏不属于汉斯格雅的保修范围。

技术参数

工作压强:	最大 1 MPa
推荐工作压强:	0,1 0,5 MPa
测试压强:	1,6 MPa
(1 MPa = 10 bar = 147 PSI)	
热水温度:	最大 80° C
推荐热水温度:	65° C
连接管线G 1/2:	左热右冷
自动防止回流	

符号说明



保养 单向阀 (参见第 38 页)

单向阀必须在符合国家或当地的法律的情况下按照DIN EN 1717定期检查（至少一年一次）。

保养 Secuflex 软管 (参见第 38 页)

当手持花洒随着时间的推移变得抽拉困难时，重复上述清理工作。



请勿使用含有乙酸的硅！



大小 (参见第 35 页)



流量示意图 (参见第 35 页)

- ① 手持花洒
- ② 浴缸出水口



备用零件 (参见第 37 页)

XXX = 颜色代码

000 = 镀铬
090 = 镀铬/黑色



操作 (参见第 36 页)



清洗 (参见第 40 页)

并附有小手册



检验标记 (参见第 34 页)



安装 参见第 31 页



Указания по технике безопасности

- ⚠ Во время монтажа следует надеть перчатки во избежание прищемления и порезов.
- ⚠ Изделие разрешается использовать только в гигиенических целях: для принятия ванны и личной гигиены.
- ⚠ донного клапа. Перед установкой смесителя необходимо регулировочными кранами выровнять давление холодной и горячей воды при помощи вентилей регулирующих подачу воды в квартиру.
- ⚠ Не допускайте попадания струи воды из разбрызгивателя на чувствительные части тела (например, на глаза). Разбрызгиватель следует устанавливать на достаточном расстоянии от тела.
- ⚠ Изделие запрещается использовать в качестве рукоятки. Следует устанавливать специальную рукоятку.

Указания по монтажу

- Смеситель должен быть смонтирован по действующим нормам и в соответствии с настоящей инструкцией, проверен на герметичность и безупречность работы.
- Для предотвращения попадания частиц грязи из водопроводной сети необходимо установить фильтр, прилагаемый к ручному душу. Частицы грязи могут нарушить отдельные функции и/или привести к повреждению функциональных деталей ручного душа, Hansgrohe не несет ответственность за повреждения вследствие отсутствия фильтра.

Технические данные

Рабочее давление:	не более. 1 МПа
Рекомендуемое рабочее давление:	0,1 – 0,5 МПа
Давление:	1,6 МПа
(1 МПа = 10 bar = 147 PSI)	
Температура горячей воды:	не более. 80 °C
Рекомендуемая темп. гор. воды:	65 °C
Подключение G 1/2:	холодная справа горячая слева

укомплектован клапаном обратного тока воды

Описание символов



Техническое обслуживание Защита обратного тока воды (см. стр. 38)

Защита обратного тока должна регулярно проверяться (минимум один раз в год) по стандарту DIN EN 1717 или в соответствии с национальными или региональными нормативами

Техническое обслуживание Шланг Secuflex (см. стр. 38)

Повторите очистку, если со временем вытягивание затрудняется.



Не применяйте силикон, содержащий уксусную кислоту.



Размеры (см. стр. 35)



Схема потока (см. стр. 35)

- ① Ручной душ
- ② Водозабор



Комплект (см. стр. 37)

XXX = Код цвета поверхности

000 = хром

090 = хром/глянцевое золото



Эксплуатация (см. стр. 36)



Очистка (см. стр. 40)

и прилагаемая брошюра



Знак технического контроля (см. стр. 34)





Biztonsági utasítások

- ⚠ A szerelésnél a zúródások és vágási sérülések elkerülése érdekében kesztyűt kell viselni.
- ⚠ A terméket csak fürdéshez, mosakodáshoz, és egészségügyi tisztálkodáshoz szabad használni.
- ⚠ A hidegvíz- és a melegvíz-csatlakozások közötti nagy nyomáskülönbséget kikell egyenlíteni!
- ⚠ Kerülni kell a zuhanyugár érintkezését érzékeny testrészekkel (pl. szemek). Be kell tartani a megfelelő távolságot a zuhanyfej és a test között.
- ⚠ A terméket nem szabad kapaszkodónak használni. Ehhez külön kapaszkodót kell felszerelni.

Szerelési utasítások

- A csaptelepet az érvényben lévő előírásoknak megfelelően kell felszerelni, átöblíteni és ellenőrizni.
- A kézi zuhanyhoz csomagolt szűrőtömítést be kell szerelni a vízhálózatból származó szennyeződések kiküszöbölésére. A beáramló szennyeződések akadályozhatják és / vagy teljesen tönkre is tehetik a zuhany funkciót. Az ezekből adódó károkért a Hansgrohe nem felel.

Műszaki adatok

Üzemi nyomás:	max. 1 MPa
Ajánlott üzemi nyomás:	0,1 - 0,5 MPa
Nyomáspróba:	1,6 MPa
(1 MPa = 10 bar = 147 PSI)	
Forróvíz hőmérséklet:	max. 80 °C
Forróvíz javasolt hőmérséklete:	65 °C
G 1/2 csatlakozás:	hideg jobbra - meleg balra

Visszafolyás gátlóval

Szimbólumok leírása



Karbantartás
Visszacsapószelep (lásd a 38. oldalon)

A visszafolyásgátlók működése a DIN EN 1717 szabványnak megfelelően, a nemzeti vagy területi rendelkezésekkel összhangban, évente egyszer ellenőrizendő!

Karbantartás Secuflex tömlő
(lásd a 38. oldalon)

Ismételje meg a tisztítást, ha időközben elnehezül a kifolyás.

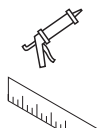

Ne használjon ecetsavtartalmú szilikon!



Méretet (lásd a 35. oldalon)



Árfolyási diagramm
(lásd a 35. oldalon)

- ① Kézi zuhany
- ② Kádbevezetés



Tartozékok (lásd a 37. oldalon)

XXX = Színkódok

000 = króm
090 = króm/arany-hatású



Használat (lásd a 36. oldalon)



Tisztítás (lásd a 40. oldalon)

és mellékelt bróssúrával



Vizsgajel (lásd a 34. oldalon)



Szerelés lásd a 31. oldalon



Turvallisuusohjeet

- △ Asennuksessa on käytettävä käsineitä puristumien ja viltojen aiheuttamien tapaturmien estämiseksi.
- △ Suihkujärjestelmää saa käyttää ainoastaan kylpy-, hygienia- ja puhdistustarkoituksiin.
- △ Suuret paine-erot kylmä- ja kuumavesiliitäntöjen välillä on tasattava.
- △ Suihkuveden kontaktia herkkien ruumiinosien (esim. silmien) kanssa on vältettävä. Suihkun ja vartalon välissä on oltava riittävä väli.
- △ Tuotetta ei saa käyttää kädensijana. On asennettava erillinen kädensija.

Asennusohjeet

- Kaluste on asennettava, huuhdeltava ja tarkastettava voimassa olevien määräysten mukaisesti.
- Käsisuihkun mukana toimitettu sihtitiiviste on asennettava paikalleen, jotta lian huuhtoutuminen vesijohtoverkostosta käsisuihkun estyy. Huuhtoutuvat likahiukkaset voivat häiritä suihkun toimintaa tai vahingoittaa toimintaosia, Hansgrohe ei vastaa tästä aiheutuneista vahingoista.

Tekniset tiedot

Käyttöpaine:	maks. 1 MPa
Suosittelut käyttöpaine:	0,1 - 0,5 MPa
Koestuspaine:	1,6 MPa
(1 MPa = 10 bar = 147 PSI)	
Kuuman veden lämpötila:	maks. 80 °C
Kuuman veden suosituslämpötila:	65 °C
Liittimet G 1/2:	kylmä oikealla - kuuma vasemmalla

Estää itsestään paluuvirtauksen

Merkin kuvaus



Huolto Vastaventiili (katso sivu 38)

Vastaventiilin toiminta on tarkastettava säännöllisesti paikallisten ja kansallisten määräysten mukaisesti (DIN EN 1717, vähintään kerran vuodessa).

Huolto Secuflex letku (katso sivu 38)

Toista puhdistus, jos ulosveto tulee ajan kuluessa raskaaksi.



Älä käytä etikkahappopitoista silikonia!



Mitat (katso sivu 35)



Virtausdiagrammi (katso sivu 35)

- ① Käsisuihku
- ② Vedentulo ammeeseen



Varaosat (katso sivu 37)

XXX = Värikoodi

000 = kromi
090 = kromi/kultaoptiikka



Käyttö (katso sivu 36)



Puhdistus (katso sivu 40)

ja oheinen esite



Koestusmerkki (katso sivu 34)





Säkerhetsanvisningar

- ⚠ Handskar ska bäras under monteringsarbetet så att man kan undvika kläm- och skärskadorgen werden.
- ⚠ Produkten får bara användas till kroppshygien med bad och dusch.
- ⚠ Stora tryckskillnader mellan anslutningarna för varmt och kallt vatten måste utjämnas.
- ⚠ Undvik att rikta duschstrålarna mot känsliga kroppsdelar (t. ex. ögonen). Det måste finnas ett tillräckligt stort avstånd mellan duschen och kroppen.
- ⚠ Produkten får inte användas som handtag. Ett separat handtag måste monteras.

Monteringsanvisningar

- Armaturen måste installeras, genomspolas och testas enligt gällande föreskrifter.
- Silpackningen som följer med duschen måste monteras för att undvika att smuts från ledningsnätet tränger in. Smuts som spolas in kan påverka funktionerna och/eller leda till skador på funktionsdelar i duschen. Hansgrohe fränsäger sig allt ansvar för skador som kan härledas till detta.

Tekniska data

Driftstryck:	max. 1 MPa
Rek. driftstryck:	0,1 - 0,5 MPa
Tryck vid provtryckning:	1,6 MPa
(1 MPa = 10 bar = 147 PSI)	
Varmvattentemperatur:	max. 80 °C
Rek. varmvattentemp.:	65 °C
Anslutningar G 1/2:	kallt höger - varmt vänster
Självspärr mot återflöde	

Simbolio aprašymas



Skötsel Backventil (se sidan 38)

Backventilers funktion måste kontrolleras regelbundet enligt nationella eller regionala bestämmelser i enlighet med DIN EN 1717 (minst en gång per år).

Skötsel Secuflex slang (se sidan 38)

Upprepa rengöringen om utdragsenheten börjar bli trög.



Använd inte silikon som innehåller ättiksyra!



Måtten (se sidan 35)



Flödesschema (se sidan 35)

- ① Handdusch
- ② Badkarskran



Reservdelar (se sidan 37)

XXX = Färgkodning

000 = krom
090 = krom/guld-optik



Hantering (se sidan 36)



Rengöring (se sidan 40)

och medföljande broschyr







Testsigill (se sidan 34)





Saugumo technikos nurodymai

-  Apsaugai nuo užspaudimo ir įsijovimo montavimo metu mūvėkite pirštines.
-  Gaminys turi būti naudojamas tik maudymuisi, kūno higienai ir švarai palaikyti.
-  Turi būti išlyginti šalto ir karšto slėgio nelygumai.
-  Būtina vengti dušo vandens srovės kontakto su jautriomis kūno vietomis (pvz., akimis). Todėl būtina laikytis tinkamu atstumu nuo dušo.
-  Gaminys neturi būti naudojamas kaip rankena. Rankena montuojama atskirai.

Montavimo instrukcija

- Maišytuvą privalo būti montuojamas ir išbandomas pagal veikiančias normas ir šią instrukciją.
- Tinklelis, kuris yra rankų dušas pakuotėje, privalo būti įstatytas, kad būtų apsaugota nuo išorės nešvarumų. Nešvarumai gali pakenkti rankų dušas funkcionalumui ir (arba) sugadinti rankų dušas funkcines dalis. Tokiu atveju „Hansgrohe“ atsakomybės nepriima.

Techniniai duomenys

Darbinis slėgis: ne daugiau kaip 1 MPa
 Rekomenduojamas slėgis: 0,1 – 0,5 MPa
 Bandomasis slėgis: 1,6 MPa
 (1 MPa = 10 barų = 147 PSI)
 Karšto vandens temperatūra: ne daugiau kaip 80 °C
 Rekomenduojama karšto vandens temperatūra: 65 °C
 Prijungimas G 1/2: Šaltas vanduo dešinėje, karštas - kairėje

Su atbuliniu vožtuvu

Simbolio aprašymas



Techninis aptarnavimas atbulinis vožtuvas (žr. psl. 38)

Atbulinio vožtuvo apsauga privalo būti tikrinama reguliariai (mažiausiai kartą per metus) pagal DIN EN1717 arba pagal galiojančias nacionalines arba regionines normas.

Techninis aptarnavimas "Secuflex" žarna (žr. psl. 38)

Valyti pakartotinai, jei ištraukti būna vis sunkiau.



Nenaudokite silikono, kurio sudėtyje yra acto rūgšties!



Išmatavimai (žr. psl. 35)



Pralaidumo diagrama (žr. psl. 35)

- ① Rankų dušas
- ② Vonios įeiga



Atsarginės dalys (žr. psl. 37)

XXX = Spalva

000 = chrom
 090 = chrominė (aukso optika)



Eksploatacija (žr. psl. 36)



Valymas (žr. psl. 40)

ir pridėdama brošiūra



Bandyimo pažyma (žr. psl. 34)





Sigurnosne upute

- ⚠ Prilikom montaže se radi sprječavanja prignječenja i posjekotina moraju nositi rukavice.
- ⚠ Proizvod se smije primjenjivati samo za kupanje, tuširanje i osobnu higijenu.
- ⚠ Velika razlika u pritisku između vruće i hladne vode mora biti izbalansirana.
- ⚠ Mora se izbjegavati kontakt mlaza iz tuša s osjetljivim dijelovima tijela (npr. očima). Tijelo korisnika mora biti dovoljno udaljeno od tuša.
- ⚠ Proizvod ne smije služiti za pridržavanje. U tu se svrhu mora postaviti zaseban rukohvat.

Upute za montažu

- Cijevi moraju biti postavljene, isprane i testirane prema važećim normama.
- Filter potrebno je ugraditi kako bi se regulirao protok vode i smanjio dotok prljavštine. Za eventualna oštećenja uzrokovana prljavštinom proizvođač Hansgrohe nije odgovoran.

Tehnički podaci

Najveći dopušteni tlak:	tlak 1 MPa
Preporučeni tlak:	0,1 – 0,5 MPa
Probni tlak:	1,6 MPa
(1 MPa = 10 bar = 147 PSI)	
Temperatura vruće vode:	tlak 80 °C
Preporučena temperatura vruće vode:	65 °C
Spojevi G 1/2:	hladna desno – topla lijevo
Funkcije samo-čišćenja	

Opis simbola



Održavanje nepovratni ventil (pogledaj stranicu 38)

Ispravnost nepovratnog ventila mora se redovito provjeravati prema standardu DIN EN 1717 i u skladu sa važećim propisima (najmanje jednom godišnje).

Održavanje Secuflex gipka cijev (pogledaj stranicu 38)

Ukoliko nakon nekog vremena voda i dalje slabo istječe, ponovite čišćenje

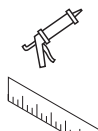

Nemojte koristiti silikon koji sadrži octenu kiselinu!

Mjere (pogledaj stranicu 35)



Dijagram protoka (pogledaj stranicu 35)

- ① Ručni tuš
- ② Ispust u kadu



Rezervni dijelovi (pogledaj stranicu 37)

XXX = Boje

000 = krom
090 = optika krom/zlato



Upotreba (pogledaj stranicu 36)



Čišćenje (pogledaj stranicu 40)

i priložena brošura



Oznaka testiranja (pogledaj stranicu 34)





⚠️ Güvenlik uyarıları

- ⚠️ Montaj esnasında ezilme ve kesilme gibi yaralanmaları önlemek için eldiven kullanılmalıdır.
- ⚠️ Duş sistemi yalnızca banyo, hijyen ve beden temizliği amaçları doğrultusunda kullanılabilir.
- ⚠️ Sıcak ve soğuk su bağlantıları arasında büyük basınç farklılıkları varsa, bu basınç farklılıklarının dengelenmesi gerekir.
- ⚠️ Püskürtme başlıklarının hassas organlara teması (örn. gözler) önlenmelidir. Püskürtücü ile beden arasında yeterli mesafe bırakılmalıdır.
- ⚠️ Ürün tutma kolu olarak kullanılmamalıdır. Ayrı bir tutma kolu monte edilmelidir.

Montaj açıklamaları

- Batarya monte edilmeli, geçerli normlardan sonra akis testi yapılmalıdır.
- El duşu kafasına eklenmiş olan süzgeç contası, boru şebekesinden sızan kirlerin önüne geçmek için, yerinde monte edilmelidir. İçeri sızan bu kirler duşun fonksiyonunu sekteleyebilir ve/veya duşun fonksiyon parçaları üzerinde hasarlara sebep olabilir, bu yüzden meydana gelen hasarlardan Hansgrohe sorumlu tutulamaz.

Teknik bilgiler

İşletme basıncı:	azami 1 MPa
Tavsiye edilen işletme basıncı:	0,1 – 0,5 MPa
Kontrol basıncı:	1,6 MPa
(1 MPa = 10 bar = 147 PSI)	
Sıcak su sıcaklığı:	azami 80 °C
Tavsiye edilen su ısısı:	65 °C
G 1/2 bağlantılar:	soğuk sağ - sıcak sol
Geri emme önleyici	

Simge açıklaması



Bakım Çek valf (Bakınız sayfa 38)

DIN EN 1717 ve ulusal standartlar doğrultusunda Çek valfler düzenli olarak kontrol edilmelidir. (en az yılda bir kez)

Bakım Secuflex hortum (Bakınız sayfa 38)

Zaman için dışarı çekme zorlaşırsa temizliği tekrarlayın.



Asetik asit içeren silikon kullanmayın!



Ölçüleri (Bakınız sayfa 35)



Akış diyagramı (Bakınız sayfa 35)

- ① El duşu
- ② Küvet su girişi



Yedek Parçalar (Bakınız sayfa 37)

XXX = Renkler

000 = krom
090 = krom/altın-optik



Kullanımı (Bakınız sayfa 36)



Temizleme (Bakınız sayfa 40)

ve birlikte verilen broşür







Kontrol işareti (Bakınız sayfa 34)





Instrucțiuni de siguranță

-  La montare utilizați mănuși pentru evitarea contuziunilor și tăierii mâinilor.
-  Sistemul de duș poate fi utilizat doar pentru spălarea, menținerea igienei și curățarea corpului.
-  Diferențele de presiune mari între alimentarea cu apă rece și apă caldă trebuie echilibrate.
-  Evitați contactul jetului de apă cu părțile de corp sensibile (de ex. ochii). Țineți dușul la o distanță corespunzătoare de corp.
-  Nu este permisă utilizarea produsului pe post de mâner. este nevoie de montarea unui mâner corespunzător.

Instrucțiuni de montare

- Bateria trebuie montată, clătită și verificată conform normelor în vigoare.
- Montați garnitura de filtru livrată împreună cu capătul de duș de mână pentru evitarea pătrunderii impurităților din rețeaua de alimentare. Impuritățile pătrunse pot influența funcționarea aparatului și/sau provoca deteriorarea capătului de duș. Garanția nu acoperă aceste daune.

Date tehnice

Presiune de funcționare:	max. 1 MPa
Presiune de funcționare recomandată:	0,1 – 0,5 MPa
Presiune de verificare:	1,6 MPa
(1 MPa = 10 bar = 147 PSI)	
Temperatura apei calde:	max. 80 °C
Temperatura recomandată a apei calde:	65 °C
Racorduri G 1/2 : r	ece - dreapta / cald - stânga

Asigurat contra scurgere înapoi

Descrierea simbolurilor



Întreținere Supapă de rețineră (vezi pag. 38)

Supapele antiretur trebuie verificate regulat conform DIN EN 1717 și standardele naționale sau regionale (cel puțin o dată pe an).

Întreținere Furtun Secuflex (vezi pag. 38)

Curățați aparatul dacă furtunul nu se mai poate extrage ușor.



Nu utilizați silicon cu conținut de acid acetic!



Dimensiuni (vezi pag. 35)



Diagrama de debit (vezi pag. 35)

- ① Duș de mână
- ② Gură de admisiune



Piese de schimb (vezi pag. 37)

XXX = cod de culori

000 = crom
090 = crom/auriu optic



Utilizare (vezi pag. 36)



Curățare (vezi pag. 40)

și broșura alăturată



Certificat de testare (vezi pag. 34)





⚠ Υποδείξεις ασφαλείας

- ⚠ Για να αποφύγετε τραυματισμούς κατά τη συναρμολόγηση πρέπει να φοράτε γάντια.
- ⚠ Το προϊόν επιτρέπεται να χρησιμοποιείται μόνο σαν μέσο λουτρού, υγιεινής και καθαρισμού του σώματος.
- ⚠ Οι διαφορές της πίεσης μεταξύ της σύνδεσης κρύου και ζεστού νερού θα πρέπει να αντισταθμίζονται.
- ⚠ Η επαφή δέσμης νερού του ντους με ευαίσθητες περιοχές του σώματος (π.χ. μάτια) πρέπει να αποφεύγεται. Διατηρείτε επαρκή απόσταση ανάμεσα στο ντους και το σώμα.
- ⚠ Το προϊόν δεν επιτρέπεται να χρησιμοποιείται σαν λαβή στήριξης. Για τον σκοπό αυτό πρέπει να τοποθετηθεί ξεχωριστή λαβή στήριξης.

Οδηγίες συναρμολόγησης

- Η μπαταρία πρέπει να τοποθετηθεί, να πλυθεί και να ελεγχθεί με βάση τους ισχύοντες κανόνες υδραυλικής τέχνης
- Πρέπει να εγκατασταθεί το παρέμβυσμα φίλτρου που συνοδεύει τον καταιονιστήρα κατά τέτοιο τρόπο, ώστε να αποφεύγονται ρύποι που προέρχονται από το δίκτυο ύδρευσης. Οι ρύποι από το δίκτυο ύδρευσης μπορούν να επηρεάσουν αρνητικά και/ή να προξενήσουν ζημία στα λειτουργικά τμήματα του καταιονιστήρα (ντους). Τέτοιου είδους ζημιές δεν καλύπτονται από την εγγύηση Hansgrohe.

Τεχνικά Χαρακτηριστικά

Λειτουργία πίεσης:	έως 1 MPa
Συνιστώμενη λειτουργία πίεσης:	0,1 – 0,5 MPa
Πίεση ελέγχου:	1,6 MPa
(1 MPa = 10 bar = 147 PSI)	
Θερμοκρασία ζεστού νερού:	έως 80 °C
Συνιστώμενη θερμοκρασία ζεστού νερού:	65 °C
Συνδέσεις G 1/2:	κρύο δεξιά – ζεστό αριστερά

Περιλαμβάνει βαλβίδα αντεπιστροφής.

Περιγραφή συμβόλων



Συντήρηση Βαλβίδα αντεπιστροφής (βλ. σελίδα 38)

Οι βαλβίδες αντεπιστροφής πρέπει να ελέγχονται τακτικά ως προς τη λειτουργία τους, σύμφωνα με το πρότυπο DIN EN 1717, σε σχέση με τους ισχύοντες εθνικούς ή τοπικούς κανόνες (το ελάχιστο μια φορά το χρόνο).

Συντήρηση Σπирάλ Secuflex μήκους (βλ. σελίδα 38)

Επαναλάβετε τον καθαρισμό, εάν καταστεί δύσκολη η έξοδος νερού στη διάρκεια του χρόνου.



Μην χρησιμοποιείτε σιλικόνη που περιέχει οξικό οξύ!



Διαστάσεις (βλ. σελίδα 35)



Διάγραμμα ροής (βλ. σελίδα 35)

- ① Καταιονιστήρας χειρός
- ② Είσοδος νερού στη μπανιέρα



Ανταλλακτικά (βλ. σελίδα 37)

XXX = Χρώματα

000 = Επιχρωμιωμένο
090 = Επιχρωμιωμένο/οπτική χρυσού



Χειρισμός (βλ. σελίδα 36)



Καθαρισμός (βλ. σελίδα 40)

και συνημμένο φυλλάδιο







Σήμα ελέγχου (βλ. σελίδα 34)





Varnostna opozorila

-  Pri montaži je treba nositi rokavice, da se preprečijo poškodbe zaradi zmečkanja ali urezov.
-  Ta izdelek se sme uporabljati le z namenom umivanja, vzdrževanja higiene in telesne nege.
-  Velike razlike v tlaku med priključkom za mrzlo in priključkom za toplo vodo je potrebno izravnati.
-  Izogibati se je treba stiku prhalnega curka z občutljivimi deli telesa (npr. očmi). Med telesom in prho mora biti vedno zadosten razmik.
-  Proizvoda ne smete uporabljati kot držalnega ročaja. V ta namen je treba montirati poseben ročaj.

Instructions pour le montage

- Armaturo je potrebno montirati, splakniti in testirati v skladu z veljavnimi predpisi.
- Filter, ki je priložen ročni prhi, je potrebno vgraditi, da prho zaščitimo pred umazanijo iz vodovodne napeljave. Umazanija lahko okvari ali poškoduje dele ročne prhe. Za tako nastalo škodo Hansgrohe ne odgovarja.

Tehnični podatki

Delovni tlak:	maks. 1 MPa
Priporočeni delovni tlak:	0,1 – 0,5 MPa
Preskusni tlak:	1,6 MPa
(1 MPa = 10 bar = 147 PSI)	
Temperatura tople vode:	maks. 80 °C
Priporočena temperatura tople vode:	65 °C
Priključki G 1/2:	mrzla desno - toplo levo
Zaščita proti povratnemu toku	

Opis simbola



Vzdrževanje Protipovratni ventil (glejte stran 38)

Delovanje protipovratnega ventila je potrebno v skladu z DIN EN 1717 in skladno z državnimi in regionalnimi določili redno testirati (najmanj enkrat letno).

Vzdrževanje Secuflex gibka cev (glejte stran 38)

Iz vlečno prho ponovno očistite, če jo je težko izvleči.



Ne smete uporabiti silikona, ki vsebuje ocetno kislino!



Mere (glejte stran 35)



Diagram pretoka (glejte stran 35)

- ① Ročna prha
- ② Vtok v kad



Rezervni deli (glejte stran 37)

XXX = Barve

000 = krom
090 = krom/pozlačena



Upravljanje (glejte stran 36)



Čiščenje (glejte stran 40)

in priložena brošura



Preskusni znak (glejte stran 34)



Montaža Glejte stran 31.



Ohutusjuhised

- ⚠ Kandke paigaldamisel muljumis- ja löikevigastuste vältimiseks kindaid.
- ⚠ Toodet tohib kasutada ainult pesemis-, hügieeni- ja kehapihustamisesmärkidel.
- ⚠ Kui külma ja kuuma vee ühenduste surve on väga erinev, tuleb need tasakaalustada.
- ⚠ Duši veejoad ei tohi kokku puutuda tundlike kehaosadega (nt silmad). Jätke duši ja keha vahele piisav vahe.
- ⚠ Toodet ei tohi kasutada käepidemena. Paigaldage eraldi käepide.

Paigaldamisjuhised

- Seadmestiku paigaldamine, läbipesu ja kontrollimine peab toimuma vastavalt kehtivatele normidele.
- Kaitsmaks dušši torust tuleva mustuse eest, on vaja paigaldada dušiga kaasasolev mustusesõel. Sissetulev mustus võib funktsioneerimist kahjustada ja/või rikkuda duši detaile. Sellest tulenevate kahjude eest Hansgrohe ei vastuta.

Tehnilised andmed

Töörõhk	maks. 1 MPa
Soovitatav töörõhk:	0,1 – 0,5 MPa
Kontrollsurve:	1,6 MPa
(1 MPa = 10 baari = 147 PSI)	
Kuuma vee temperatuur:	maks. 80 °C
Soovitatav kuuma vee temperatuur:	65 °C
ühendused G 1/2:	külm paremal, kuum vasakul

tagasivooluklapp

Sümbolite kirjeldus



Hooldus tagasilöögiklapp (vt lk 38)

Tagasilöögiklappide toimimist tuleb kooskõlas riiklike ja regionaalsete määrustega regulaarselt kontrollida vastavalt standardile DIN EN 1717 (vähemalt kord aastas).

Hooldus Secuflex'i voolik (vt lk 38)

Puhastage uuesti, kui väljatõmbamine raskemaks muutub.



Ärge kasutage äädikhapet sisaldavat silikooni!



Mõõtude (vt lk 35)



Läbivooludiagramm (vt lk 35)

- ① Käsidušš
- ② Vanni kraan



Varuosad (vt lk 37)

XXX = Värvikood

000 = kroom
090 = kroom/kuld optik



Kasutamine (vt lk 36)



Puhastamine (vt lk 40)

ja kaasasolev brošüür



Kontrollsertifikaat (vt lk 34)





Drošības norādes

- ⚠ Montāžas laikā, lai izvairītos no saspiedumiem un iegriezumiem, nepieciešams nēsāt cimdus.
- ⚠ Šo produktu drīkst izmantot tikai, lai mazgātos, higiēnai un ķermeņa tīrīšanai.
- ⚠ Jāizlīdzina spiediena atšķirības starp aukstā un karstā ūdens pievadiem.
- ⚠ Nepieciešams izvairīties no dušas strūkļas tieša kontakta ar jutīgām ķermeņa daļām (piem., acīm). Nepieciešams ievērot pietiekošu attālumu starp dušu un ķermeni.
- ⚠ Šo produktu nedrīkst izmantot kā roku balstu. Nepieciešams uzmontēt atsevišķu roku balstu.

Norādījumi montāžai

- Jaucējkrāns jāmontē, jāskalo un jāpārbauda atbilstoši spēkā esošajām normām.
- Jāiemontē dušas komplektā esošais filtrs, lai novērstu neīrurumu ieplūšanu no ūdens vada. Ieskalotie neīrurumi var traucēt dušas funkciju un / vai arī izraisīt rokas dušas daļu bojājumus, par kuriem Hansgrohe nenes atbildību.

Tehniskie dati

Darba spiediens:	maks. 1 MPa
leteicamais darba spiediens:	0,1 - 0,5 MPa
Pārbaudes spiediens:	1,6 MPa
(1 MPa = 10 bar = 147 PSI)	
Karstā ūdens temperatūra:	maks. 80 °C
leteicamā karstā ūdens temperatūra:	65 °C
G 1/2 pieslēgumi:	aukstsais pa labi - karstsais pa kreisi

Drošības vārsts

Simbolu nozīme



Apkope Pretvārsts (skat. 38. lpp.)

Regulāri jāpārbauda pretvārsta funkcija saskaņā ar DIN EN 1717 saistībā ar nacionālajiem vai vietējiem noteikumiem (vismaz vienreiz gadā).

Apkope Secuflex šļūtene (skat. 38. lpp.)

Tīrīšana atkārti, ja laika gaitā izvilksana kļūst apgrūtināša.



Neizmantot silikonu, kas satur etiķskābi!



Izmērus (skat. 35. lpp.)



Caurplūdes diagramma (skat. 35. lpp.)

- ① Rokas duša
- ② Vannas tekne



Rezerves daļas (skat. 37. lpp.)

XXX = Krāsas

000 = hroma
090 = hroma/zelta



Lietošana (skat. 36. lpp.)



Tīrīšana (skat. 40. lpp.)

un klāt pievienotais buklets







Pārbaudes zīme (skat. 34. lpp.)





Sigurnosne napomene

-  Prilikom montaže se radi sprečavanja prignječenja i posekotina moraju nositi rukavice.
-  Proizvod sme da se koristi samo za kupanje, tuširanje i ličnu higijenu.
-  Velika razlika u pritisku između vruće i hladne vode mora biti izbalansirana.
-  Mora se izbegavati kontakt mlaza iz tuša sa osetljivim delovima tela (npr. očima). Telo korisnika mora biti na dovoljnom odstojanju od tuša.
-  Proizvod se ne sme koristiti za kao ručka za pridržavanje. U tu svrhu se mora postaviti zaseban rukohvat.

Instrukcije za montažu

- Armatura mora biti postavljena, isprana i testirana prema važećim normama.
- Obavezno ugradite mrežicu upakovanu s tušem, čime sprečavate ulazak prljavštine iz vodovoda. Prljavština može dovesti do delimičnog ili potpunog oštećenja delova tuša. Za eventualna oštećenja uzrokovana prljavštinom proizvođač Hansgrohe nije odgovoran.

Tehnički podaci

Radni pritisak:	maks. 1 MPa
Preporučeni radni pritisak:	0,1 - 0,5 MPa
Probni pritisak:	1,6 MPa
(1 MPa = 10 bar = 147 PSI)	
Temperatura vruće vode:	maks. 80 °C
Preporučena temperatura vruće vode:	65 °C
Priključci G 1/2:	hladna voda desno - topla levo

Zaštita od povratnog toka

Opis simbola



Održavanje Nepovratni ventil
(vidi stranu 38)

Ispravno funkcionisanje nepovratnog ventila se mora redovno proveravati prema standardu DIN EN 1717 i u skladu s važećim nacionalnim ili regionalnim propisima (najmanje jednom godišnje).

Održavanje Secuflex crevo
(vidi stranu 38)

Ukoliko nakon nekog vremena voda i dalje slabo ističe, ponovite čišćenje.

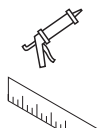

Nemojte koristiti silikon koji sadrži sirćetnu kiselinu!

Mere (vidi stranu 35)



Dijagram protoka
(vidi stranu 35)

- ① Ručni tuš
- ② Dotok kade



Rezervni delovi (vidi stranu 37)

XXX = Oznake boja

000 = hrom
090 = dezen hrom/zlatna



Rukovanje (vidi stranu 36)



Čišćenje (vidi stranu 40)

i priložena brošura



Ispitni znak (vidi stranu 34)



Montaža vidi stranu 31



Sikkerhetshenvisninger

- ⚠ Bruk hansker under montasjen for å unngå klem- og kuttskader.
- ⚠ Dusjsystemet skal kun brukes for bade-, hygiene- og kroppshygiene.
- ⚠ Store trykkdifferanser mellom kaldt- og varmtvannstilkoblinger skal utlignes.
- ⚠ Dusjstrålen skal ikke komme i kontakt med ømfintlige kroppsdeler (f.eks. øynene). Overhold en tilstrekkelig avstand mellom dusjen og kroppen.
- ⚠ Produktet skal ikke brukes som holdegrep. Det skal monteres en separat holdegrep.

Montagehenvisninger

- Armaturen skal monteres, spyles og sjekkes iht. gyldige standarder.
- Silpakningen som er levert med dusjen skal bygges inn for å forhindre at smuss spyles inn fra ledningsnettet. Innspylt smuss kan påvirke funksjonen negativt og/eller kan medføre skader på hånddusjens funksjonsdeler. Hansgrohe påtar seg inget ansvar for skader som resulteres av dette.

Tekniske data

Driftstrykk	maks. 1 MPa
Anbefalt driftstrykk:	0,1 - 0,5 MPa
Prøvetrykk	1,6 MPa
(1 MPa = 10 bar = 147 PSI)	
Varmtvannstemperatur	maks. 80 °C
Anbefalt temperatur for varmt vann	65 °C
Tilkoblinger G 1/2:	kaldt høyre - varm venstre
Egensikker mot tilbakeflyt	

Symbolbeskrivelse



Vedlikehold Returløpssperre (se side 38)

Funksjonen til returløpssperren skal iht. DIN EN 1717 og i samsvar med de nasjonale og lokale forskrifter sjekkes regelmessig (DIN 1988 en gang i året).

Vedlikehold Secuflex slange (se side 38)

Gjenta rengjøringen hvis det er vanskelig å ta ut uttrekkeren .



Ikke bruk silikon som inneholder eddiksyre!



Mål (se side 35)



Gjennomstrømningsdiagram (se side 35)

- ① Hånddusj
- ② Innløp badekar



Serviceledere (se side 37)

XXX = Oznake boja

000 = hrom
090 = dezen hrom/zlatna



Betjening (se side 36)



Rengjøring (se side 40)

og vedlagt brosjyre



Prøvermerke (se side 34)



Montasje se side 31



Указания за безопасност

- ⚠ При монтажа трябва да се носят ръкавици, за да се избегнат наранявания поради притискане или порязване.
- ⚠ Позволено е използването на продукта само за къпане, хигиена и цели на почистване на тялото.
- ⚠ Големите разлики в налягането между изводите за студената и топлата вода трябва да се изравняват.
- ⚠ Трябва да се избягва контакта на струите на разпръсквателя с чувствителни части на тялото (напр. очите). Между разпръсквателя и тялото трябва да се спазва достатъчно разстояние.
- ⚠ Продуктът не бива да се използва като дръжка. Трябва да се монтира отделна дръжка.

Указания за монтаж

- Арматурата трябва да се монтира, промие и провери в съответствие с валидните норми.
- Опакованото заедно с разпръсквателя уплътнение с цедка трябва да се монтира, за да се избегне натрупване на замърсявания от водопроводната мрежа. Натрупването на замърсявания може да наруши функцията и/или да доведе до увреждания на функционалните части на разпръсквателя, Hansgrohe не носи отговорност за получените се по този начин щети.

Технически данни

Работно налягане:	макс. 1 МПа
Препоръчително работно налягане:	0,1 – 0,5 МПа
Контролно налягане:	1,6 МПа
(1 МПа = 10 bar = 147 PSI)	
Температура на горещата вода:	макс. 80 °C
Препоръчителна температура на горещата вода:	65 °C
Изводи G 1/2:	студено отцясно – топло отляво
Самозащитен против обратно изтичане	

Описание на символите



Поддръжка Приспособление, предотвратяващо обратния поток (вижте стр. 38)

Съгласно DIN EN 1717 функционирането на приспособленията за предотвратяване на обратния поток трябва редовно да се проверява в съответствие с националните или регионални изисквания (поне веднъж годишно).

Поддръжка Маркуч Secuflex (вижте стр. 38)

Повторете почистването, ако в течение на времето изтеглящата се част стане трудно подвижна.

Не използвайте силикон, съдържащ оцетна киселина!

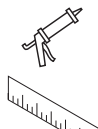

Размери (вижте стр. 35)

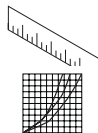

Диаграма на потока (вижте стр. 35)

- ① Ръчен разпръсквател
- ② Вход за вана



Сервизни части (вижте стр. 37)

XXX = Označe boja

000 = hrom

090 = dezen hrom/zlatna

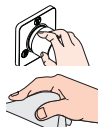

Обслужване (вижте стр. 36)

Почистване (вижте стр. 40)

и приложена брошура







Контролен знак (вижте стр. 34)



Монтаж вижте стр. 31



Udhëzime sigurie

-  Për të evituar lëndimet e pickimeve ose të prerjeve gjatë procesit të montimit duhet që të vishni doreza.
-  Produkti duhet të përdoret vetëm qëllimet e banjavë, të higjienës dhe të larjes së trupit.
-  Ndryshimet e mëdha të presionit mes lidhjeve të ujit të ftohtë dhe atij të ngrohtë duhen ekuilibruar.
-  Kontakti i valëve të dushit me pjesët e ndjeshme të trupit (p.sh. me sytë) duhet që të shmanget. Midis dushit dhe trupit duhet që të mbahet një distancë e mjaftueshme.
-  Produkti nuk duhet të përdoret si dorëze mbajtëse. Duhet të montohet një dorëzë mbajtëse e veçantë

Udhëzime për montimin

- Armatura duhet montuar, shpërlarë dhe kontrolluar në bazë të normave të vlefshme.
- Sita që i kemi bashkëngjitur spërkatëses duhet përdorur për të evituar thithjen e papastërtive nga rrjeti i ujës-jellësit. Ndotjet mund të dëmtojnë pjesë funksionale të spërkatëses. Hansgrohe nuk merr përgjegjësinë për dëmet e shkaktuara në këtë mënyrë.

Të dhëna teknike

Presioni gjatë punës	maks. 1 MPa
Presioni i rekomanduar:	0,1 - 0,5 MPa
Presioni për provë:	1,6 MPa
(1 MPa = 10 bar = 147 PSI)	
Temperatura e ujit të ngrohtë	maks. 80 °C
Temperatura e rekomanduar e ujit të ngrohtë:	65 °C
Lidhjet G 1/2:	i ftohtë djathtas / i ngrohtë majtas

Siguresa kundër rrjedhjes në drejtim të kundërt

Përshkrimi i simbolit



Mirëmbajtja Penguesi i rrjedhjes në drejtim të kundërt
(shih faqen 38)

Penguesit e rrjedhjes në drejtim të kundërt duhen kontrolluar rregullisht në bazë të normave DIN EN 1717 konform normave nacionale dhe regionale (së paku një herë në vit).

Mirëmbajtja Zorra Secuflex
(shih faqen 38)

Përsërisni pastrimin nëse me kalimin e kohës vështrësohet nxjerrja e dorëzës së zgjatur.

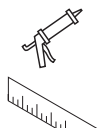

Mos përdorni silikon që në përbërje ka acid acetik.

Përmasat (shih faqen 35)



Diagrami i qarkullimit
(shih faqen 35)

- ① Spërkatësja e dorës
- ② Vrima për mbushjen e vaskës



Pjesë ndërrimi (shih faqen 37)

XXX = Oznake boja

000 = hrom
090 = dezen hrom/zlatna



Përdorimi (shih faqen 36)



Pastrimi (shih faqen 40)

dhe broshura bashkëngjitur



Shenja e kontrollit
(shih faqen 34)





وصف الرمز

الصيانة صمام عدم الرجوع
(راجع صفحة 38)



يجب فحص صمام عدم الرجوع بصفة منتظمة حسب المواصفة DIN EN 1717 وذلك طبقاً للوائح الوطن أو الإقليمية (مرة واحد سنوياً على الأقل).

الصيانة خرطوم Secuflex
(راجع صفحة 38)

كرر التنظيف كلما تعذر خروج الماء.

تنبيهات الأمان



يجب إرتداء قفازات لليد أثناء التركيب لتجنب حدوث أخطار الإلتهاب أو الجروح.

لا يجب استخدام نظام الدش إلا في أعراض الاستحمام والأعراض الصحية وأعراض تنظيف الجسم.

يجب أن يكون تيار الماء الساخن والماء البارد متعادلين في الضغط.

يجب تجنب حدوث إتصال مباشر بين الماء الخارج من رأس الدش وبين أجزاء الجسم الحساسة (مثل العينين). يجب وجود مسافة كافية بين رأس الدش والجسم.

ممنوع إستخدام المنتج كمقبض. يجب تركيب مقبض منفصل.

تعليمات التركيب

• يجب تركيب الوصلة واستخدامها واختبارها وفقاً للمعايير المعمول بها.

• يجب إدخال الحلقة الشبكية لحماية الدش اليدوي من الأوساخ التي تحملها شبكة المواسير. حيث تؤدي الأوساخ الواردة إلى حدوث أعطال أو / و قد تتسبب في تلف أجزاء من من الدش، ومثل هذه الأعطال تلغي كافة المطالبات الخاصة بالمسؤولية أو الضمان.

هام! لا تستخدم السليكون الذي يحتوي على أحماض!

أبعاد (راجع صفحة 35)



رسم للصراف

(راجع صفحة 35)

① الدش اليدوي

② مدخل مياه للبانويو

قطع الغيار (راجع صفحة 37)

XXX = الألوان

000 = كروم

090 = كروم/لون ذهبي



المواصفات الفنية

ضغط التشغيل:

ضغط التشغيل الموصى به:

ضغط الاختبار:

(1 ميغاباسكال = 10 بار = 147 PSI)

درجة حرارة الماء الساخن:

درجة الحرارة الموصى بها للماء الساخن:

الوصلات G 1/2 :

-

اليسار

خاصة عدم التدفق، العكس،

التشغيل (راجع صفحة 36)



التنظيف (راجع صفحة 40)

والكتيب المرفق



شهادة اختبار (راجع صفحة 34)





13444180

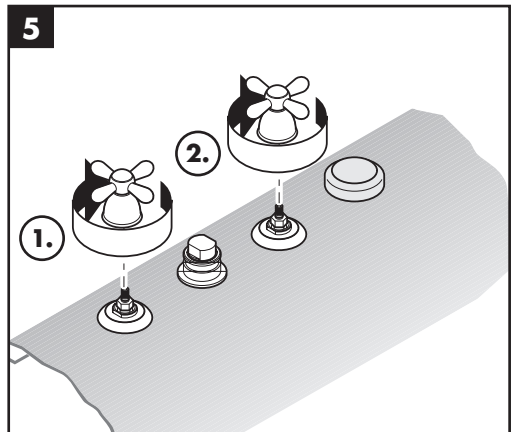
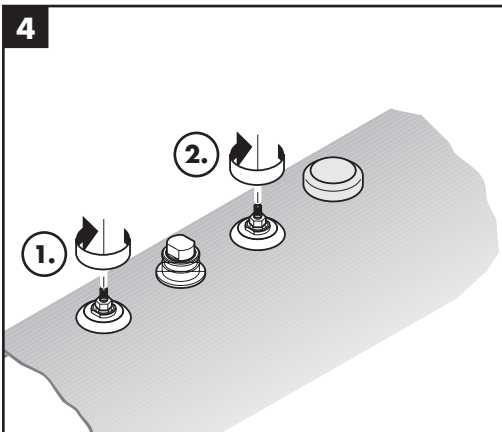
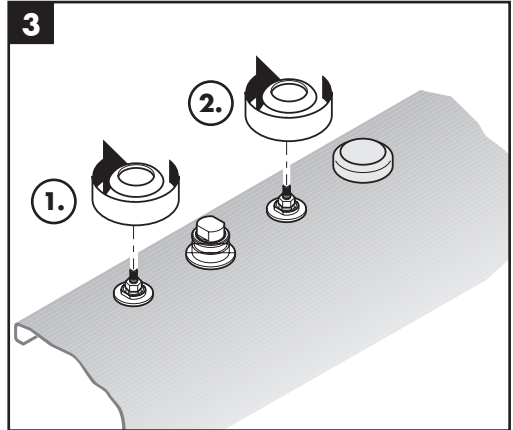
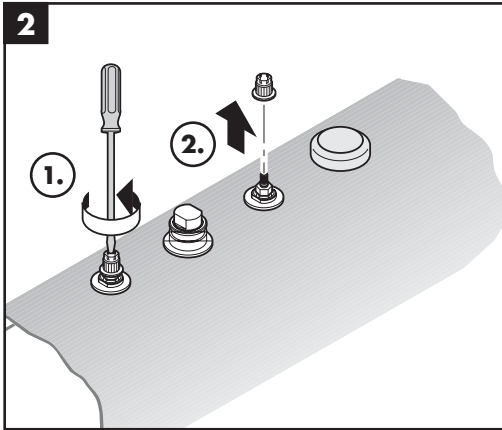
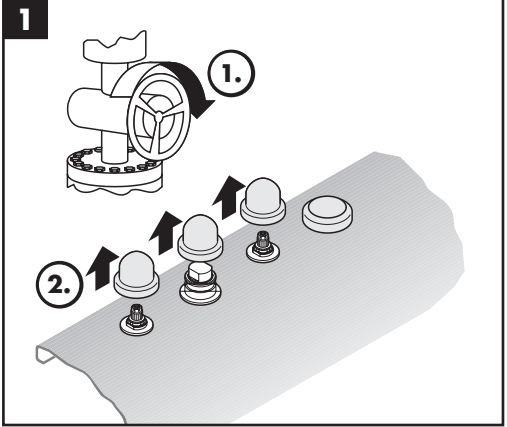
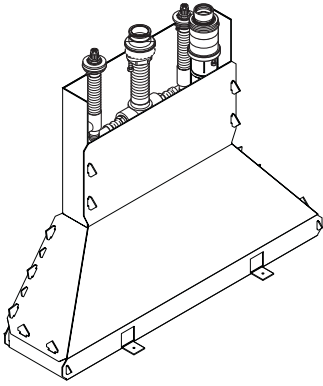

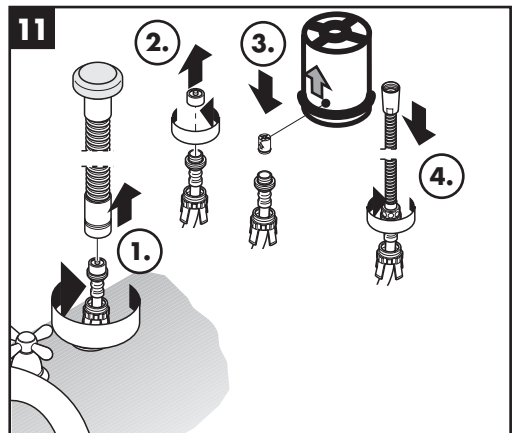
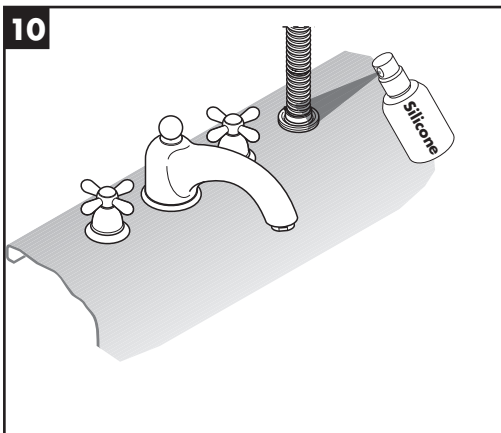
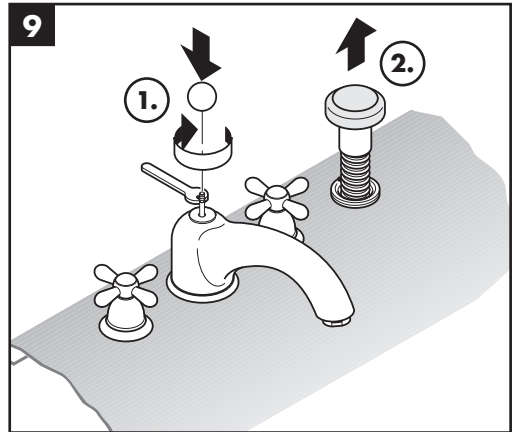
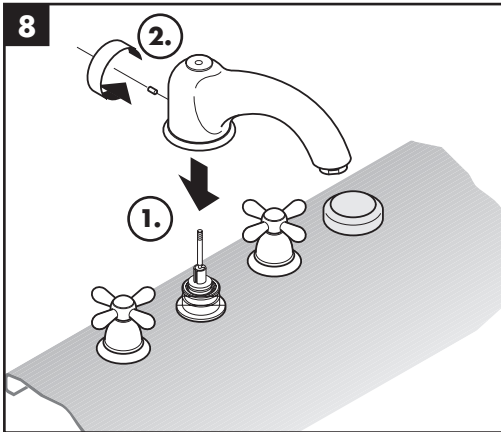
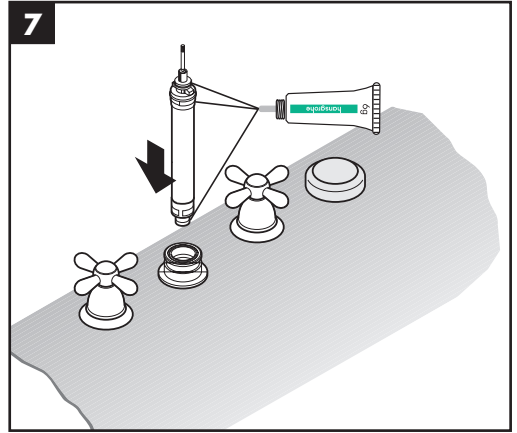
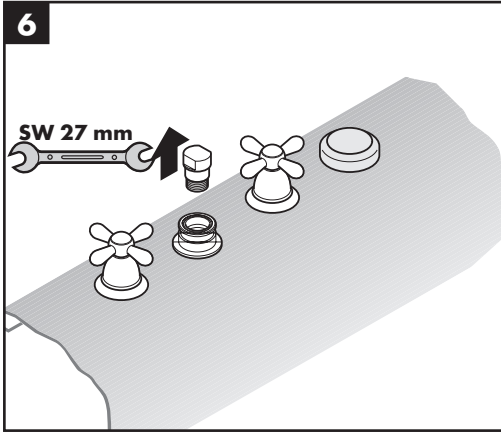

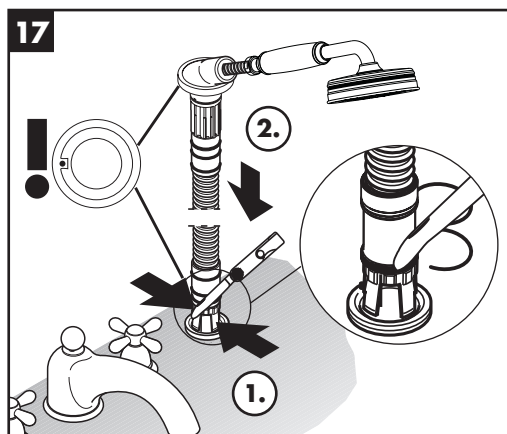
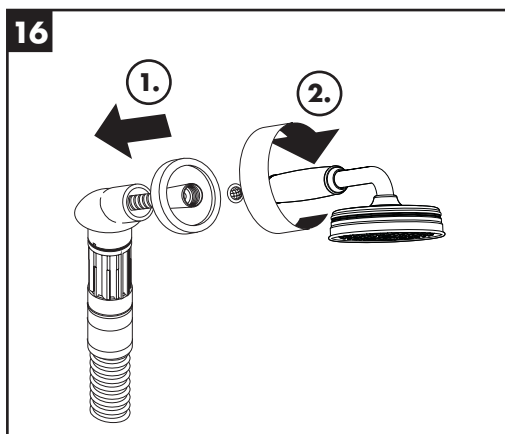
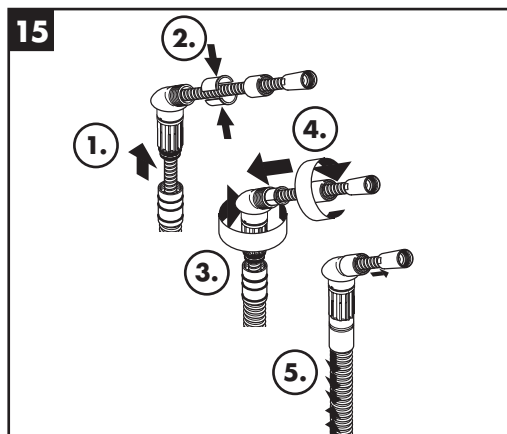
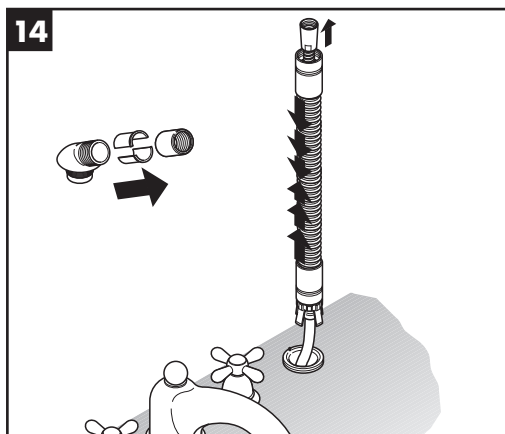
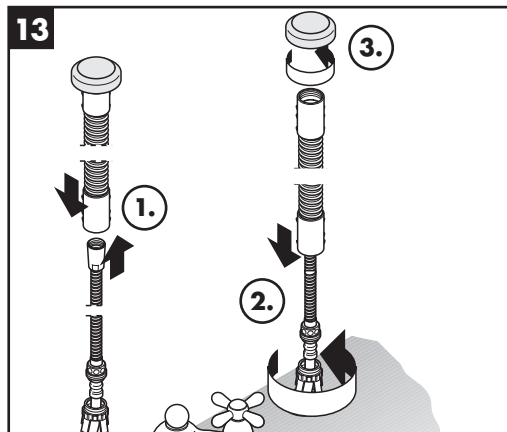
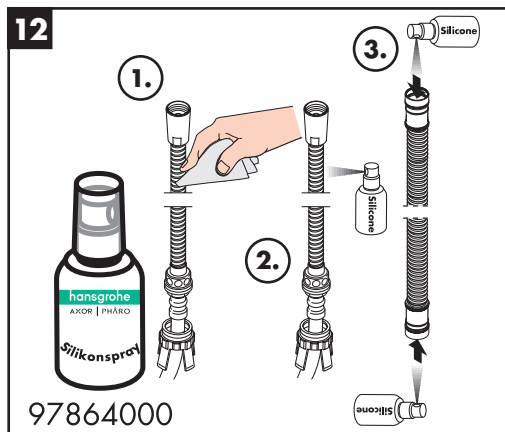



18

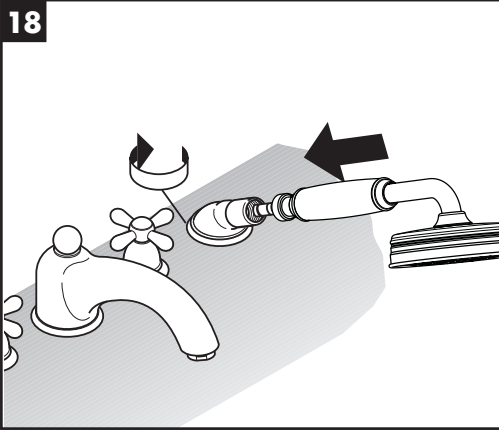

P-IX

DVGW

SVGW

ACS

WRAS

MCA

KIWA

17444000 P-IX 9087/ICB



Carlton 17444XXX

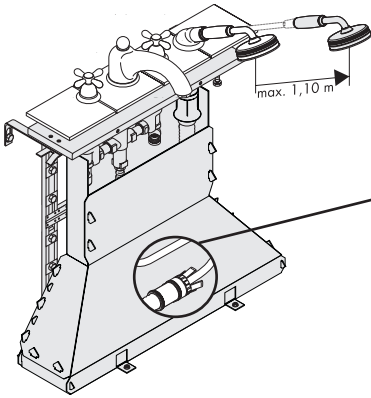
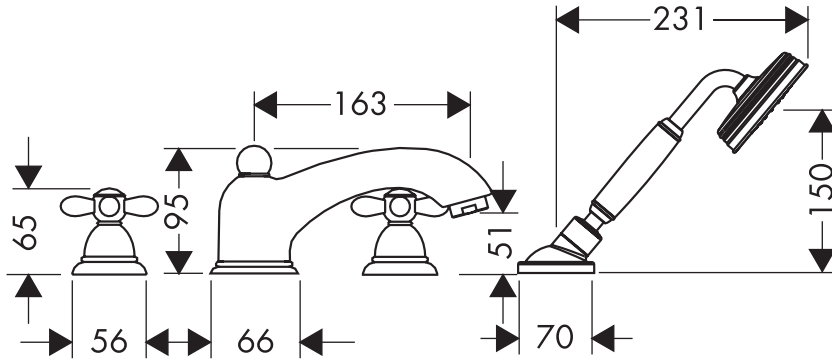

DIN-DVGW

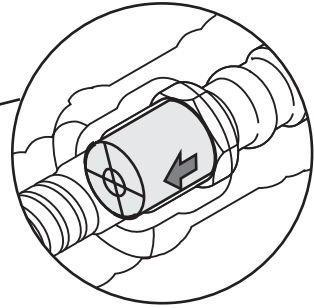

Carlton 17444XXX

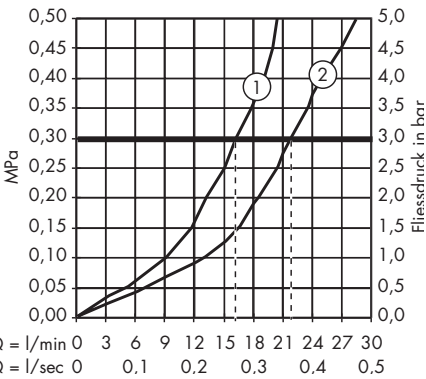

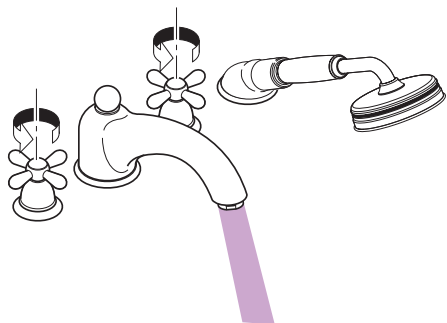

öffnen / ouvert / open / aperto / abierto / open / åbne /
 abrir / otworzyć / otevřít / otvorit / 开 / открыть / nyitás /
 avaaaminen / öppna / atidaryti / Отвараніе / açmak /
 deschide / ανοικτό / odpreti / avage / atvērt /
 otvoriti / åpne / отварање / hare / فتح

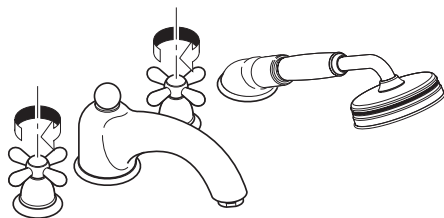

schließen / fermé / close / chiudere / cerrar / sluiten /
 lukke / fechar / zamknąć / zavřít / uzavriť / 关 /
 закрыть / bezárás / sulkeminen / stänga / uždaryti /
 Zatvaranje / kapatmak / închide / κλειστό /
 zapreti / sulgege / aizvērt / zatvori / lukke / затваряње /
 mbylle / إغلاق

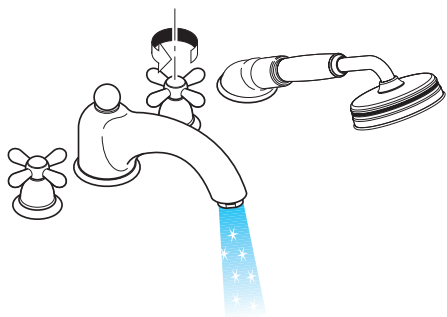

kalt / froid / cold / freddo / frío / koud / koldt / fria /
 zimna / studená / studená / 冷 / холодная / hideg /
 kylmä / kallt / šaltas / Hladno / soğuk / rece / криво /
 mrzlo / külm / auksts / hladno / kaldt / студено / i ftohtë /
 بارد

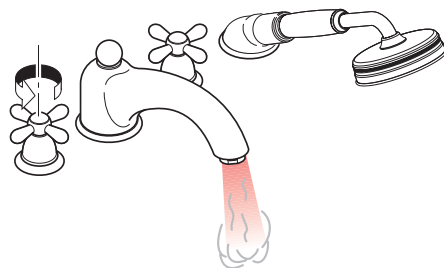

warm / chaud / hot / caldo / caliente / warm / varmt /
 quente / ciepła / teplá / teplá / 热 / горячая / meleg /
 lämmin / varmt / karštas / Vruća voda / sıcak / cald /
 ζεστό / toplo / kuum / karsts / topla / varm / топло /
 i ngròhtë / ساخن

