

Montageanleitung

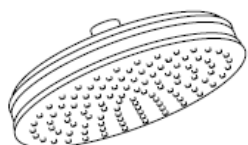

Carlton/Montreux
28474XXX/28487XXX

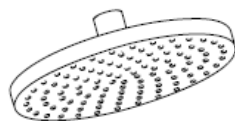

Terrano
28484XXX/28485XXX

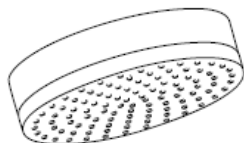

Citterio
28489000

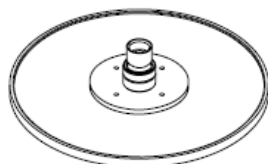

**Starck/Steel/Uno
Air**
28494XXX

AXOR[®]

hansgrohe

Hansgrohe Brausen können in Verbindung mit hydraulisch und thermisch gesteuerten Durchlauferhitzern eingesetzt werden, wenn der Fließdruck vor der Armatur mindestens 0,15 MPa beträgt.

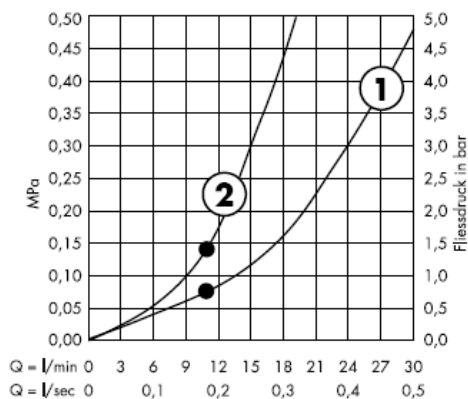

Ab • ist die Funktion gewährleistet.

① Normalstrahl

Carlton / Montreux
28474XXX

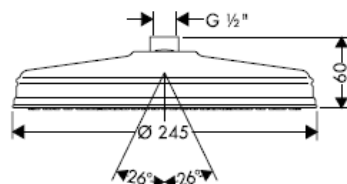

② Normalstrahl + Waterdimmer®
(Durchflussbegrenzer)

Carlton / Montreux
28487XXX

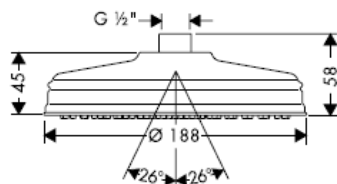

Citterio
28489000

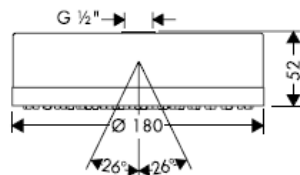

Montage

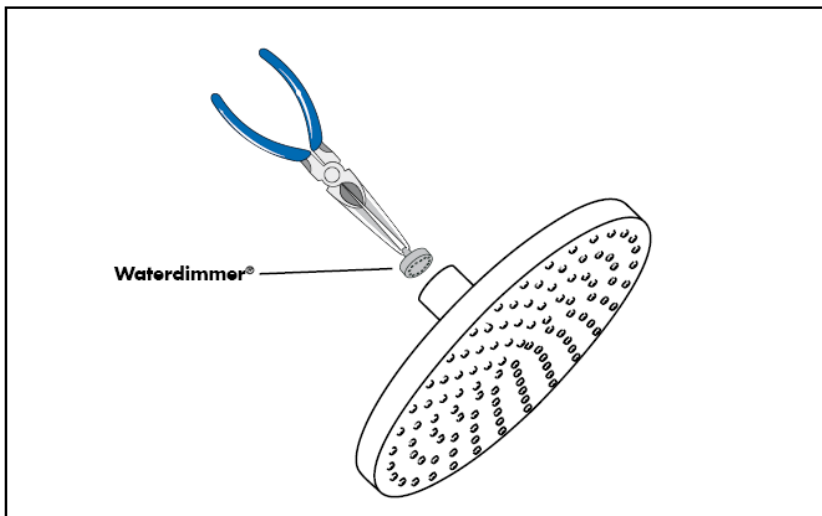
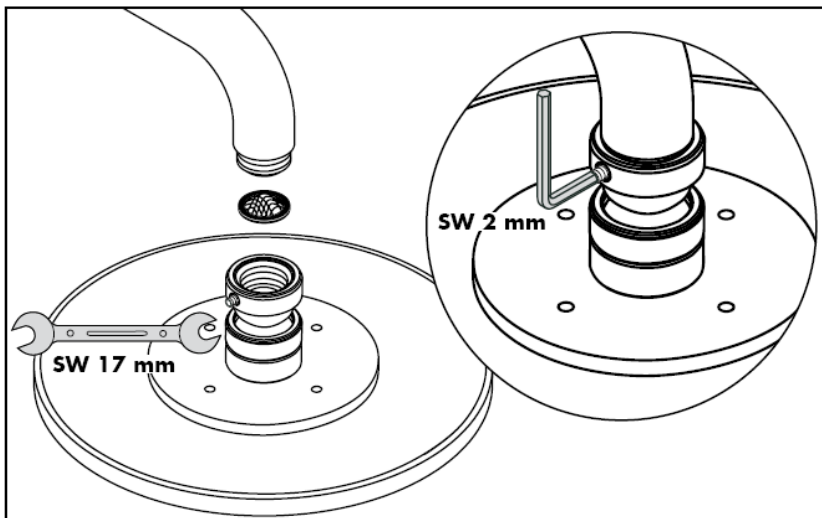

Die der Brause beige packte Siebdichtung muss eingebaut werden, um Schmutzeinspülungen aus dem Leitungsnetz zu vermeiden. Schmutzeinspülungen können die Funktion beeinträchtigen und/oder zu Beschädigungen an Funktionsteilen der Brause führen, für hieraus ergebende Schäden haftet Hansgrohe nicht.

Terrano
28484XXX

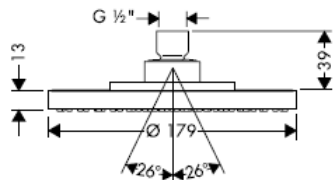

Terrano
28485XXX

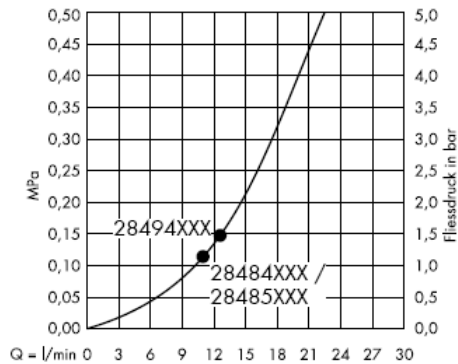
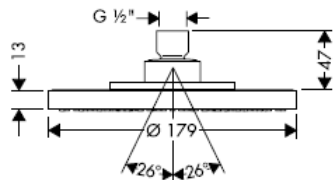

Ab • ist die Funktion gewährleistet.

Starck/Steel/Uno Air
28494XXX

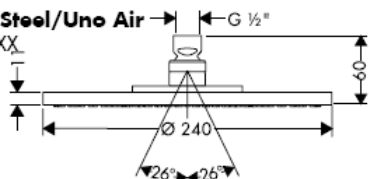

Montage

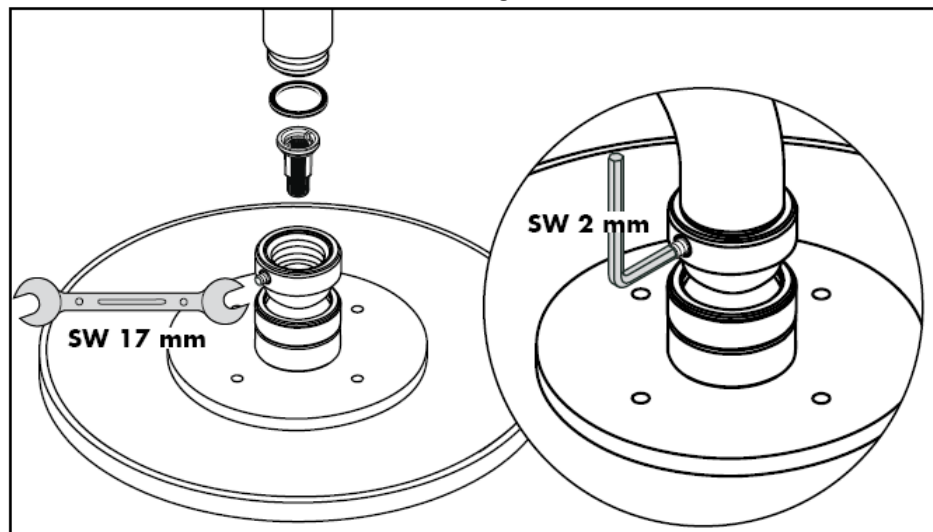

Der beige packte Filtereinsatz muss eingebaut werden, um Schmutzeinspülungen aus dem Leitungsnetz zu vermeiden.

Schmutzeinspülungen können die Funktion beeinträchtigen und/oder zu Beschädigungen an Funktionsteilen der Brause führen, für hieraus ergebende Schäden haftet Hansgrohe nicht.

Reinigung

Mit Rubit®, der manuellen Reinigungsfunktion können die Strahlformer durch einfaches rubbeln vom Kalk befreit werden.

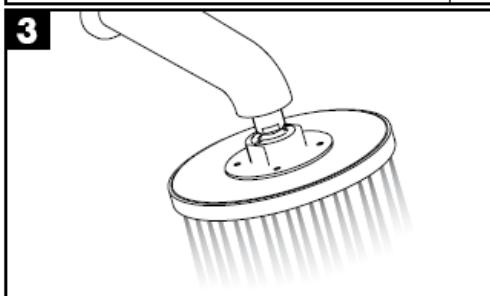
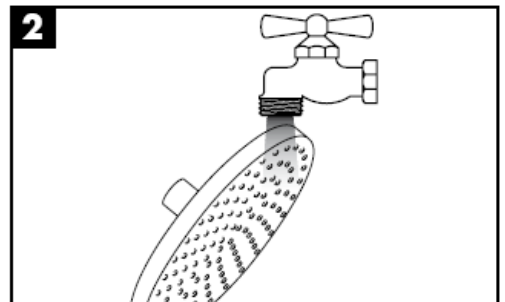
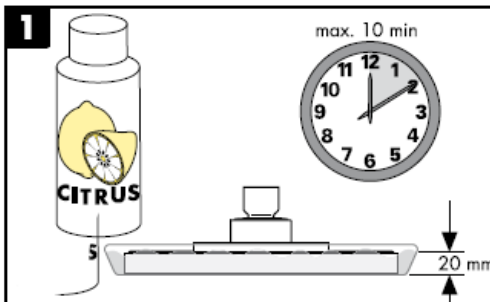
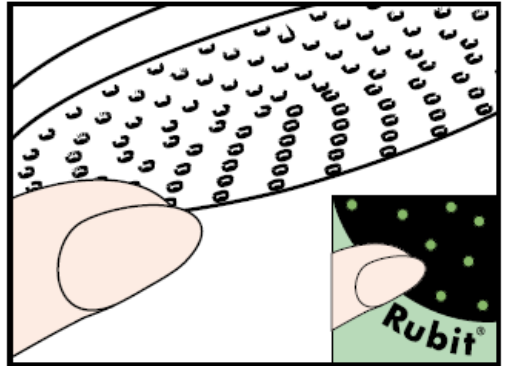

hansgrohe

Instructions de montage

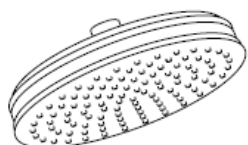

Carlton/Montreux
28474XXX/28487XXX

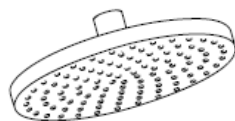

Terrano
28484XXX/28485XXX

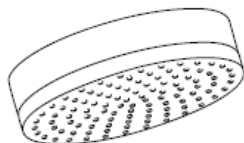

Citterio
28489000

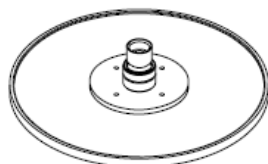

**Starck/Steel/Uno
Air**
28494XXX

AXOR[®]

hansgrohe

Les douchettes de Hansgrohe peuvent être utilisées en liaison avec des chauffe-eau hydrauliques et à commande thermique, lorsque la pression présente en amont de la robinetterie est d'au moins 0,15 MPa

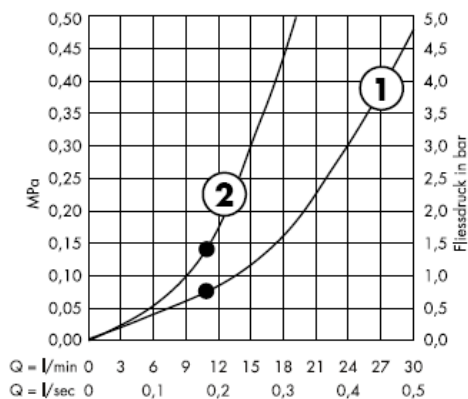

A partir de • le fonctionnement est garanti.

① Jet de pluie

Carlton / Montreux
28474XXX

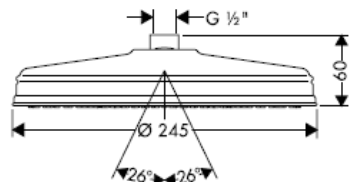

② Jet de pluie + Limiteur de débit

Carlton / Montreux
28487XXX

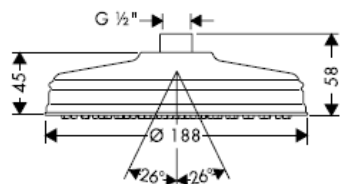

Citterio
28489000

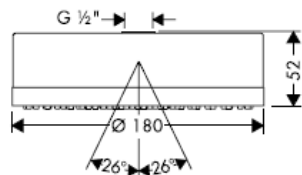

Montage

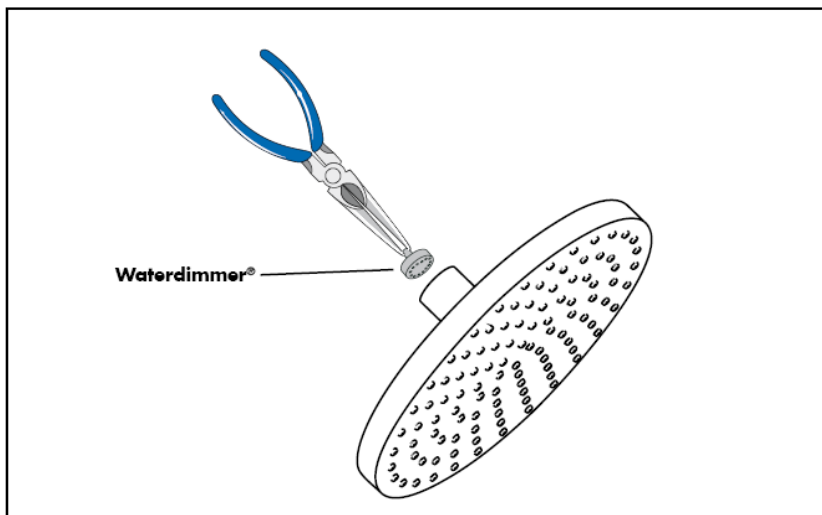
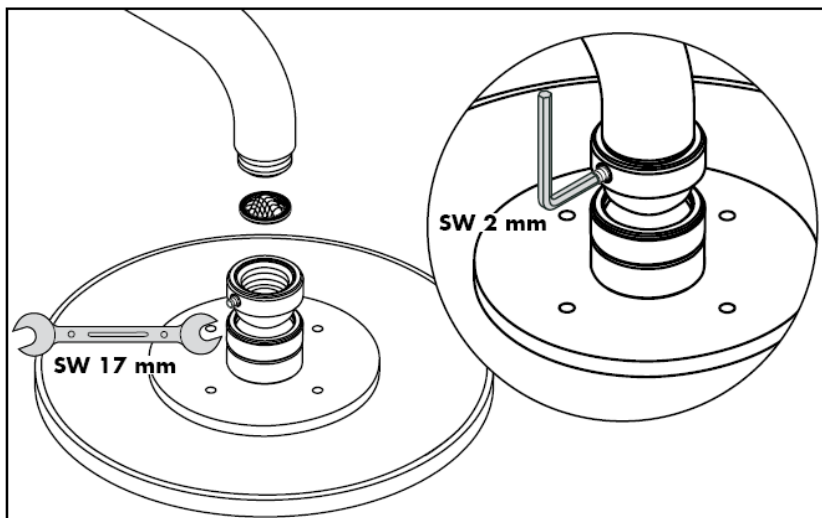

Le joint à filtre fourni avec la pomme de douche à main doit être installé afin de retenir des impuretés du système de conduites. Ceux-ci pourraient influencer le fonctionnement de ce produit et même endommager des pièces mobiles. Des réclamations à la suite de l'usage de la pomme de douche sans joint-tamis de hansgrohe ne peuvent pas faire partie de notre garantie.

Terrano
28484XXX

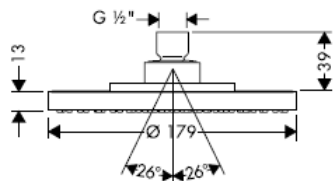

Terrano
28485XXX

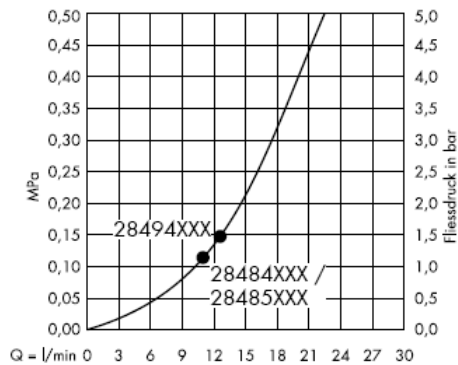
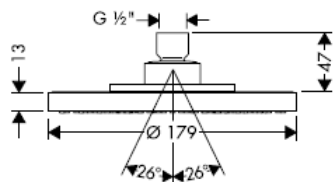

A partir de • le fonctionnement est garanti.

Starck/Steel/Uno Air
28494XXX

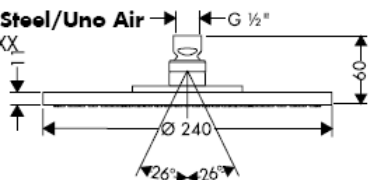

Montage

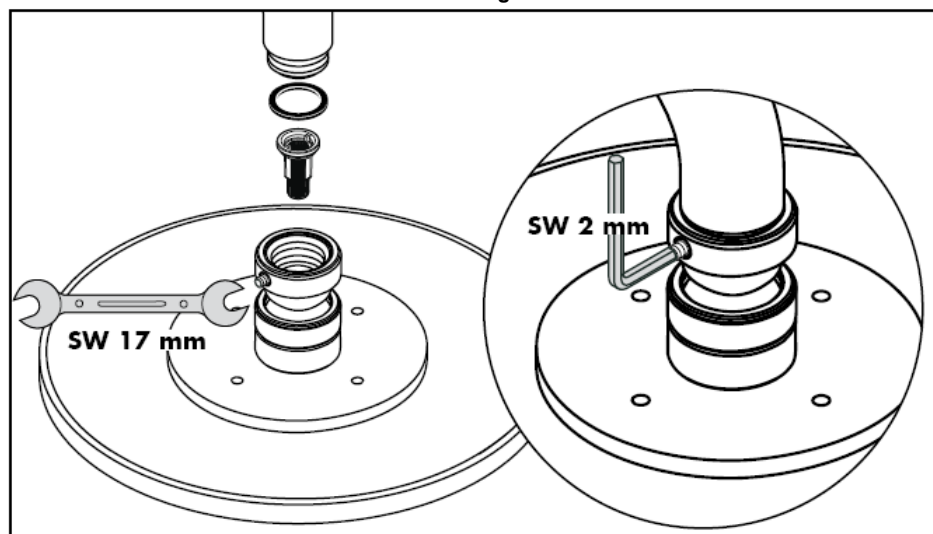

L'élément-filtre, pièce jointe, doit être installé pour éviter l'infiltration d'impuretés venant du réseau. Ceux-ci pourraient influencer le fonctionnement de ce produit et même endommager des pièces mobiles. Des réclamations à la suite de l'usage de la pomme de douche sans joint-tamis de hansgrohe ne peuvent pas faire partie de notre garantie.

Nettoyage

La pomme de douche est équipée de Rubit®, le système anticalcaire manuel. Les dépôts de calcaire s'enlèvent en frottant avec un doigt ou avec une éponge sur les ouvertures de jets élastiques.

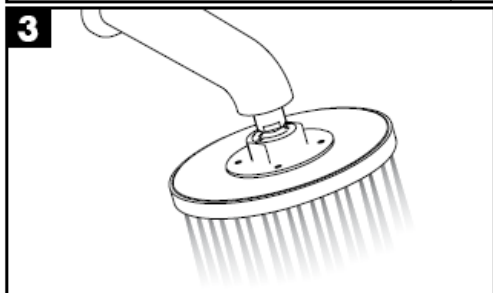
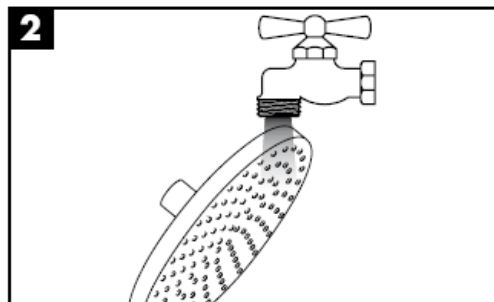
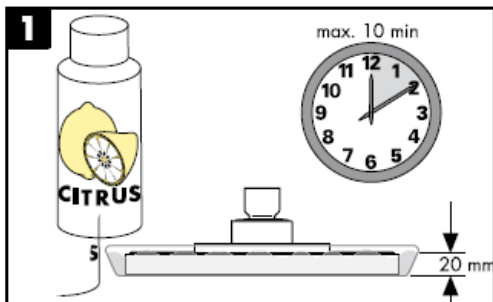
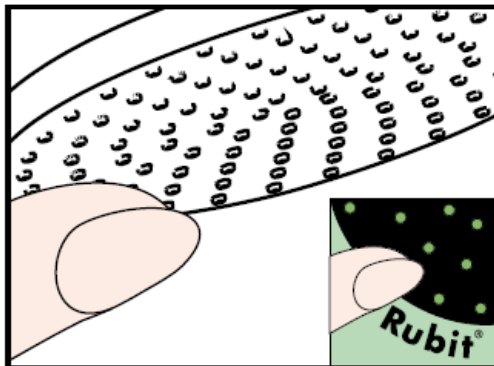

hansgrohe

assembly instructions

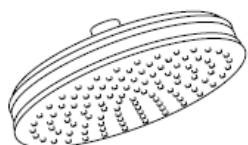

Carlton/Montreux
28474XXX/28487XXX

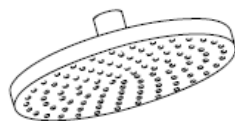

Terrano
28484XXX/28485XXX

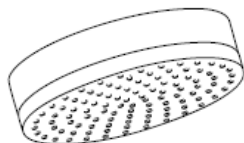

Citterio
28489000

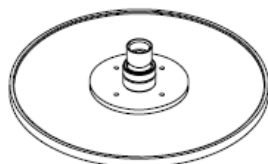

**Starck/Steel/Uno
Air**
28494XXX

AXOR[®]

hansgrohe

Hansgrohe showers can be used together with hydraulically and thermally controlled continuous flow heaters if the flow pressure is at least 0,15 MPa before the shower fitting.

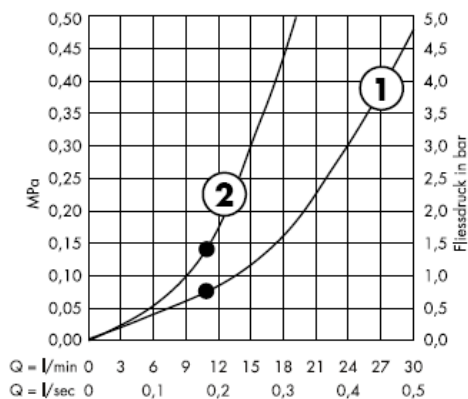

From • the function is guaranteed.

1 Normal spray

Carlton / Montreux
28474XXX

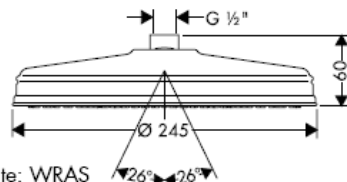

Test certificate: WRAS

2 Normal spray + Flow limiter

Carlton / Montreux
28487XXX

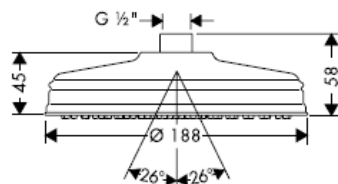

Citterio
28489000

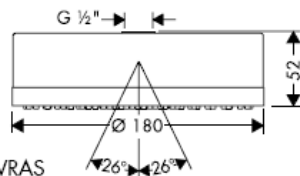

Test certificate: WRAS

Assembly

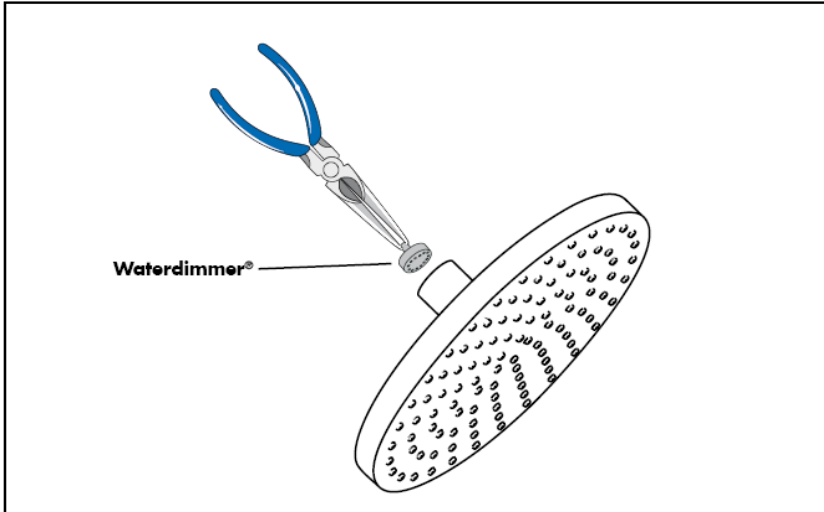
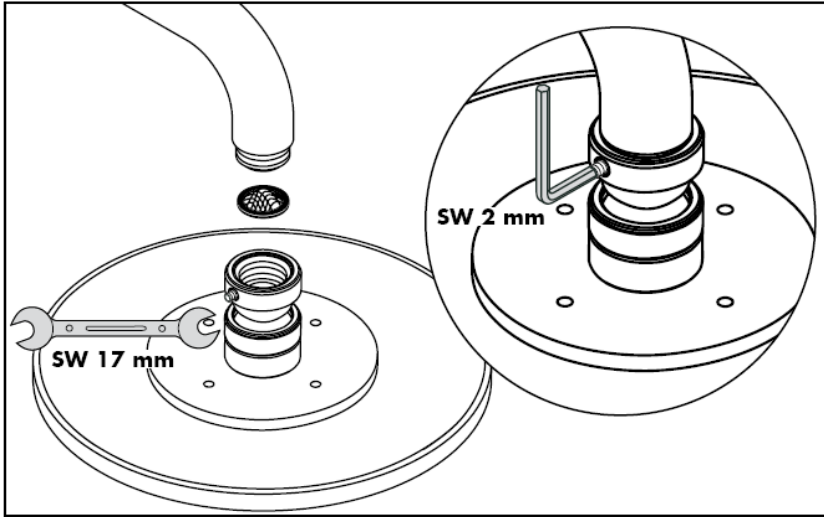

The mesh washer must be inserted to protect the overhead shower against incoming dirt by pipework. Incoming dirt leads to defects or/and can damage parts of the shower; such caused faults voids all liability and guarantee claims.

Terrano
28484XXX

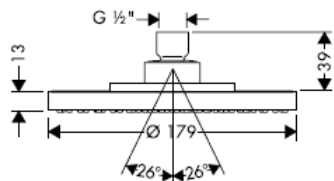

Terrano
28485XXX

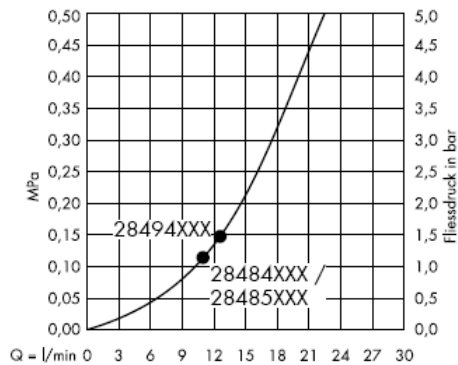
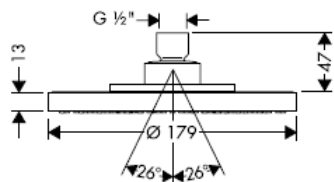

From • the function is guaranteed.

Starck/Steel/Uno Air
28494XXX

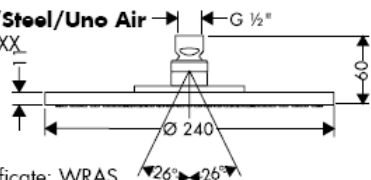

Test certificate: WRAS

Assembly

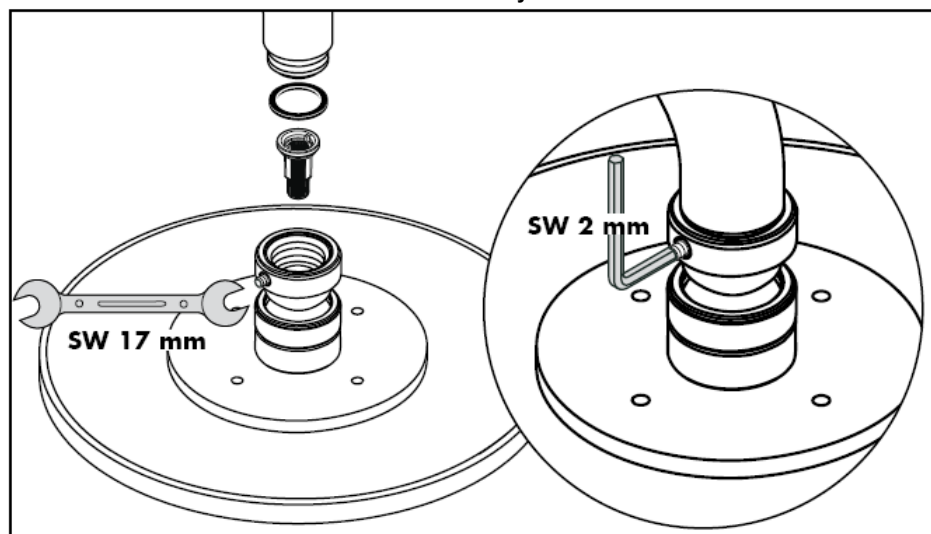

The filter insert must be use to protect the shower against incoming dirt by pipework. Incoming dirt leads to defects or/and can damage parts of the shower; such caused faults voids all liability and guarantee claims.

Cleaning

The Rubit® cleaning function only needs a small manual rub over to remove the lime scale from the spray channels.

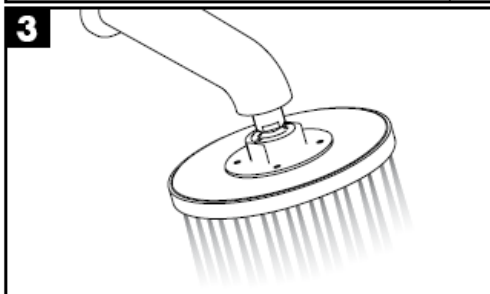
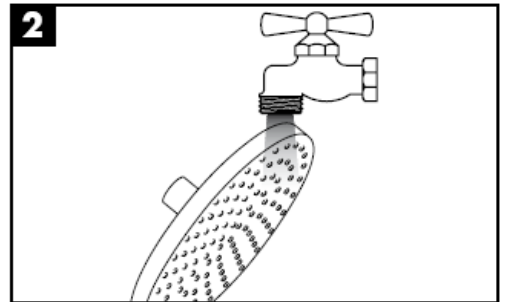
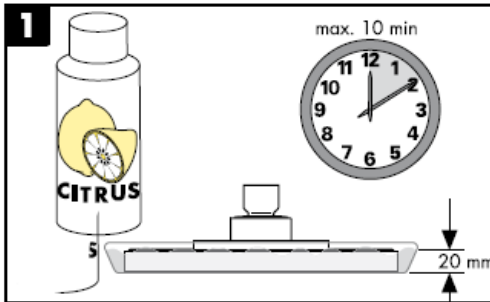
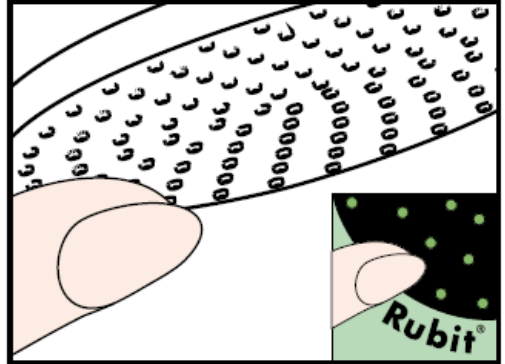

hansgrohe

Istruzioni per Installazione

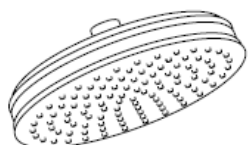

Carlton/Montreux
28474XXX/28487XXX

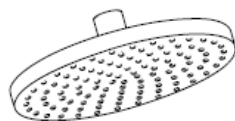

Terrano
28484XXX/28485XXX

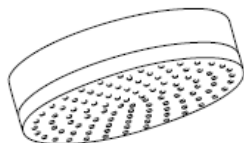

Citterio
28489000

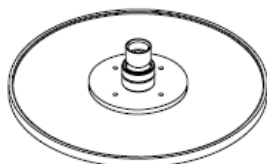

**Starck/Steel/Uno
Air**
28494XXX

AXOR[®]

hansgrohe

Le doccette Hansgrohe possono essere utilizzate in funzione di scaldabagni idraulici e termici, se la pressione di flusso davanti alla rubinetteria è di almeno 0,15 MPa.

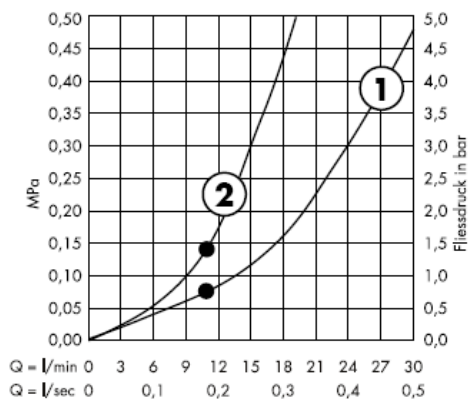

Dal • si garantisce la funzionalità.

1 Getto normale a pioggia

Carlton / Montreux
28474XXX

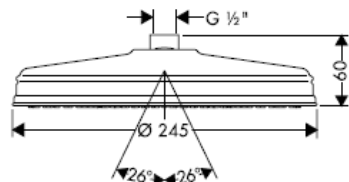

2 Getto normale a pioggia + Riduttore di portata

Carlton / Montreux
28487XXX

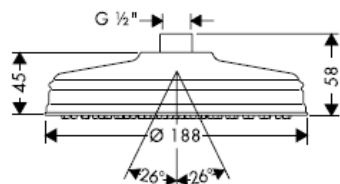

Citterio
28489000

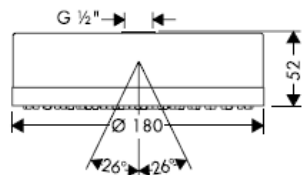

Montaggio

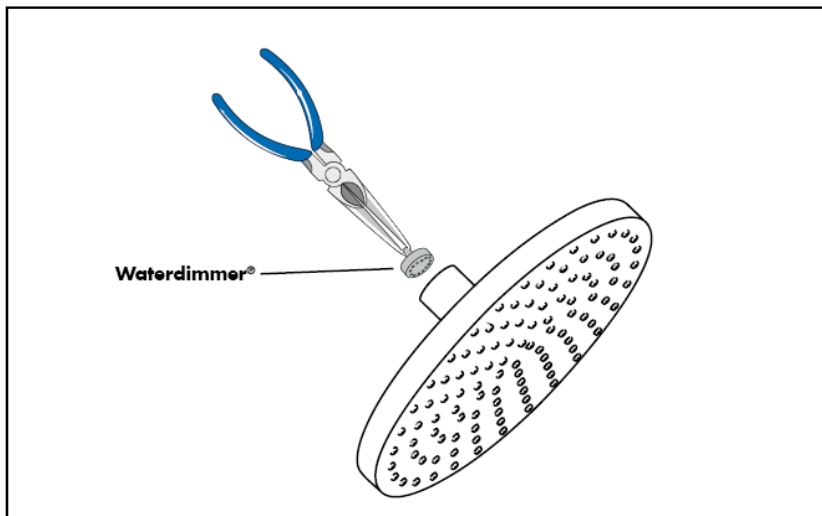
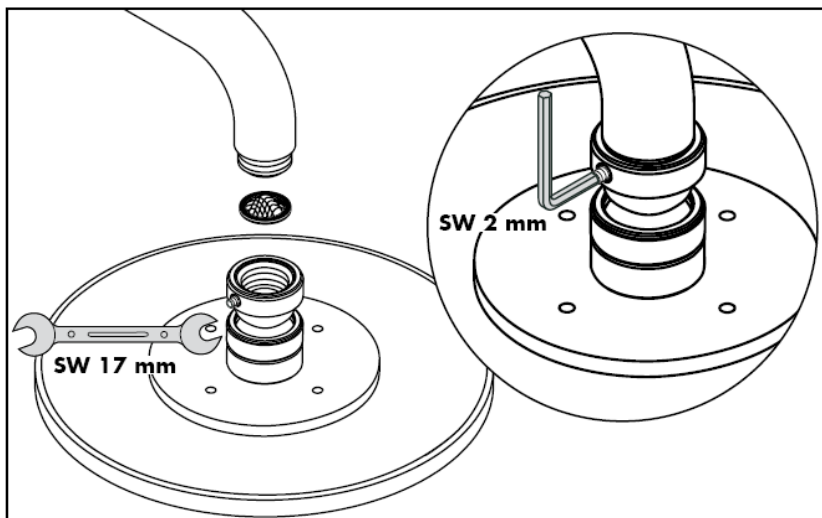

Per proteggere la soffione doccia da eventuali impurità provenienti dalle tubazioni dell'acqua, deve essere inserito il filtro nell'impugnatura della doccia stessa. Tali impurità possono infatti causare difetti e/o danneggiare parti della doccia; in questo caso la Hansgrohe non risponde dei danni.

Terrano
28484XXX

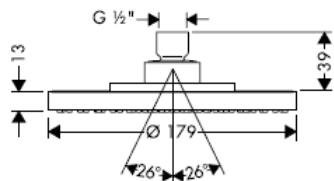

Terrano
28485XXX

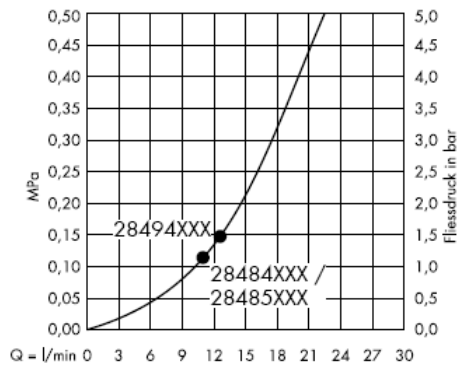
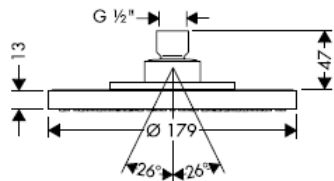

Dal • si garantisce la funzionalità.

Starck/Steel/Uno Air
28494XXX

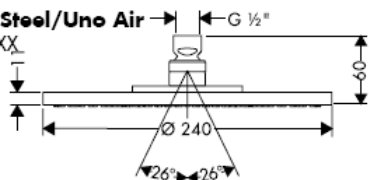

Montaggio

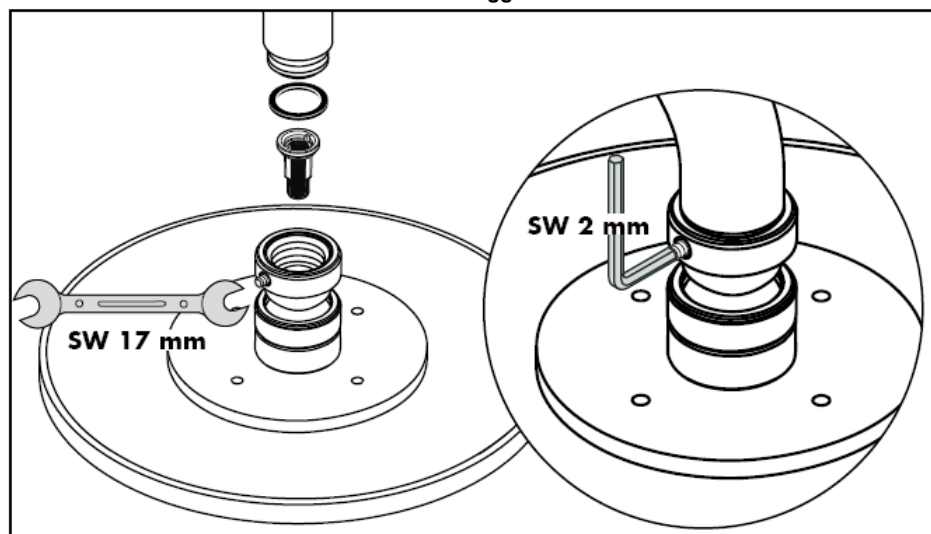

Il filtro supplementare deve essere utilizzato per proteggere la doccia dai depositi di calcare. Tali impurità possono infatti causare difetti e/o danneggiare parti della doccia; in questo caso la Hansgrohe non risponde dei danni.

Pulitura

Con Rubit®, la funzione anticalcare manuale, i diffusori del getto possono essere liberati da calcare con un semplice strofinamento.

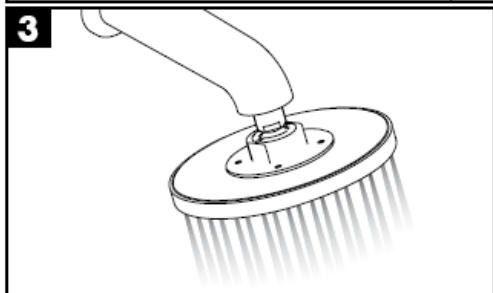
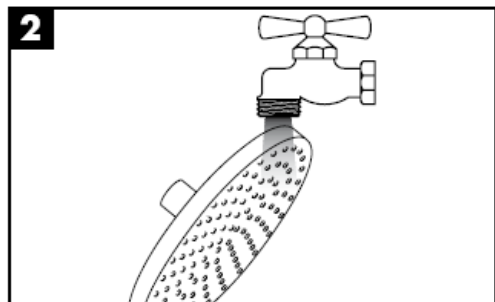
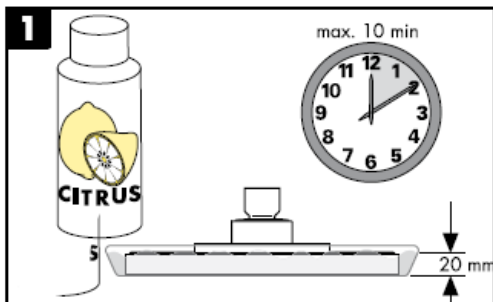
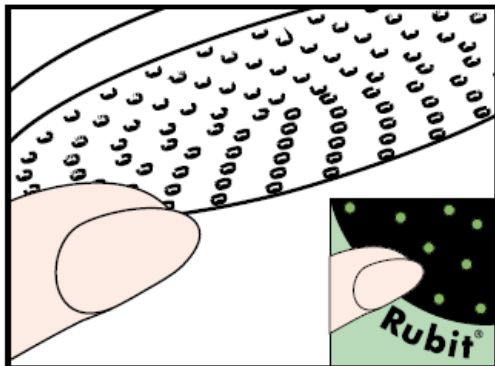

hansgrohe

Instrucciones de montaje

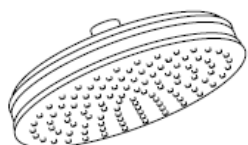

Carlton/Montreux
28474XXX/28487XXX

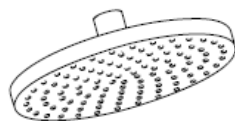

Terrano
28484XXX/28485XXX

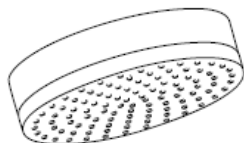

Citterio
28489000

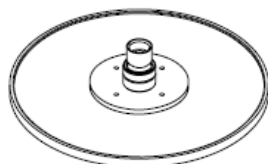

**Starck/Steel/Uno
Air**
28494XXX

AXOR[®]

hansgrohe

Las duchas mural de Hansgrohe se pueden utilizar en combinación con calentadores instantáneos con control hidráulico o térmico siempre que la presión dinámica del agua supere los 0,15 MPa.

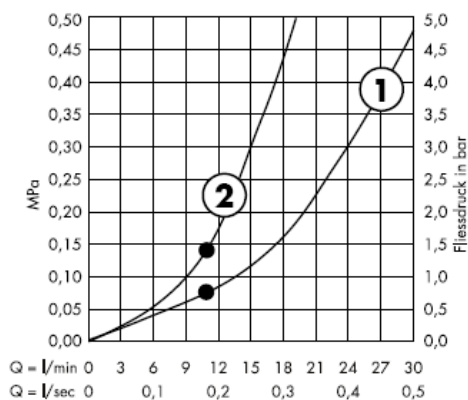

Mínimo • para el correcto funcionamiento.

① Chorro de lluvia

Carlton / Montreux
28474XXX

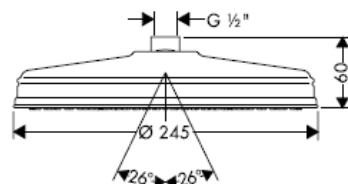

② Chorro de lluvia + Limitador de caudal

Carlton / Montreux
28487XXX

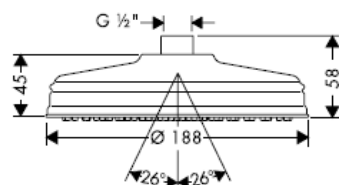

Citterio
28489000

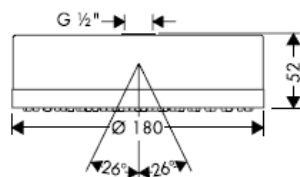

Montaje

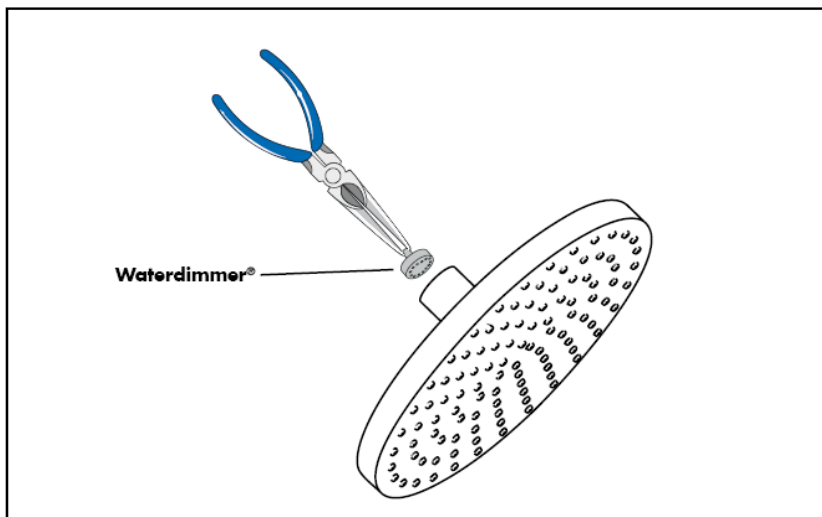
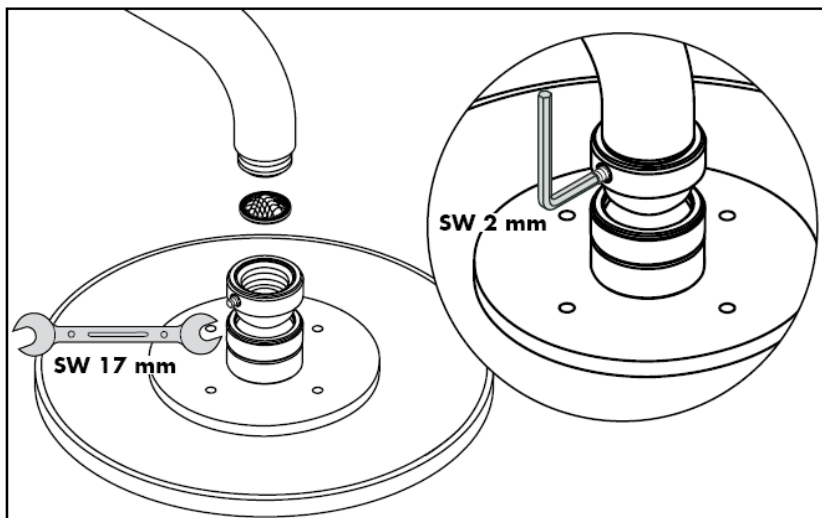

La junta de filtración que se suministra con la ducha mural evita que las partículas de suciedad procedentes de las tuberías lleguen a la ducha mural. Debe colocarse entre el flexo y la ducha mural. Infiltraciones de suciedad deterioran el funcionamiento de la ducha mural y pueden causar daños en el interior de la misma que no están cubiertas por la garantía de Hansgrohe.

Terrano
28484XXX

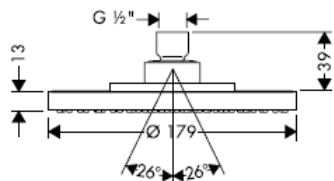

Terrano
28485XXX

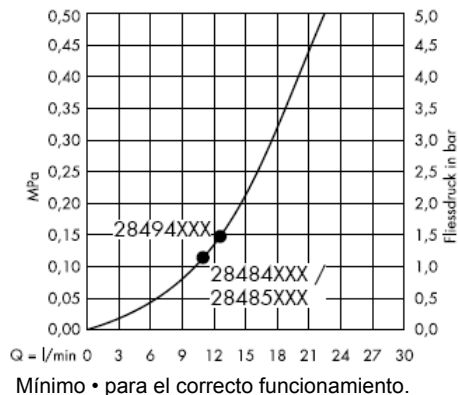
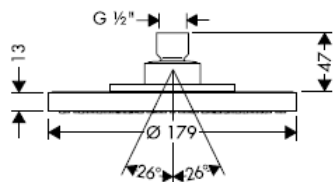

Starck/Steel/Uno Air
28494XXX

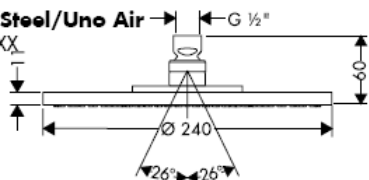

Montaje

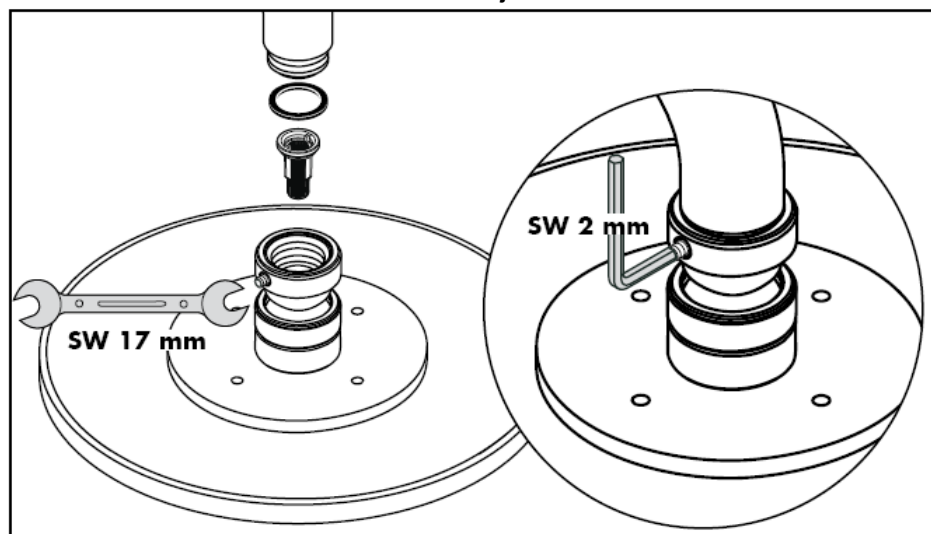

La inserción del filtro debe usarse para proteger la ducha de la suciedad proveniente de las tuberías. Debe colocarse entre el flexo y la ducha mural. Infiltraciones de suciedad deterioran el funcionamiento de la ducha mural y pueden causar daños en el interior de la misma que no están cubiertas por la garantía de Hansgrohe.

Limpiar

Rubit®, la función de limpieza manual, permite quitar la cal simplemente frotando los ejectores.

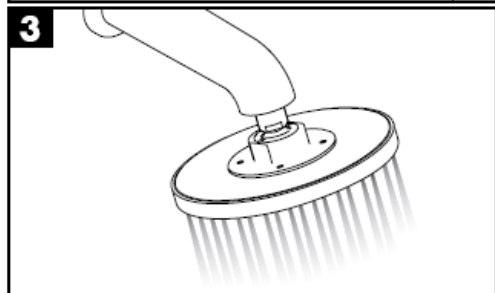
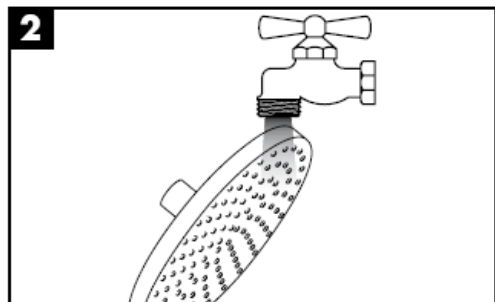
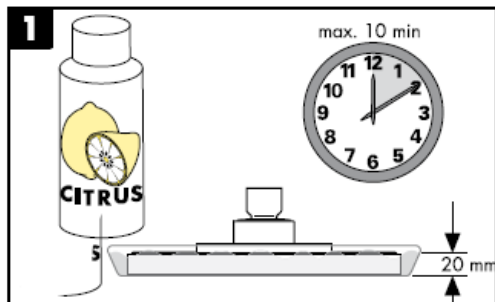
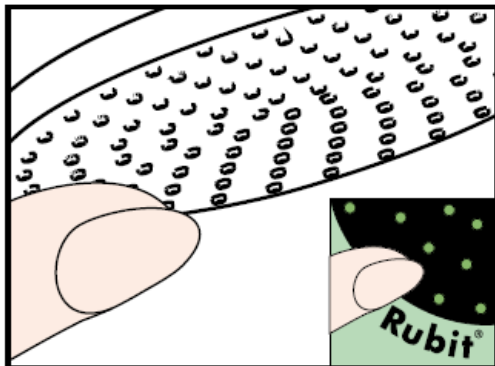

hansgrohe

Handleiding

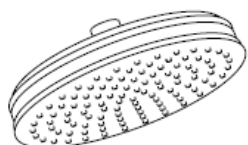

Carlton/Montreux
28474XXX/28487XXX

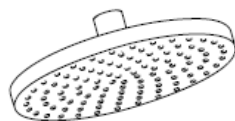

Terrano
28484XXX/28485XXX

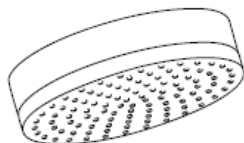

Citterio
28489000

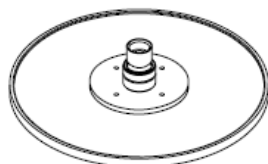

**Starck/Steel/Uno
Air**
28494XXX

AXOR[®]

hansgrohe

Hansgrohe hoofddouches kunnen worden gebruikt in combinatie met hydraulisch en thermisch gestuurde geisers wanneer de druk voor de armatuur minimum 0,15 MPa bedraagt.

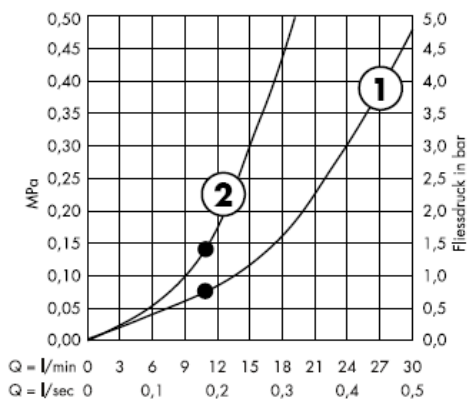

Vanaf • is het functioneren gegarandeerd.

1 Normale douchestraal

Carlton / Montreux
28474XXX

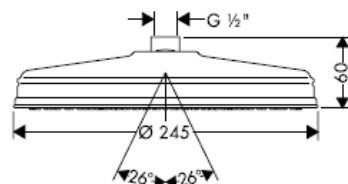

2 Normale douchestraal + Doorstroomgrenzer

Carlton / Montreux
28487XXX

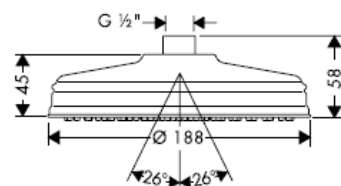

Citterio
28489000

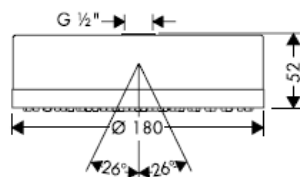

Montage

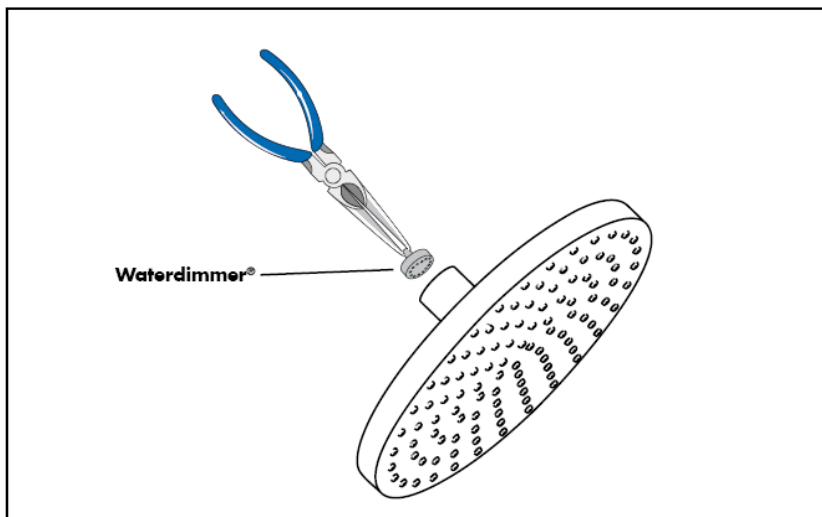
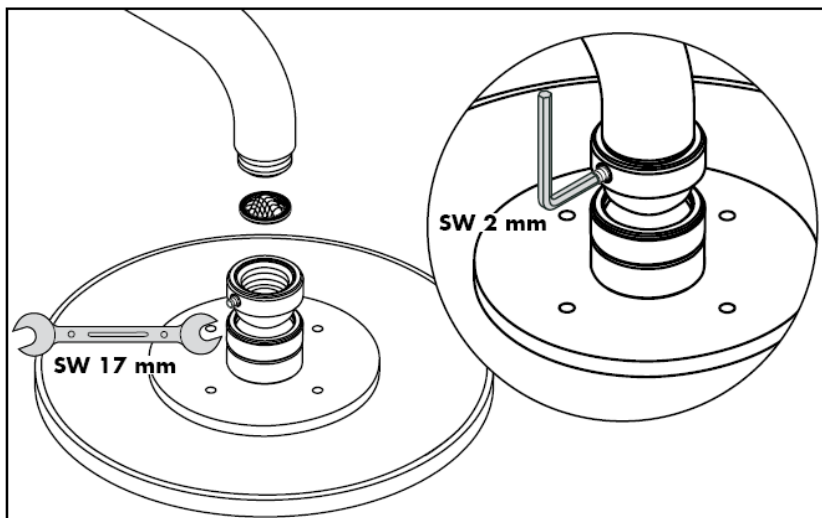

Het bij de hoofddouche verpakte zeefje moet worden ingebouwd om vuil uit de waterleiding te weren. Vuil uit de leidingen kan de werking van de hoofddouche negatief beïnvloeden en/of de hoofddouche beschadigen. Voor deze schade is Hansgrohe niet verantwoordelijk.

Terrano
28484XXX

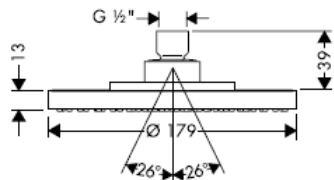

Terrano
28485XXX

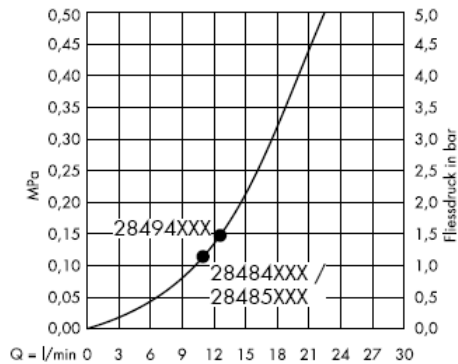
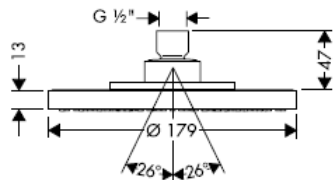

Vanaf • is het functioneren gegarandeerd.

Starck/Steel/Uno Air
28494XXX

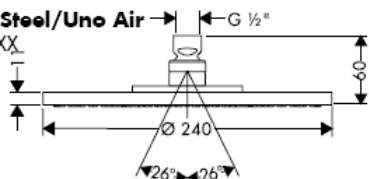

Montage

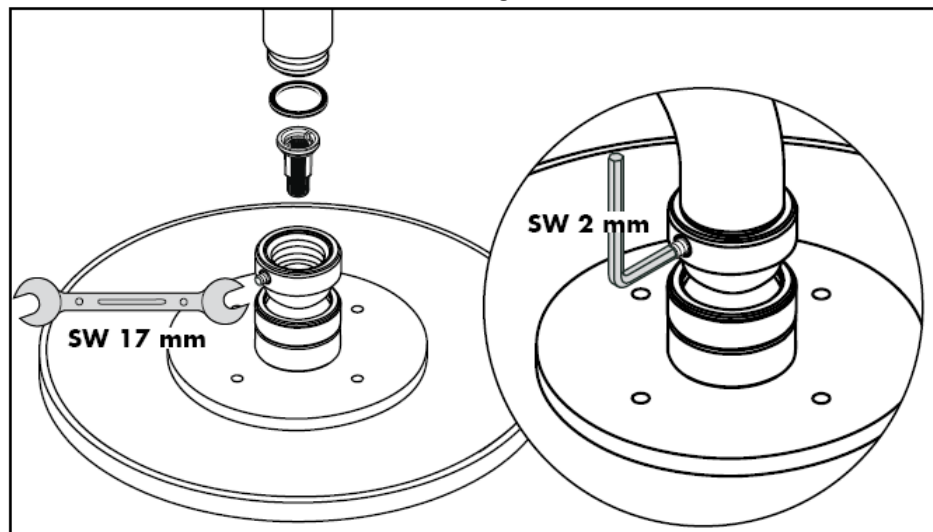

De bijgeleverde filter moet ingebouwd worden om uit de leidingen tegen te houden. Vuil uit de leidingen kan de werking van de hoofddouche negatief beïnvloeden en/of de hoofddouche beschadigen. Voor deze schade is Hansgrohe niet verantwoordelijk.

Reinigen

Met Rubit®, de handmatige reinigingsfunctie, kunnen de straalopeningen door het met de hand wegwrijven van kalk, gereinigd worden.

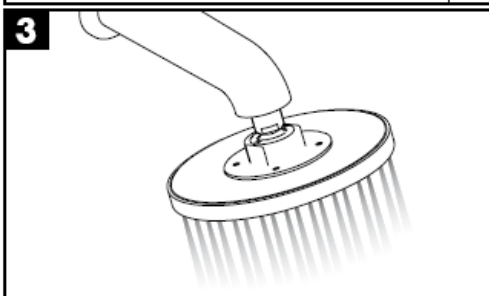
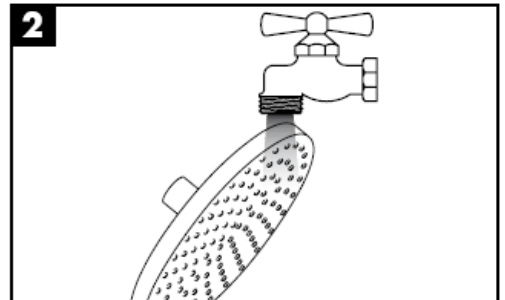
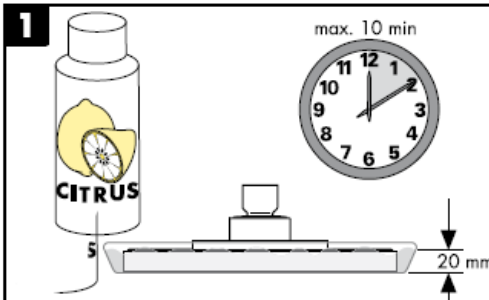
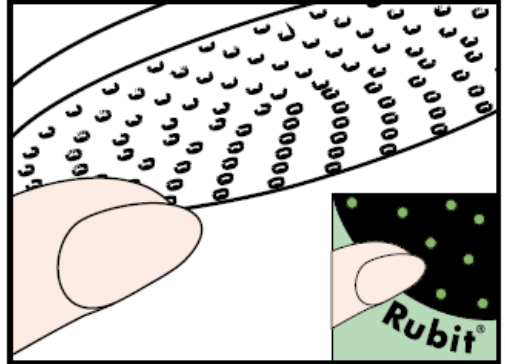

hansgrohe

Monteringsvejledning

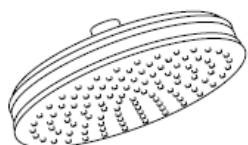

Carlton/Montreux
28474XXX/28487XXX

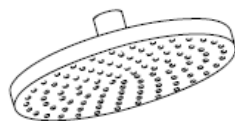

Terrano
28484XXX/28485XXX

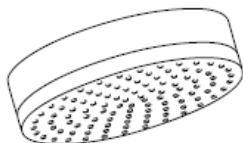

Citterio
28489000

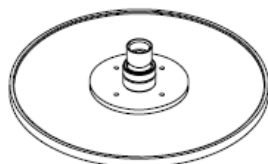

**Starck/Steel/Uno
Air**
28494XXX

AXOR[®]

hansgrohe

Hansgrohe brusere kan anvendes i forbindelse med hydraulisk og termisk styrede gennemstrømningsvandvarmere, hvis trykket er på min. 0,15 MPa.

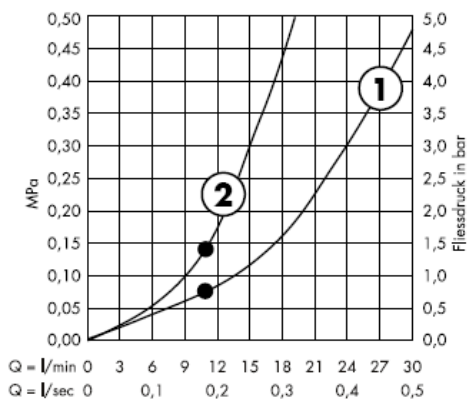

Fra • er funktionen anvendelig.

1 Normalstråle

Carlton / Montreux
28474XXX

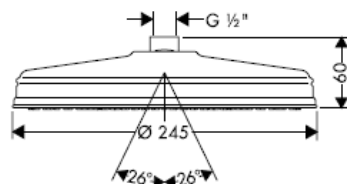

2 Normalstråle +
Gjennomstrømningsbegrenser

Carlton / Montreux
28487XXX

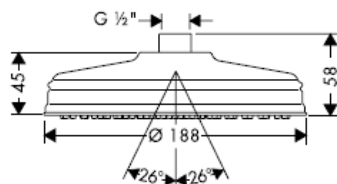

Citterio
28489000

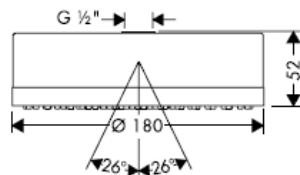

Montering

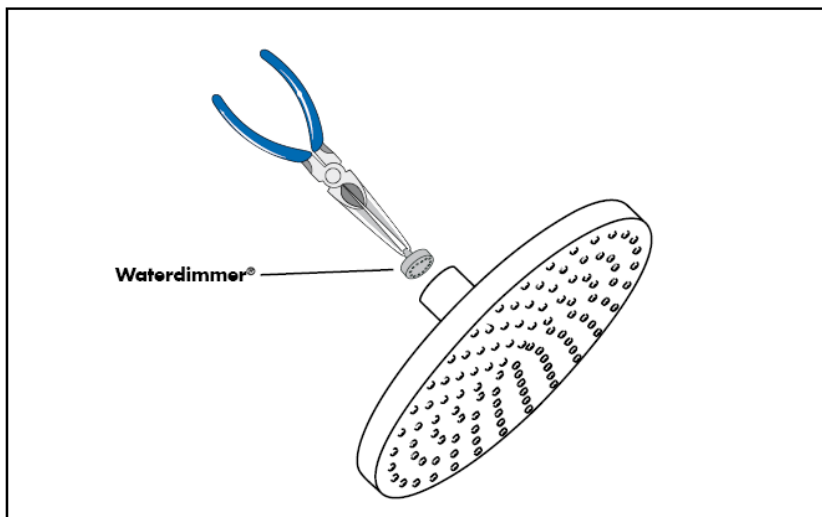
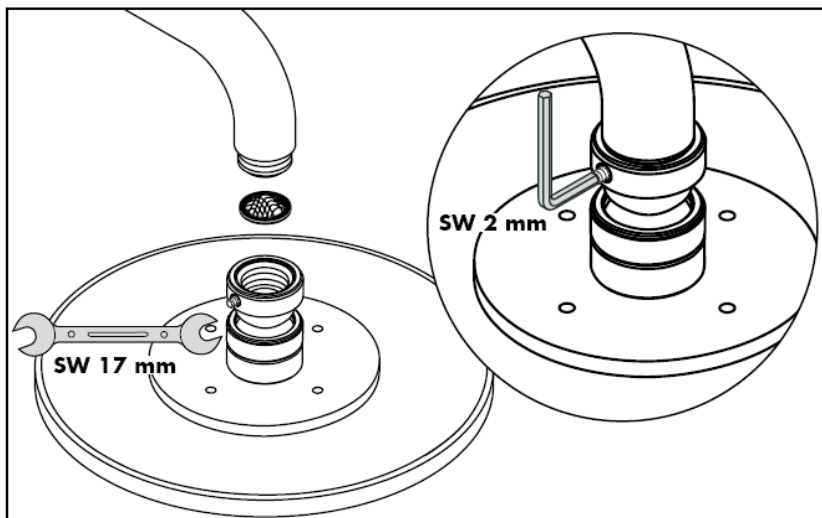

Den vedlagte smudsfangssi skal indsættes i bruseren for at undgå snavs fra rørsystemet. Indskyllet snavs kan have indflydelse på bruserens funktion og/eller føre til beskadigelser på håndbruserens funktionsdele.

Terrano
28484XXX

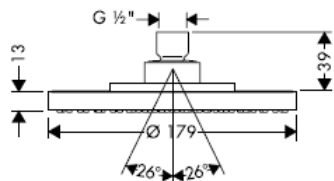

Terrano
28485XXX

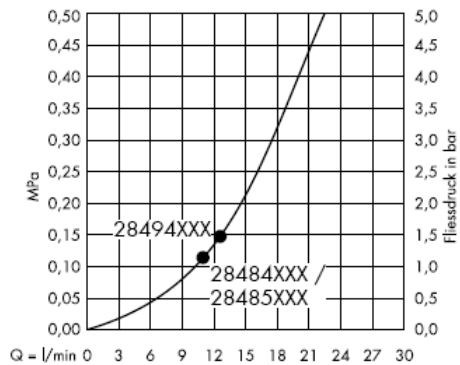
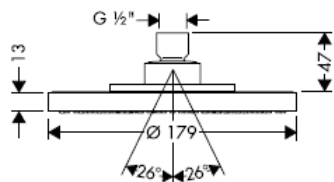

Q = l/min 0 3 6 9 12 15 18 21 24 27 30
Fra • er funktionen anvendelig.

Starck/Steel/Uno Air
28494XXX

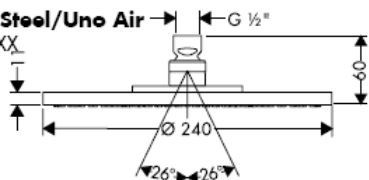

Montering

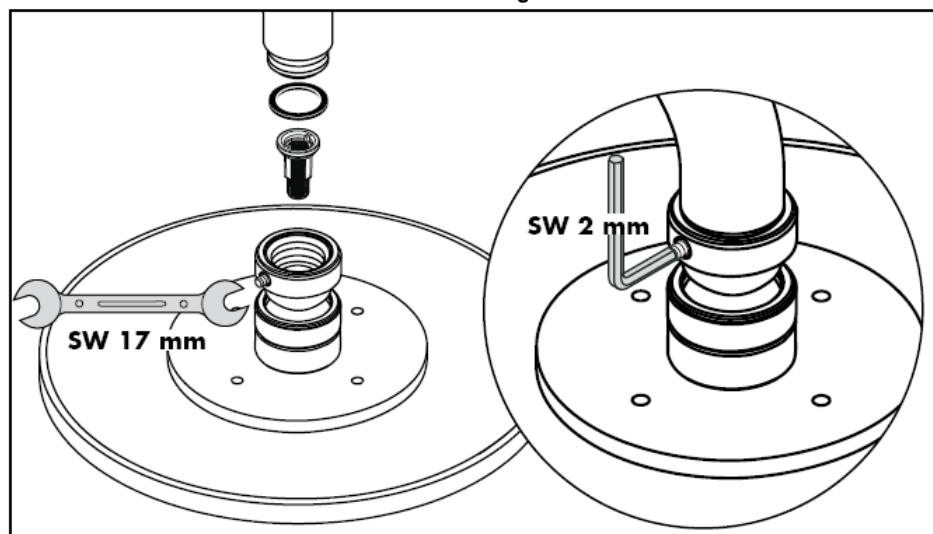

Den vedlagte filterindsats skal monteres for at forhindre at der kommer smuds i bruseren fra rørsystemet. Indskyllet snavs kan have indflydelse på bruserens funktion og/eller føre til beskadigelser på bruserens funktionsdele.

Rengøring

Med Rubit®, den manuelle rengøringsfunktion kan strålekanalerne let renses for kalk - der skal blot gnubbes!

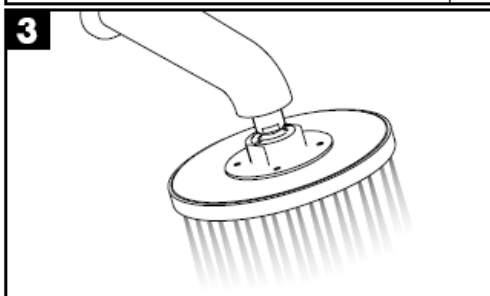
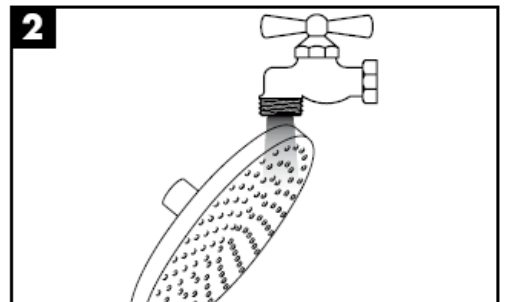
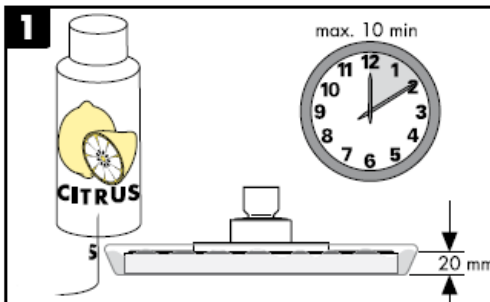
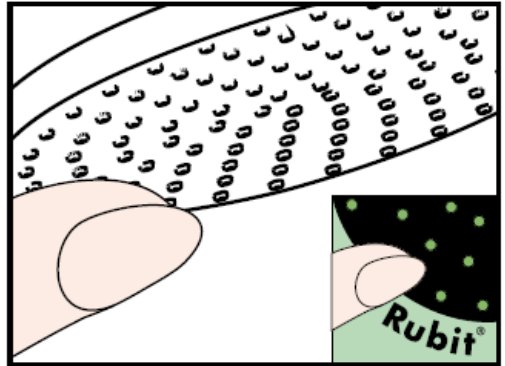

hansgrohe

Manual de Instalación

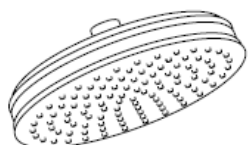

Carlton/Montreux
28474XXX/28487XXX

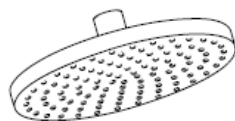

Terrano
28484XXX/28485XXX

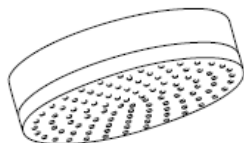

Citterio
28489000

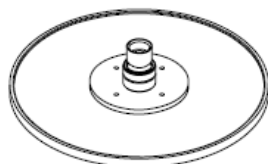

**Starck/Steel/Uno
Air**
28494XXX

AXOR[®]

hansgrohe

Os chuveiros Hansgrohe podem ser utilizados com esquentadores controlados quer hidráulica quer termicamente desde que a pressão seja no mínimo de 0,15 MPa.

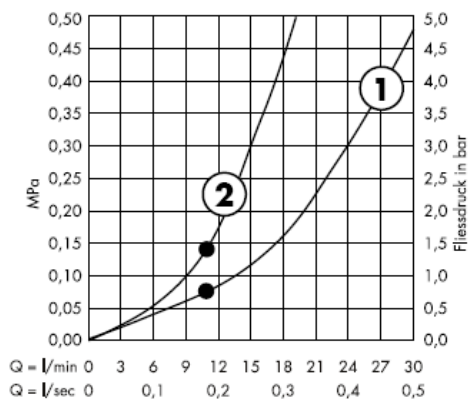

• A partir deste ponto inicia-se o funcionamento correcto.

1 operação normal

2 operação normal + Waterdimmer® (limitador de caudal)

Carlton / Montreux
28474XXX

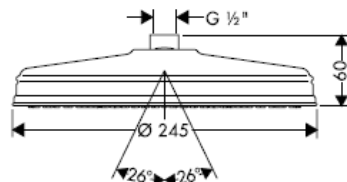

Carlton / Montreux
28487XXX

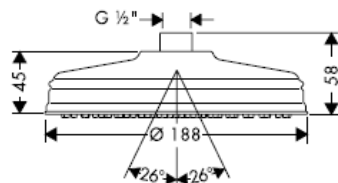

Citterio
28489000

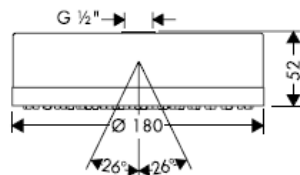

Montagem

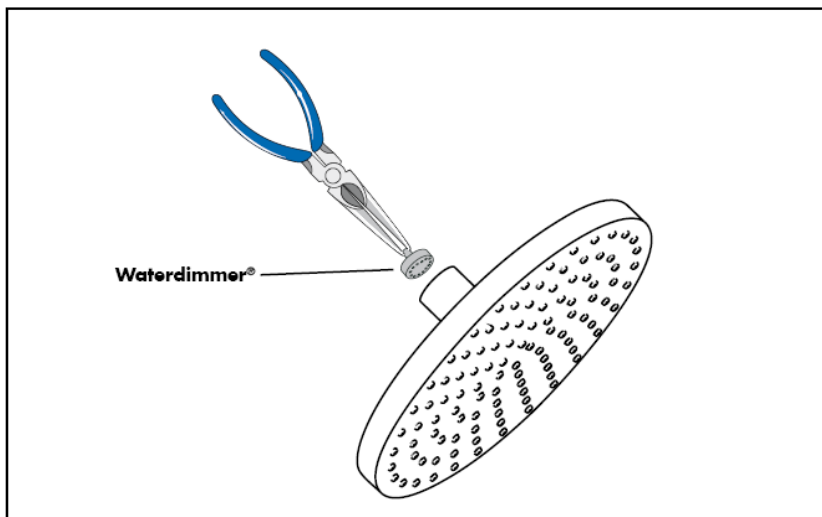
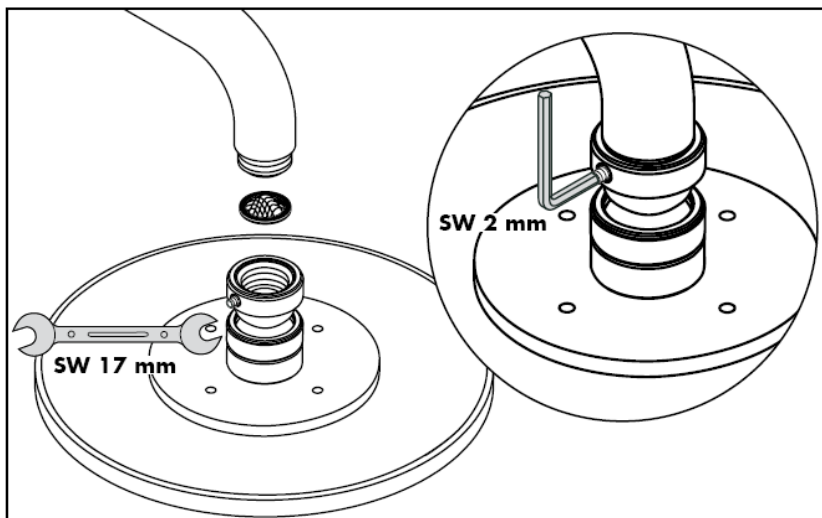

O filtro de rede deve ser colocado para proteger o chuveiro de areias e resíduos provenientes da tubagem. Resíduos e areias podem danificar componentes, ou provocar mau funcionamento do chuveiro; as avarias assim provocadas anulam a nossa responsabilidade e anulam a nossa garantia.

Terrano
28484XXX

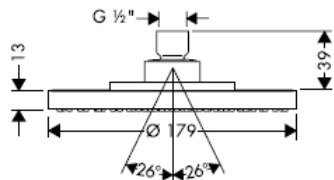

Terrano
28485XXX

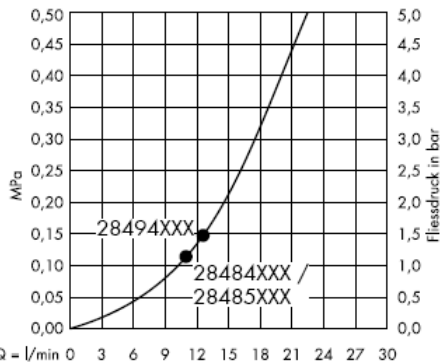
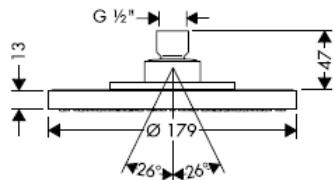

- A partir deste ponto inicia-se o funcionamento correcto.

Starck/Steel/Uno Air
28494XXX

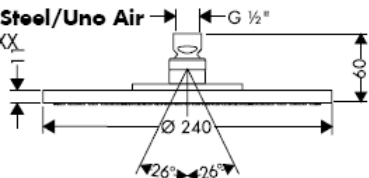

Montagem

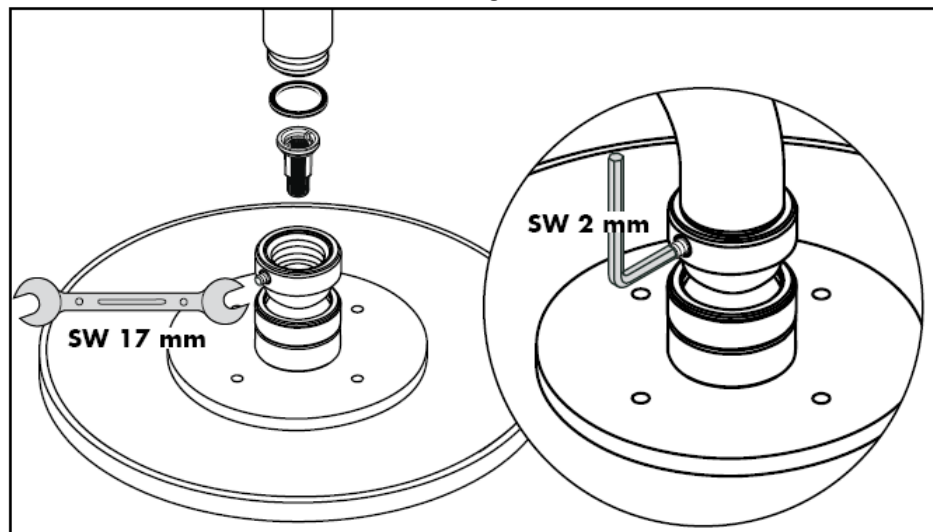

O filtro de inserção deve ser utilizado para proteger o chuveiro de areias e resíduos provenientes da tubagem. Resíduos e areias podem danificar componentes, ou provocar mau funcionamento do chuveiro; as avarias assim provocadas anulam a nossa responsabilidade e anulam a nossa garantia.

Limpeza

O sistema de limpeza Rubit® requer apenas uma ligeira passagem com a mão para remover os depósitos de calcário do emulsor.

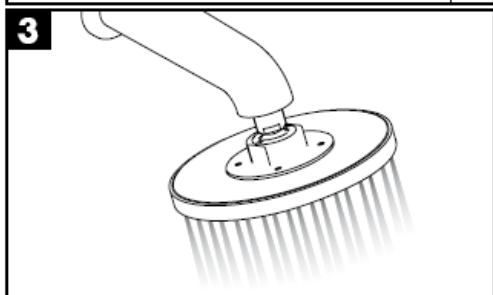
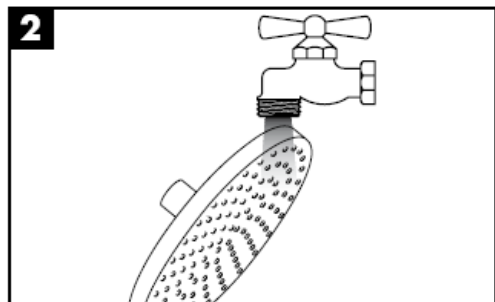
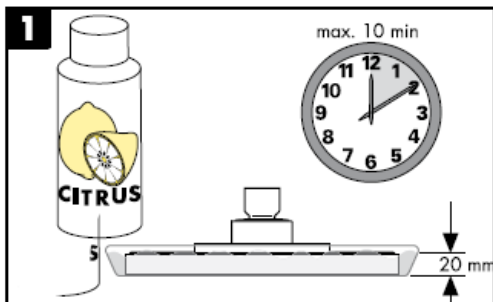
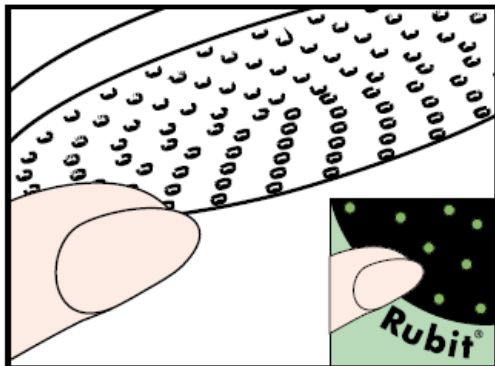

hansgrohe

Instrukcja montażu

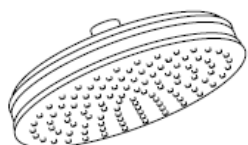

Carlton/Montreux
28474XXX/28487XXX

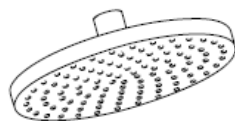

Terrano
28484XXX/28485XXX

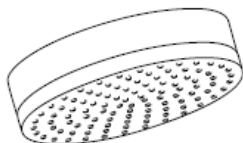

Citterio
28489000

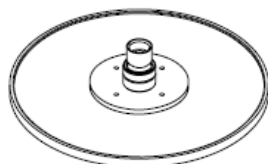

**Starck/Steel/Uno
Air**
28494XXX

AXOR[®]

hansgrohe

Prysznice Hansgrohe mogą być stosowane w połączeniu z przepływowymi podgrzewaczami wody sterowanymi hydraulicznie lub termicznie w przypadku, gdy ciśnienie przepływu przed armaturą wynosi co najmniej 0,15 MPa.

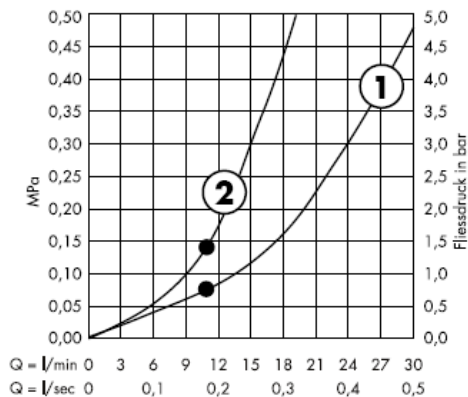

Od • możliwe jest funkcjonowanie.

① Strumień normalny

Carlton / Montreux
28474XXX

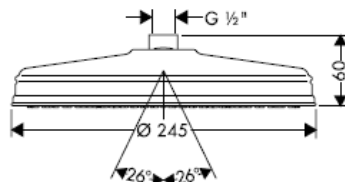

② Strumień normalny + Waterdimmer® (ogranicznik przepływu)

Carlton / Montreux
28487XXX

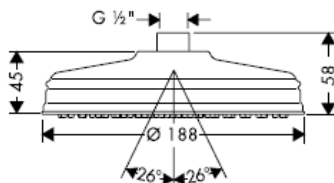

Citterio
28489000

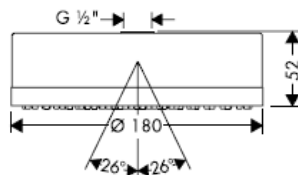

Montaż

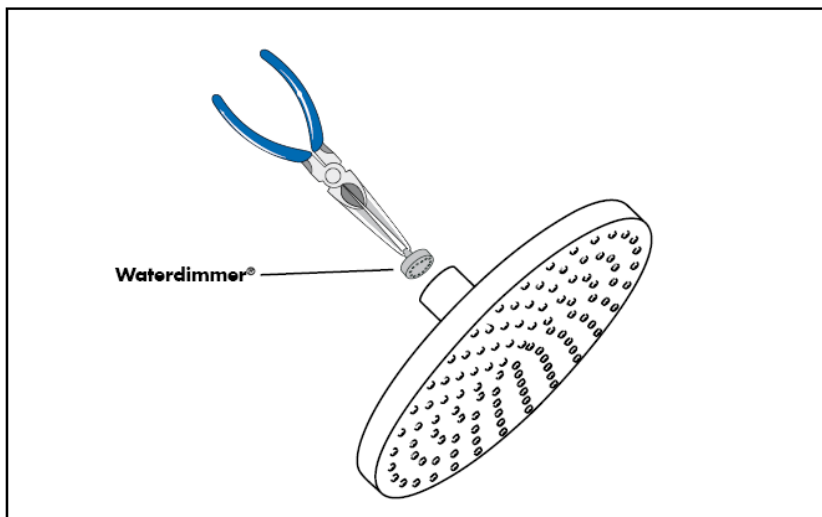
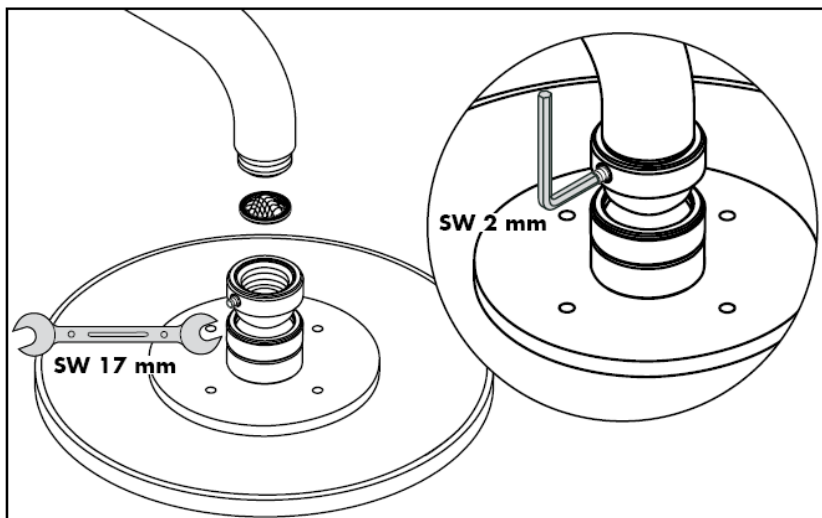

Znajdujące się przy prysznicu sitko musi zostać zainstalowane, aby zatrzymać zanieczyszczenia z instalacji. Przedostające się zanieczyszczenia mogą mieć ujemny wpływ na działanie i/lub prowadzić do usterek w działaniu elementów prysznicza. Za powstałe z tego tytułu szkody firma Hansgrohe nie ponosi odpowiedzialności.

Terrano
28484XXX

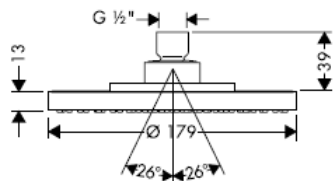

Terrano
28485XXX

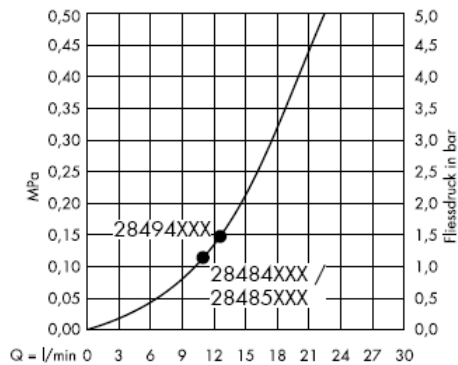
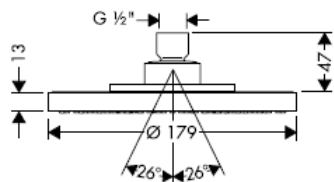

Od • możliwe jest funkcjonowanie.

Starck/Steel/Uno Air
28494XXX

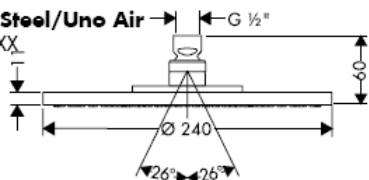

Montaż

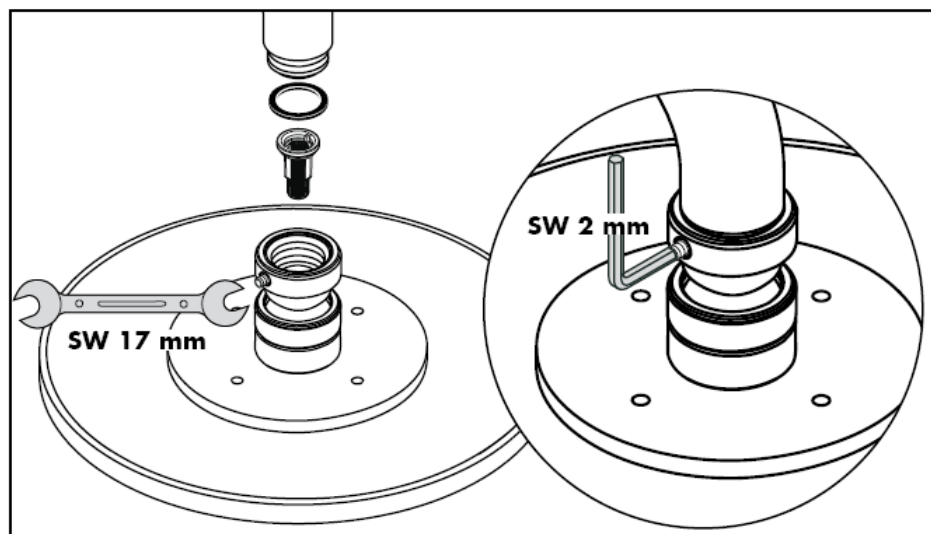

Dołożony do opakowania filtr musi zostać zamontowany, jej zabezpieczeniu przed zabrudzeniami z rur. Zanieczyszczenia mogą prowadzić do nieprawidłowego działania prysznicy lub spowodować jego uszkodzenie, za tak powstałe uszkodzenia Hansgrohe nie przejmuje odpowiedzialności.

Czyszczenie

Funkcja Rubit® wymaga jedynie delikatnego potarcia dłonią, aby usunąć ewentualne osady kamienia wapiennego.

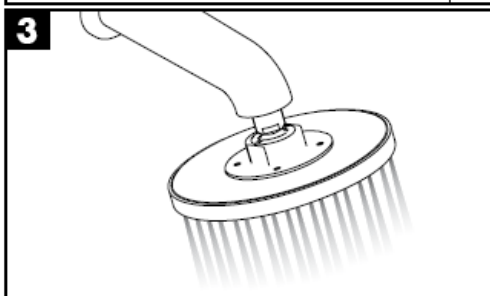
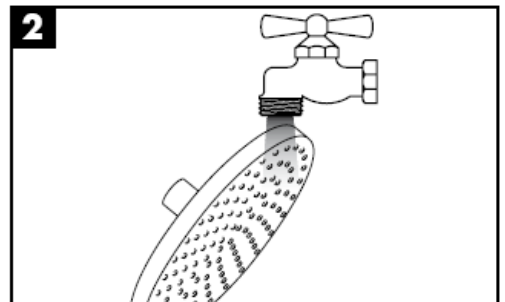
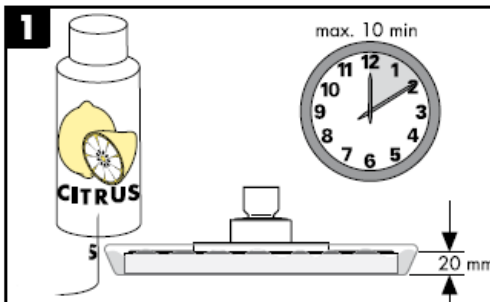
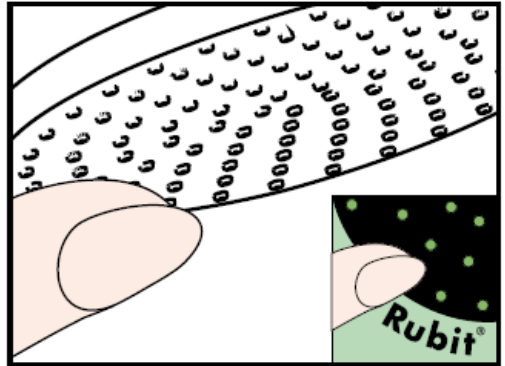

hansgrohe

Montážní návod

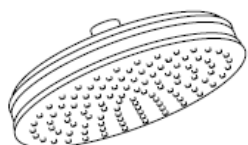

Carlton/Montreux
28474XXX/28487XXX

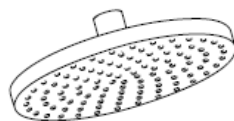

Terrano
28484XXX/28485XXX

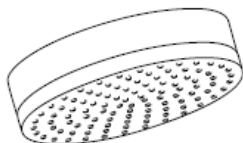

Citterio
28489000

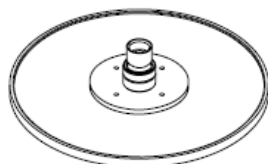

**Starck/Steel/Uno
Air**
28494XXX

AXOR[®]

hansgrohe

Sprchy Hansgrohe je možné používat s hydraulicky a tepelně řízenými průtokovými ohřivači, pokud je tlak před armaturou alespoň 0,15 MPa.

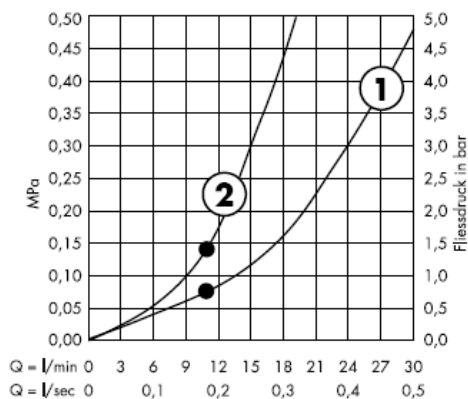

Od • je zaručená funkce

1 Normální proud

Carlton / Montreux
28474XXX

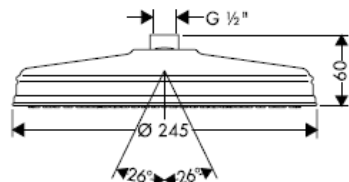

2 Normální proud + Waterdimmer® (omezovač průtoku)

Carlton / Montreux
28487XXX

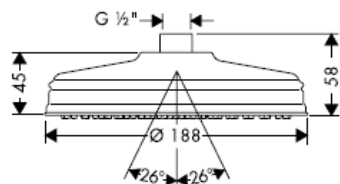

Citterio
28489000

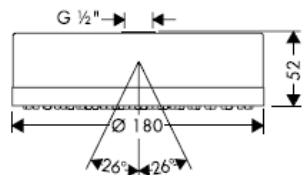

Montáž

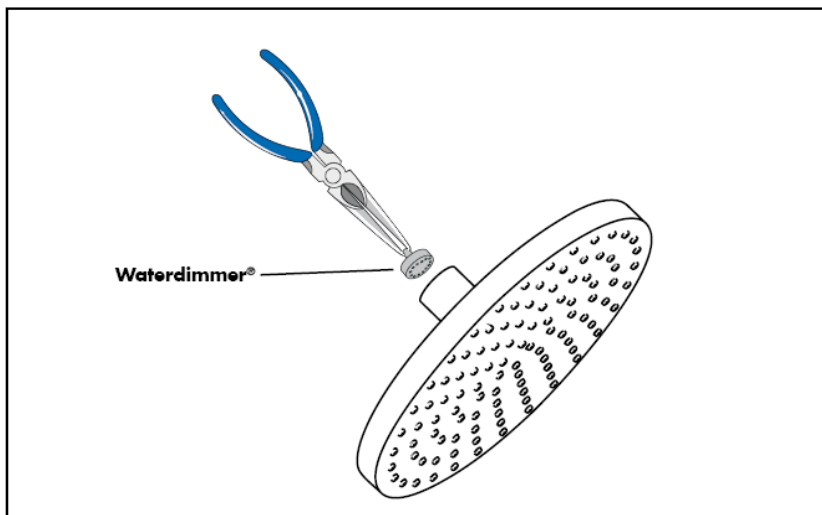
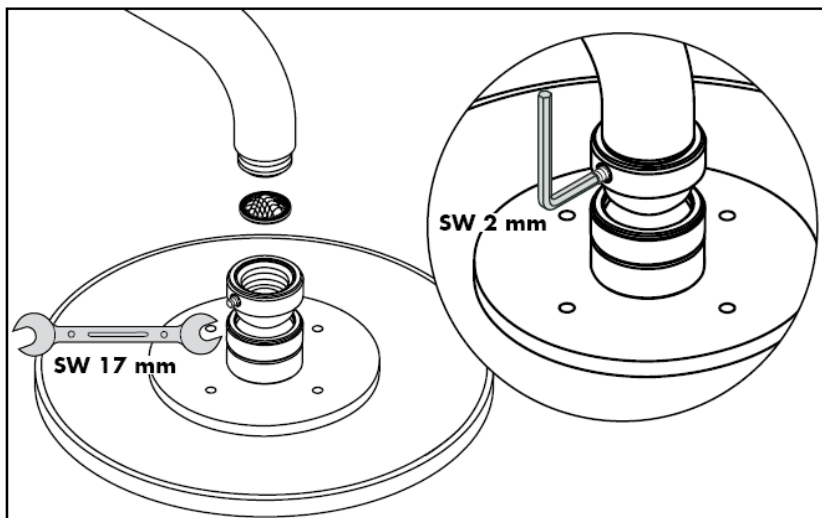

Do přívodu musí být zabudováno se sprchou dodávané sítko, aby zachycovalo nečistoty vyplavené z vodovodní sítě. Vyplavené nečistoty mohou ovlivnit funkci sprchy a nebo mohou vést i k jejímu poškození. Na takto vzniklé škody se nevztahuje záruka firmy Hansgrohe.

Terrano
28484XXX

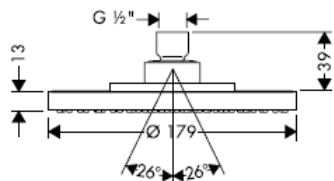

Terrano
28485XXX

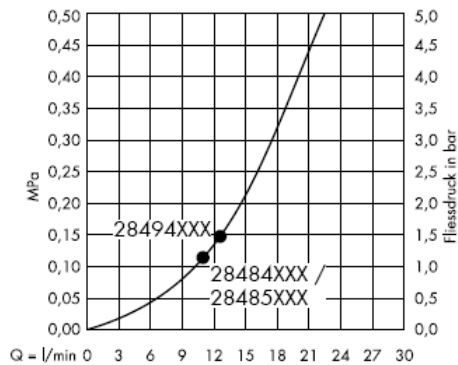
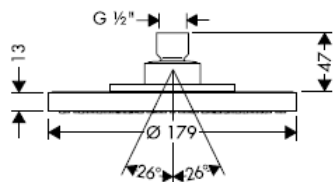

Od • je zaručená funkce

Starck/Steel/Uno Air
28494XXX

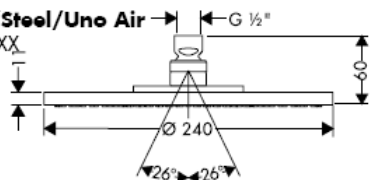

Montáž

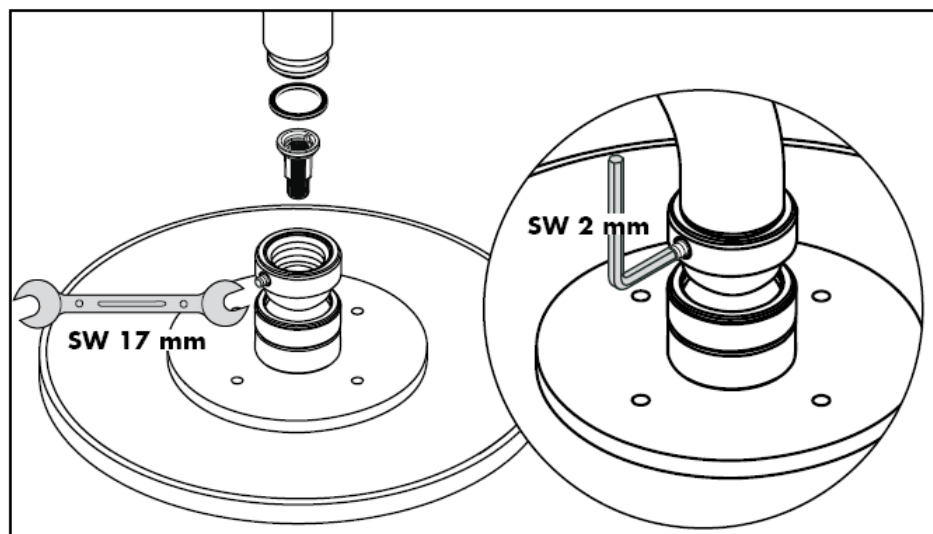

Do přívodu musí být zabudováno se sprchou dodávané sítko, aby zachycovalo nečistoty vyplavené z vodovodní sítě. Vyplavené nečistoty mohou ovlivnit funkci sprchy a nebo mohou vést i k jejímu poškození. Na takto vzniké škody se nevztahuje záruka firmy Hansgrohe.

Čištění

S ruční čisticí funkcí Rubit® stačí jednoduché odstranění vodního kamene prsty z trysek kotouče tvarujícího proud vody.

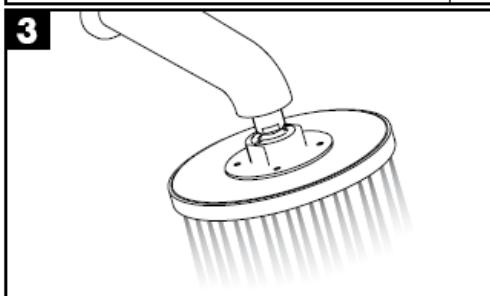
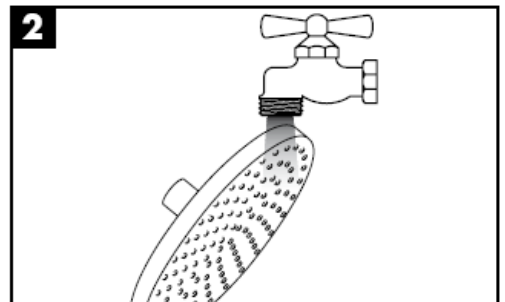
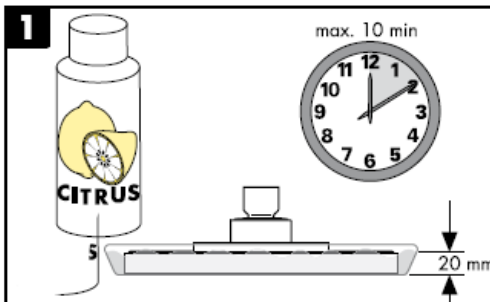
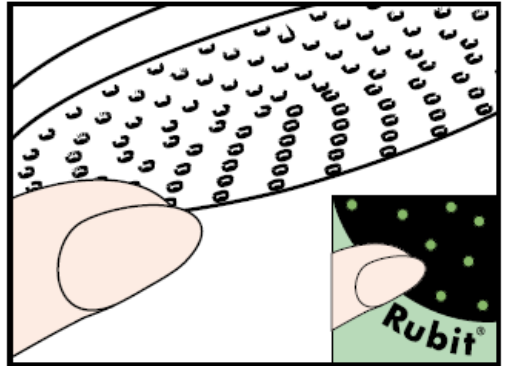

hansgrohe

Montážny návod

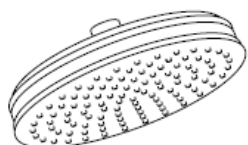

Carlton/Montreux
28474XXX/28487XXX

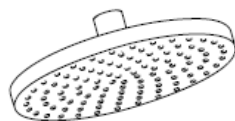

Terrano
28484XXX/28485XXX

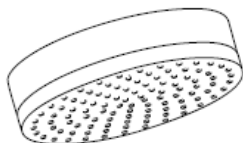

Citterio
28489000

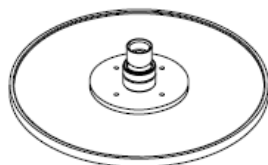

**Starck/Steel/Uno
Air**
28494XXX

AXOR[®]

hansgrohe

Sprchy Hansgrohe je možné používať s hydraulicky a tepelne riadenými prietokovými ohrievačmi, pokiaľ je tlak pred armatúrou min. 0,15 MPa.

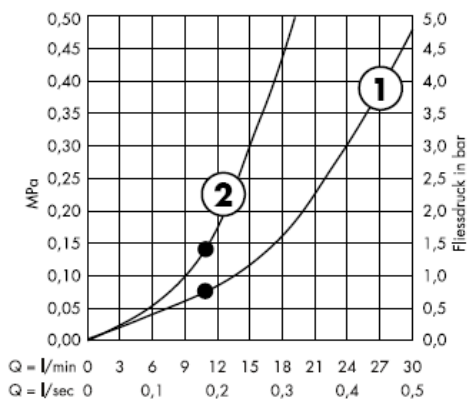

Od • je zaručená funkcia.

1 Normálny prúd

Carlton / Montreux
28474XXX

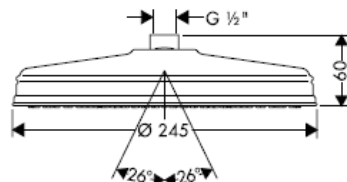

2 Normálny prúd + Waterdimmer® (obmedzenie prietoku)

Carlton / Montreux
28487XXX

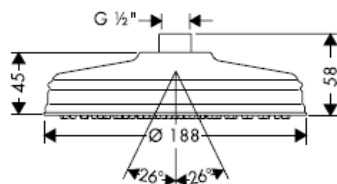

Citterio
28489000

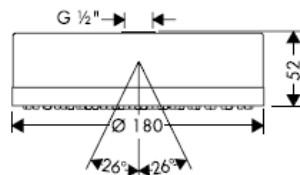

Montáž

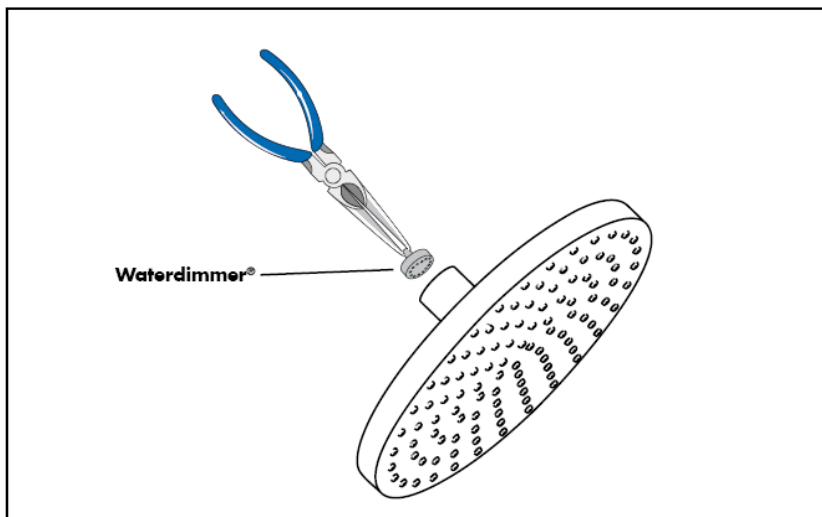
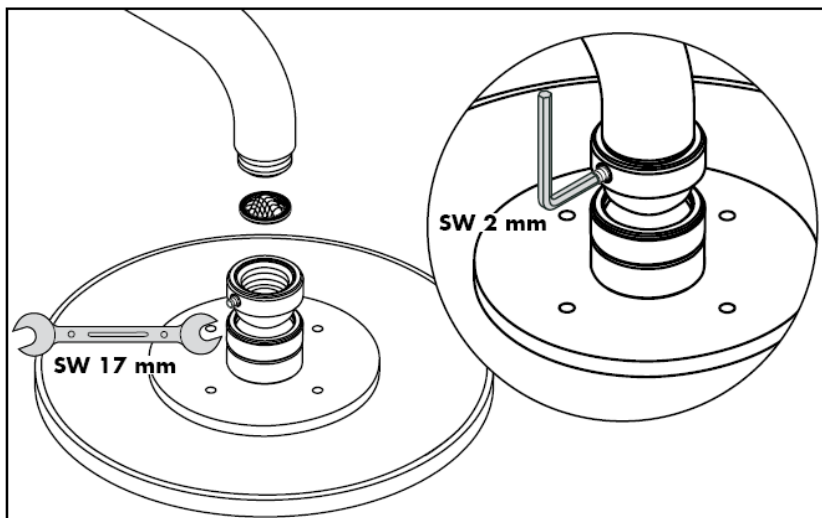

Do prívodu musí byť zabudované so sprchou dodávané sítka, aby zachytilo nečistoty vyplavené z vodovodnej siete. Vyplavené nečistoty môžu ovplyvniť funkciu sprchy, alebo spôsobiť jej poškodenie. Na takto vzniknuté škody sa nevzťahuje záruka firmy Hansgrohe.

Terrano
28484XXX

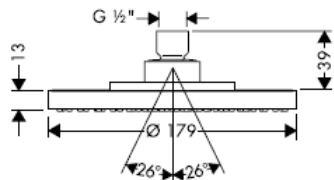

Terrano
28485XXX

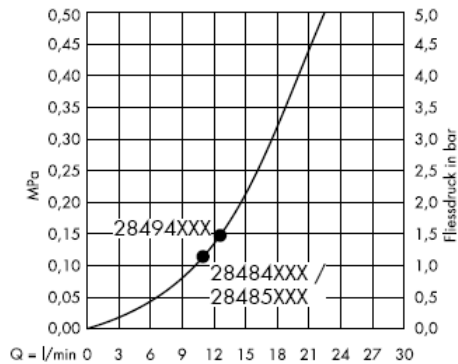
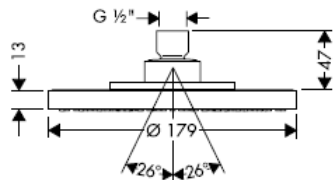

Od • je zaručená funkcia.

Starck/Steel/Uno Air
28494XXX

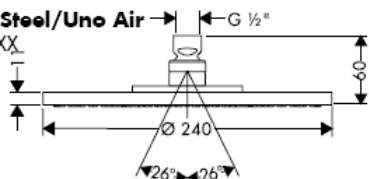

Montáž

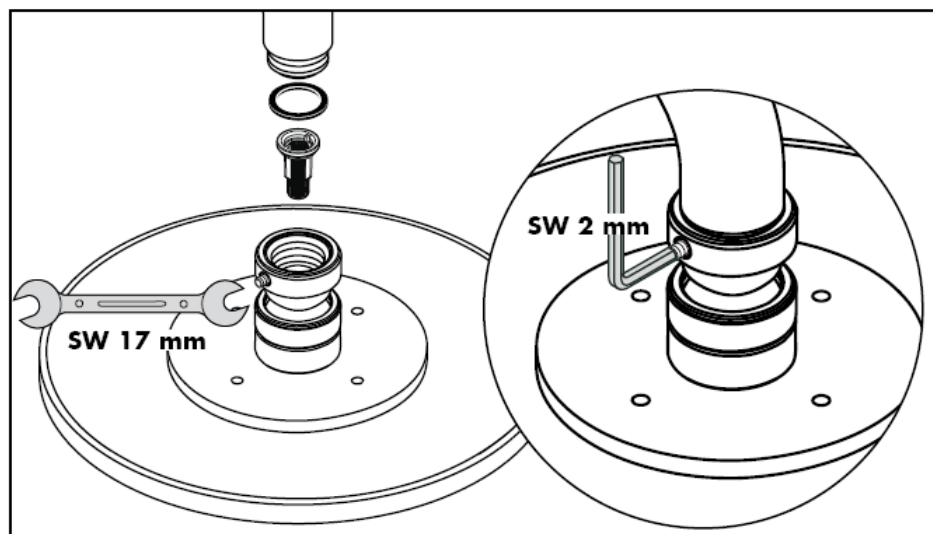

Do prívodu musí byť zabudované so sprchou dodávané sítka, aby zachytilo nečistoty vyplavené z vodovodnej siete. Vyplavené nečistoty môžu ovlivniť funkciu sprchy, alebo spôsobiť jej poškodenie. Na takto vzniknuté škody sa nevzťahuje záruka firmy Hansgrohe.

Čištění

Čistiaca funkcia Rubit, stačí na jednoduché odstránenie vodného kameňa prstami z trysiek kotúča tvarujúceho prúd vody.

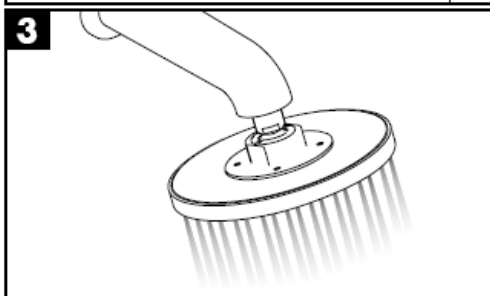
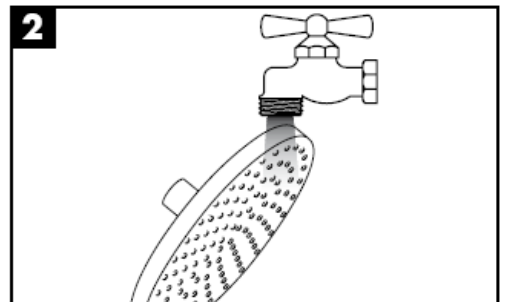
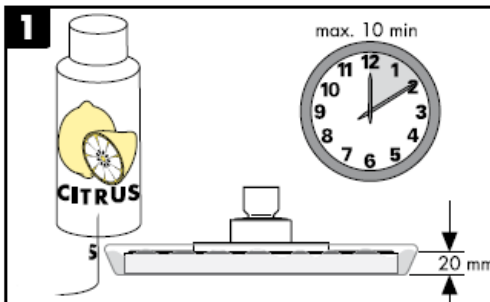
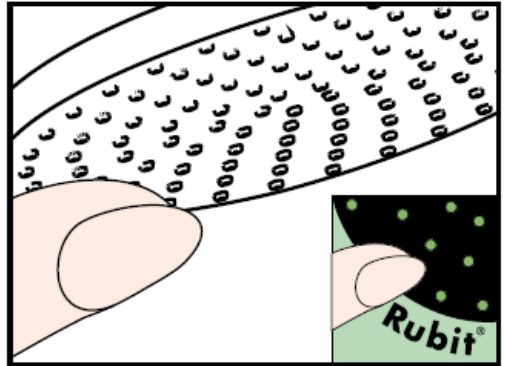

hansgrohe

组装说明

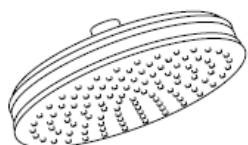

Carlton/Montreux
28474XXX/28487XXX

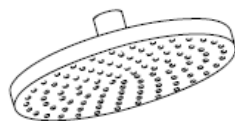

Terrano
28484XXX/28485XXX

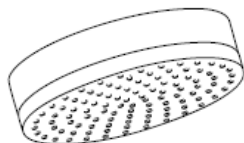

Citterio
28489000

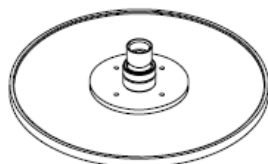

**Starck/Steel/Uno
Air**
28494XXX

AXOR[®]

hansgrohe

如果龙头前的水压至少达到1.5 bar，汉斯格雅花洒可以和液压式或热控式连续流热水器一起使用。

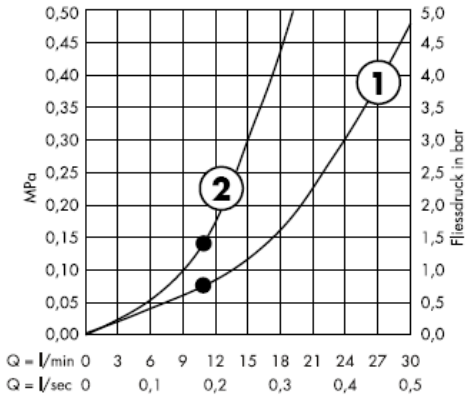

从•开始，正常功能得以保证。

① 普通水流

Carlton / Montreux
28474XXX

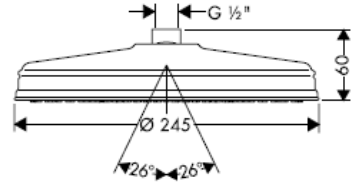

② 正常喷头 + Waterdimmer®
(流量限制器)

Carlton / Montreux
28487XXX

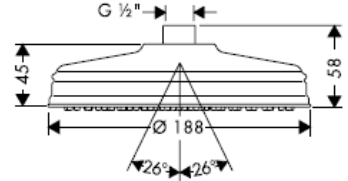

Citterio
28489000

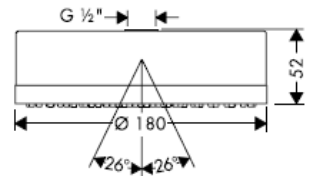

安装

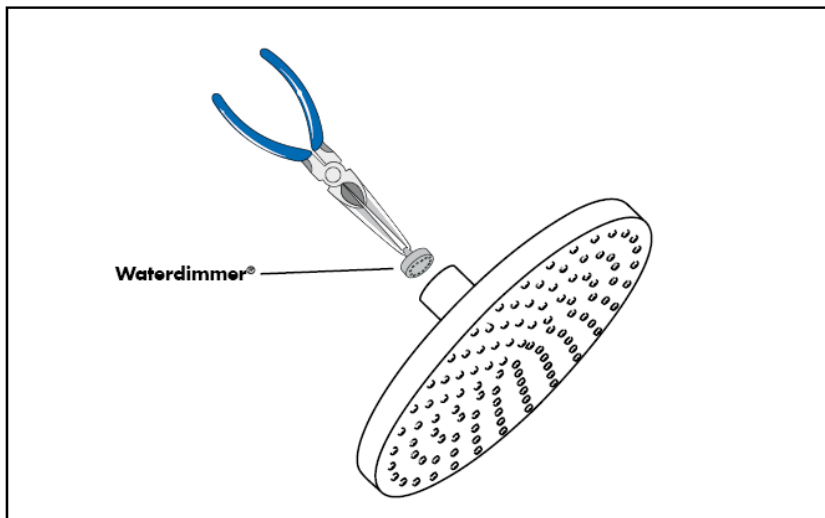
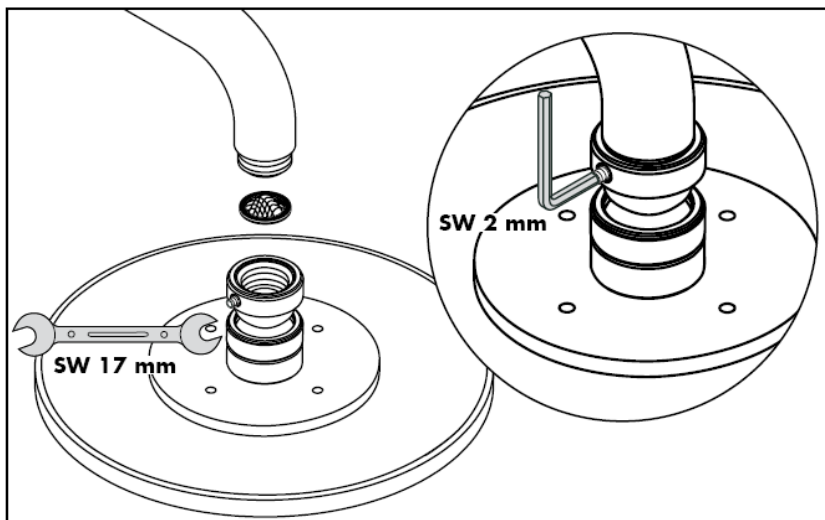

必须装上花洒所附带的滤网密封垫，以过滤管道里的杂质污物。杂质污物会影响花洒的功能和/或损坏花洒的功能部件，由此而产生的产品损坏不属于汉斯格雅的保修范围。

Terrano
28484XXX

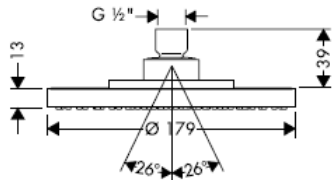

Terrano
28485XXX

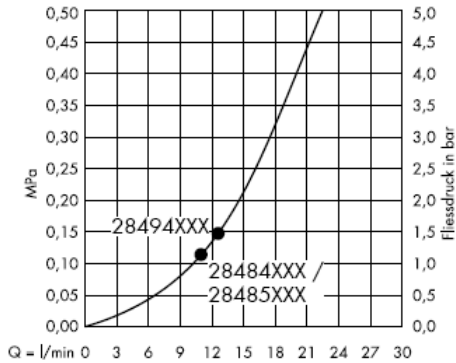
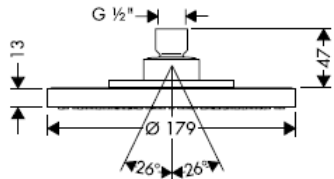

从•开始，正常功能得以保证。

Starck/Steel/Uno Air
28494XXX

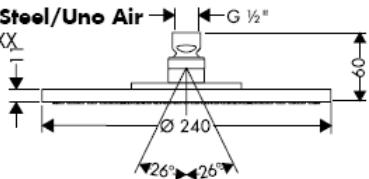

安装

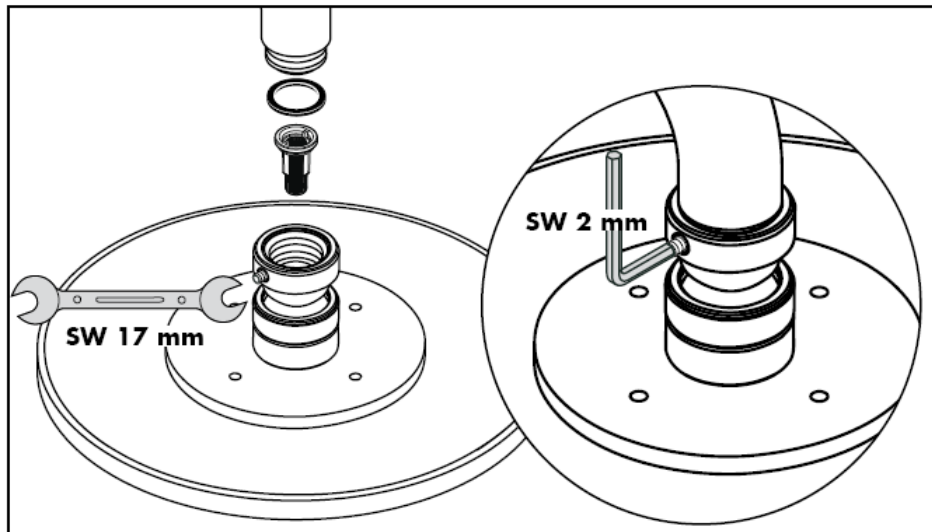

必须装上花洒所附带的滤柱密封垫，
以过滤管道里的杂质污物。杂质污物会影响花洒
的功能和/或损坏花洒的功能部件，由此而产生
的产品损坏不属于汉斯格雅的保修范围。

清洗

有了Rubit®, 手工清洁功能, 要去掉喷头上的水垢, 只需简单地搓除即可。

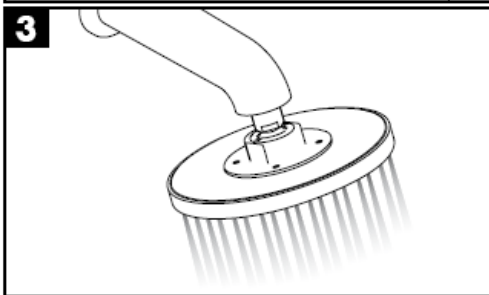
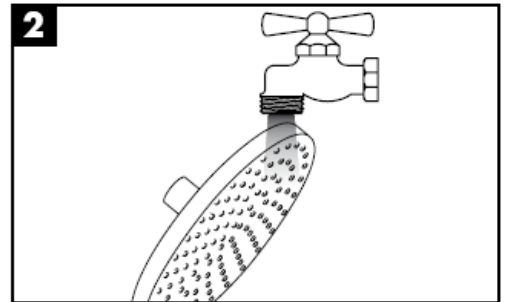
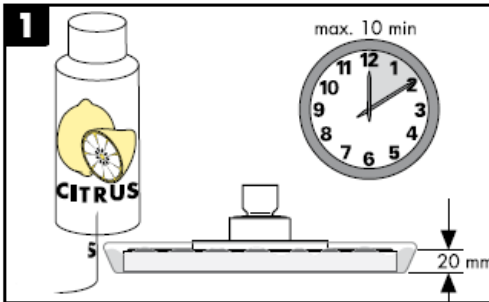
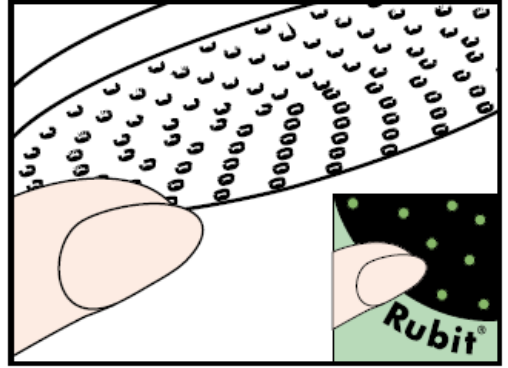

hansgrohe

Hansgrohe · Postfach 1145 · D-77761 Schiltach · Telefon +49 (0) 78 36/51-1282 · Telefax +49 (0) 7836/511440
E-Mail: info@hansgrohe.com · Internet: www.hansgrohe.com

11/2007
9.08534.08
中文

Инструкция по монтажу

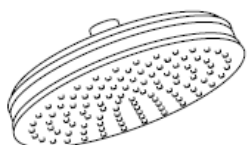

Carlton/Montreux
28474XXX/28487XXX

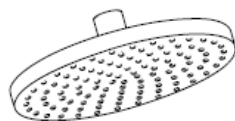

Terrano
28484XXX/28485XXX

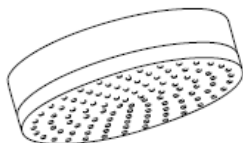

Citterio
28489000

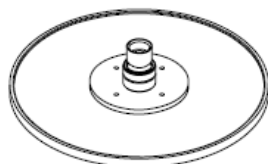

**Starck/Steel/Uno
Air**
28494XXX

AXOR[®]

hansgrohe

Души Hansgrohe можно использовать с проточными водонагревателями с гидравлическим и термическим управлением, если напор воды в зоне до арматуры составляет не менее 0,15 МПа.

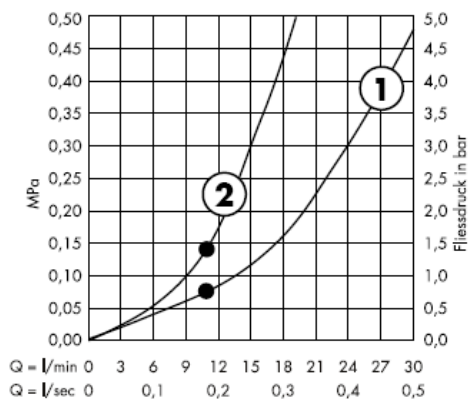

Гарантированное функционирование при показателях выше •.

1 Нормальная струя

Carlton / Montreux
28474XXX

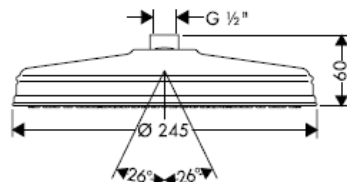

2 Нормальная струя + Waterdimmer® (ограничитель расхода воды)

Carlton / Montreux
28487XXX

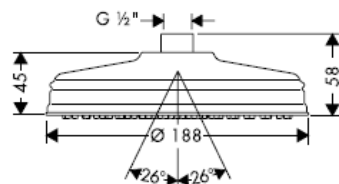

Citterio
28489000

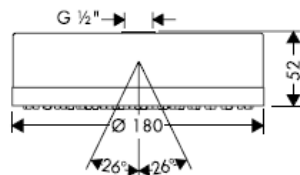

Монтаж

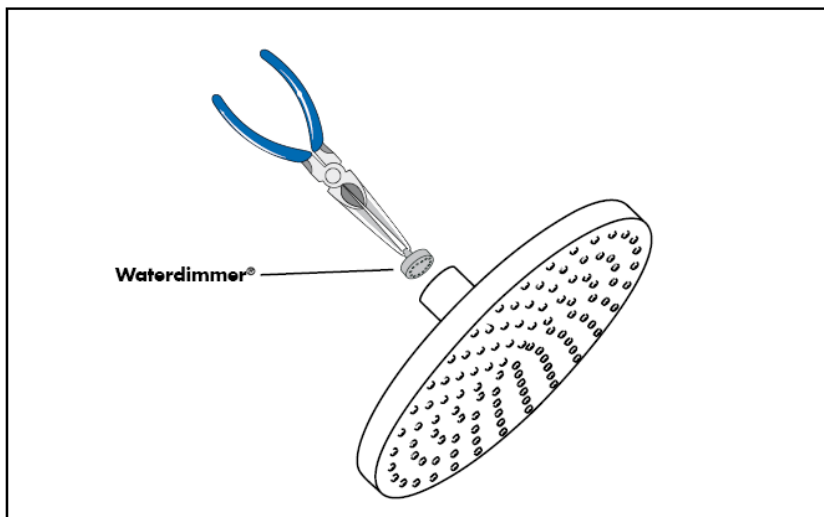
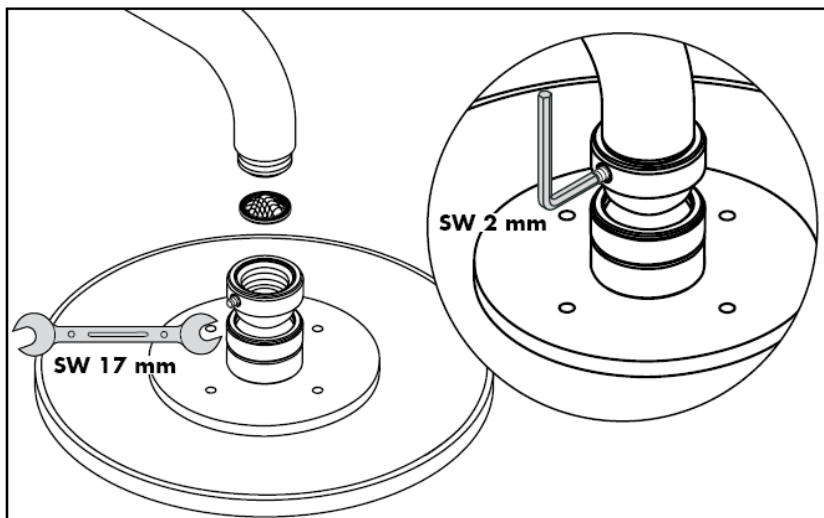

Для предотвращения попадания частиц грязи из водопроводной сети необходимо установить фильтр, прилагаемый к ручному душу. Частицы грязи могут нарушить отдельные функции и/или привести к повреждению функциональных деталей ручного душа. Hansgrohe не несет ответственность за повреждения вследствие отсутствия фильтра.

Terrano
28484XXX

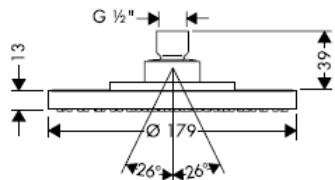

Terrano
28485XXX

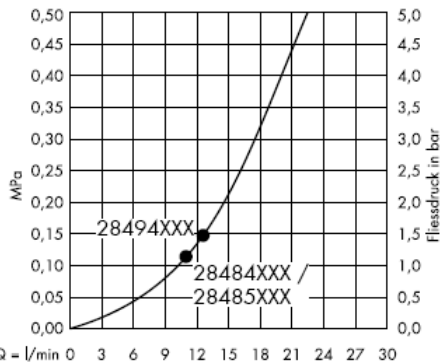
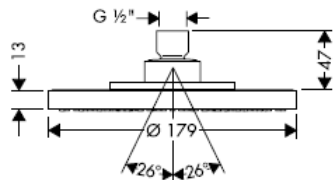

Гарантированное функционирование при показателях свыше •.

Starck/Steel/Uno Air
28494XXX

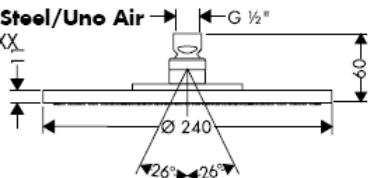

Монтаж

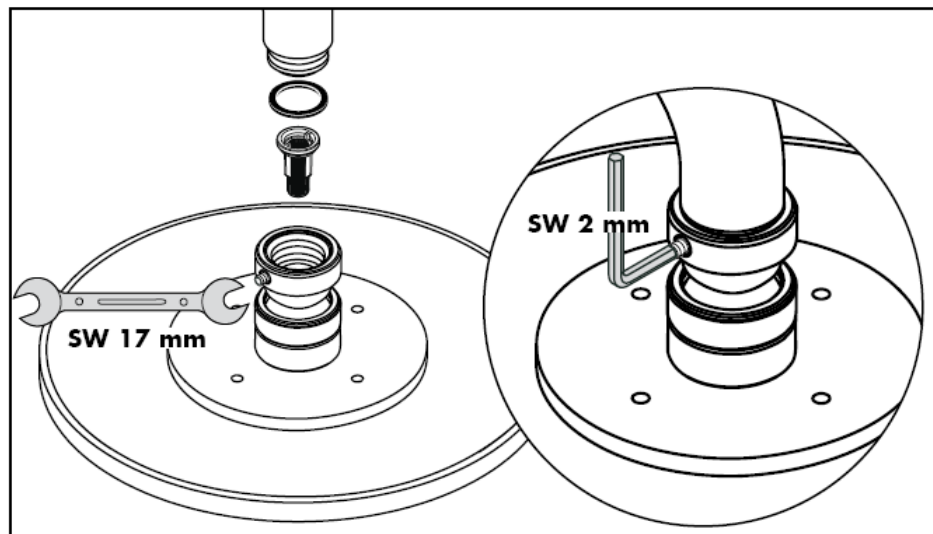

Для предотвращения попадания частиц грязи из водопроводной сети необходимо установить фильтр, прилагаемый к ручному душу. Частицы грязи могут нарушить отдельные функции и/или привести к повреждению функциональных деталей ручного душа, Hansgrohe не несет ответственность за повреждения вследствие отсутствия фильтра.

Очистка

система Rubit® позволяет удалять известковые отложения, достаточно провести по эластичной поверхности аэратора пальцем, как известковые отложения будут удалены.

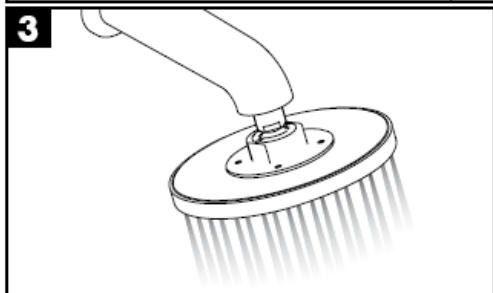
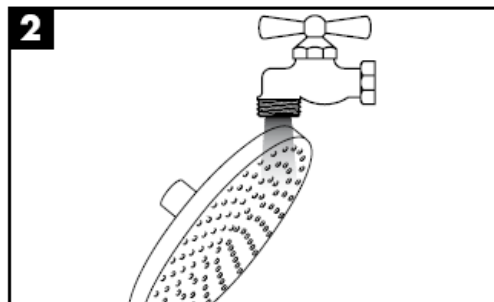
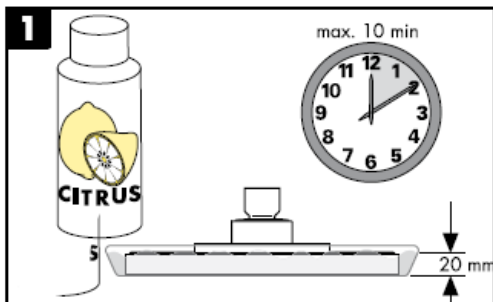
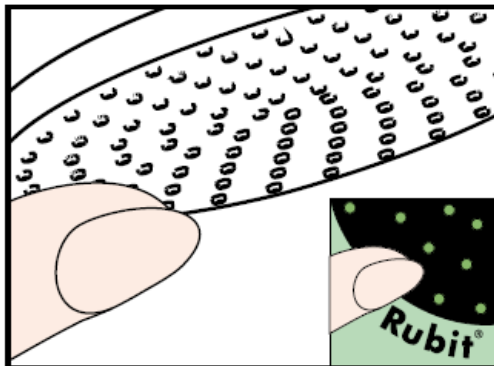

hansgrohe

Szerelési útmutató

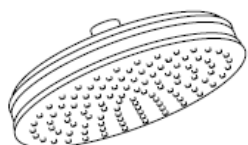

Carlton/Montreux
28474XXX/28487XXX

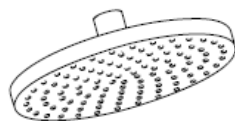

Terrano
28484XXX/28485XXX

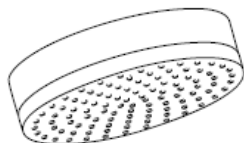

Citterio
28489000

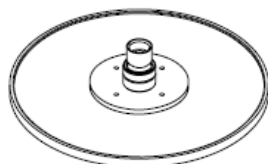

**Starck/Steel/Uno
Air**
28494XXX

AXOR[®]

hansgrohe

A Hansgrohe zuhanyok kizárólag akkor használhatóak hidraulikus vagy termikus átfolyós vízmelegítővel, ha a víznyomás a csaptelep előtt minimum az 0,15 MPa-t eléri.

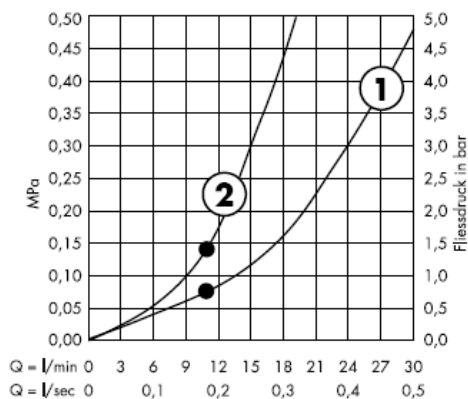

A • -től működik az adott funkció.

① Normálsugár

Carlton / Montreux
28474XXX

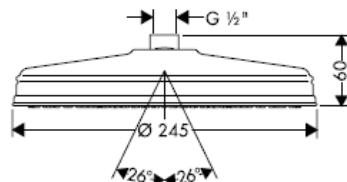

② Normálsugár + Waterdimmer (átfolyásszabályozó)

Carlton / Montreux
28487XXX

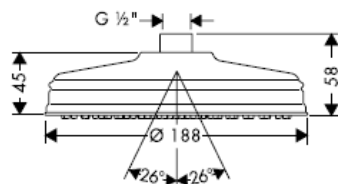

Citterio
28489000

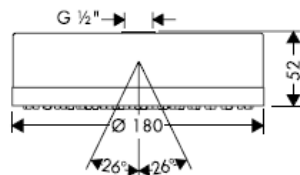

Szerelés

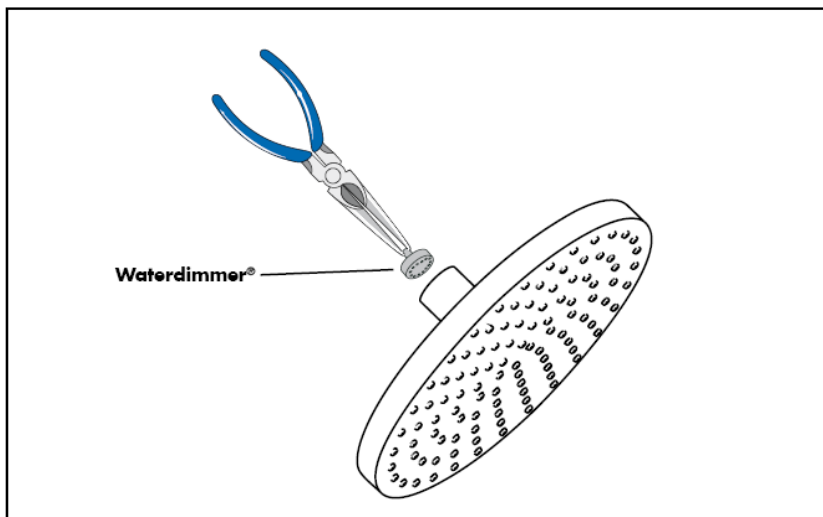
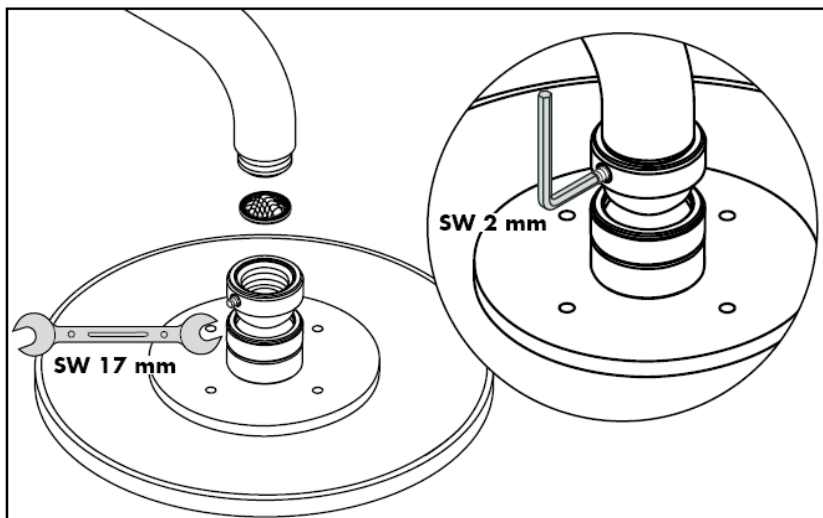

A kézi zuhanyhoz csomagolt szűrőtömítést be kell szerelni a vízhálózatból származó szennyeződések kiküszöbölésére. A beáramló szennyeződések akadályozhatják és / vagy teljesen tönkre is tehetik a zuhany funkciót. Az ezekből adódó károkért a Hansgrohe nem felel.

Terrano
28484XXX

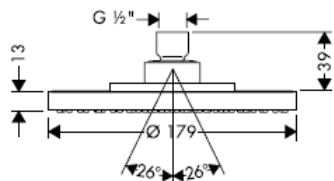

Terrano
28485XXX

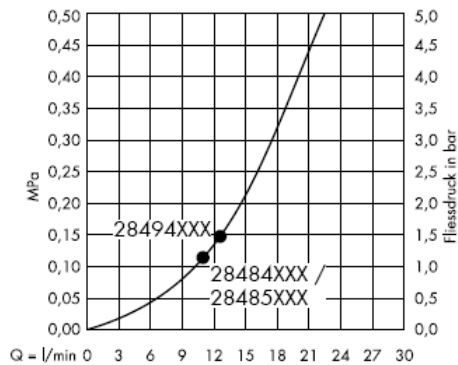
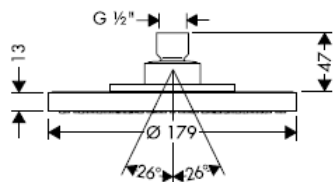

A • -től működik az adott funkció.

Starck/Steel/Uno Air
28494XXX

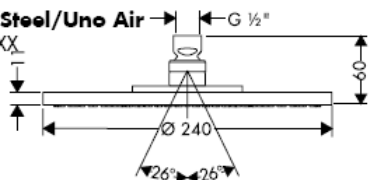

Szerelés

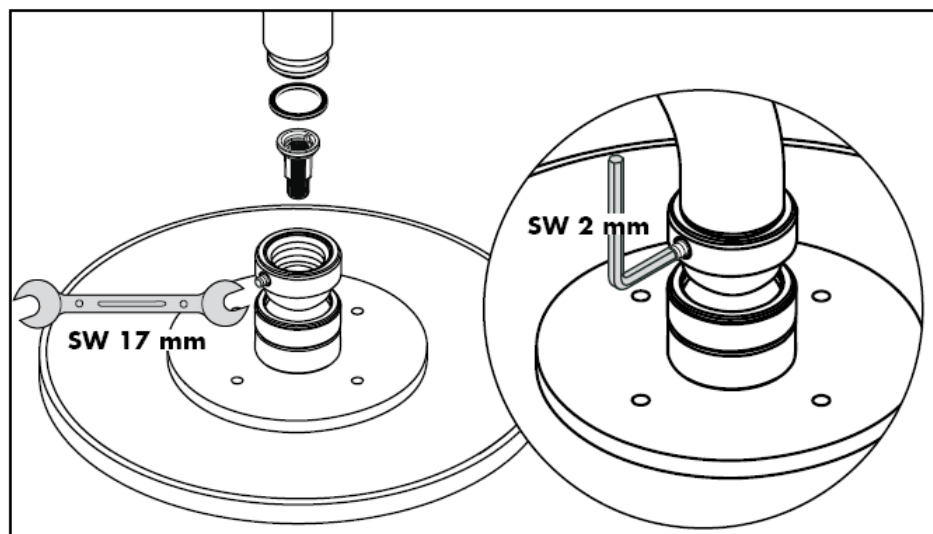

A kézi zuhanyhoz csomagolt szűrőtömítést be kell szerelni a vízhálózatból származó szennyeződések kiküszöbölésére. A beáramló szennyeződések akadályozhatják és / vagy teljesen tönkre is tehetik a zuhany funkcióit. Az ezekből adódó károkért a Hansgrohe nem felel.

Tisztítás

A Rubit® manuális tisztítófunkciónak köszönhetően a vízszugárnyílások egyszerű ledörzsöléssel megtisztíthatók a vízkőtől.

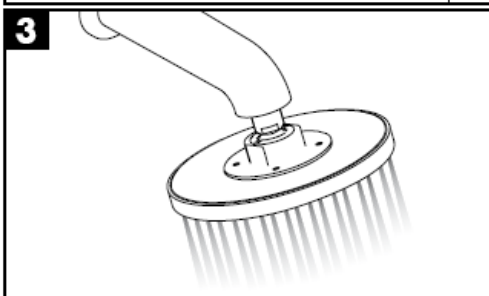
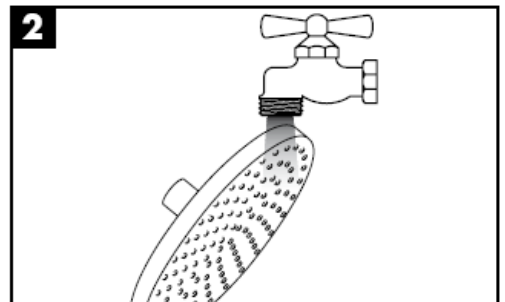
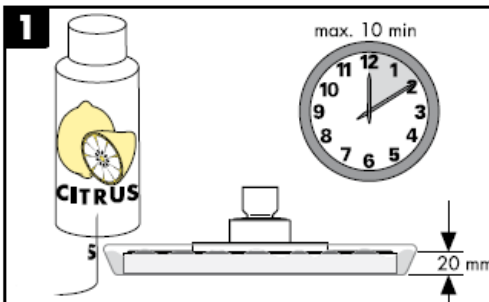
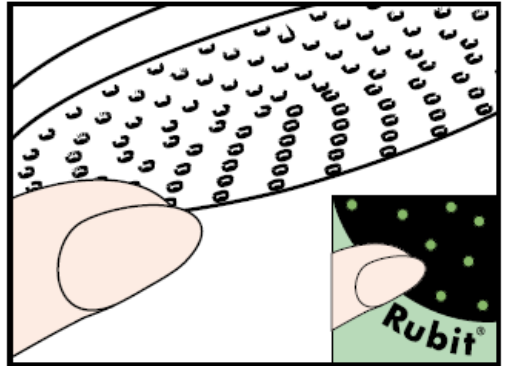

hansgrohe

Asennusohje

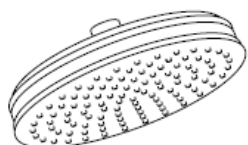

Carlton/Montreux
28474XXX/28487XXX

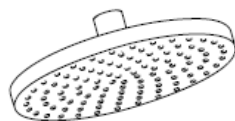

Terrano
28484XXX/28485XXX

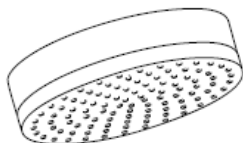

Citterio
28489000

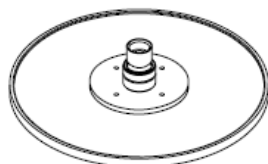

**Starck/Steel/Uno
Air**
28494XXX

AXOR[®]

hansgrohe

Hansgrohe käsisuihkuja voi käyttää hydraulisesti tai termisesti ohjattujen läpivirtauskuumentimien yhteydessä, jos virtauspaine ennen kalustetta on vähintään 0,15 MPa.

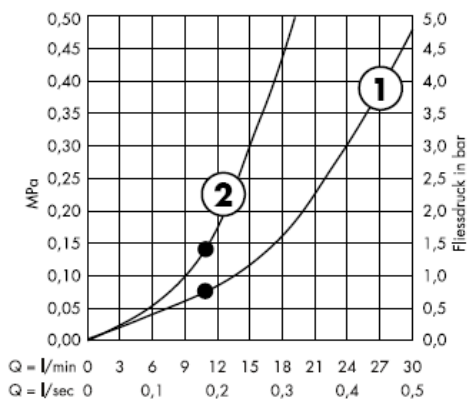

Tämä toiminta on taattuna • alkaen.

1 Normaalisuihku

Carlton / Montreux
28474XXX

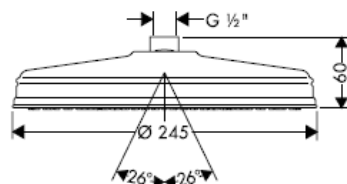

2 Normaalisuihku + Waterdimmer®
(virtauksenrajoitin)

Carlton / Montreux
28487XXX

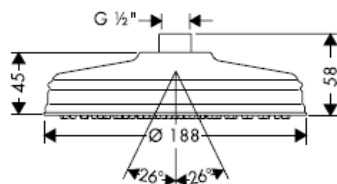

Citterio
28489000

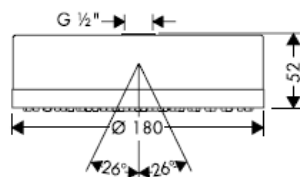

Asennus

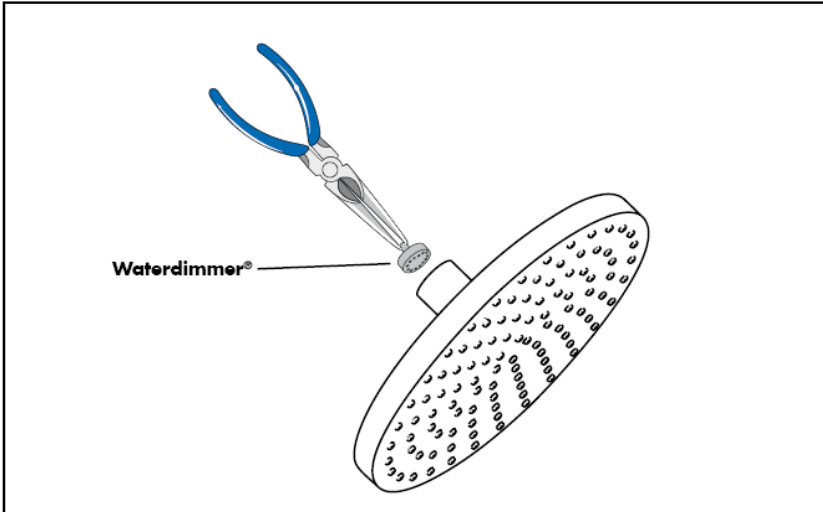
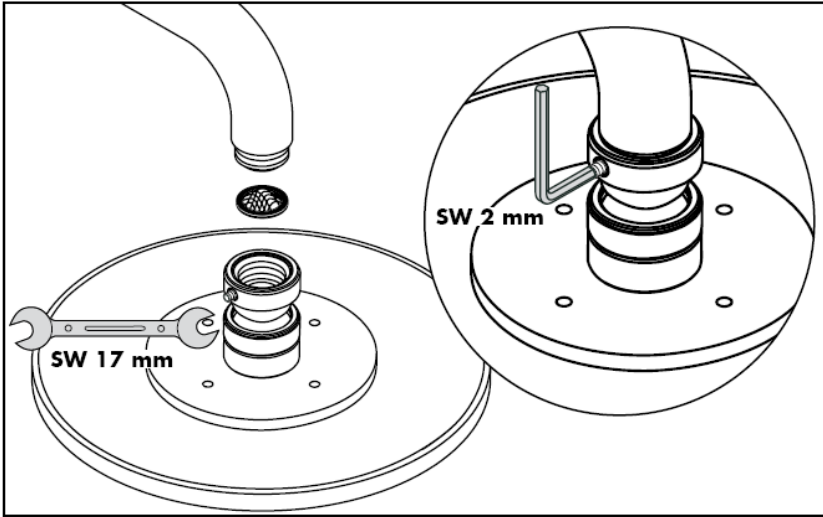

Käsisuihkun mukana toimitettu sihttiiviste on asennettava paikalleen, jotta lian huuhtoutuminen vesijohtoverkostosta käsisuihkuun estyy. Huuhtoutuvat likahiukkaset voivat häiritä suihkun toimintaa tai vahingoittaa toimintaosia, Hansgrohe ei vastaa tästä aiheutuneista vahingoista.

Terrano
28484XXX

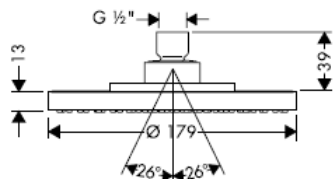

Terrano
28485XXX

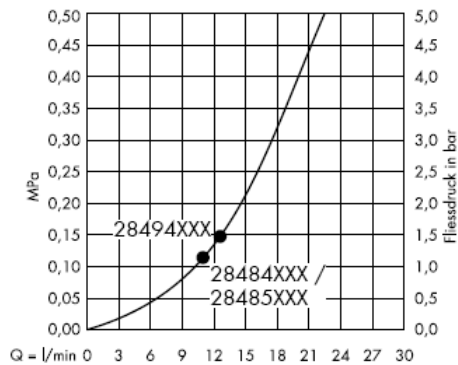
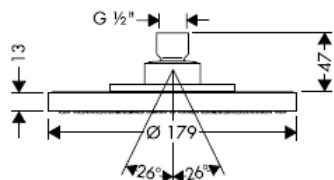

Tämä toiminta on taattuun • alkaen.

Starck/Steel/Uno Air
28494XXX

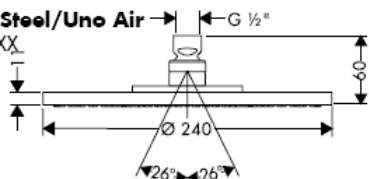

Asennus

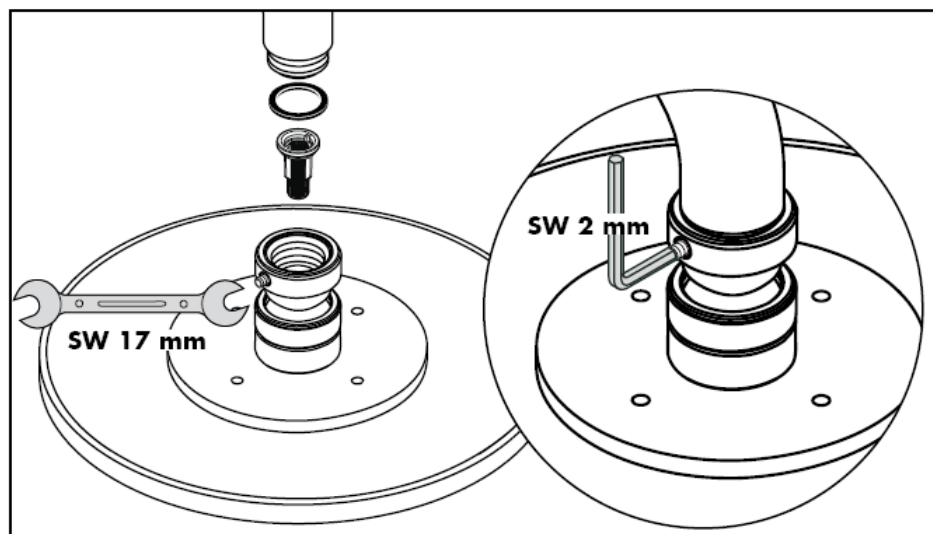

Käsisiuhkun mukana toimitettu sihtitiiviste on asennettava paikalleen, jotta lian huuhtoutuminen vesijohtoverkostosta käsisiuhkuun estyy. Huuhtoutuvat likahiukkaset voivat häiritä suihkun toimintaa tai vahingoittaa toimintaosia, Hansgrohe ei vastaa tästä aiheutuneista vahingoista.

Puhdistus

Rubit® –käsitoiminen kalkinpoistojärjestelmä on helppo käyttää: hiero sormella ja vedentulo on taas esteetön.

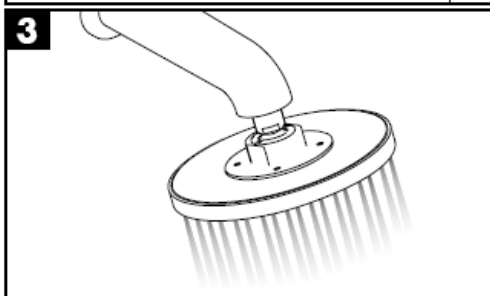
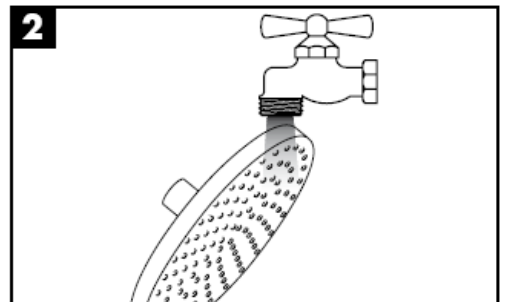
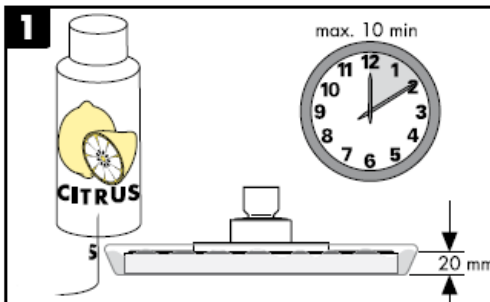
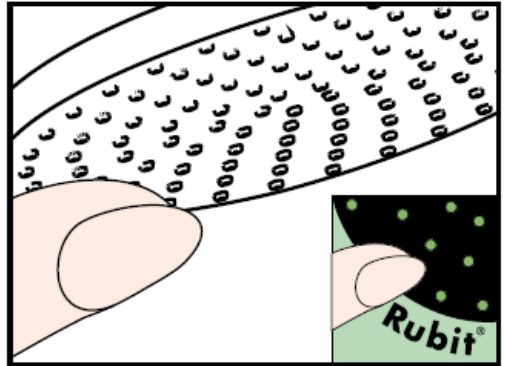

hansgrohe

Monteringsanvisning

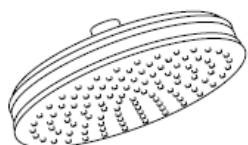

Carlton/Montreux
28474XXX/28487XXX

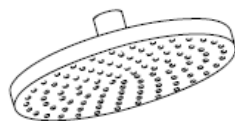

Terrano
28484XXX/28485XXX

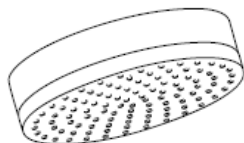

Citterio
28489000

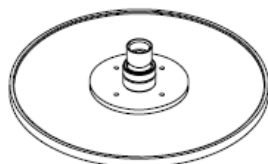

**Starck/Steel/Uno
Air**
28494XXX

AXOR[®]

hansgrohe

Hansgrohe duschar kan användas tillsammans med hydrauliskt och termiskt styrda varmvattenberedare när flödestrycket uppgår till minst 0,15 MPa framför blandaren.

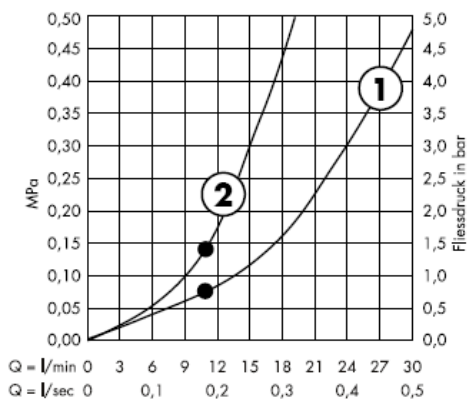

Från • garanteras funktionen.

1 Normalstråle

Carlton / Montreux
28474XXX

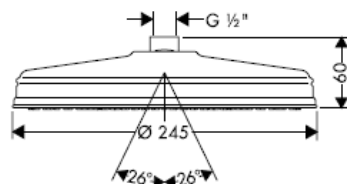

2 Normalstråle + Waterdimmer®
(flödeskontroll)

Carlton / Montreux
28487XXX

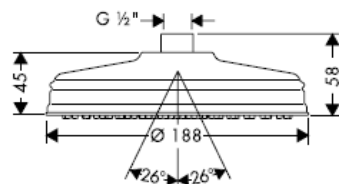

Citterio
28489000

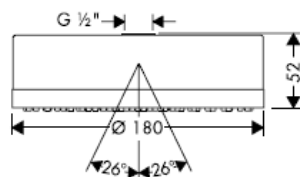

Montering

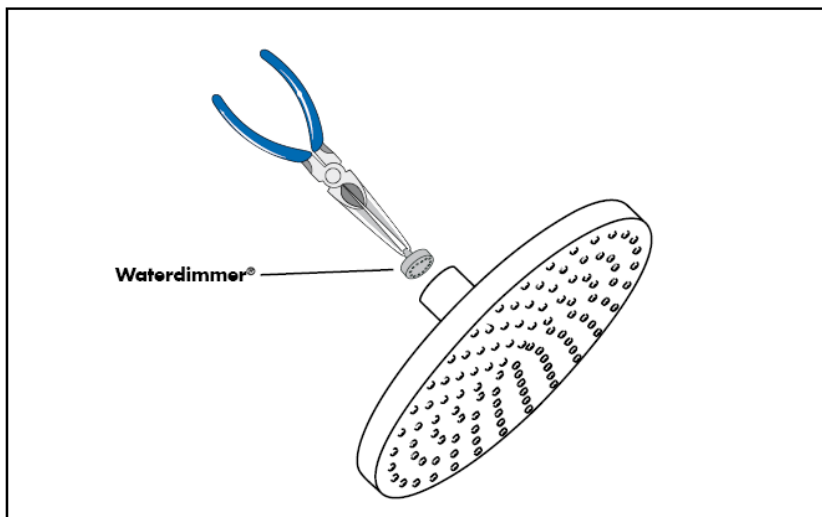
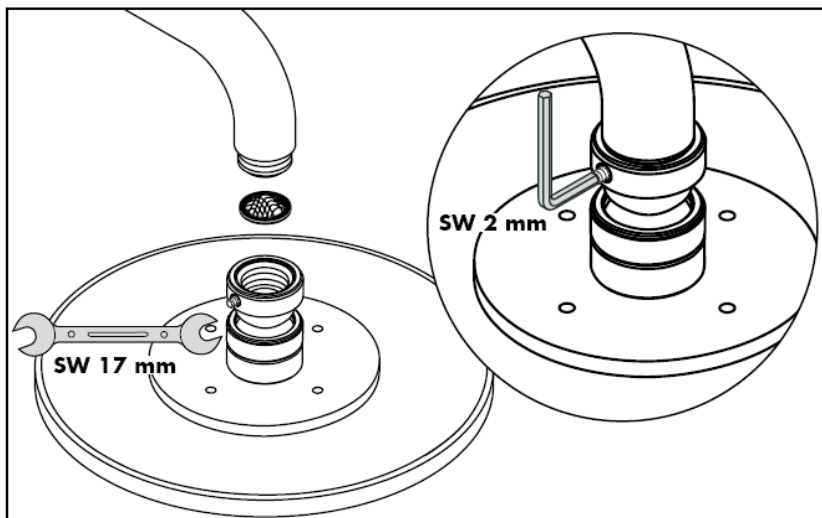

Silpackningen som följer med duschen måste monteras för att undvika att smuts från ledningsnätet tränger in. Smuts som spolas in kan påverka funktionerna och/eller leda till skador på funktionsdelar i duschen. Hansgrohe fränsäger sig allt ansvar för skador som kan härledas till detta.

Terrano
28484XXX

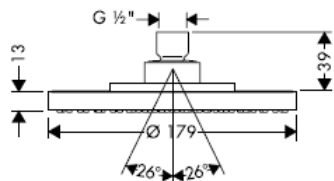

Terrano
28485XXX

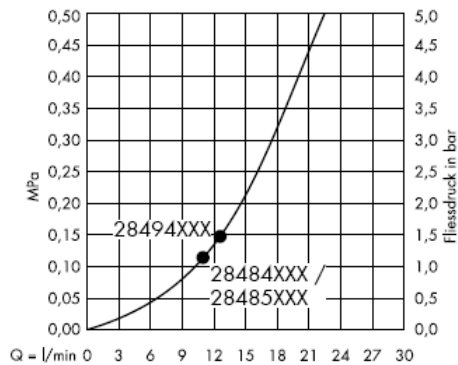
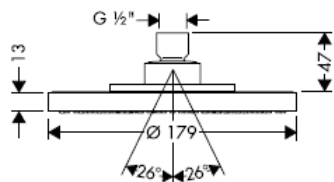

Från • garanteras funktionen.

Starck/Steel/Uno Air
28494XXX

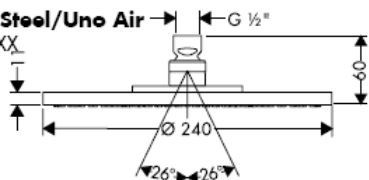

Montering

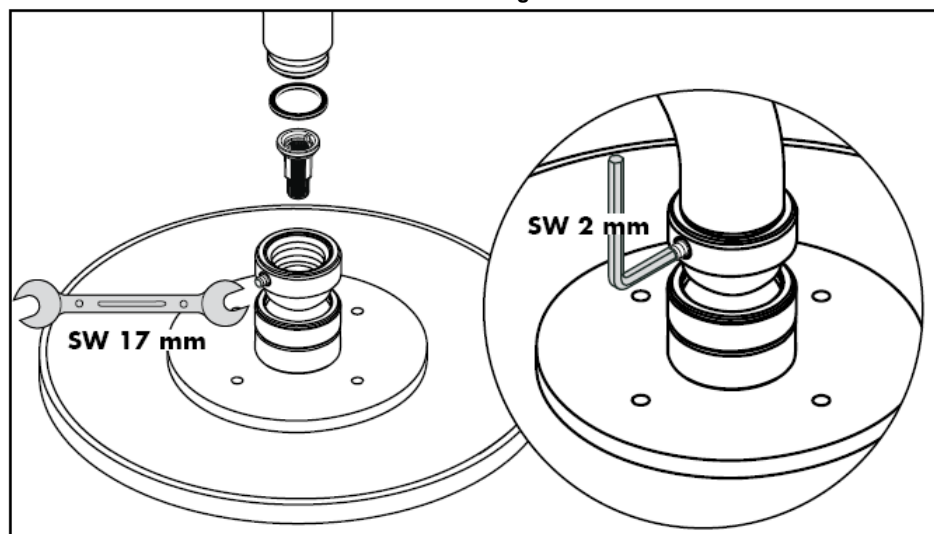

Silpackningen som följer med duschen måste monteras för att undvika att smuts från ledningsnätet tränger in. Smuts som spolas in kan påverka funktionerna och/eller leda till skador på funktionsdelar i duschen. Hansgrohe fransäger sig allt ansvar för skador som kan härledas till detta.

Rengöring

Med Rubit®, den manuella rengöringsfunktionen, är det lätt att befria strålkanelerna från kalk - de ska bar gnuggas.

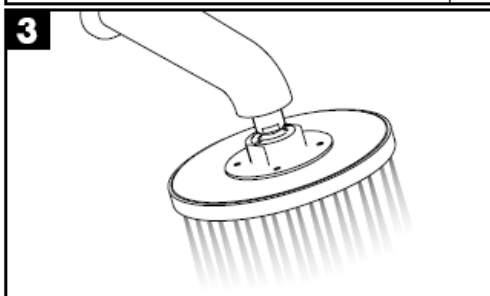
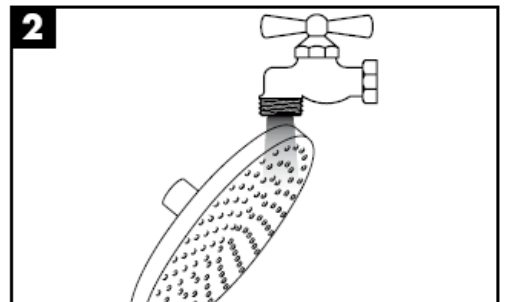
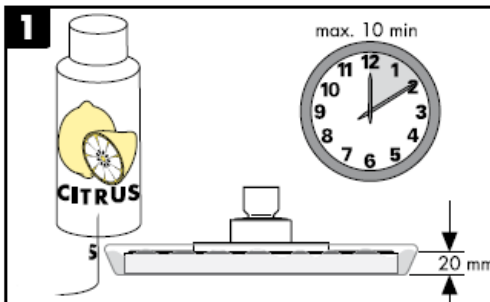
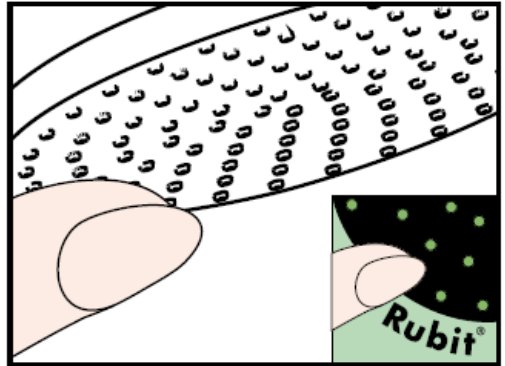

hansgrohe

Montavimo instrukcijos

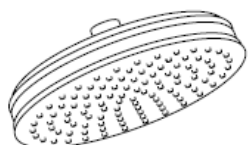

Carlton/Montreux
28474XXX/28487XXX

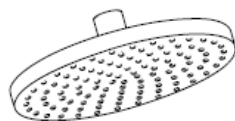

Terrano
28484XXX/28485XXX

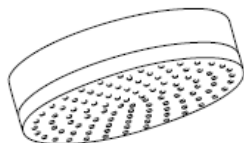

Citterio
28489000

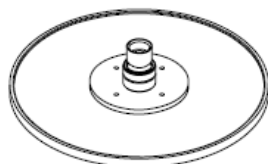

**Starck/Steel/Uno
Air**
28494XXX

AXOR[®]

hansgrohe

"Hansgrohe" stacionarios dušo galvos gali būti naudojami su hidrauliškai ir termiškai reguliuojamais momentiniais šildikliais, kai vandens slėgis mažesnis kaip 0,15 MPa.

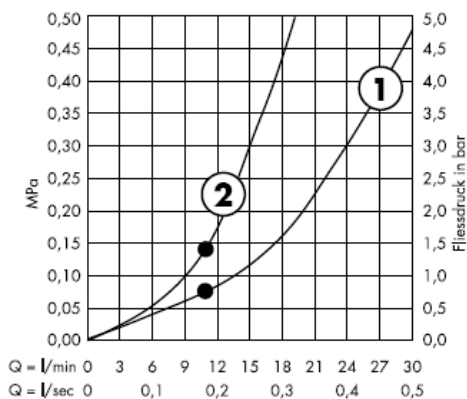

Nuo • funkcionavimas garantuotas

1 Normali srovė

Carlton / Montreux
28474XXX

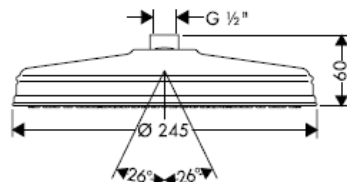

2 Normali srovė + "Waterdimmer®" (Vandens ribotuvas)

Carlton / Montreux
28487XXX

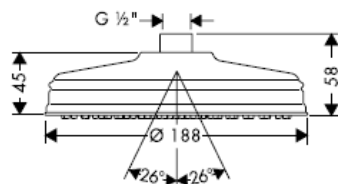

Citterio
28489000

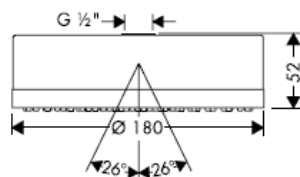

Montavimas

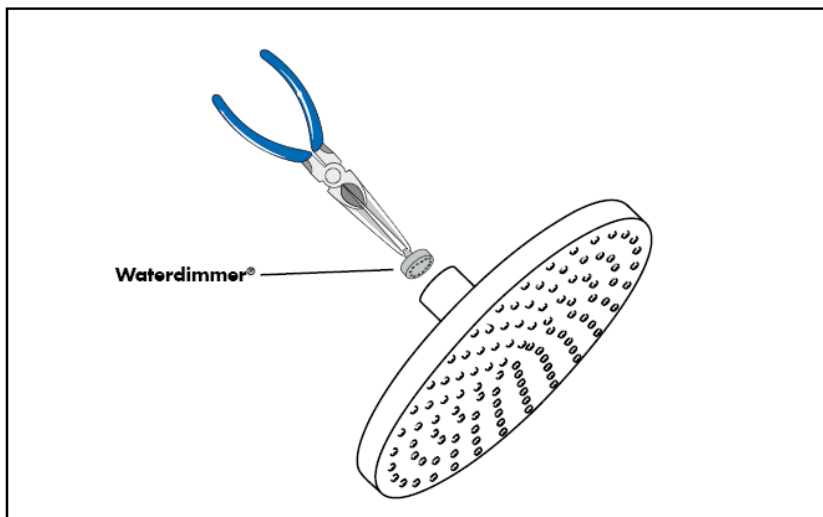
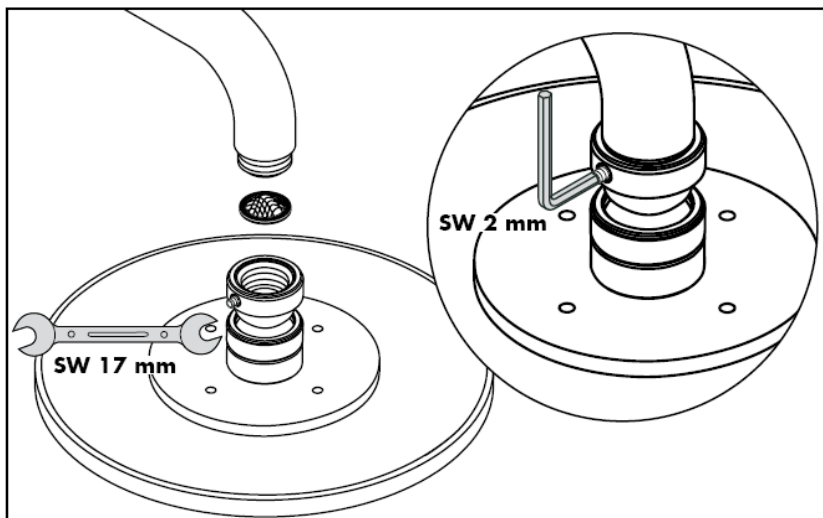

Tinklelis, kuris yra rankų dušas pakuotėje, privalo būti įstatytas, kad būtų apsaugota nuo išorės nešvarumų. Nešvarumai gali pakenkti rankų dušas funkcionalumui ir (arba) sugadinti rankų dušas funkcines dalis. Tokiu atveju "Hansgrohe" atsakomybės neprisiima.

Terrano
28484XXX

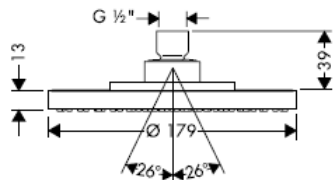

Terrano
28485XXX

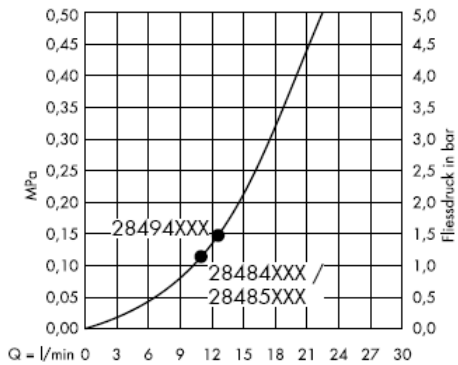
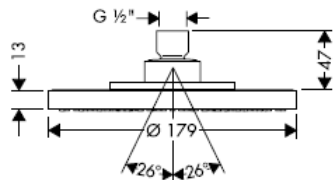

Nuo • funkcionavimas garantuotas

Starck/Steel/Uno Air
28494XXX

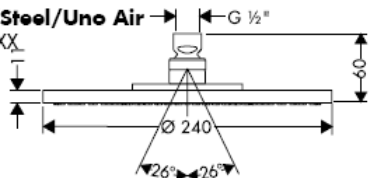

Montavimas

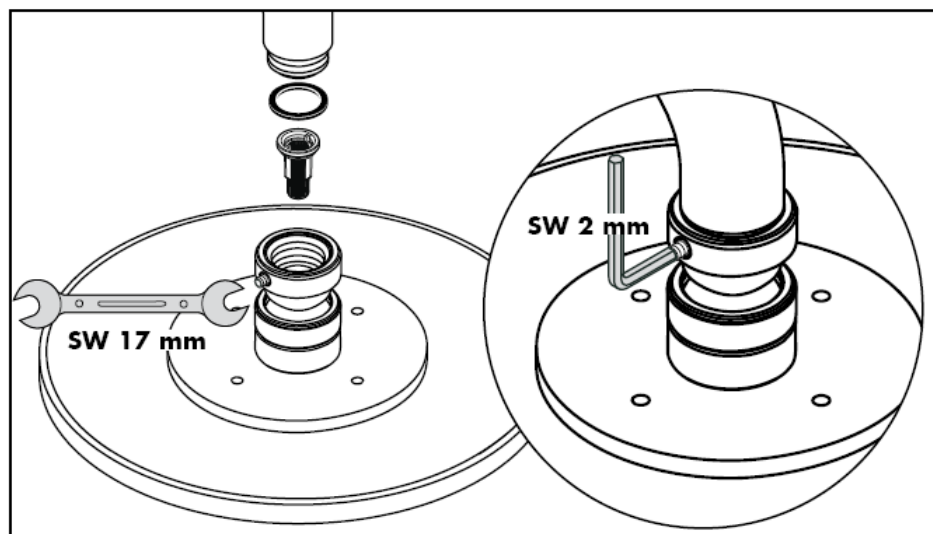

Tinklelis, kuris yra rankų dušas pakuotėje, privalo būti įstatytas, kad būtų apsaugota nuo išorės nešvarumų. Nešvarumai gali pakenkti rankų dušas funkcionalumui ir (arba) sugadinti rankų dušas funkcines dalis. Tokiu atveju "Hansgrohe" atsakomybės nepriima.

Valymas

"Rubit®" valymo funkcija apsaugo nuo apkalkėjimo. Užtenka pirštu nubraukti atsiradusius nešvarumus nuo srovės angų.

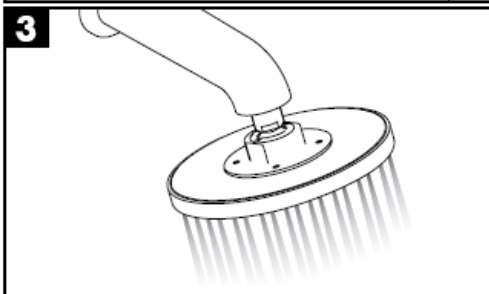
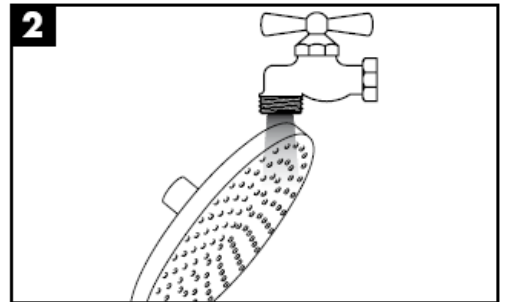
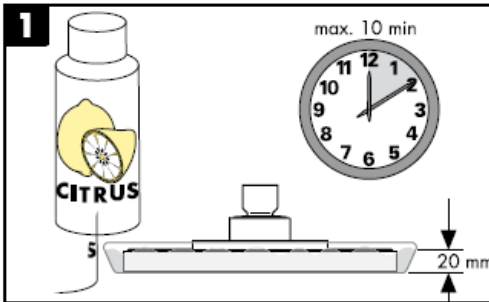
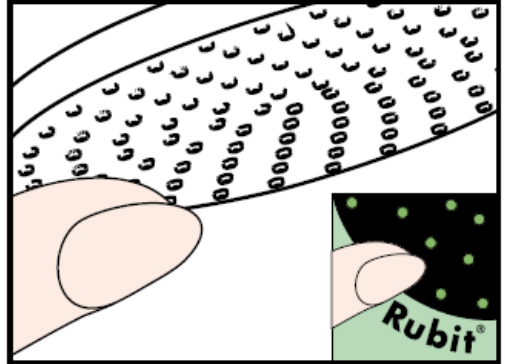

hansgrohe

Uputstva za instalaciju

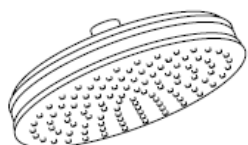

Carlton/Montreux
28474XXX/28487XXX

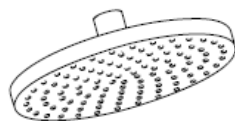

Terrano
28484XXX/28485XXX

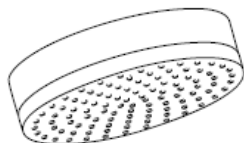

Citterio
28489000

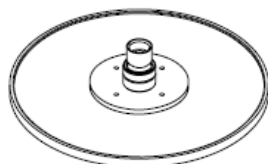

**Starck/Steel/Uno
Air**
28494XXX

AXOR[®]

hansgrohe

Hansgrohe tuševi mogu se koristiti u kombinaciji sa hidraulički i termički reguliranim protočnim bojlerima ukoliko tlak ispred armature iznosi najmanje 0,15 MPa.

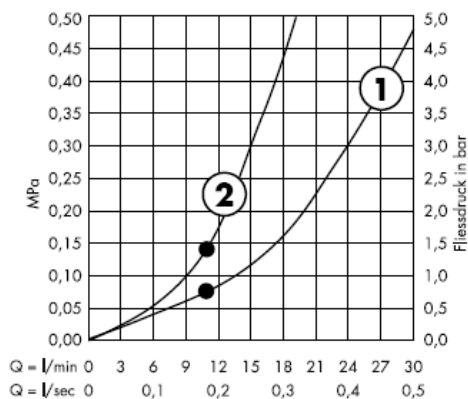

Zajamčena funkcija od • naviše

1 Normalni mlaz

Carlton / Montreux
28474XXX

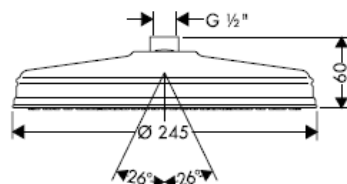

2 Normalni mlaz + Waterdimmer (ograničavač protoka)

Carlton / Montreux
28487XXX

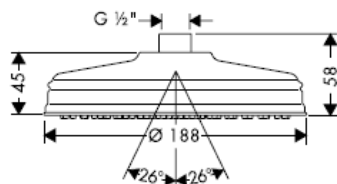

Citterio
28489000

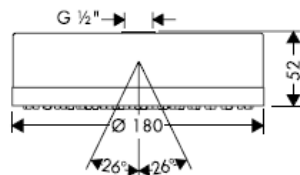

Sastavljanje

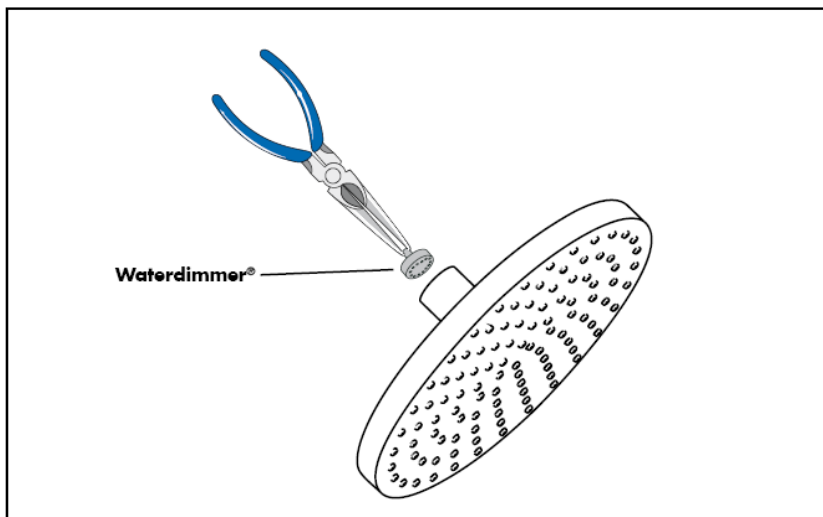
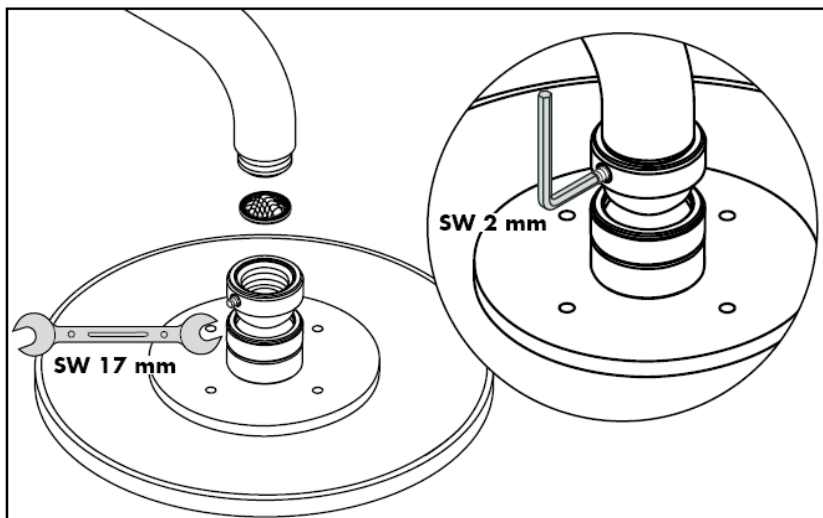

Filter (A) potrebno je ugraditi kako bi se regulirao protok vode i smanjio dotok prljavštine . Ako želite jači protok vode umjesto filtera ugradite rešetku (B) Za eventualna oštećenja uzrokovana prljavštinom proizvođač Hansgrohe nije odgovoran.

Terrano
28484XXX

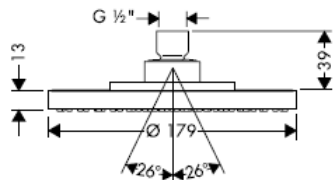

Terrano
28485XXX

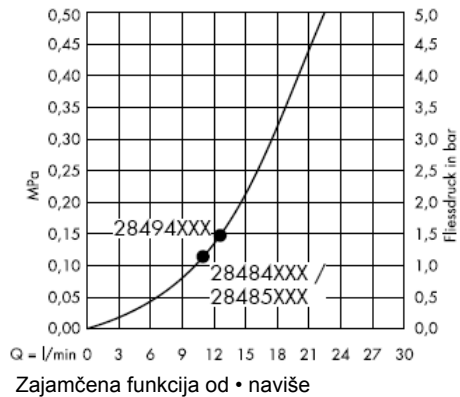
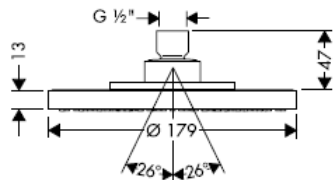

Starck/Steel/Uno Air
28494XXX

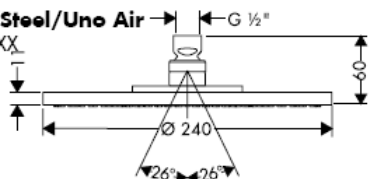

Sastavljanje

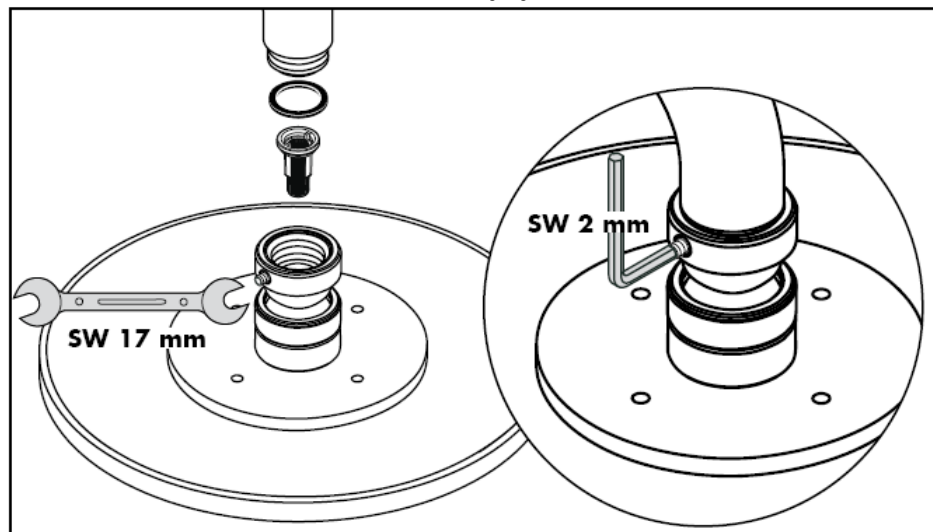

Tuš je prikladan za uporabu u kombinaciji sa elektroničkim protočnim bojlerom.

Čišćenje

Rubit® - ručni sustav za čišćenje omogućuje jednostavnim trljanjem odstranjanje kamenca sa rupica prskalice tuša.

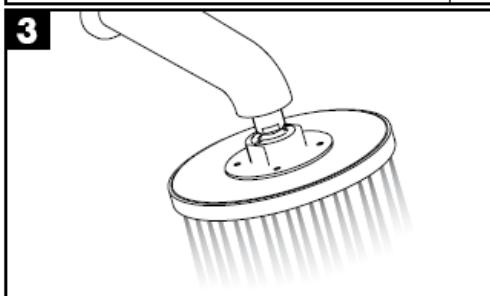
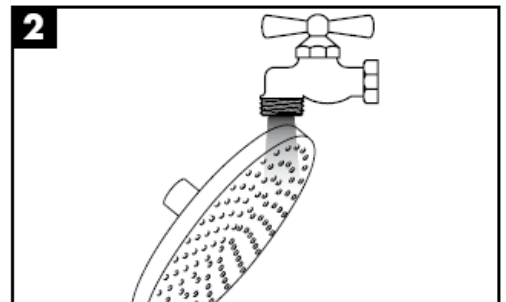
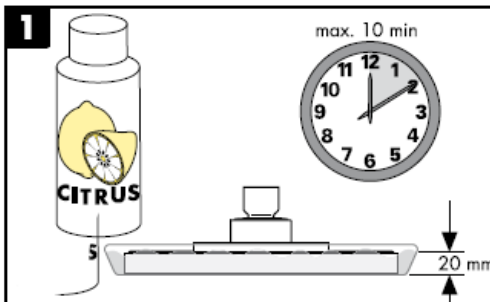
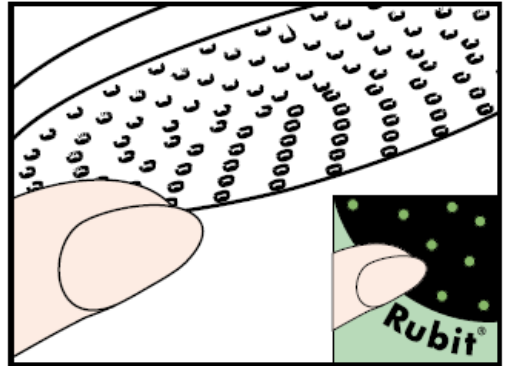

hansgrohe

Montaj kılavuzu

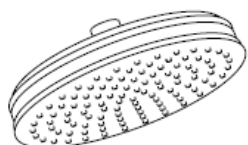

Carlton/Montreux
28474XXX/28487XXX

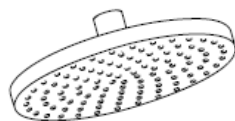

Terrano
28484XXX/28485XXX

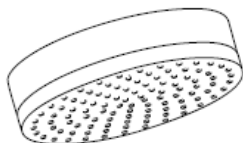

Citterio
28489000

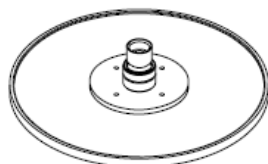

**Starck/Steel/Uno
Air**
28494XXX

AXOR[®]

hansgrohe

Hansgrohe bataryaları, bataryanın önündeki akış basıncı en az 0,15 MPa olursa hidrolik ve termik kumandalı şofbenlerle bağlantılı olarak kullanılabilir.

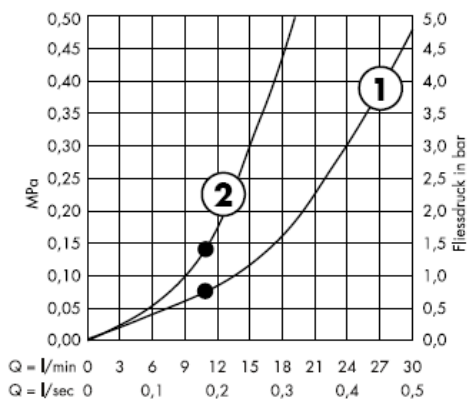

•den itibaren fonksiyon garanti edilmiştir.

① Normal duş

Carlton / Montreux
28474XXX

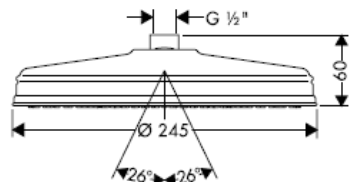

② Normal su akışı + Waterdimmer® (akış sınırlayıcı)

Carlton / Montreux
28487XXX

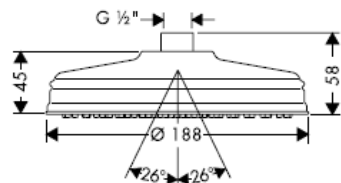

Citterio
28489000

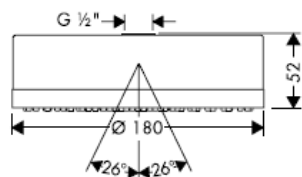

Montajı

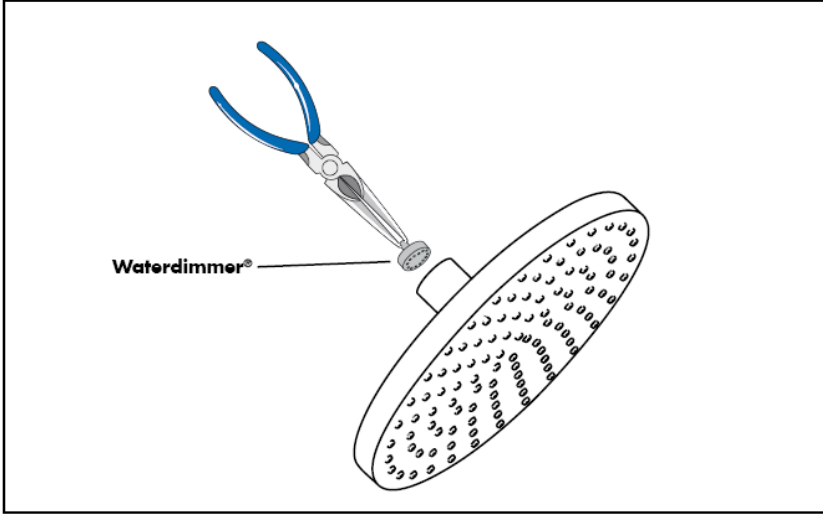
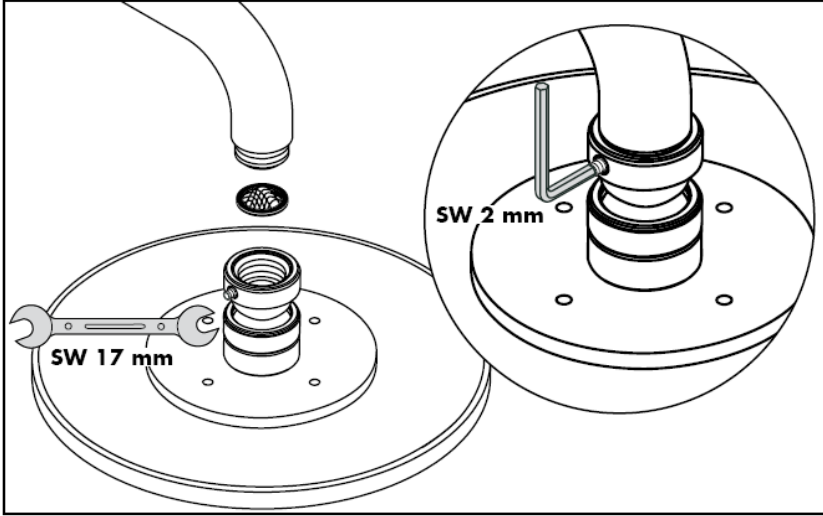

El duşu kafasına eklenmiş olan süzgeç contası, boru şebekesinden sızan kirlerin önüne geçmek için, yerine monte edilmelidir. İçeri sızan bu kirler duşun fonksiyonunu sekteleyebilir ve/veya duşun fonksiyon parçaları üzerinde hasarlara sebep olabilir, bu yüzden meydana gelen hasarlardan Hansgrohe sorumlu tutulamaz.

Terrano
28484XXX

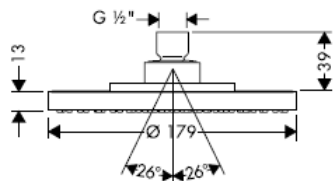

Terrano
28485XXX

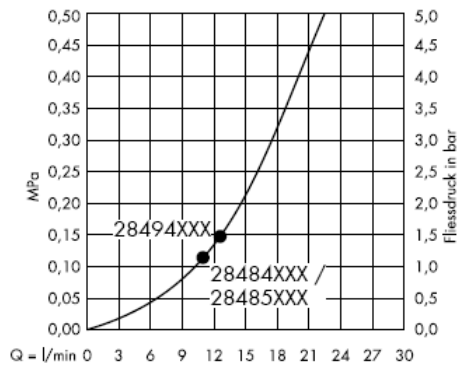
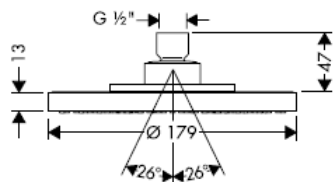

•den itibaren fonksiyon garanti edilmiştir.

Starck/Steel/Uno Air
28494XXX

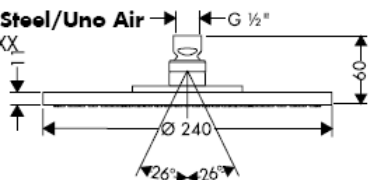

Montajı

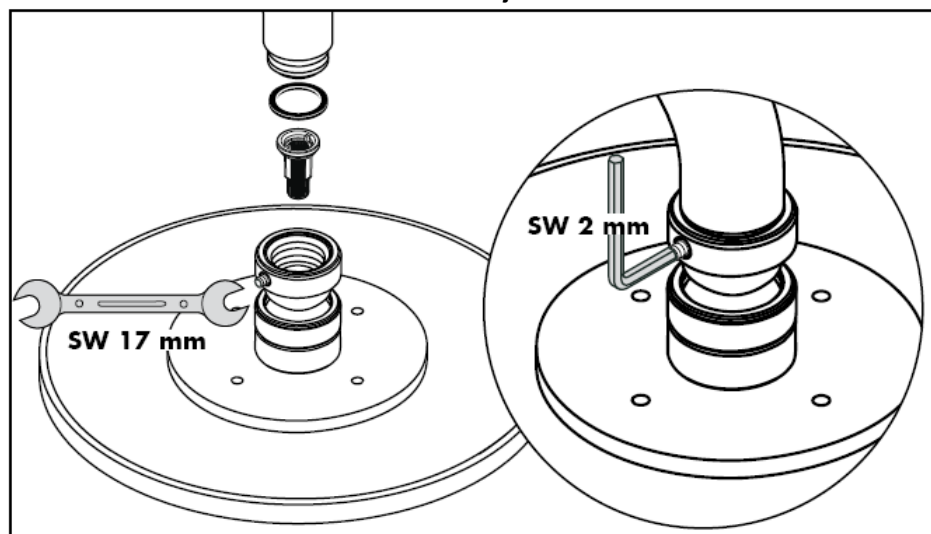

El duđu kafasına eklenmiř olan süzgeç contası, boru řebekesinden sızan kirlerin önüne geçmek için, yerine monte edilmelidir. İçeri sızan bu kirler duđun fonksiyonunu sekteleyebilir ve/veya duđun fonksiyon parçaları üzerinde hasarlara sebep olabilir, bu yüzden meydana gelen hasarlardan Hansgrohe sorumlu tutulamaz.

Temizleme

Rubit®, üründe bulunan bir temizleme fonksiyonudur. Basit bir ovuşturma ile spray modüllerdeki kireci çözer.

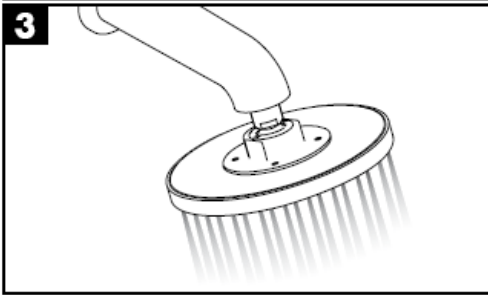
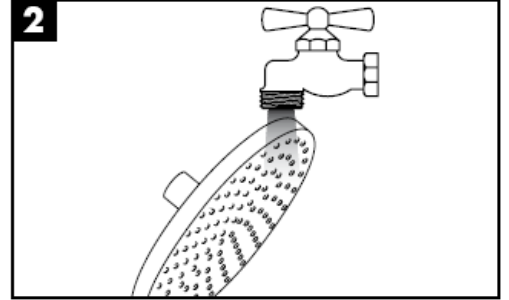
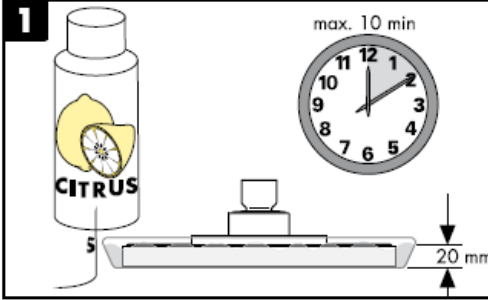
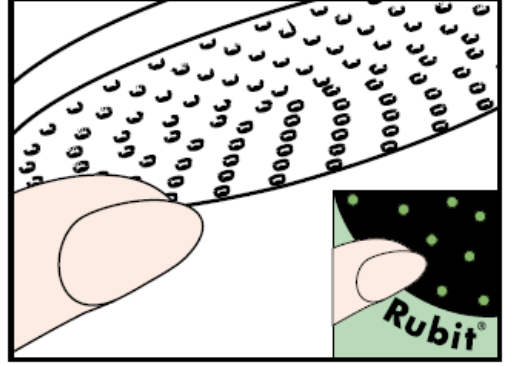

hansgrohe

Instrucțiuni de montare

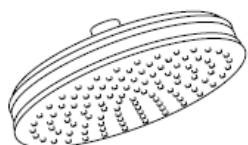

Carlton/Montreux
28474XXX/28487XXX

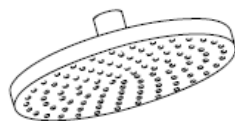

Terrano
28484XXX/28485XXX

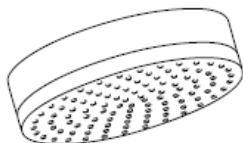

Citterio
28489000

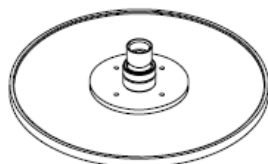

**Starck/Steel/Uno
Air**
28494XXX

AXOR[®]

hansgrohe

Capetele de duș Hansgrohe pot fi utilizate cu boiler instant cu comandă termică sau hidraulică dacă presiunea apei de alimentare înainte de baterie este de min. 0,15 MPa.

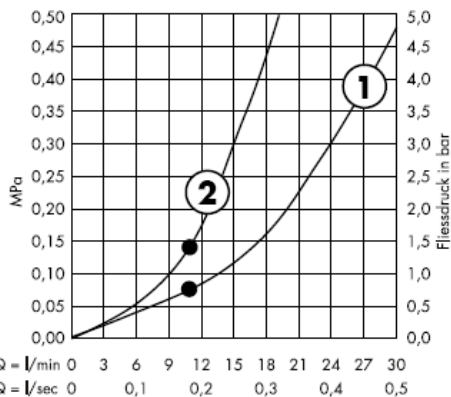

Începând de la • funcționarea este garantată.

1 jet normal

Carlton / Montreux
28474XXX

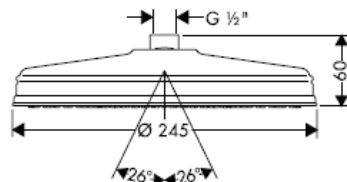

2 jet normal + Waterdimmer® (reductor de debit)

Carlton / Montreux
28487XXX

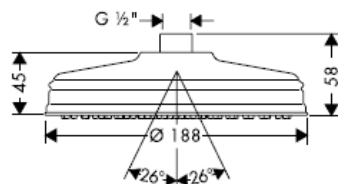

Citterio
28489000

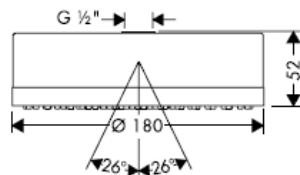

Montare

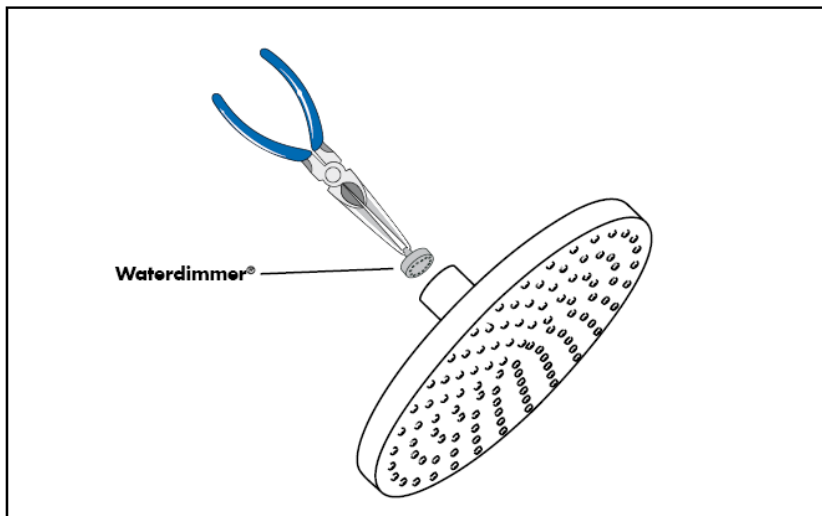
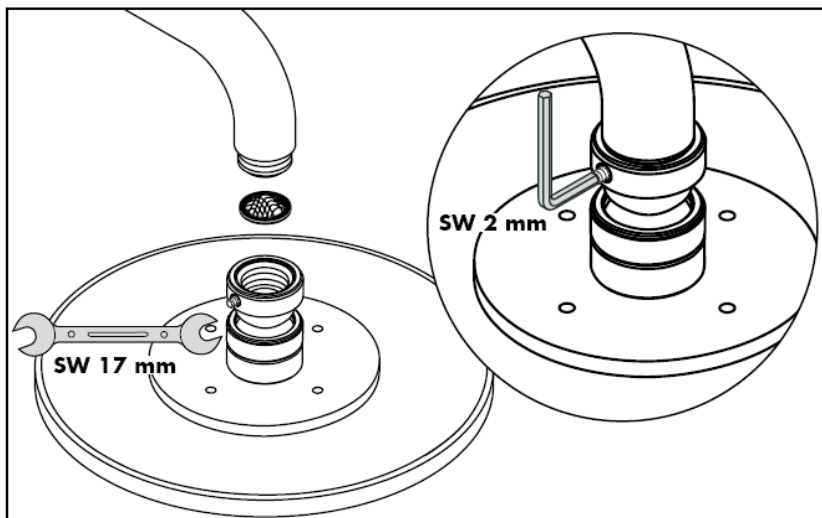

Montați garnitura de filtru livrată împreună cu capătul de duș de mână pentru evitarea pătrunderii impurităților din rețeaua de alimentare. Impuritățile pătrunse pot influența funcționarea aparatului și/sau provoca deteriorarea capătului de duș. Garanția nu acoperă aceste daune.

Terrano
28484XXX

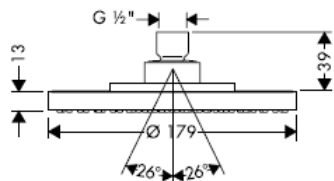

Terrano
28485XXX

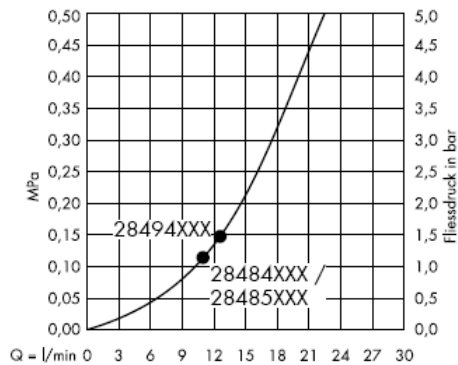
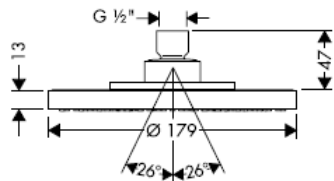

Începând de la • funcționarea este garantată.

Starck/Steel/Uno Air
28494XXX

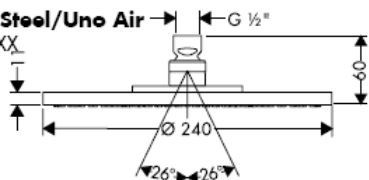

Montare

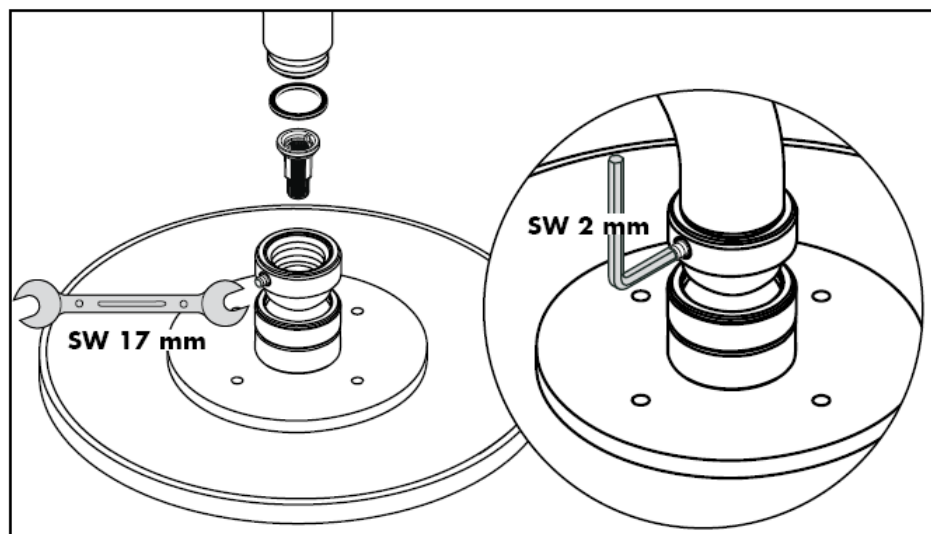

Montați garnitura de filtru livrată împreună cu capătul de duș de mână pentru evitarea pătrunderii impurităților din rețeaua de alimentare. Impuritățile pătrunse pot influența funcționarea aparatului și/sau provoca deteriorarea capătului de duș. Garanția nu acoperă aceste daune.

Curățare

Cu ajutorul sistemului Rubit® puteți să îndepărtați depunerile de calcar de pe diferitele duze de jet de apă prin frecare.

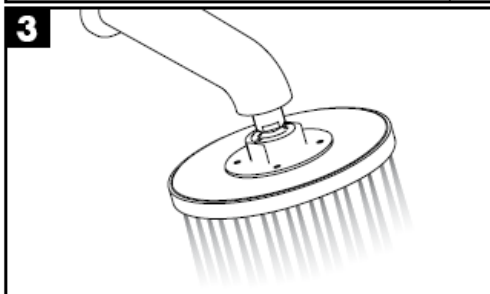
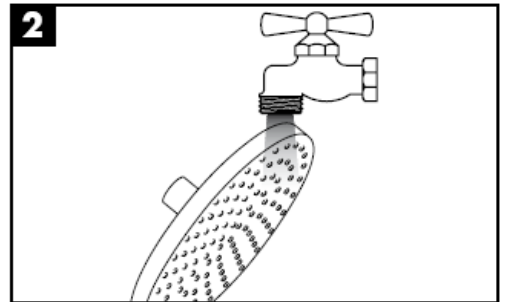
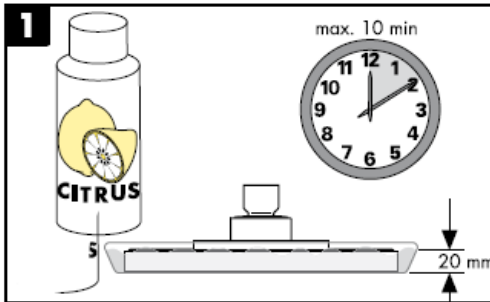
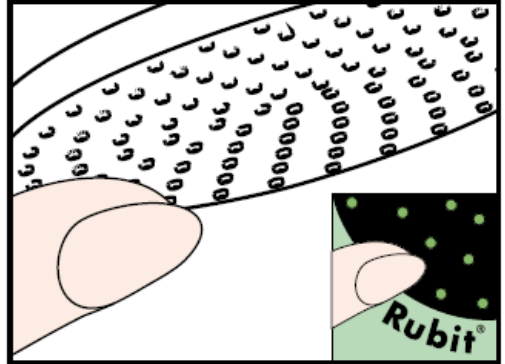

hansgrohe

Οδηγία συναρμολόγησης

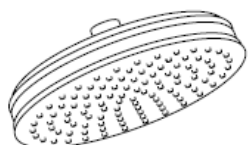

Carlton/Montreux
28474XXX/28487XXX

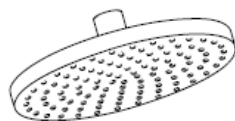

Terrano
28484XXX/28485XXX

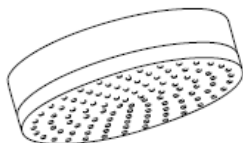

Citterio
28489000

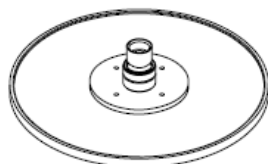

**Starck/Steel/Uno
Air**
28494XXX

AXOR[®]

hansgrohe

Οι καταιονιστήρες Hansgrohe μπορούν να συνδυαστούν με ταχυθερμοσίφωνες υδραυλικού και θερμικού ελέγχου, όταν η πίεση ροής της βάνας αριθμεί τουλάχιστον 0,15 MPa.

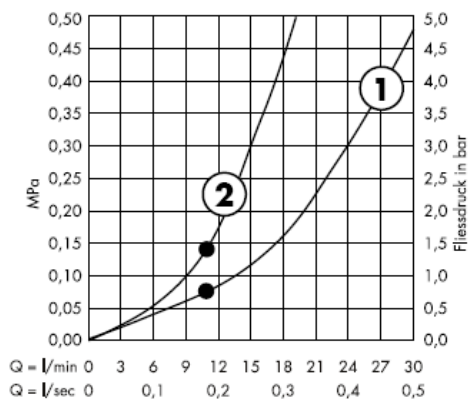

Αυτή η λειτουργία διασφαλίζεται από το σημείο κι έπειτα

1 Κανονική δέσμη νερού

Carlton / Montreux
28474XXX

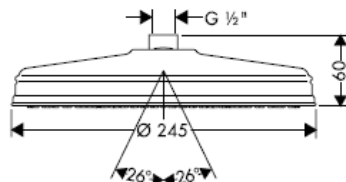

2 Κανονική δέσμη νερού + ελαχιστοποιητής νερού (Waterdimmer®) (περιοριστική διάταξη ροής)

Carlton / Montreux
28487XXX

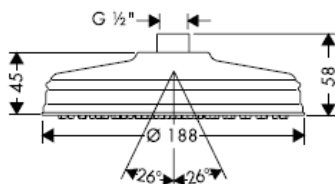

Citterio
28489000

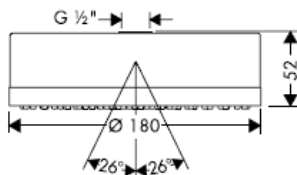

Συναρμολόγηση

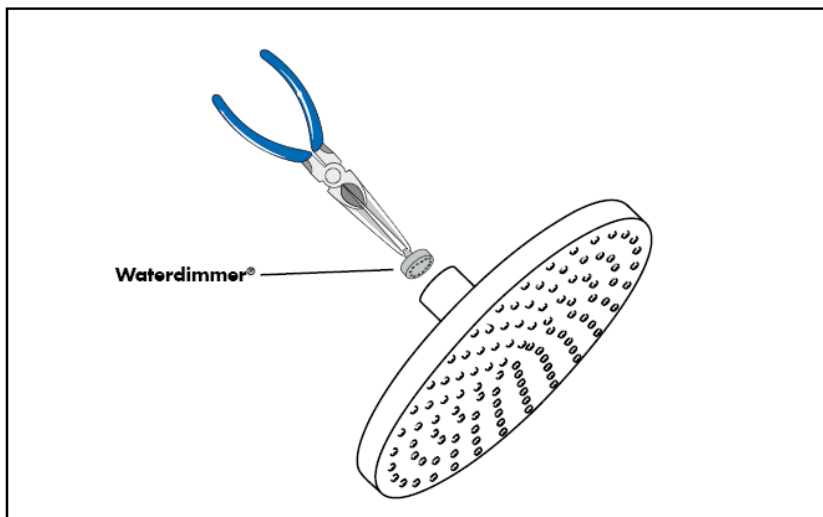
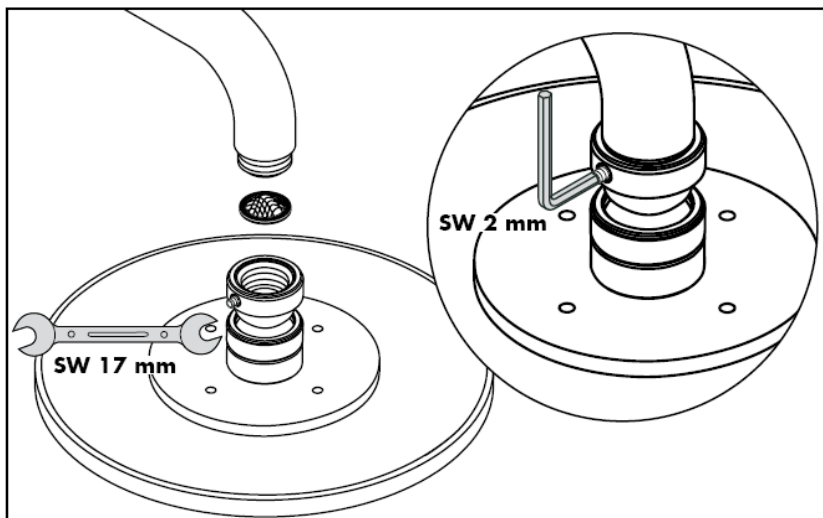

Πρέπει να εγκατασταθεί το παρέμβυσμα φίλτρου που συνοδεύει τον καταιονιστήρα κατά τέτοιο τρόπο, ώστε να αποφεύγονται ρύποι που προέρχονται από το δίκτυο ύδρευσης. Οι ρύποι από το δίκτυο ύδρευσης μπορούν να επηρεάσουν αρνητικά και/ ή να προξενήσουν ζημιά στα λειτουργικά τμήματα του καταιονιστήρα (ντους). Τέτοιου είδους ζημίες δεν καλύπτονται από την εγγύηση Hansgrohe.

Terrano
28484XXX

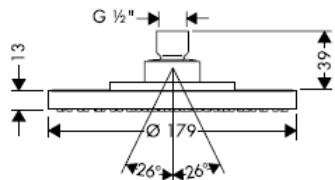

Terrano
28485XXX

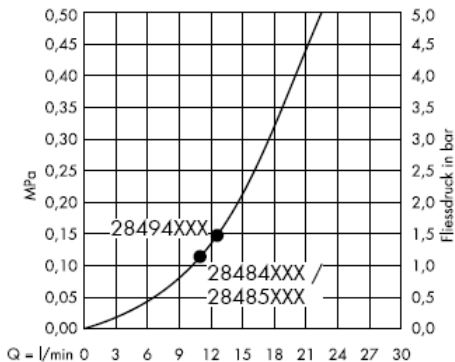
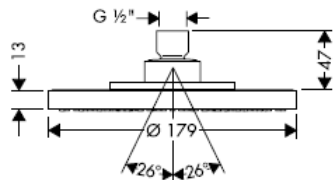

Αυτή η λειτουργία διασφαλίζεται από το σημείο κι έπειτα

Starck/Steel/Uno Air
28494XXX

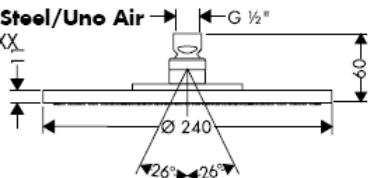

Συναρμολόγηση

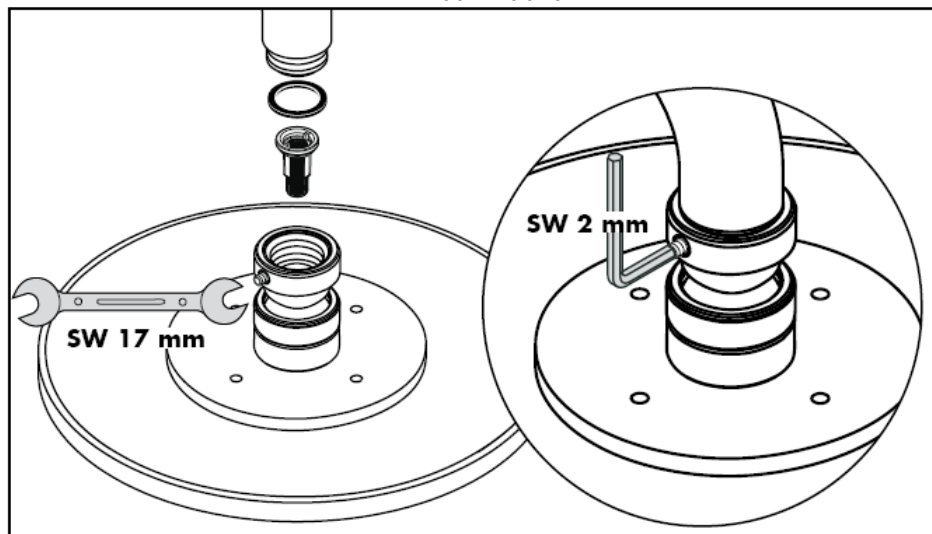

Πρέπει να εγκατασταθεί το παρέμβυσμα φίλτρου που συνοδεύει τον καταιονιστήρα κατά τέτοιο τρόπο, ώστε να αποφεύγονται ρύποι που προέρχονται από το δίκτυο ύδρευσης. Οι ρύποι από το δίκτυο ύδρευσης μπορούν να επηρεάσουν αρνητικά και/ ή να προξενήσουν ζημιά στα λειτουργικά τμήματα του καταιονιστήρα (ντους). Τέτοιου είδους ζημιές δεν καλύπτονται από την εγγύηση Hansgrohe.

Καθαρισμός

Με Rubit®, τη λειτουργία καθαρισμού με το χέρι, μπορούν να απομακρυνθούν με απλό τρίψιμο τα άλατα από τα κανάλια του καταιονιστήρα.

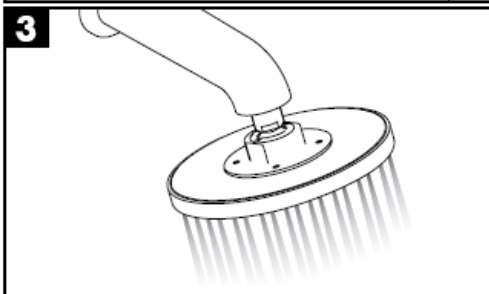
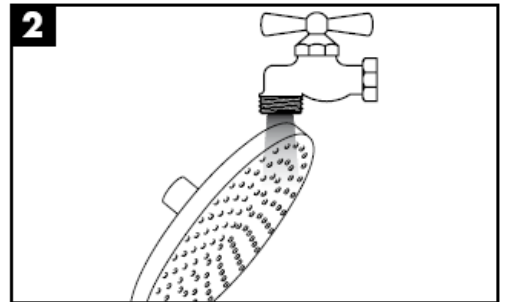
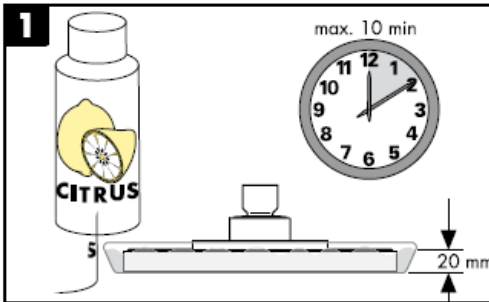
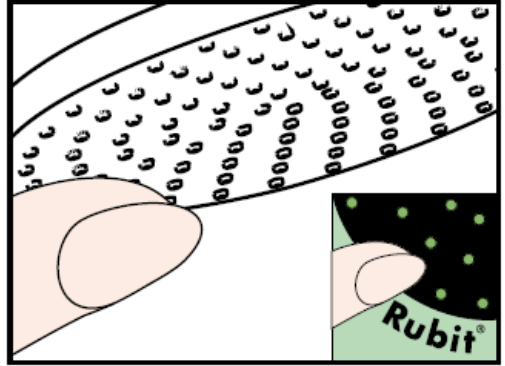

hansgrohe

تعليمات التجميع

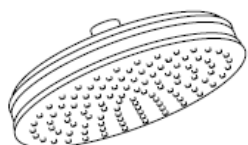

Carlton/Montreux
28474XXX/28487XXX

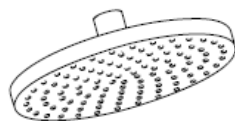

Terrano
28484XXX/28485XXX

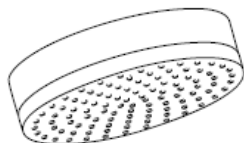

Citterio
28489000

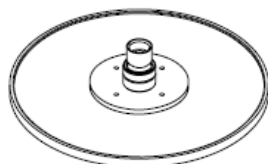

**Starck/Steel/Uno
Air**
28494XXX

AXOR[®]

hansgrohe

يمكن استخدام دش هانزجروهه مع سخانات تدفق الماء ذات التحكم الهيدروليكي أو الحراري، مع ضغط تدفق لا يقل عن 1.5 بار.

من • الوظيفة مضمونة.

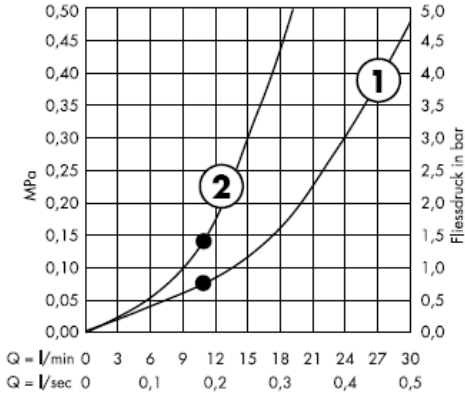

①

رشاش عادي

Carlton / Montreux
28474XXX

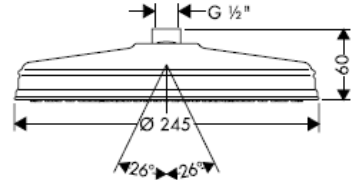

②

رشاش عادي + محدد التدفق Waterdimmer®

Carlton / Montreux
28487XXX

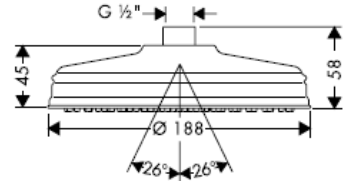

Citterio
28489000

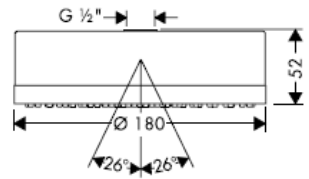

التركيب

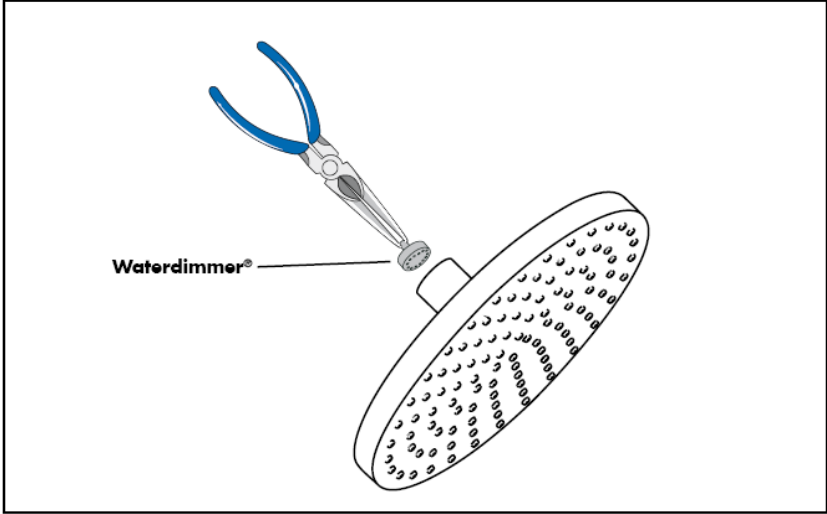
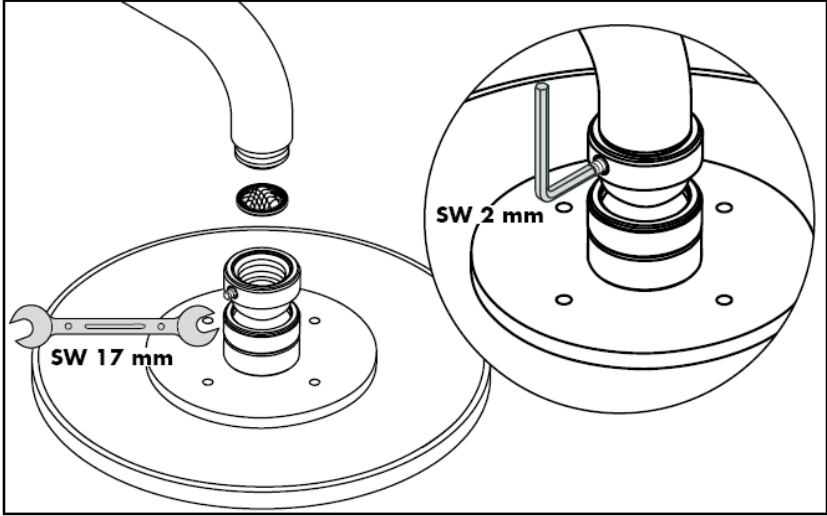

يجب إدخال الحلقة الشبكية لحماية الدش اليدوي من الأوساخ التي تحملها شبكة المواسير. حيث تؤدي الأوساخ الواردة إلى حدوث أعطال أو / وقد تتسبب في تلف أجزاء من من الدش، ومثل هذه الأعطال تلغي كافة المطالبات الخاصة بالمسؤولية أو الضمان.

Terrano
28484XXX

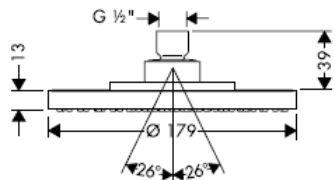

Terrano
28485XXX

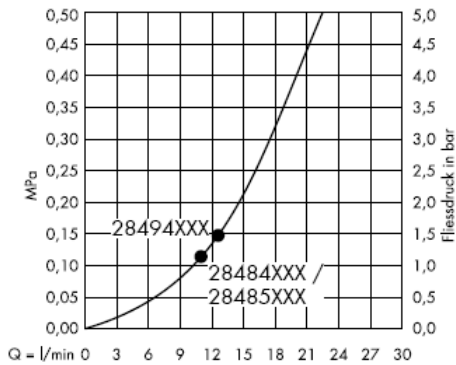
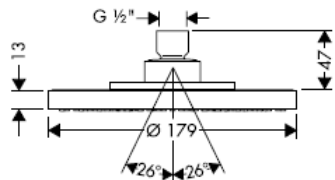

من • الوظيفة مضمونة.

Starck/Steel/Uno Air
28494XXX

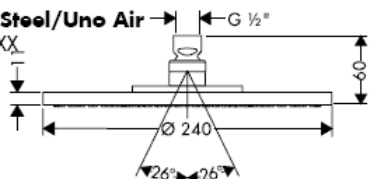

التركيب

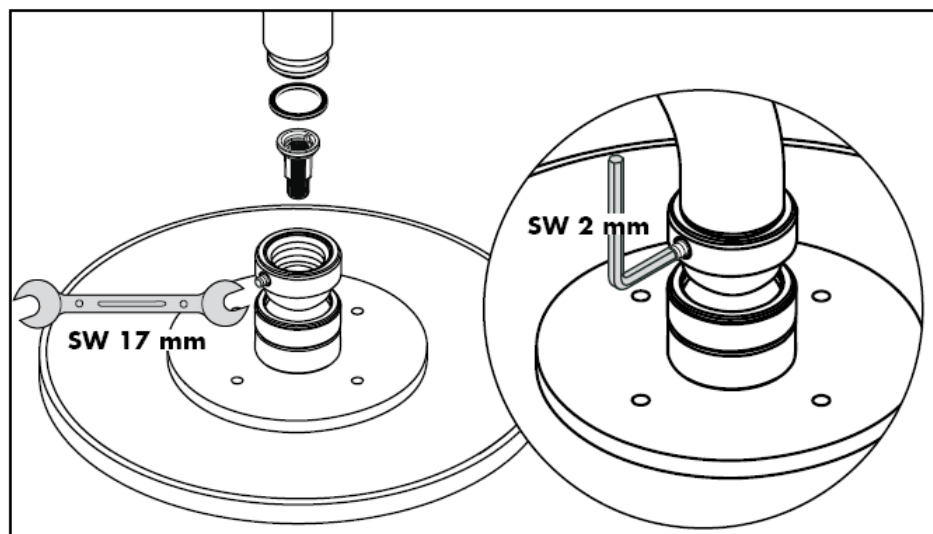

يجب إدخال الحلقة الشبكية لحماية الدش اليدوي من الأوساخ التي تحملها شبكة المواسير. حيث تؤدي الأوساخ الواردة إلى حدوث أعطال أو / و قد تتسبب في تلف أجزاء من من الدش، ومثل هذه الأعطال تلغي كافة المطالبات الخاصة بالمسؤولية أو الضمان.

التنظيف

لا تحتاج وظيفة تنظيف سوى قدر بسيط من الفرك باليد لإزالة القشور الجيرية من قنوات الرشاش.

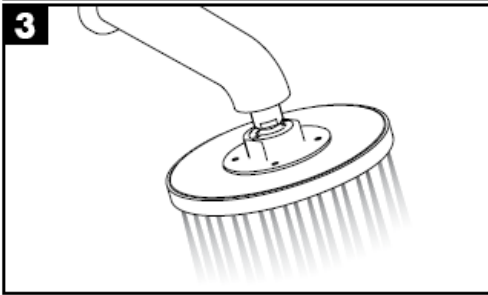
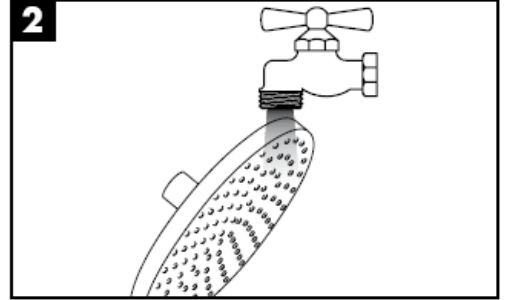
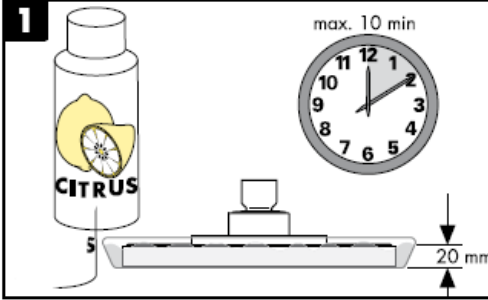
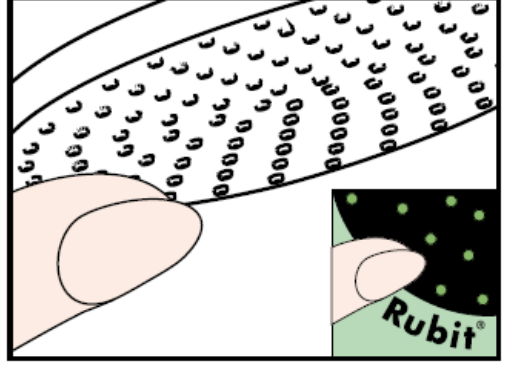

hansgrohe

Hansgrohe · Postfach 1145 · D-77761 Schiltach · Telefon +49 (0) 78 36/51-1282 · Telefax +49 (0) 7836/511440
E-Mail: info@hansgrohe.com · Internet: www.hansgrohe.com

11/2007
9.08534.08

عربي

Navodila za montažo

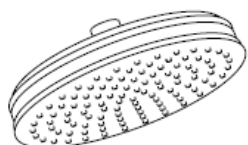

Carlton/Montreux
28474XXX/28487XXX

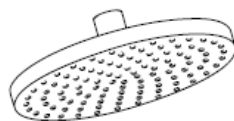

Terrano
28484XXX/28485XXX

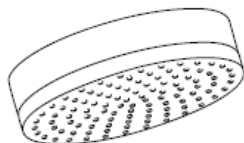

Citterio
28489000

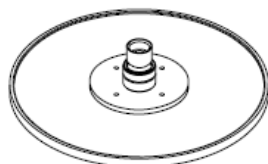

**Starck/Steel/Uno
Air**
28494XXX

AXOR[®]

hansgrohe

Prhe Hansgrohe lahko uporabljate v povezavi s hidravlično in termično uravnavanimi pretočnimi grelniki, če je pretočni tlak pred armaturo najmanj 0,15 MPa.

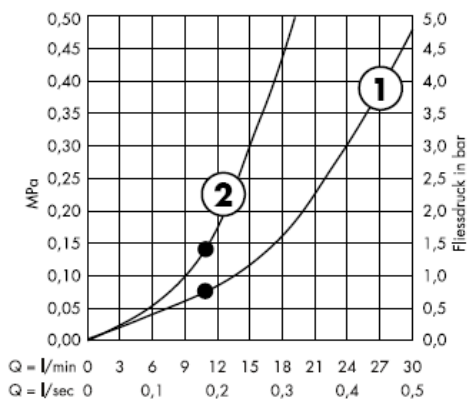

Od • je delovanje zagotovljeno.

① Normalen curek

Carlton / Montreux
28474XXX

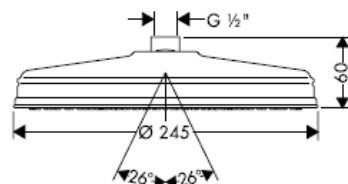

② Jet de pluie + Limiteur de débit

Carlton / Montreux
28487XXX

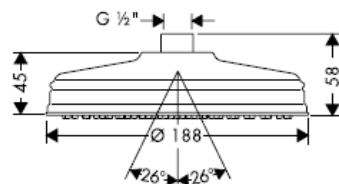

Citterio
28489000

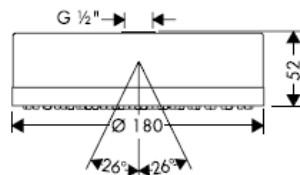

Montaža

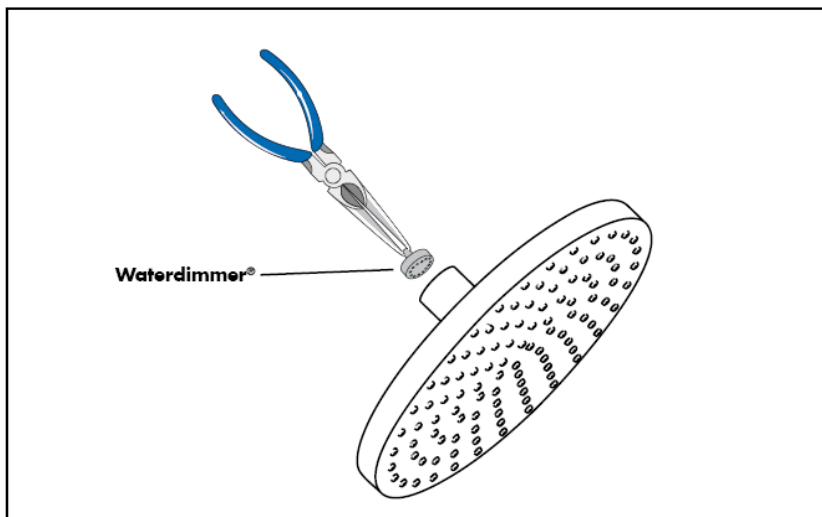
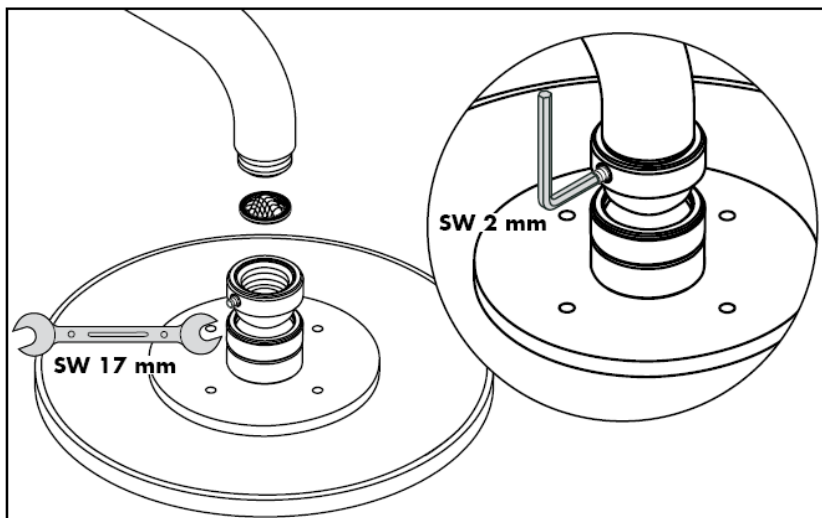

Filter, ki je priložen ročni prhi, je potrebno vgraditi, da prho zaščitimo pred umazanijo iz vodovodne napeljave. Umazanija lahko okvari ali poškoduje dele ročne prhe. Za tako nastalo škodo Hansgrohe ne odgovarja.

Terrano
28484XXX

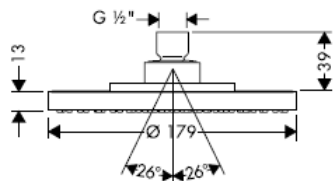

Terrano
28485XXX

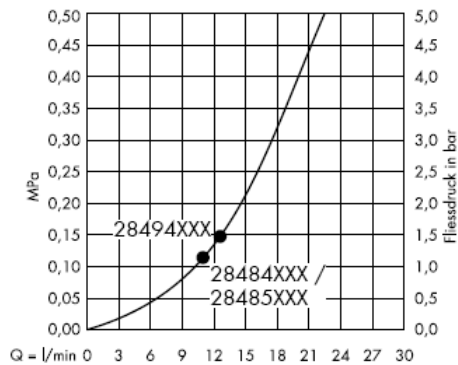
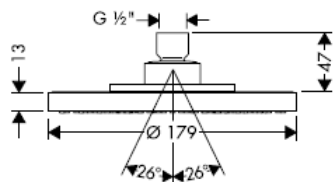

Od • je delovanje zagotovljeno.

Starck/Steel/Uno Air
28494XXX

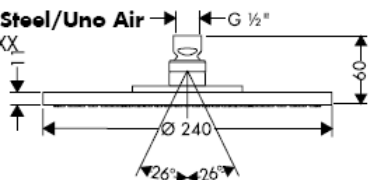

Montaža

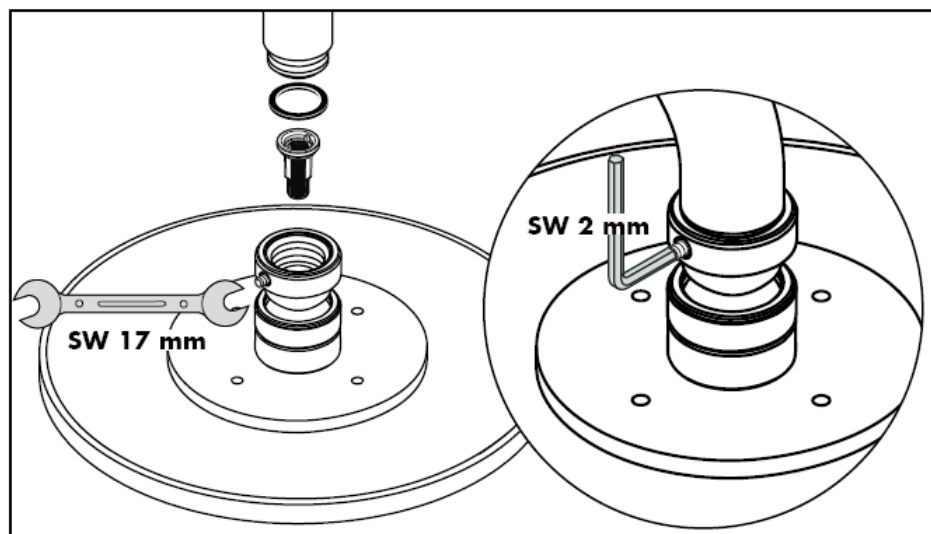

Filter, ki je priložen ročni prhi, je potrebno vgraditi, da prho zaščitimo pred umazanijo iz vodovodne napeljave. Umazanija lahko okvari ali poškoduje dele ročne prhe. Za tako nastalo škodo Hansgrohe ne odgovarja.

Čiščenje

Z Rubit®, ročno čistilno funkcijo, lahko s šob očistimo vodni kamen tako, da šobe enostavno podrgemo.

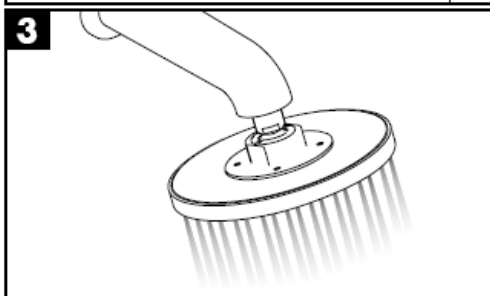
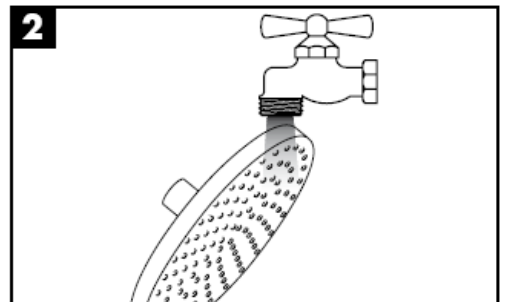
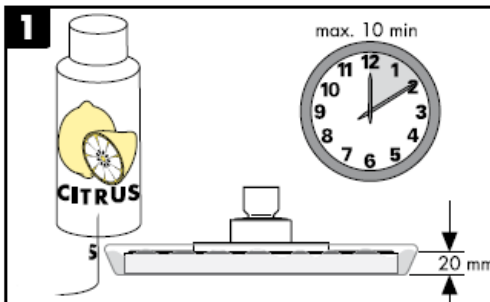
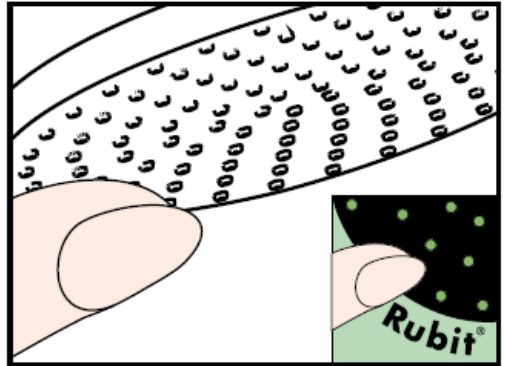

hansgrohe

Paigaldusjuhend

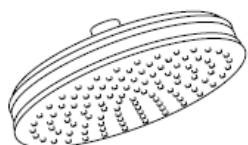

Carlton/Montreux
28474XXX/28487XXX

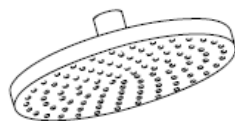

Terrano
28484XXX/28485XXX

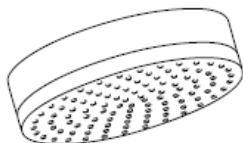

Citterio
28489000

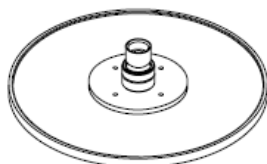

**Starck/Steel/Uno
Air**
28494XXX

AXOR[®]

hansgrohe

Hansgrohe ülepeaduše võib kasutada koos hüdrauliliselt ja termiliselt juhitavate boileritega, kui vee rõhk on vähemalt 0,15 MPa.

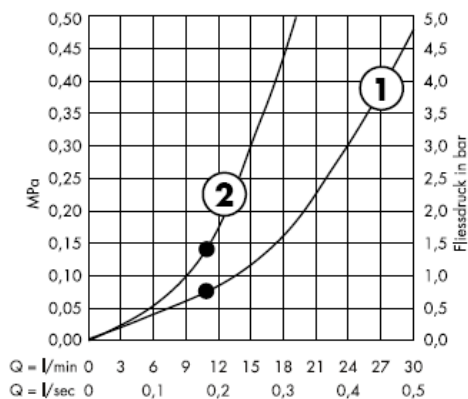

Alates • on funktsioneerimine garanteeritud

1 tavajuga

Carlton / Montreux
28474XXX

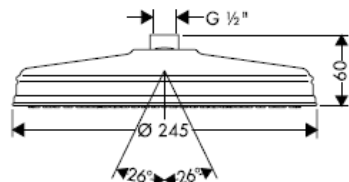

2 Tavajuga + Waterdimmer® (läbivoolu piiraja)

Carlton / Montreux
28487XXX

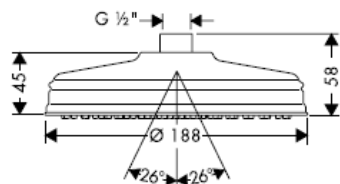

Citterio
28489000

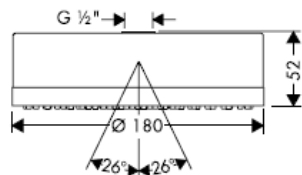

Paigaldamine

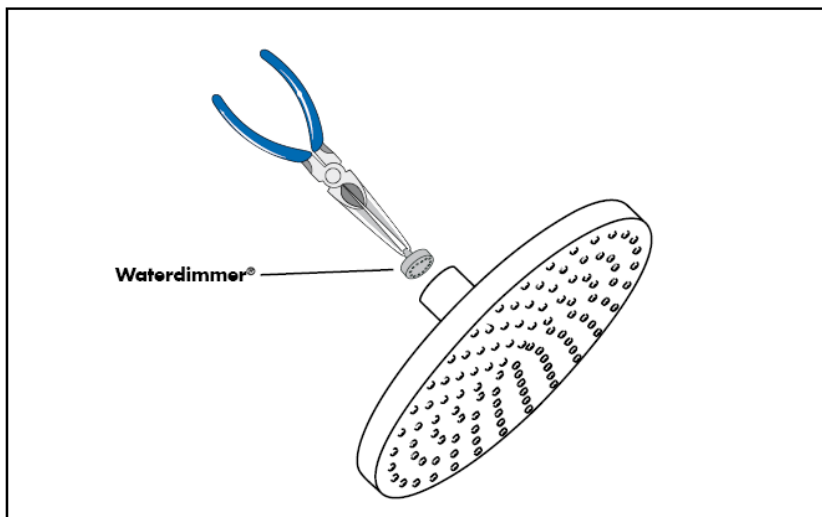
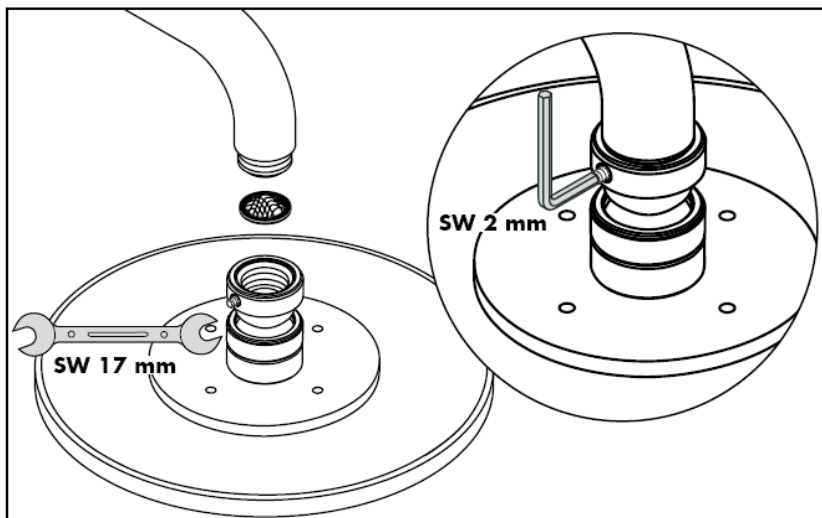

Kaitsmaks dušši torust tuleva mustuse eest, on vaja paigaldada dušiga kaasasolev mustusesõel. Sissetulev mustus võib funktsioneerimist kahjustada ja/või rikkuda dušši detaile. Sellest tulenevate kahjude eest Hansgrohe ei vastuta.

Terrano
28484XXX

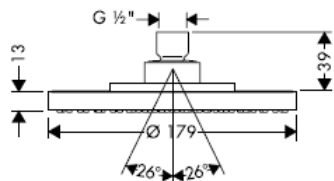

Terrano
28485XXX

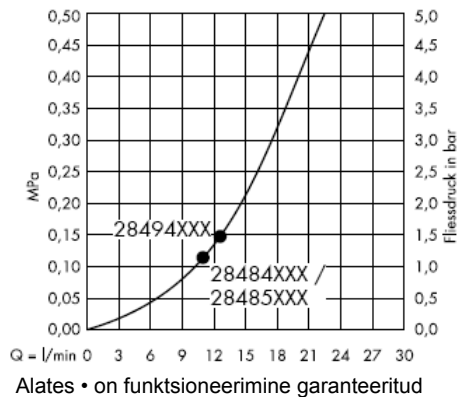
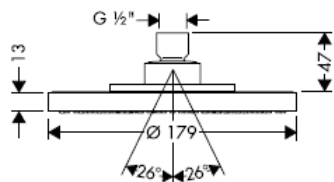

Starck/Steel/Uno Air
28494XXX

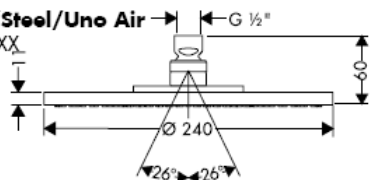

Paigaldamine

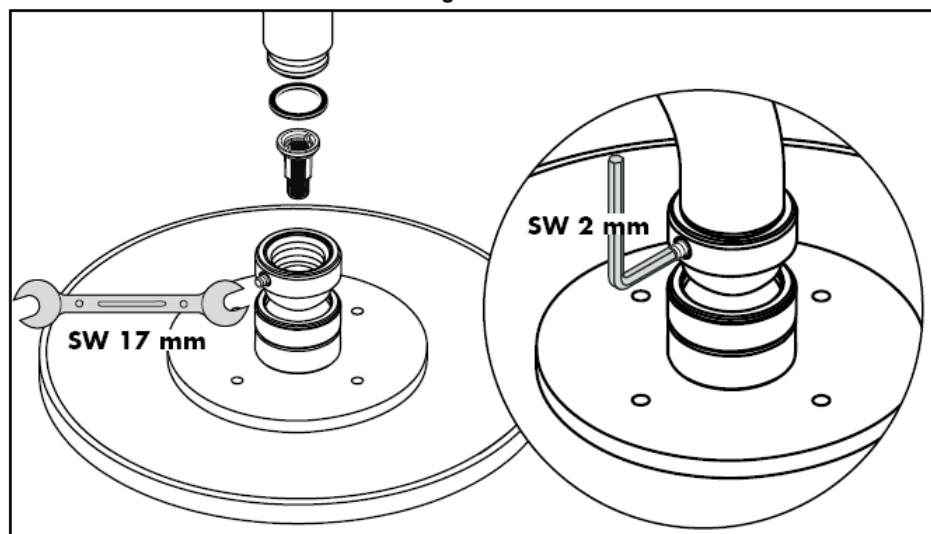

Kaitsmaks dušši torust tuleva mustuse eest, on vaja paigaldada dušiga kaasasolev mustusesõel. Sissetulev mustus võib funktsioneerimist kahjustada ja/või rikkuda duši detaile. Sellest tulenevate kahjude eest Hansgrohe ei vastuta.

Puhastamine

Käsitsi puhastamise funktsiooni Rubit® puhul on vajalik vaid kerge ülehõõrumine, eemaldamaks dušikanalitest katlakivi.

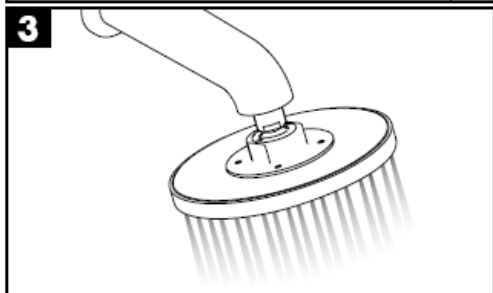
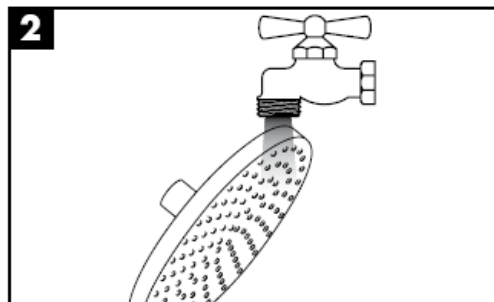
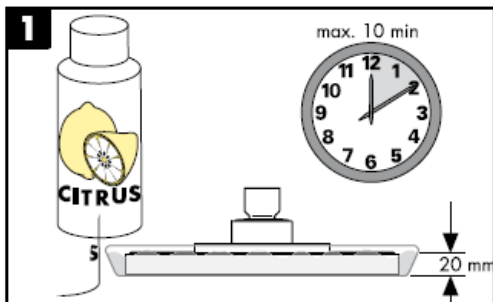
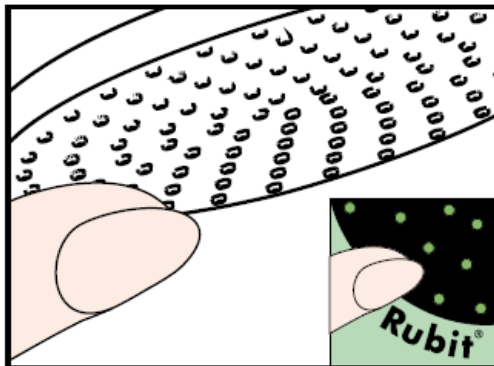

hansgrohe

Montāžas instrukcija

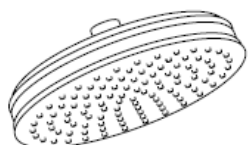

Carlton/Montreux
28474XXX/28487XXX

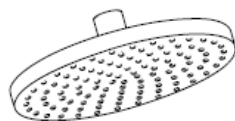

Terrano
28484XXX/28485XXX

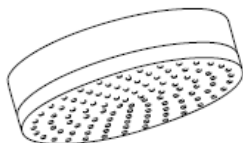

Citterio
28489000

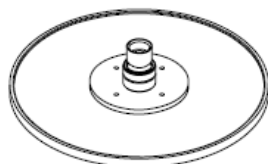

**Starck/Steel/Uno
Air**
28494XXX

AXOR[®]

hansgrohe

Hansgrohe dušas var izmantot kombinācijā ar hidrauliski un termiski vadāmiem caurteces sildītājiem, ja plūsmas spiediens ir vismaz 0,15 MPa.

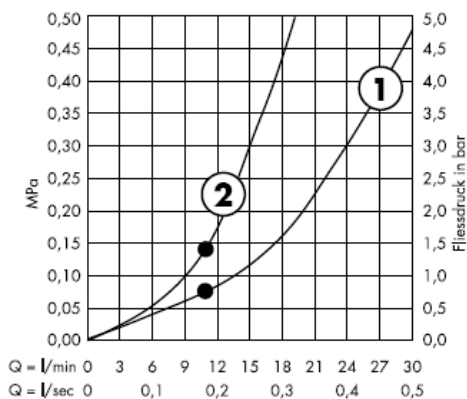

No • funkcija nodrošināta

1 Standarta strūkla

Carlton / Montreux
28474XXX

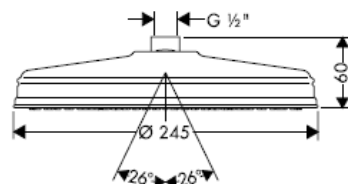

2 Standarta strūkla + Waterdimmer® (caurteces ierobežotājs)

Carlton / Montreux
28487XXX

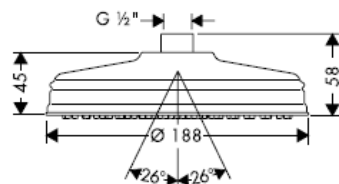

Citterio
28489000

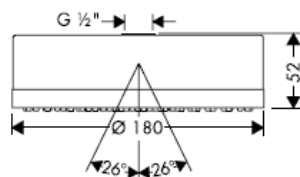

Montāža

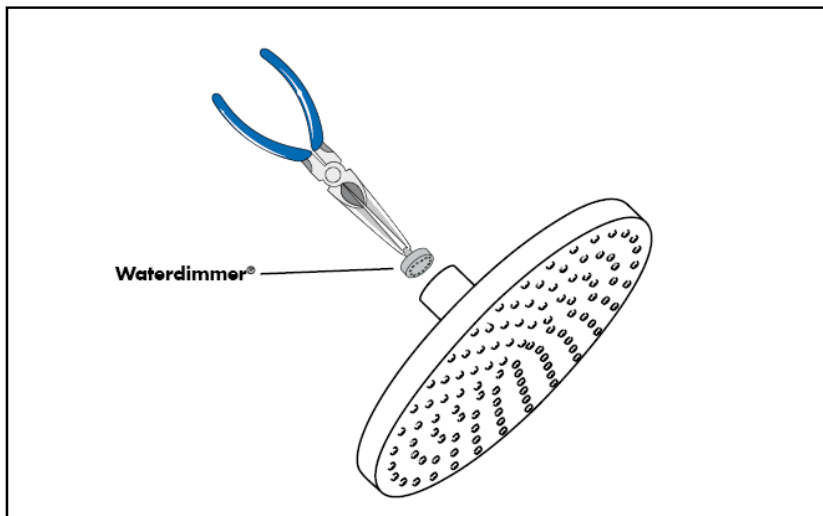
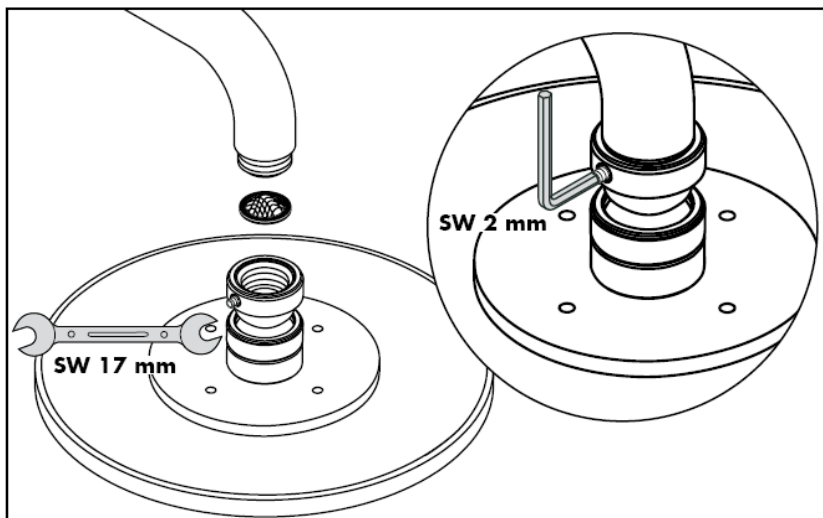

Jāiemonē dušas komplektā esošais filtrs, lai novērstu netīrumu ieplūšanu no ūdens vada. Ieskalotie netīrumi var traucēt dušas funkciju un / vai arī izraisīt rokas dušas daļu bojājumus, par kuriem Hansgrohe nenes atbildību.

Terrano
28484XXX

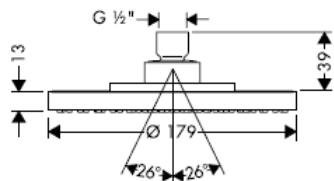

Terrano
28485XXX

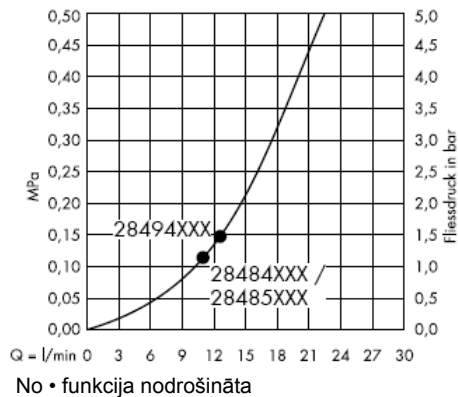
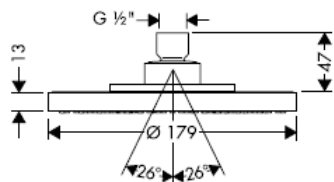

Starck/Steel/Uno Air
28494XXX

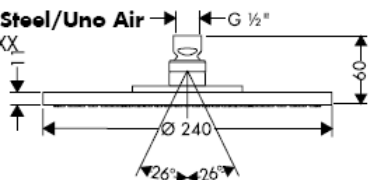

Montāža

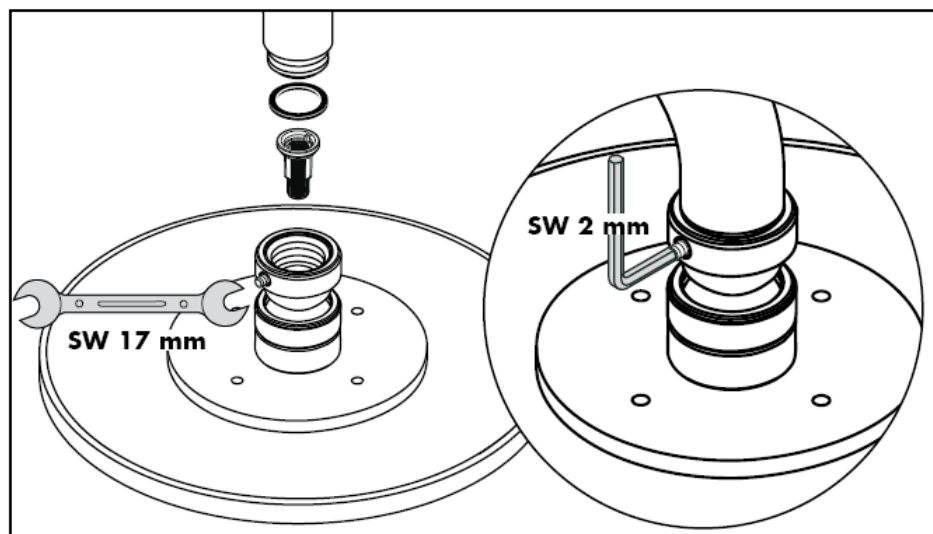

Jāņem vērā, ka dušas komplektā esošais filtrs, lai novērstu netīrumu ieplūšanu no ūdens vada, ieskaitot netīrumus, var traucēt dušas funkciju un / vai arī izraisīt rokas dušas daļu bojājumus, par kuriem Hansgrohe nenes atbildību.

Tīrīšana

Rubit® attīrīšanas funkcija - strūklas kanāliņi vienkāršas manuālas berzes rezultātā tiek attīrīti no kaļķa.

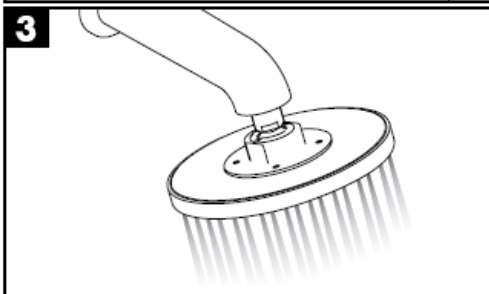
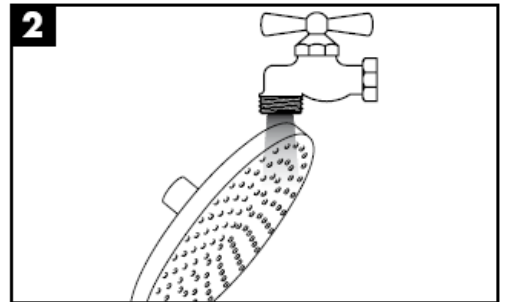
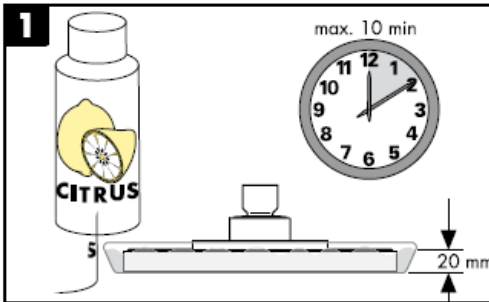
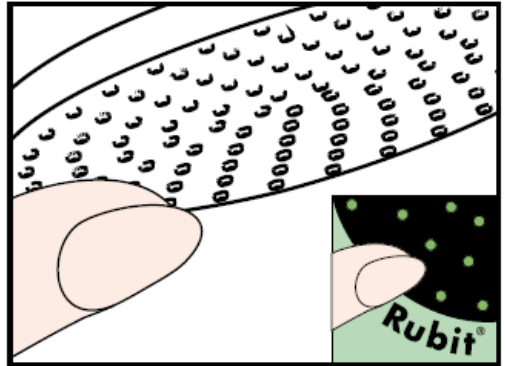

hansgrohe

Uputstvo za montažu

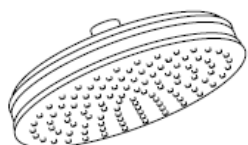

Carlton/Montreux
28474XXX/28487XXX

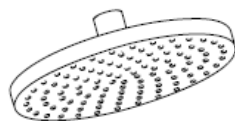

Terrano
28484XXX/28485XXX

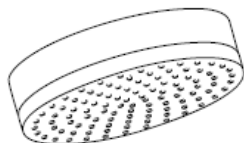

Citterio
28489000

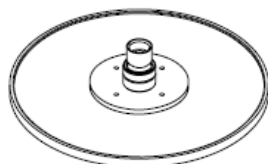

**Starck/Steel/Uno
Air**
28494XXX

AXOR[®]

hansgrohe

Hansgrohe tuševi se mogu koristiti u kombinaciji s hidraulički i termički kontrolisanim protočnim bojlerima ukoliko pritisak iznosi najmanje 0,15 MPa.

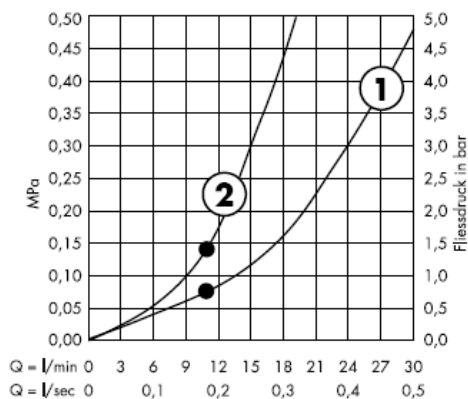

Od • je funkcija zagarantovana.

1 Normalni mlaz

Carlton / Montreux
28474XXX

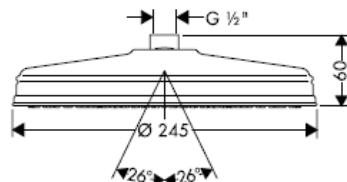

2 Normalni mlaz + Waterdimmer (ograničavač protoka)

Carlton / Montreux
28487XXX

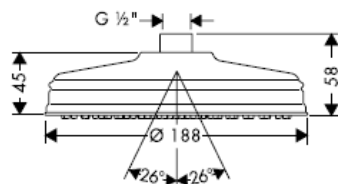

Citterio
28489000

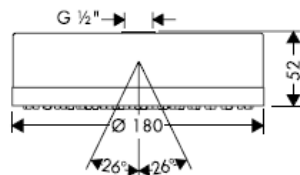

Montaža

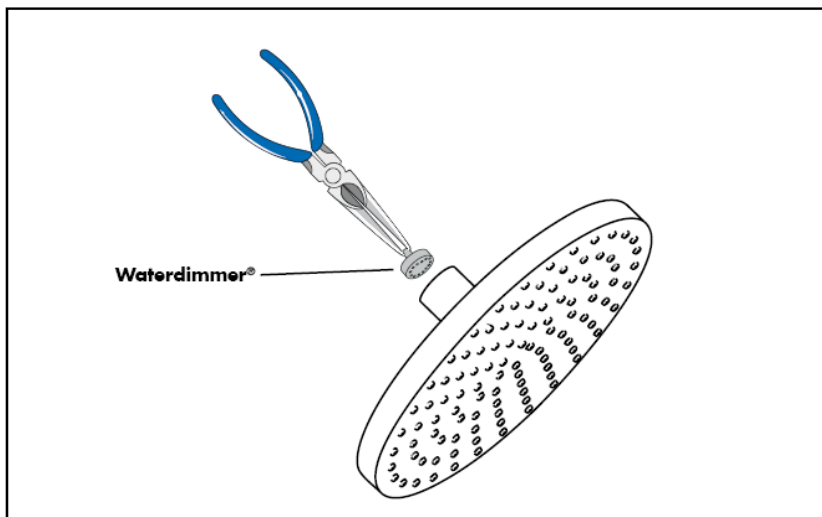
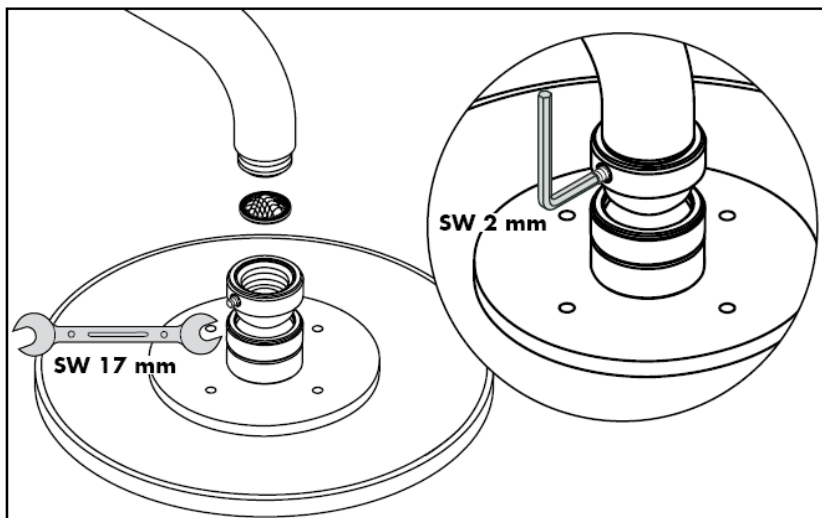

Obavezno ugradite mrežicu (A) upakovanu s tušem, čime sprečavate ulazak prljavštine iz vodovoda. Prljavština može dovesti do delimičnog ili potpunog oštećenja delova tuša. Za eventualna oštećenja uzrokovana prljavštinom proizvođač Hansgrohe nije odgovoran.

Terrano
28484XXX

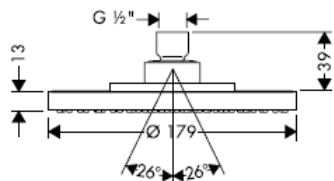

Terrano
28485XXX

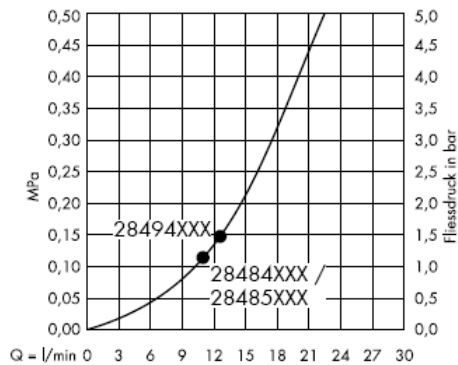
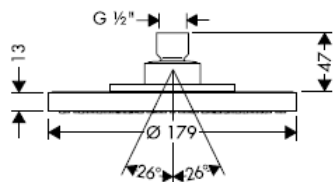

Od • je funkcija zagarantovana.

Starck/Steel/Uno Air
28494XXX

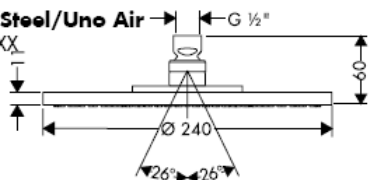

Montaža

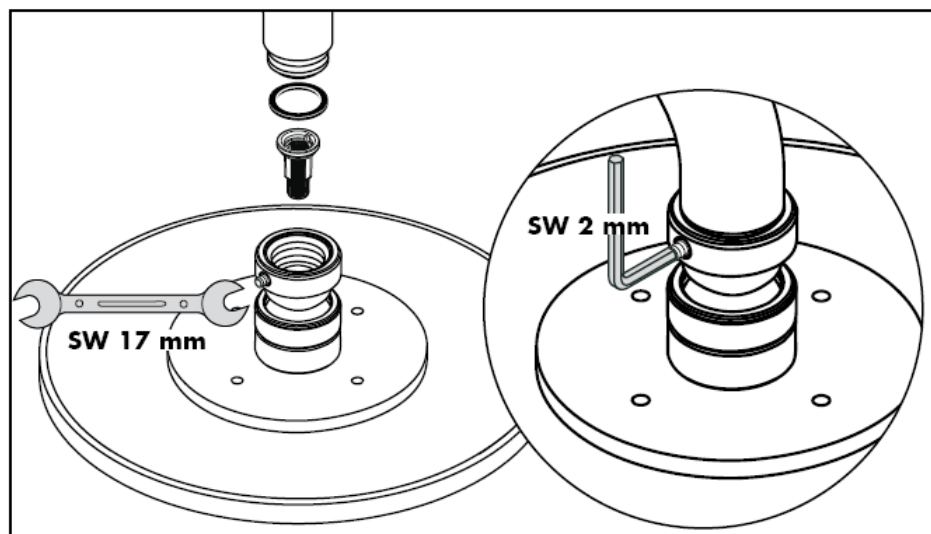

Obavezno ugradite mrežicu (A) upakovanu s tušem, čime sprečavate ulazak prljavštine iz vodovoda. Prljavština može dovesti do delimičnog ili potpunog oštećenja delova tuša. Za eventualna oštećenja uzrokovana prljavštinom proizvođač Hansgrohe nije odgovoran.

Čišćenje

Rubit® - ručni sistem za čišćenje omogućuje odstranjivanje kamenca s rupica uobličavača mlaza, jednostavnim trljanjem.

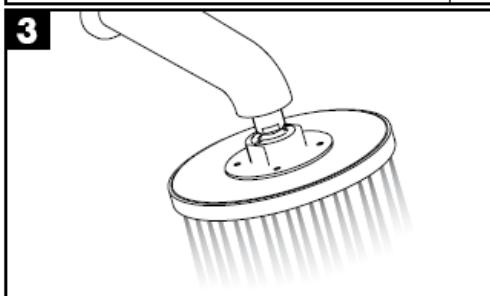
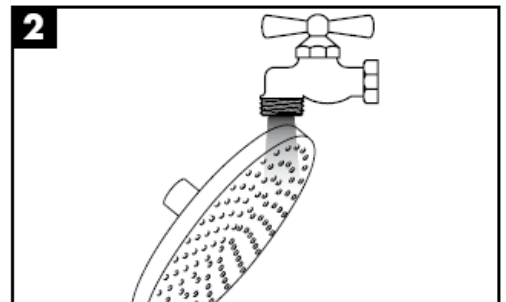
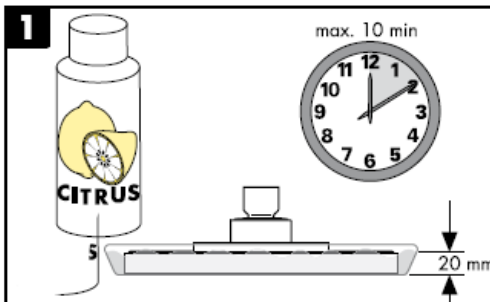
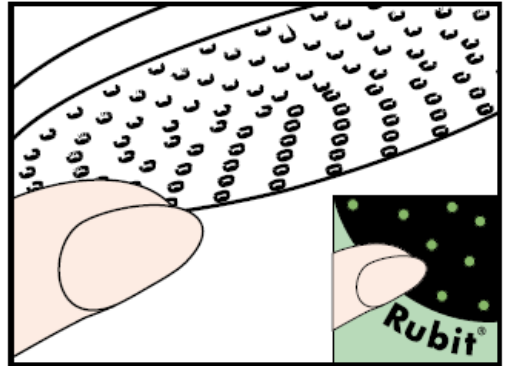

hansgrohe

Montasjeveiledning

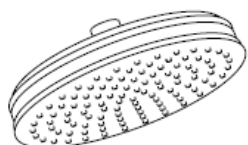

Carlton/Montreux
28474XXX/28487XXX

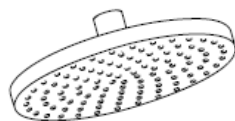

Terrano
28484XXX/28485XXX

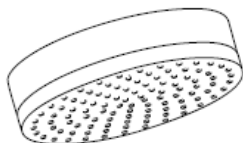

Citterio
28489000

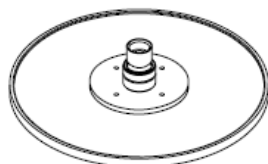

**Starck/Steel/Uno
Air**
28494XXX

AXOR[®]

hansgrohe

Armaturer fra Hansgrohe kan brukes sammen med hydraulisk og termisk strypte gjennomstrømningsovner når gjennomstrømningsstrykket før armaturen er på minst 0,15 MPa.

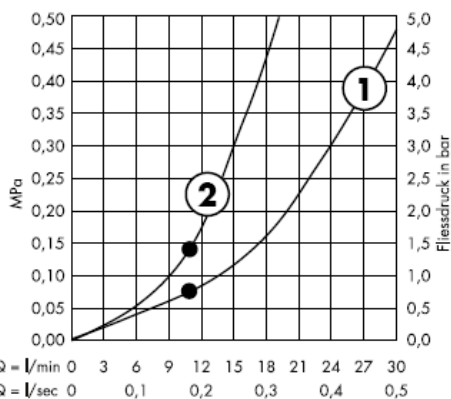

F.o.m. • er funksjonen garantert

1 Normalstråle

Carlton / Montreux
28474XXX

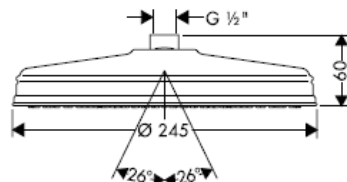

2 Normalstråle + Waterdimmer® (gjennomstrømningsbegrenser)

Carlton / Montreux
28487XXX

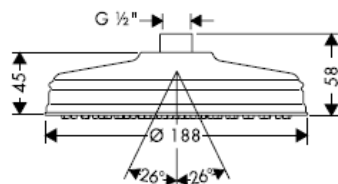

Citterio
28489000

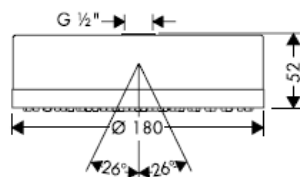

Montasje

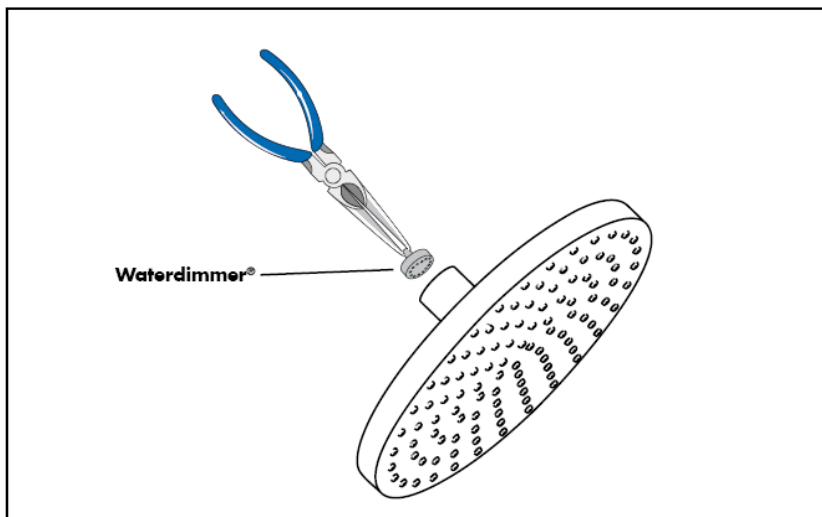
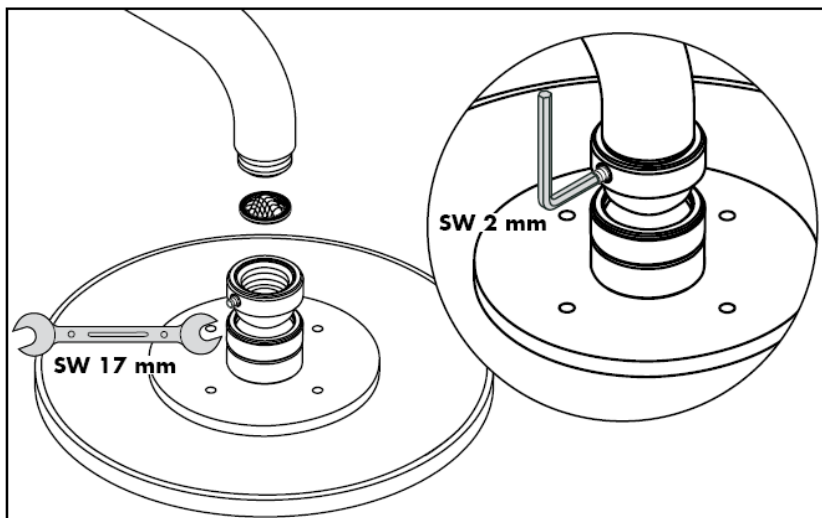

Silpakningen som er levert med dusjen skal bygges inn for å forhindre at smuss spyles inn fra ledningsnett. Innspylt smuss kan påvirke funksjonen negativt og/eller kan medføre skader på hånddusjens funksjonsdeler. Hansgrohe påtar seg inget ansvar for skader som resulteres av dette.

Terrano
28484XXX

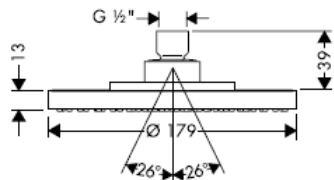

Terrano
28485XXX

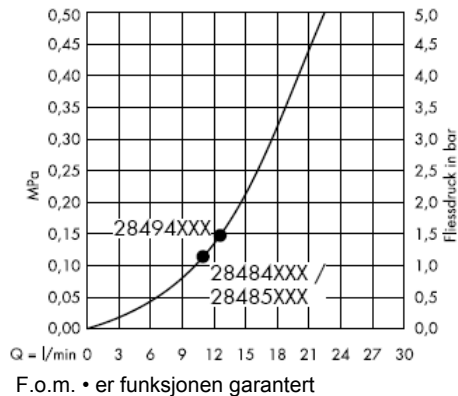
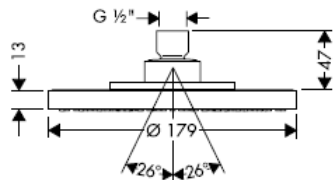

Starck/Steel/Uno Air
28494XXX

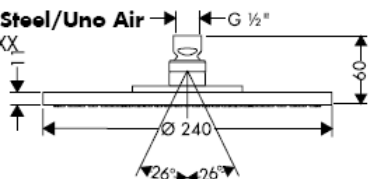

Montasje

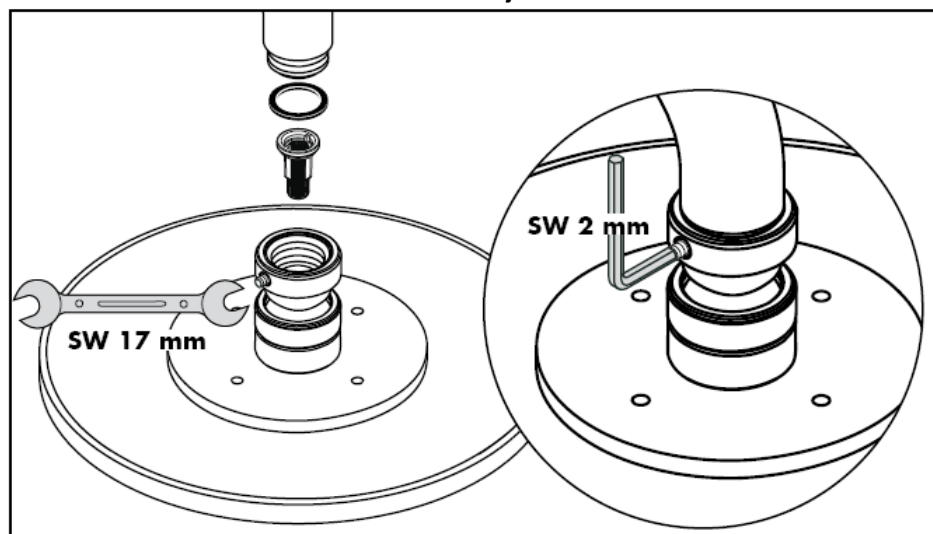

Medlevert filterinnsats skal bygges inn for å unngå smussinnspylinger fra ledningsnett. Smussinnspylinger kan påvirke funksjonen negativt og/eller medføre skader på dusjens funksjonsdeler. For skader som resulteres av dette påtar seg Hansgrohe inget ansvar.

Rengjøring

Ved hjelp av Rubit®, en manuell rengjøringsfunksjon, kan man fjerne kalk fra stråleformere ved enkel gnikking.

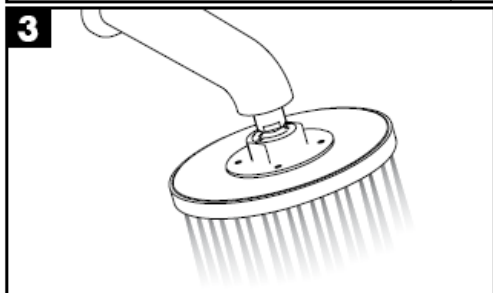
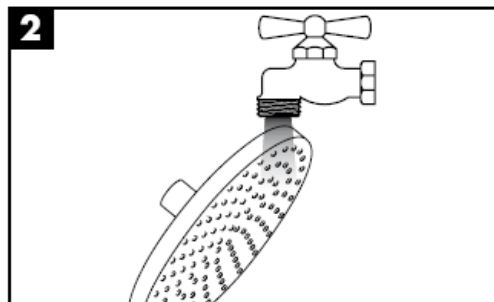
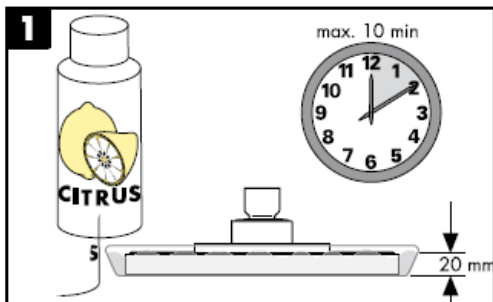
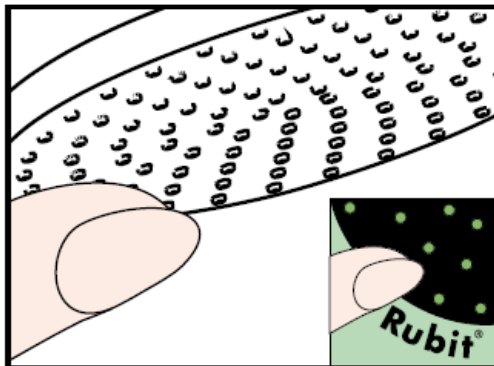

hansgrohe

РЪКОВОДСТВО ЗА МОНТАЖ

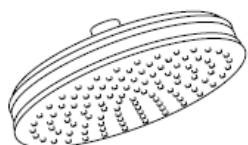

Carlton/Montreux
28474XXX/28487XXX

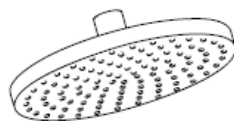

Terrano
28484XXX/28485XXX

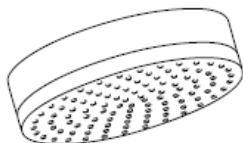

Citterio
28489000

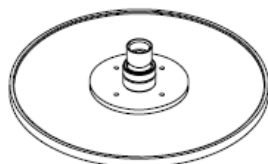

**Starck/Steel/Uno
Air**
28494XXX

AXOR[®]

hansgrohe

Разпръсквателите на Hansgrohe могат да се използват във връзка с хидравлично и термично управляеми проточни нагреватели, ако хидравличното налягане на арматурата е минимум 0,15 МПа.

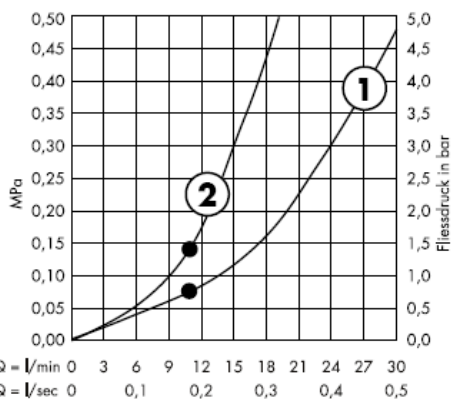

От • функцията е гарантирана.

1 Нормална струя

Carlton / Montreux
28474XXX

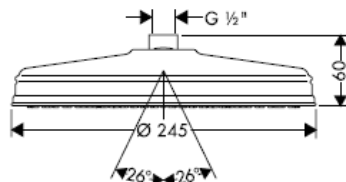

2 Нормална струя + Waterdimmer® (ограничител на протичане)

Carlton / Montreux
28487XXX

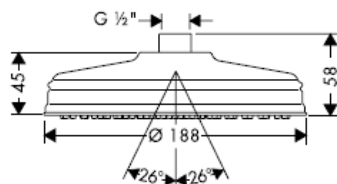

Citterio
28489000

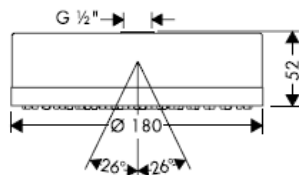

Монтаж

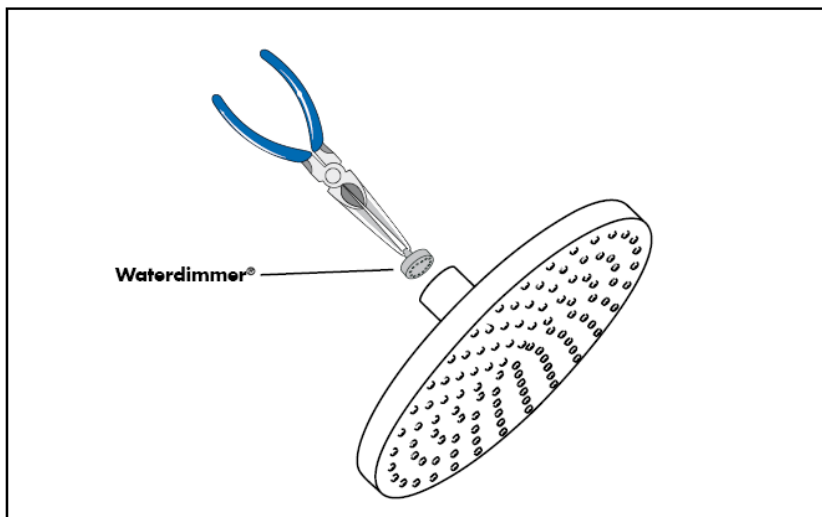
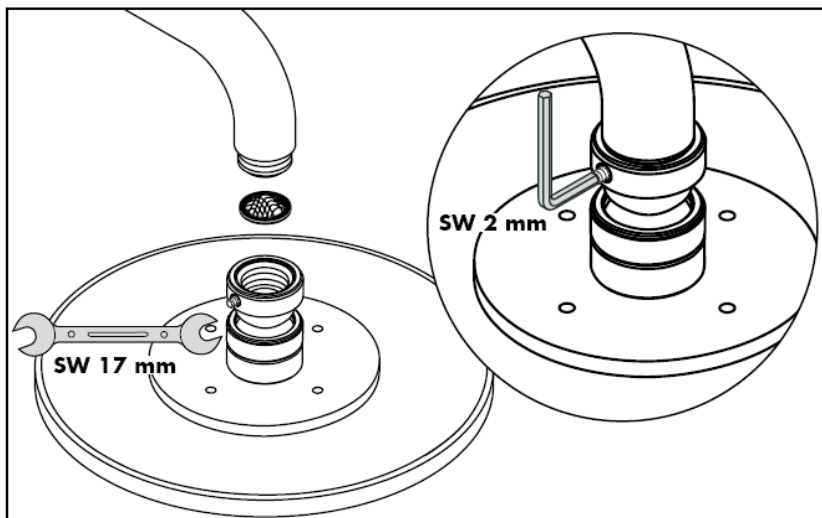

Опакованото заедно с разпръскателя уплътнение с цедка трябва да се монтира, за да се избегне натрупване на замърсявания от водопроводната мрежа. Натрупването на замърсявания може да наруши функцията и/или да доведе до увреждания на функционалните части на разпръскателя, Hansgrohe не носи отговорност за получените се по този начин щети.

Terrano
28484XXX

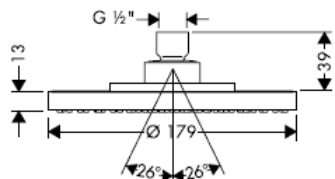

Terrano
28485XXX

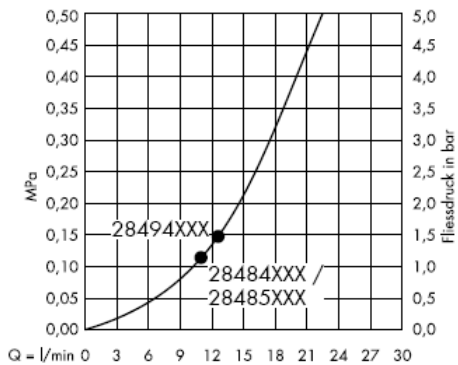
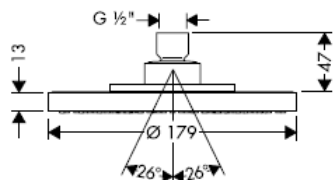

От • функцията е гарантирана.

Starck/Steel/Uno Air
28494XXX

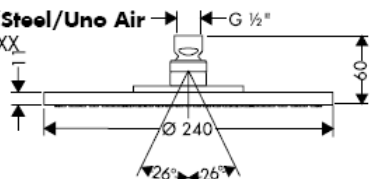

Монтаж

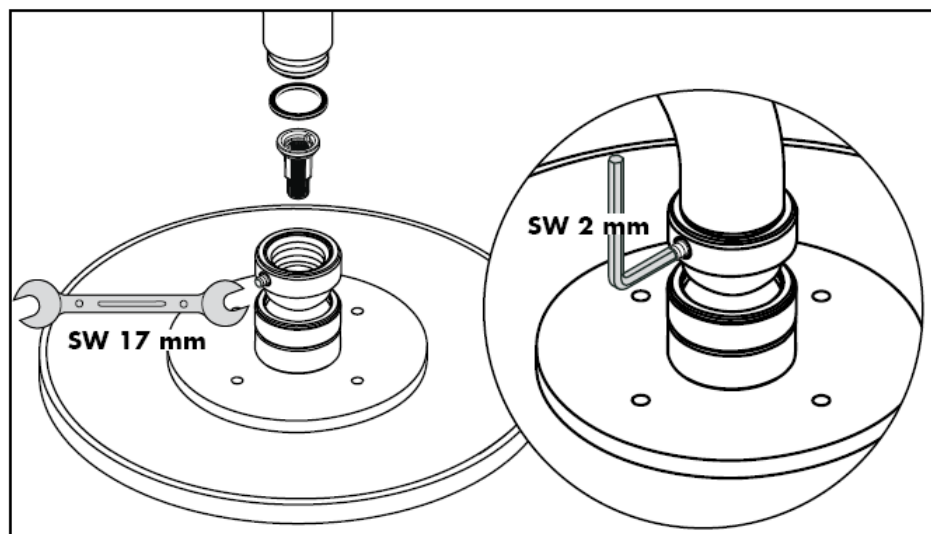

Приложената в опаковката филтърна вложка трябва да се монтира, за да се избегне натрупване на замърсявания от водопроводната мрежа. Натрупването на замърсявания може да наруши функцията и/или да доведе до увреждания на функционалните части на разпръсквателя, Hansgrohe не носи отговорност за получените се по този начин щети.

Почистване

С Rubit®, ръчната функция за почистване, приспособленията за почистване на струята могат да се почистват от варовика с просто разтъркване.

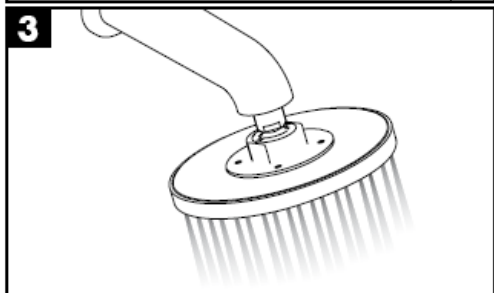
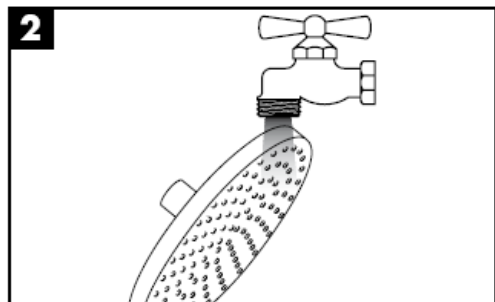
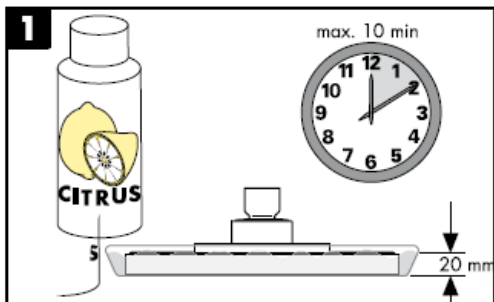
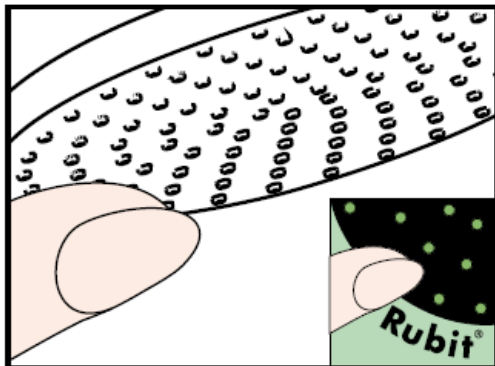

hansgrohe

Udhëzime rreth montimit

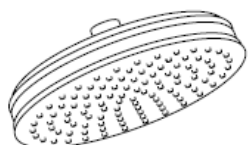

Carlton/Montreux
28474XXX/28487XXX

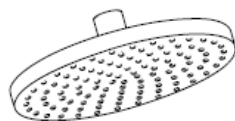

Terrano
28484XXX/28485XXX

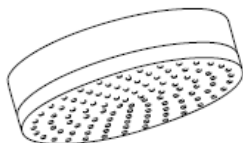

Citterio
28489000

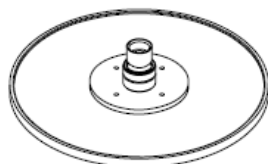

**Starck/Steel/Uno
Air**
28494XXX

AXOR[®]

hansgrohe

Armaturat e Hansgrohe mund të përdoren në kombinim me ngrohës elektrikë të ujit të drejtuar në mënyrë hidraulike ose termike nëse presioni i rrjedhjes para armaturës është minimumi 0,15 MPa.

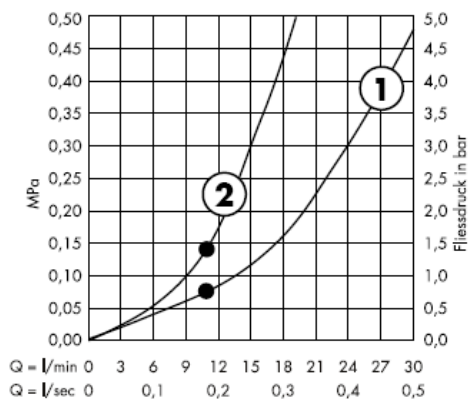

Nga • është i mundur funksioni.

1 Curril normal

Carlton / Montreux
28474XXX

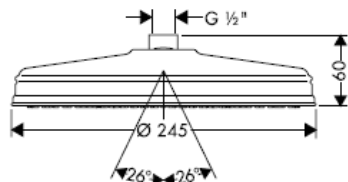

2 Curril normal + Waterdimmer® (Kufizues i rrjedhjes)

Carlton / Montreux
28487XXX

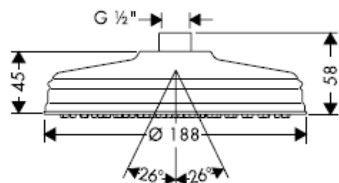

Citterio
28489000

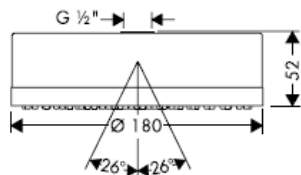

Montimi

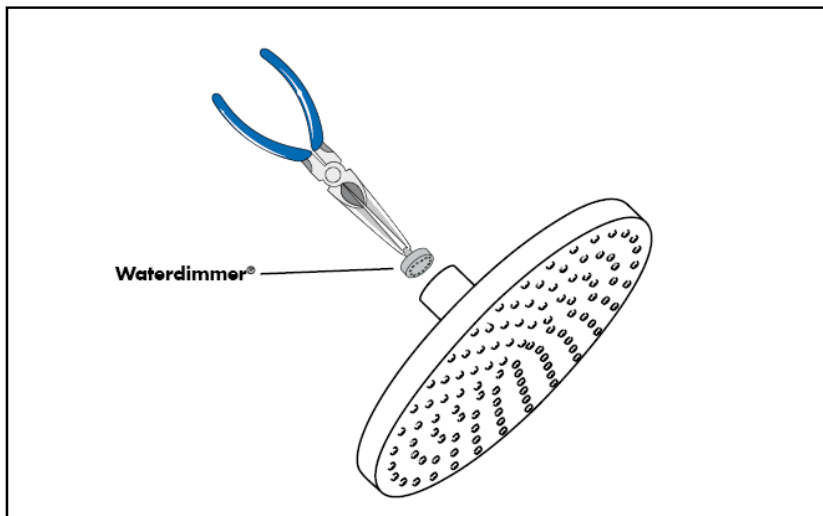
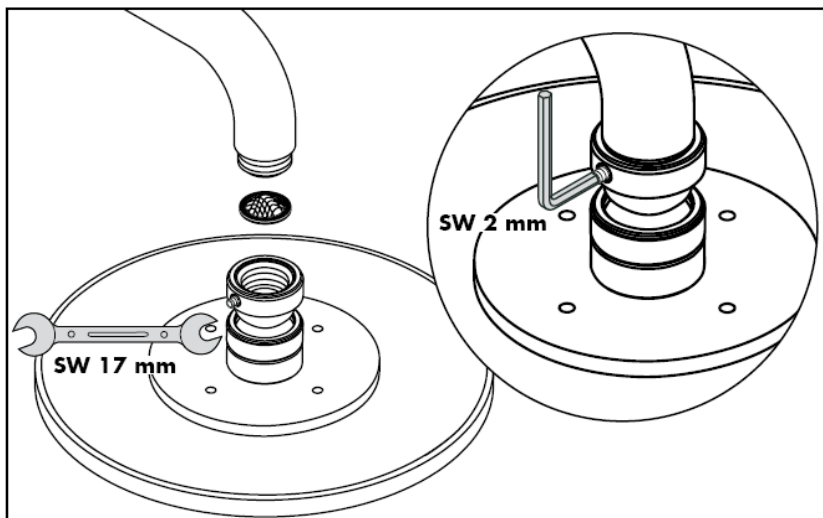

Sita që i kemi bashkëngjitur spërkatëses duhet përdorur për të evituar thithjen e papastërtive nga rrjeti i ujësllësit. Ndotjet mund të dëmtojnë pjesë funksionale të spërkatëses. Hansgrohe nuk merr përgjegjësinë për dëmet e shkaktuara në këtë mënyrë.

Terrano
28484XXX

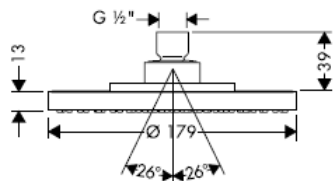

Terrano
28485XXX

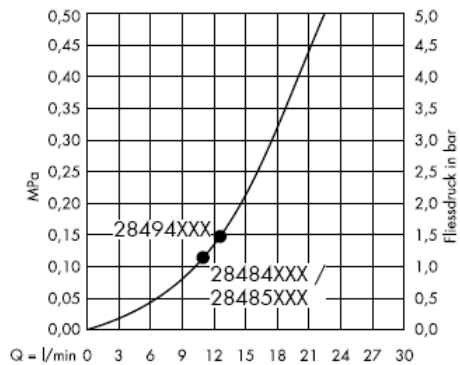
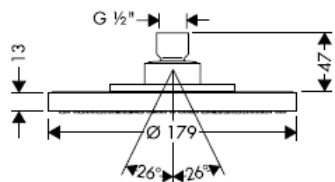

Nga • është i mundur funksioni.

Starck/Steel/Uno Air
28494XXX

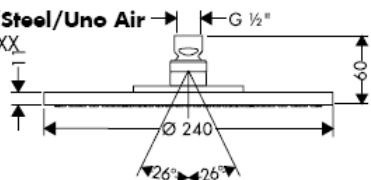

Montimi

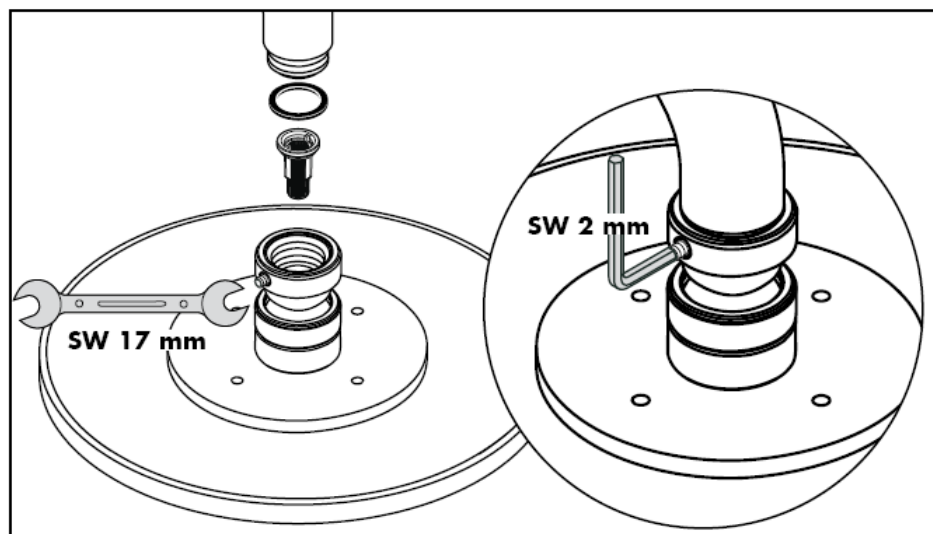

Filtri i bashkëngjitur duhet montuar për të evituar thithjen e ndotjeve nga rrjeti i ujësjellësit. Papastërtitë mund të dëmtojnë pjesë funksionale të dorezës. Hansgrohe nuk merr përgjegjësinë për dëmet e shkaktuara në këtë mënyrë.

Pastrimi

Me Rubit®, funksionin manual të pastrimit mund të hiqet kalku me fërkim të thjeshtë nga formuesit e currilit.

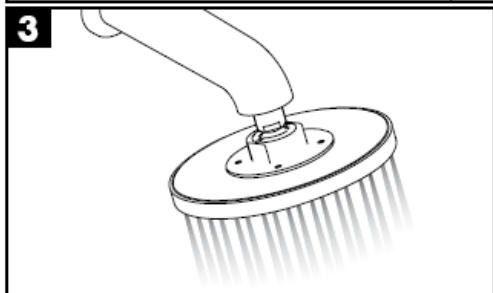
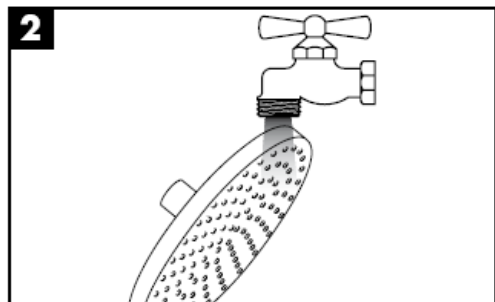
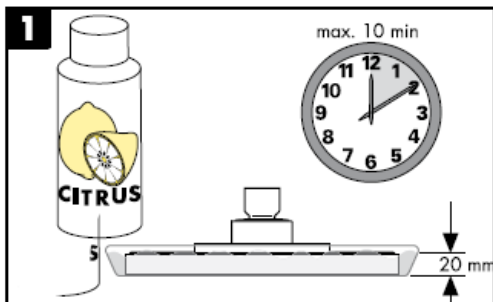
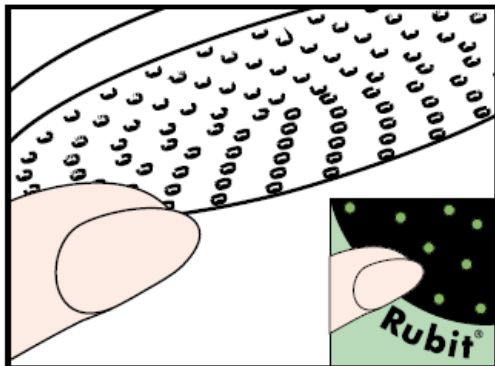

hansgrohe